



**DSL-G604T**  
**Wireless ADSL Router**  
**User's Guide**

---

---

(May 2005)

---

DSL604TEUA1

**FCC Warning**

This equipment has been tested and found to comply with the limits for a Class A digital device, pursuant to Part 15 of the FCC Rules. These limits are designed to provide reasonable protection against harmful interference when the equipment is operated in a commercial environment. This equipment generates, uses, and can radiate radio frequency energy and, if not installed and used in accordance with this user's guide, may cause harmful interference to radio communications. Operation of this equipment in a residential area is likely to cause harmful interference in which case the user will be required to correct the interference at his own expense.

**CE Mark Warning**

This is a Class A product. In a domestic environment, this product may cause radio interference in which case the user may be required to take adequate measures.

**Warnung!**

Dies ist ein Produkt der Klasse A. Im Wohnbereich kann dieses Produkt Funkstörungen verursachen. In diesem Fall kann vom Benutzer verlangt werden, angemessene Massnahmen zu ergreifen.

**Precaución!**

Este es un producto de Clase A. En un entorno doméstico, puede causar interferencias de radio, en cuyo caso, puede requerirse al usuario para que adopte las medidas adecuadas.

**Attention!**

Ceci est un produit de classe A. Dans un environnement domestique, ce produit pourrait causer des interférences radio, auquel cas l'utilisateur devrait prendre les mesures adéquates.

**Attenzione!**

Il presente prodotto appartiene alla classe A. Se utilizzato in ambiente domestico il prodotto può causare interferenze radio, nel cui caso è possibile che l'utente debba assumere provvedimenti adeguati.

# Warranty and Registration for all Countries and Regions Except USA

## Wichtige Sicherheitshinweise

1. Bitte lesen Sie sich diese Hinweise sorgfältig durch.
2. Heben Sie diese Anleitung für den spätern Gebrauch auf.
3. Vor jedem Reinigen ist das Gerät vom Stromnetz zu trennen. Verwenden Sie keine Flüssig- oder Aerosolreiniger. Am besten dient ein angefeuchtetes Tuch zur Reinigung.
4. Um eine Beschädigung des Gerätes zu vermeiden sollten Sie nur Zubehörteile verwenden, die vom Hersteller zugelassen sind.
5. Das Gerät ist vor Feuchtigkeit zu schützen.
6. Bei der Aufstellung des Gerätes ist auf sichern Stand zu achten. Ein Kippen oder Fallen könnte Verletzungen hervorrufen. Verwenden Sie nur sichere Standorte und beachten Sie die Aufstellhinweise des Herstellers.
7. Die Belüftungsöffnungen dienen zur Luftzirkulation die das Gerät vor Überhitzung schützt. Sorgen Sie dafür, daß diese Öffnungen nicht abgedeckt werden.
8. Beachten Sie beim Anschluß an das Stromnetz die Anschlußwerte.
9. Die Netzanschlußsteckdose muß aus Gründen der elektrischen Sicherheit einen Schutzleiterkontakt haben.
10. Verlegen Sie die Netzanschlußleitung so, daß niemand darüber fallen kann. Es sollte auch nichts auf der Leitung abgestellt werden.
11. Alle Hinweise und Warnungen die sich am Geräten befinden sind zu beachten.
12. Wird das Gerät über einen längeren Zeitraum nicht benutzt, sollten Sie es vom Stromnetz trennen. Somit wird im Falle einer Überspannung eine Beschädigung vermieden.
13. Durch die Lüftungsöffnungen dürfen niemals Gegenstände oder Flüssigkeiten in das Gerät gelangen. Dies könnte einen Brand bzw. Elektrischen Schlag auslösen.
14. Öffnen Sie niemals das Gerät. Das Gerät darf aus Gründen der elektrischen Sicherheit nur von autorisiertem Servicepersonal geöffnet werden.
15. Wenn folgende Situationen auftreten ist das Gerät vom Stromnetz zu trennen und von einer qualifizierten Servicestelle zu überprüfen:
  - a. Netzkabel oder Netzstecker sind beschädigt.
  - b. Flüssigkeit ist in das Gerät eingedrungen.
  - c. Das Gerät war Feuchtigkeit ausgesetzt.
  - d. Wenn das Gerät nicht der Bedienungsanleitung entsprechend funktioniert oder Sie mit Hilfe dieser Anleitung keine Verbesserung erzielen.
  - e. Das Gerät ist gefallen und/oder das Gehäuse ist beschädigt.
  - f. Wenn das Gerät deutliche Anzeichen eines Defektes aufweist.
16. Bei Reparaturen dürfen nur Originalersatzteile bzw. den Originalteilen entsprechende Teile verwendet werden. Der Einsatz von ungeeigneten Ersatzteilen kann eine weitere Beschädigung hervorrufen.
17. Wenden Sie sich mit allen Fragen die Service und Reparatur betreffen an Ihren Servicepartner. Somit stellen Sie die Betriebssicherheit des Gerätes sicher.
18. Zum Netzanschluß dieses Gerätes ist eine geprüfte Leitung zu verwenden, Für einen Nennstrom bis 6A und einem Gerätegewicht größer 3kg ist eine Leitung nicht leichter als H05VV-F, 3G, 0.75mm<sup>2</sup> einzusetzen.

## WARRANTIES EXCLUSIVE

IF THE D-LINK PRODUCT DOES NOT OPERATE AS WARRANTED ABOVE, THE CUSTOMER'S SOLE REMEDY SHALL BE, AT D-LINK'S OPTION, REPAIR OR REPLACEMENT. THE FOREGOING WARRANTIES AND REMEDIES ARE EXCLUSIVE AND ARE IN LIEU OF ALL OTHER WARRANTIES, EXPRESSED OR IMPLIED, EITHER IN FACT OR BY OPERATION OF LAW, STATUTORY OR OTHERWISE, INCLUDING WARRANTIES OF MERCHANTABILITY AND FITNESS FOR A PARTICULAR PURPOSE. D-LINK NEITHER ASSUMES NOR AUTHORIZES ANY OTHER PERSON TO ASSUME FOR IT ANY OTHER LIABILITY IN CONNECTION WITH THE SALE, INSTALLATION MAINTENANCE OR USE OF D-LINK'S PRODUCTS.

D-LINK SHALL NOT BE LIABLE UNDER THIS WARRANTY IF ITS TESTING AND EXAMINATION DISCLOSE THAT THE ALLEGED DEFECT IN THE PRODUCT DOES NOT EXIST OR WAS CAUSED BY THE CUSTOMER'S OR ANY THIRD PERSON'S MISUSE, NEGLIGENCE, IMPROPER INSTALLATION OR TESTING, UNAUTHORIZED ATTEMPTS TO REPAIR, OR ANY OTHER CAUSE BEYOND THE RANGE OF THE INTENDED USE, OR BY ACCIDENT, FIRE, LIGHTNING OR OTHER HAZARD.

## LIMITATION OF LIABILITY

IN NO EVENT WILL D-LINK BE LIABLE FOR ANY DAMAGES, INCLUDING LOSS OF DATA, LOSS OF PROFITS, COST OF COVER OR OTHER INCIDENTAL, CONSEQUENTIAL OR INDIRECT DAMAGES ARISING OUT THE INSTALLATION, MAINTENANCE, USE, PERFORMANCE, FAILURE OR INTERRUPTION OF A D-LINK PRODUCT, HOWEVER CAUSED AND ON ANY THEORY OF LIABILITY. THIS LIMITATION WILL APPLY EVEN IF D-LINK HAS BEEN ADVISED OF THE POSSIBILITY OF SUCH DAMAGE. IF YOU PURCHASED A D-LINK PRODUCT IN THE UNITED STATES, SOME STATES DO NOT ALLOW THE LIMITATION OR EXCLUSION OF LIABILITY FOR INCIDENTAL OR CONSEQUENTIAL DAMAGES, SO THE ABOVE LIMITATION MAY NOT APPLY TO YOU.

## Limited Warranty

### Hardware:

D-Link warrants each of its hardware products to be free from defects in workmanship and materials under normal use and service for a period commencing on the date of purchase from D-Link or its Authorized Reseller and extending for the length of time stipulated by the Authorized Reseller or D-Link Branch Office nearest to the place of purchase.

This Warranty applies on the condition that the product Registration Card is filled out and returned to a D-Link office within ninety (90) days of purchase. A list of D-Link offices is provided at the back of this manual, together with a copy of the Registration Card.

If the product proves defective within the applicable warranty period, D-Link will provide repair or replacement of the product. D-Link shall have the sole discretion whether to repair or replace, and replacement product may be new or reconditioned. Replacement product shall be of equivalent or better specifications, relative to the defective product, but need not be identical. Any product or part repaired by D-Link pursuant to this warranty shall have a warranty period of not less than 90 days, from date of such repair, irrespective of any earlier expiration of original warranty period. When D-Link provides replacement, then the defective product becomes the property of D-Link.

Warranty service may be obtained by contacting a D-Link office within the applicable warranty period, and requesting a Return Material Authorization (RMA) number. If a Registration Card for the product in question has not been returned to D-Link, then a proof of purchase (such as a copy of the dated purchase invoice) must be provided. If Purchaser's circumstances require special handling of warranty correction, then at the time of requesting RMA number, Purchaser may also propose special procedure as may be suitable to the case.

After an RMA number is issued, the defective product must be packaged securely in the original or other suitable shipping package to ensure that it will not be damaged in transit, and the RMA number must be prominently marked on the outside of the package. The package must be mailed or otherwise shipped to D-Link with all costs of mailing/shipping/insurance prepaid. D-Link shall never be responsible for any software, firmware, information, or memory data of Purchaser contained in, stored on, or integrated with any product returned to D-Link pursuant to this warranty.

Any package returned to D-Link without an RMA number will be rejected and shipped back to Purchaser at Purchaser's expense, and D-Link reserves the right in such a case to levy a reasonable handling charge in addition mailing or shipping costs.

### Software:

Warranty service for software products may be obtained by contacting a D-Link office within the applicable warranty period. A list of D-Link offices is provided at the back of this manual, together with a copy of the Registration Card. If a Registration Card for the product in question has not been returned to a D-Link office, then a proof of purchase (such as a copy of the dated purchase invoice) must be provided when requesting warranty service. The term "purchase" in this software warranty refers to the purchase transaction and resulting license to use such software.

D-Link warrants that its software products will perform in substantial conformance with the applicable product documentation provided by D-Link with such software product, for a period of ninety (90) days from the date of purchase from D-Link or its Authorized Reseller. D-Link warrants the magnetic media, on which D-Link provides its software product, against failure during the same warranty period. This warranty applies to purchased software, and to replacement software provided by D-Link pursuant to this warranty, but shall not apply to any update or replacement which may be provided for download via the Internet, or to any update which may otherwise be provided free of charge.

D-Link's sole obligation under this software warranty shall be to replace any defective software product with product which substantially conforms to D-Link's applicable product documentation. Purchaser assumes responsibility for the selection of appropriate application and system/platform software and associated reference materials. D-Link makes no warranty that its software products will work in combination with any hardware, or any application or system/platform software product provided by any third party, excepting only such products as are expressly represented, in D-Link's applicable product documentation as being compatible. D-Link's obligation under this warranty shall be a reasonable effort to provide compatibility, but D-Link shall have no obligation to provide compatibility when there is fault in the third-party hardware or software. D-Link makes no warranty that operation of its software products will be uninterrupted or absolutely error-free, and no warranty that all defects in the software product, within or without the scope of D-Link's applicable product documentation, will be corrected.

## Warranty and Registration Information for USA Only

Subject to the terms and conditions set forth herein, D-Link Systems, Inc. ("D-Link") provides this Limited warranty for its product only to the person or entity that originally purchased the product from:

- D-Link or its authorized reseller or distributor and
- Products purchased and delivered within the fifty states of the United States, the District of Columbia, U.S. Possessions or Protectorates, and U.S. Military Installations, addresses with an APO or FPO.

**Limited Warranty:** D-Link warrants that the hardware portion of the D-Link products described below will be free from material defects in workmanship and materials from the date of original retail purchase of the product, for the period set forth below applicable to the product type ("Warranty Period"), except as otherwise stated herein.

5-Year Limited Warranty for the Product(s) is defined as follows:

- Hardware (excluding power supplies and fans) Five (5) Years
- Power Supplies and Fans Three (3) Year
- Spare parts and spare kits Ninety (90) days

D-Link's sole obligation shall be to repair or replace the defective Hardware during the Warranty Period at no charge to the original owner or to refund at D-Link's sole discretion. Such repair or replacement will be rendered by D-Link at an Authorized D-Link Service Office. The replacement Hardware need not be new or have an identical make, model or part. D-Link may in its sole discretion replace the defective Hardware (or any part thereof) with any reconditioned product that D-Link reasonably determines is substantially equivalent (or superior) in all material respects to the defective Hardware. Repaired or replacement Hardware will be warranted for the remainder of the original Warranty Period from the date of original retail purchase. If a material defect is incapable of correction, or if D-Link determines in its sole discretion that it is not practical to repair or replace the defective Hardware, the price paid by the original purchaser for the defective Hardware will be refunded by D-Link upon return to D-Link of the defective Hardware. All Hardware (or part thereof) that is replaced by D-Link, or for which the purchase price is refunded, shall become the property of D-Link upon replacement or refund.

**Limited Software Warranty:** D-Link warrants that the software portion of the product ("Software") will substantially conform to D-Link's then current functional specifications for the Software, as set forth in the applicable documentation, from the date of original retail purchase of the Software for a period of ninety (90) days ("Warranty Period"), provided that the Software is properly

installed on approved hardware and operated as contemplated in its documentation. D-Link further warrants that, during the Warranty Period, the magnetic media on which D-Link delivers the Software will be free of physical defects. D-Link's sole obligation shall be to replace the non-conforming Software (or defective media) with software that substantially conforms to D-Link's functional specifications for the Software or to refund at D-Link's sole discretion. Except as otherwise agreed by D-Link in writing, the replacement Software is provided only to the original licensee, and is subject to the terms and conditions of the license granted by D-Link for the Software. Software will be warranted for the remainder of the original Warranty Period from the date or original retail purchase. If a material non-conformance is incapable of correction, or if D-Link determines in its sole discretion that it is not practical to replace the non-conforming Software, the price paid by the original licensee for the non-conforming Software will be refunded by D-Link; provided that the non-conforming Software (and all copies thereof) is first returned to D-Link. The license granted respecting any Software for which a refund is given automatically terminates.

**Non-Applicability of Warranty:** The Limited Warranty provided hereunder for hardware and software of D-Link's products, will not be applied to and does not cover any product purchased through the inventory clearance or liquidation sale or other sales in which D-Link, the sellers, or the liquidators expressly disclaim their warranty obligation pertaining to the product and in that case, the product is being sold "As-Is" without any warranty whatsoever including, without limitation, the Limited Warranty as described herein, notwithstanding anything stated herein to the contrary.

**Submitting A Claim:** Any claim under this limited warranty must be submitted in writing before the end of the Warranty Period to an Authorized D-Link Service Office.

- The customer must submit as part of the claim a written description of the Hardware defect or Software nonconformance in sufficient detail to allow D-Link to confirm the same.
- The original product owner must obtain a Return Material Authorization ("RMA") number from the Authorized D-Link Service Office and, if requested, provide written proof of purchase of the product (such as a copy of the dated purchase invoice for the product) before the warranty service is provided.
- After an RMA number is issued, the defective product must be packaged securely in the original or other suitable shipping package to ensure that it will not be damaged in transit, and the RMA number must be prominently marked on the outside of the package. Do not include any manuals or accessories in the shipping package. D-Link will only replace the defective portion of the Product and will not ship back any accessories.
- The customer is responsible for all shipping charges to D-Link. No Charge on Delivery ("COD") is allowed. Products sent COD will either be rejected by D-Link or become the property of D-Link. Products should be fully insured by the customer and shipped to D-Link Systems, Inc., 53 Discovery Drive, Irvine, CA 92618. D-Link will not be held responsible for any packages that are lost in transit to D-Link. The repaired or replaced packages will be shipped via UPS Ground or any common carrier selected by D-Link, with shipping charges prepaid. Expedited shipping is available if shipping charges are prepaid by the customer.

D-Link may reject or return any product that is not packaged and shipped in strict compliance with the foregoing requirements, or for which an RMA number is not visible from the outside of the package. The product owner agrees to pay D-Link's reasonable handling and return shipping charges for any product that is not packaged and shipped in accordance with the foregoing requirements, or that is determined by D-Link not to be defective or non-conforming.

**What Is Not Covered:** This limited warranty provided by D-Link does not cover: Products, if in D-Link's judgment, have been subjected to abuse, accident, alteration, modification, tampering, negligence, misuse, faulty installation, lack of reasonable care, repair or service in any way that is not contemplated in the documentation for the product, or if the model or serial number has been altered, tampered with, defaced or removed; Initial installation, installation and removal of the product for repair, and shipping costs; Operational adjustments covered in the operating manual for the product, and normal maintenance; Damage that occurs in shipment, due to act of God, failures due to power surge, and cosmetic damage; Any hardware, software, firmware or other products or services provided by anyone other than D-Link; Products that have been purchased from inventory clearance or liquidation sales or other sales in which D-Link, the sellers, or the liquidators expressly disclaim their warranty obligation pertaining to the product. Repair by anyone other than D-Link or an Authorized D-Link Service Office will void this Warranty.

**Disclaimer of Other Warranties:** EXCEPT FOR THE LIMITED WARRANTY SPECIFIED HEREIN, THE PRODUCT IS PROVIDED "AS-IS" WITHOUT ANY WARRANTY OF ANY KIND WHATSOEVER INCLUDING, WITHOUT LIMITATION, ANY WARRANTY OF MERCHANTABILITY, FITNESS FOR A PARTICULAR PURPOSE AND NON-INFRINGEMENT. IF ANY IMPLIED WARRANTY CANNOT BE DISCLAIMED IN ANY TERRITORY WHERE A PRODUCT IS SOLD, THE DURATION OF SUCH IMPLIED WARRANTY SHALL BE LIMITED TO NINETY (90) DAYS. EXCEPT AS EXPRESSLY COVERED UNDER THE LIMITED WARRANTY PROVIDED HEREIN, THE ENTIRE RISK AS TO THE QUALITY, SELECTION AND PERFORMANCE OF THE PRODUCT IS WITH THE PURCHASER OF THE PRODUCT.

**Limitation of Liability:** TO THE MAXIMUM EXTENT PERMITTED BY LAW, D-LINK IS NOT LIABLE UNDER ANY CONTRACT, NEGLIGENCE, STRICT LIABILITY OR OTHER LEGAL OR EQUITABLE THEORY FOR ANY LOSS OF USE OF THE PRODUCT, INCONVENIENCE OR DAMAGES OF ANY CHARACTER, WHETHER DIRECT, SPECIAL, INCIDENTAL OR CONSEQUENTIAL (INCLUDING, BUT NOT LIMITED TO, DAMAGES FOR LOSS OF GOODWILL, LOSS OF REVENUE OR PROFIT, WORK STOPPAGE, COMPUTER FAILURE OR MALFUNCTION, FAILURE OF OTHER EQUIPMENT OR COMPUTER PROGRAMS TO WHICH D-LINK'S PRODUCT IS CONNECTED WITH, LOSS OF INFORMATION OR DATA CONTAINED IN, STORED ON, OR INTEGRATED WITH ANY PRODUCT RETURNED TO D-LINK FOR WARRANTY SERVICE) RESULTING FROM THE USE OF THE PRODUCT, RELATING TO WARRANTY SERVICE, OR ARISING OUT OF ANY BREACH OF THIS LIMITED WARRANTY, EVEN IF D-LINK HAS BEEN ADVISED OF THE POSSIBILITY OF SUCH DAMAGES. THE SOLE REMEDY FOR A BREACH OF THE FOREGOING LIMITED WARRANTY IS REPAIR, REPLACEMENT OR REFUND OF THE DEFECTIVE OR NON-CONFORMING PRODUCT. THE MAXIMUM LIABILITY OF D-LINK UNDER THIS WARRANTY IS LIMITED TO THE PURCHASE PRICE OF THE PRODUCT COVERED BY THE WARRANTY. THE FOREGOING EXPRESS WRITTEN WARRANTIES AND REMEDIES ARE EXCLUSIVE AND ARE IN LIEU OF ANY OTHER WARRANTIES OR REMEDIES, EXPRESS, IMPLIED OR STATUTORY.

**Governing Law:** This Limited Warranty shall be governed by the laws of the state of California. Some states do not allow exclusion or limitation of incidental or consequential damages, or limitations on how long an implied warranty lasts, so the foregoing limitations and exclusions may not apply. This limited warranty provides specific legal rights and the product owner may also have other rights which vary from state to state.

Notice of IEEE802.11a 5Ghz radio usage in the European Community

- At the time of writing this addendum, some countries such as Italy, Greece, Portugal and Spain hasn't allowed operation of radio devices in the 5Ghz bands, although operation of 2.4Ghz radio devices are allowed. Please check with your local authority to confirm.
- This device is restricted to **indoor use** when operated in the European Community using channels in the 5.15-5.35 GHz band to reduce the potential for interference.

#### Usage Notes:

- To remain in conformance with European National spectrum usage regulations, frequency and channel limitations will be applied on the products according to the country where the equipment will be deployed.
- This device is restricted from functioning in **Ad-hoc mode while operating in 5Ghz**. Ad-hoc mode is direct peer-to-peer communication between two client devices without an Access Point.

## DSL-G604T Wireless ADSL Router Manual

- Access points will support DFS (Dynamic Frequency Selection) and TPC (Transmit Power Control) functionality as required when operating in 5Ghz within the EU.

Allowable 802.11a Frequencies and Channels	Countries
5.15-5.25 GHz (Channels 36, 40, 44, 48)	Liechtenstein, Hungary, Switzerland
5.15-5.25 Ghz & 5.725-5.875 Ghz (Channels 36, 40, 44, 48, 149, 153, 157, 161, 165, 169)	Austria
5.15-5.35 GHz (Channels 36, 40, 44, 48, 52, 56, 60, 64)	France, Slovak
5.15-5.35 & 5.47-5.725 GHz (Channels 36, 40, 44, 48, 52, 56, 60, 64, 100, 104, 108, 112, 116, 120, 124, 128, 132, 136, 140)	Denmark, Germany, Iceland, Finland, Netherlands, Norway, Poland, Sweden, Slovenia, Luxembourg, U.K., Ireland
5.15-5.35 Ghz & 5.725-5.875 Ghz (Channels 36, 40, 44, 48, 52, 56, 60, 64, 149, 153, 157, 161, 165, 169)	Czech Republic
IEEE 802.11b 2.4Ghz operation	Countries
2.4-2.4835 Ghz	Rest of EU Community
2.4465-2.4835 Ghz  (Channels 10,11,12,13)	France

### European Community Declaration of Conformity:

English	Hereby, <i>D-Link Corporation</i> declares that this Wireless LAN device is in compliance with the essential requirements and other relevant provisions of Directive 1999/5/EC.
Finnish	<i>Valmistaja D-Link Corporation</i> vakuuttaa täten että Wireless LAN device tyyppinen laite on direktiivin 1999/5/EY oleellisten vaatimusten ja sitä koskevien direktiivin muiden ehtojen mukainen.
Dutch	Hierbij verklaart <i>D-Link Corporation</i> dat het toestel Wireless LAN device in overeenstemming is met de essentiële eisen en de andere relevante bepalingen van richtlijn 1999/5/EG  Bij deze verklaart <i>D-Link Corporation</i> dat deze Wireless LAN device voldoet aan de essentiële eisen en aan de overige relevante bepalingen van Richtlijn 1999/5/EC.
French	Par la présente <i>D-Link Corporation</i> déclare que l'appareil Wireless LAN device est conforme aux exigences essentielles et aux autres dispositions pertinentes de la directive 1999/5/CE  Par la présente, <i>D-Link Corporation</i> déclare que ce Wireless LAN device est conforme aux exigences essentielles et aux autres dispositions de la directive 1999/5/CE qui lui sont applicables
Swedish	Härmed intygar <i>D-Link Corporation</i> att denna Wireless LAN device står i överensstämmelse med de väsentliga egenskapskrav och övriga relevanta bestämmelser som framgår av direktiv 1999/5/EG.
Danish	Undertegnede <i>D-Link Corporation</i> erklærer herved, at følgende udstyr Wireless LAN device overholder de væsentlige krav og øvrige relevante krav i direktiv 1999/5/EF
German	Hiermit erklärt <i>D-Link Corporation</i> dass sich <i>dieser/diese/dieses</i> Wireless LAN device in Übereinstimmung mit den grundlegenden Anforderungen und den anderen relevanten Vorschriften der Richtlinie 1999/5/EG befindet". (BMW)  Hiermit erklärt <i>D-Link Corporation</i> die Übereinstimmung des Gerätes Wireless LAN device mit den grundlegenden Anforderungen und den anderen relevanten Festlegungen der Richtlinie 1999/5/EG. (Wien)
Greek	<i>ΜΕ ΤΗΝ ΠΑΡΟΥΣΑ</i> - <i>D-Link Corporation</i> <i>ΔΗΛΩΝΕΙ ΟΤΙ</i> Wireless LAN device <i>ΣΥΜΜΟΡΦΩΝΕΤΑΙ ΠΡΟΣ ΤΙΣ ΟΥΣΙΩΔΕΙΣ ΑΠΑΙΤΗΣΕΙΣ ΚΑΙ ΤΙΣ ΛΟΙΠΕΣ ΣΧΕΤΙΚΕΣ ΔΙΑΤΑΞΕΙΣ ΤΗΣ ΟΔΗΓΙΑΣ 1999/5/ΕΚ</i>
Italian	Con la presente <i>D-Link Corporation</i> dichiara che questo Wireless LAN device è conforme ai requisiti essenziali ed alle altre disposizioni pertinenti stabilite dalla direttiva 1999/5/CE.
Spanish	Por medio de la presente <i>D-Link Corporation</i> declara que el Wireless LAN device cumple con los requisitos esenciales y cualesquiera otras disposiciones aplicables o exigibles de la Directiva 1999/5/CE
Portuguese	<i>D-Link Corporation</i> declara que este Wireless LAN device está conforme com os requisitos essenciais e outras disposições da Directiva 1999/5/CE.

## AVERTISSEMENT AUX UTILISATEURS

L'utilisation des bandes de fréquences des 2.4GHz et 5GHz pour les RLAN est réglementée par l'ART (Autorité de Régulation des Télécoms).

**BANDE DE FREQUENCES DES 2.4GHZ**

**La décision N° 02-1008 en date du 31 octobre 2002 autorise l'utilisation d'une partie de la bande de fréquences 2400-2483,5 MHz pour les réseaux locaux radioélectriques (RLAN) comme suit :**

L'utilisation de la bande 2400-2446,5 MHz est autorisée à l'intérieur des bâtiments avec une puissance isotrope rayonnée équivalente (PIRE) limitée à 10 mW et que l'utilisation de la bande 2446,5-2483,5 MHz est autorisée à l'intérieur des bâtiments avec une PIRE limitée à 100 mW. L'utilisation en extérieur est soumise à demande d'autorisation sur la bande de fréquences de 2446,5-2483,5 MHz avec une puissance limitée à 100mW.

Dans certains départements, dont la liste est publiée par l'Autorité de régulation des télécommunications, l'utilisation de la totalité de la bande 2400- 2483,5 MHz est autorisée à l'intérieur des bâtiments avec une puissance isotrope rayonnée équivalente maximale de 100 mW.

Dans ces mêmes départements, l'utilisation de la bande 2400-2454 MHz est autorisée à l'extérieur des bâtiments avec une puissance isotrope rayonnée équivalente maximale de 100 mW et l'utilisation de la bande 2454-2483,5 MHz est autorisée à l'extérieur des bâtiments avec une puissance isotrope rayonnée équivalente maximale de 10 mW.

L'Autorité poursuit les négociations avec le ministère de la Défense en vue de l'ouverture de la totalité de la bande 2400-2483,5 MHz en intérieur et en extérieur avec une PIRE de 100 mW. Cette ouverture est acquise d'ores et déjà dans certains départements d'Outre-mer.

En installant et utilisant les produits réseaux sans fils de la gamme proposée par D-Link, vous vous engagez donc à respecter cette réglementation.

**Pour tout information complémentaire et les dernières informations concernant l'évolution de la réglementation française, nous vous conseillons de consulter le site de l'ART : [www.art-telecom.fr](http://www.art-telecom.fr).**

## **BANDE DE FREQUENCES DES 5GHZ**

L'Autorité de Régulation des Télécommunications (ART) autorise l'utilisation d'une partie de la bande de fréquences des 5GHz pour les réseaux locaux radioélectriques (RLAN) intégrant des solutions 802.11a supportant les fonctions DFS (Dynamic Frequency Selection) et TPC (Transmit Power Control).

Seule la bande 5150-5350MHz est autorisée en France pour une utilisation intérieure avec une puissance limitée à 200 mW en mode infrastructure.

En installant et en utilisant les produits réseaux sans fil 802.11a de la gamme D-Link commercialisée en France, vous vous engagez à respecter cette réglementation.

**Pour tout information complémentaire et les dernières informations concernant l'évolution de la réglementation française, nous vous conseillons de consulter le site de l'ART : [www.art-telecom.fr](http://www.art-telecom.fr).**

## **AVVERTIMENTI PER GLI UTILIZZATORI**

L'utilizzo della banda di frequenza dei 2.4 GHz per applicazioni di tipo Radio LAN sul mercato Italiano, è regolamentato dal Ministero delle Comunicazioni secondo il Nuovo Piano Nazionale Gestioni Frequenze relativo al D.M. dell'8 Luglio 2002 e dalle relative modifiche come dal Decreto del Ministero delle Comunicazioni del 20 Febbraio 2003 (nota 158).

Viene definito come Radio Local Area Network (di seguito denominate "Radio LAN" o "R-LAN") un sistema di comunicazioni in rete locale mediante radiofrequenze che utilizza apparati a corto raggio secondo le caratteristiche di armonizzazione e tecniche previste dal vigente Piano nazionale di ripartizione delle frequenze, nelle seguenti bande di frequenza: 2.400,0 – 2.483,5 MHz (brevemente banda a 2.4 GHz).

I sistemi Radio LAN sono regolati da apposite normative. Principalmente valgono le normative F.C.C. per gli U.S.A., il Canada, e gli altri paesi aderenti alle F.C.C., come gli ex paesi U.R.S.S.; mentre le norme E.T.S. 300T-328-2 e correlate, emanate dall'organo Europeo E.T.S.I., valgono per i paesi dell'Unione Europea, Giappone e per i paesi aderenti a queste normative.

La normativa tecnica ETS 300T-328-2 impone di non irradiare con una potenza E.I.R.P. superiore ai 100 mW (equivalente a 20 dBm).

In linea di principio inoltre impone agli apparati Radio LAN, di non trasmettere con una potenza elettrica effettiva superiore ai 50 mW (equivalente a 17 dBm); questo perché l'antenna a dipolo più semplice, che di solito li accompagna, ha generalmente un guadagno in trasmissione pari a circa 2.5 dBi, che fa sì che la potenza E.I.R.P. trasmessa salga a circa 80 mW (per la precisione 19.2 dBm).

Per questo motivo su tutto il territorio dell'Unione Europea, ed anche in Italia, è assolutamente vietato utilizzare antenne che abbiano un guadagno in trasmissione elevato (in linea di massima diciamo superiore ai 5 dBi), tale da portare la potenza trasmessa E.I.R.P. oltre i 100 mW (equivalente a 20 dBm).

Nel caso in cui invece sia possibile regolare il livello di potenza trasmessa dagli Access Point, viene data la possibilità di utilizzare antenne ad alto guadagno attenendosi strettamente ad una serie di istruzioni di seguito riportate che consentono questo utilizzo rimanendo comunque all'interno della potenza massima trasmessa E.I.R.P. pari e non superiore a 100mW (20dBm).

## **CALCOLO DELLA POTENZA E.I.R.P. IN EMISSIONE**

La formula di calcolo per ottenere l'E.I.R.P. effettivo è la seguente:

$$E.I.R.P. (dBm) = Ptx (dBm) + Gtx (dBi) \text{ dove}$$

**Ptx** = Potenza trasmessa al connettore dell'antenna di trasmissione

**Gtx** = Guadagno dell'antenna di trasmissione

Il valore ottenuto dalla somma, NON deve superare quanto espresso dalla normativa ovvero 20dBm. Nel caso in cui si voglia convertire il risultato ottenuto in mW, utilizzare la semplice tabella di conversione di seguito riportata.

(dBm)	mW	(dBm)	mW	(dBm)	mW
0	1	11	12.5	21	128
1	1.25	12	16	22	160
2	1.56	13	20	23	200
3	2	14	25	24	256
4	2.5	15	32	25	320
5	3.12	16	40	26	400
6	4	17	50	27	512
7	5	18	64	28	640
8	6.25	19	80	29	800
9	8	20	100	30	1 watt
10	10				

**INSTALLAZIONE**

**SO PRIVATO**

Come riportato nel D.P.R. n° 447/01 Art. 6 – Punto B (Libero uso) del 5 Ottobre 2001:

“Sono di libero uso le apparecchiature che impiegano frequenze di tipo collettivo, senza alcuna protezione, per collegamenti a brevissima distanza con apparati a corto raggio, compresi quelli rispondenti alla raccomandazione CEPT-ERC/REC 70-03, tra le quali rientrano in particolare:

- b) Reti locali di tipo radiolan e hiperlan nell’ambito del fondo, ai sensi dell’articolo 183, comma secondo, del decreto del Presidente della Repubblica n. 156 del 1973; sono disciplinate ai sensi dell’articolo 5 le reti hiperlan operanti obbligatoriamente in ambienti chiusi o con vincoli specifici

...

Per “fondo” pubblico o privato, si intende un ambiente sia interno che esterno ben circoscritto e delimitato.

Per “fondo privato” possiamo, per esempio, fare riferimento a uffici, capannoni industriali, abitazioni, aree all’aperto private che non attraversano il suolo pubblico o il passaggio di pubblico dominio/demanio.

Per “fondo pubblico” possiamo, per esempio, fare riferimento a tutti quei luoghi appartenenti allo Stato o alle amministrazioni centrali e locali quali strade, autostrade, strade ferrate, spiagge, porti, fiumi etc.

E’ comunque necessario fare 2 specifiche distinzioni:

**Utilizzo di sistemi Radio LAN ad uso privato con installazioni indoor o outdoor su fondo/soilo privato:**

E’ possibile utilizzare liberamente sistemi Radio LAN purché vengano rispettate le normative vigenti soprattutto per quanto riguarda l’emissione massima in potenza come sopra riportato.

**Utilizzo di sistemi Radio LAN ad uso privato con installazioni outdoor con attraversamento di fondo/soilo pubblico:**

Come specificato nel D.P.R. n° 447/01 Art. 5 – Punto 2.2 del 5 Ottobre 2001, è necessario richiedere un’autorizzazione generale al “Ministero delle Comunicazioni Direzione generale per le concessioni e le autorizzazioni” per l’installazione di sistemi Radio LAN ad uso privato con installazioni outdoor con attraversamento di suolo pubblico.

Per richiedere l’autorizzazione generale, fare riferimento all’allegato C presente all’interno del D.P.R. n° 447/01 in qualità di canovaccio per la stesura della richiesta.

Per ulteriori informazioni e delucidazioni, fare riferimento al D.P.R. n° 447/01 del 5 Ottobre 2001.

## **INSTALLAZIONE ED UTILIZZO DI SISTEMI RADIO LAN AD USO PUBBLICO**

A fronte dell’ultimo decreto relativo all’accesso ad Internet senza fili in regime di autorizzazione generale e uso pubblico rilasciato dal Ministero delle Comunicazioni in data 28 Maggio 2003, sono stati rivisti i parametri relativi all’installazione ed all’utilizzo dei sistemi Radio LAN ad uso pubblico.

Per completezza di informazioni, suggeriamo di fare riferimento al decreto in questione disponibile sul sito del Ministero delle Comunicazioni al link <http://www.comunicazioni.it/it/index.php?IdNews=39>

### **ACCESSO ALLE FONTI DI INFORMAZIONE**

Per tutte le informazioni complementari, a supporto di questa informativa e concernenti all’evoluzione della normativa wireless sul territorio italiano, vi preghiamo di fare riferimento al sito Internet del Ministero delle Comunicazioni <http://www.comunicazioni.it>



# TABLE OF CONTENTS

About This User's Guide.....	11
Before You Start.....	11
Installation Requirements.....	11
<b>INTRODUCTION.....</b>	<b>13</b>
Router Description and Operation.....	13
Front Panel.....	16
Rear Panel .....	17
Wireless LAN Basics.....	17
About 802.11g Wireless.....	18
<b>HARDWARE INSTALLATION.....</b>	<b>20</b>
Location.....	20
Network Connection .....	20
Choosing the Best Location for Wireless Operation.....	22
Power On Router.....	23
Factory Reset Button.....	23
<b>CONFIGURING THE ROUTER FOR THE FIRST TIME.....</b>	<b>24</b>
Configuring IP Settings on Your Computer.....	24
Configure IP Settings.....	25
<b>ACCESSING THE CONFIGURATION MANAGER.....</b>	<b>27</b>
Configure the Router with the Configuration Wizard.....	28
<b>HOME.....</b>	<b>46</b>
Wireless.....	46
WAN Configuration.....	47
LAN Configuration.....	56
DHCP.....	57
DNS.....	59
Dynamic DNS.....	60
<b>ADVANCED CONFIGURATION.....</b>	<b>62</b>
UPnP.....	62
Virtual Server.....	64
LAN Clients.....	65
SNMP .....	68
Filters.....	70
Bridge Filters.....	72
Routing .....	74
DMZ.....	76
Firewall.....	78
RIP.....	81
PPP.....	83
ADSL.....	85
ATM VCC.....	86
Wireless Management.....	88
Wireless Performance.....	91
<b>TOOLS.....</b>	<b>93</b>
Admin.....	93
Time.....	94

Remote Log.....	95
System.....	97
Firmware.....	98
Miscellaneous.....	99
Test.....	100
<b>STATUS.....</b>	<b>102</b>
Device Info.....	102
DHCP Clients.....	103
Log.....	104
Statistics.....	106
ADSL .....	107
<b>HELP.....</b>	<b>109</b>
<b>TECHNICAL SPECIFICATIONS.....</b>	<b>110</b>
<b>IP ADDRESS SETUP.....</b>	<b>112</b>
<b>IP CONCEPTS.....</b>	<b>115</b>
<b>MICROFILTERS AND SPLITTERS.....</b>	<b>119</b>

## About This User's Guide

This manual provides instructions on how to install the DSL-G604T ADSL Router and use it to connect a computer or Ethernet LAN to the Internet.

## Before You Start

Please read and make sure you understand all the prerequisites for proper installation of your new Router. Have all the necessary information and equipment on hand before beginning the installation.

## Installation Overview

The procedure to install the Router can be described in general terms in the following steps:

1. Gather information and equipment needed to install the device. Before you begin the actual installation make sure you have all the necessary information and equipment.
2. Install the hardware, that is, connect the cables (Ethernet and telephone) to the device and connect the power adapter.
3. Check the IP settings on your computer and change them if necessary so the computer can access the web-based software built into the Router.
4. Use the web-based management software to configure the device to suit the requirements of your ADSL account.

## Installation Requirements

**Information you will need from your ADSL service provider:**

<b>Username</b>	This is the Username that is used to log on to your ADSL service provider's network. It is commonly in the form – <b>user@isp.com</b> .	Record your info here.
<b>Password</b>	This is the Password that is used, in conjunction with the Username above, to log on to your ADSL service provider's network.	
<b>Connection Protocol</b>	This is the method that your ADSL service provider uses to send and receive data between the Internet and your computer.	
<b>VPI</b>	This is the Virtual Path Identifier ( <b>VPI</b> ). It is used in conjunction with the Virtual Channel Identifier (VCI) below, to identify the data path between your ADSL service provider's network and your computer.	
<b>VCI</b>	This is the Virtual Channel Identifier ( <b>VCI</b> ). It is used in conjunction with the VPI above to identify the data path between your ADSL service provider's network and your computer.	

**Information you will need about your DSL-G604T ADSL Router:**

<b>Username</b>	This is the Username you will be prompted to enter when you access the DSL-G604T's configuration screens using a Web browser. The default Username is <b>admin</b> .	Record your info here.
<b>Password</b>	This is the Password you will be prompted to enter when you access the DSL-G604T's configuration screens using a Web browser. The default Password is <b>admin</b> .	
<b>LAN IP address for the DSL-G604T</b>	This is the IP address you will enter into the <b>Address</b> field of your Web browser to access the DSL-G604T's configuration screens using a Web Browser. The default IP address is <b>192.168.1.1</b> .	
<b>LAN Subnet Mask for the DSL-G604T</b>	This is the subnet mask used by the DSL-G604T, and will be used throughout your LAN. The default subnet mask is <b>255.255.255.0</b> .	

**Information you will need about your LAN or computer:**

<b>Ethernet NIC</b>	If your computer has an Ethernet NIC, you can connect the DSL-G604T to this Ethernet port using an Ethernet cable. You can also use the Ethernet port on the DSL-G604T to connect to other Ethernet devices, such as a Wireless Access Point.	Record your info here.
<b>DHCP Client status</b>	Your DSL-G604T ADSL Router is configured, by default, to be a DHCP server. This means that it can assign an IP address, subnet mask, and a default gateway address to computers on your LAN. The range of IP addresses the DSL-G604T will assign are from <b>192.168.1.2</b> to <b>192.168.1.254</b> . Your computer (or computers) needs to be configured to <b>Obtain an IP address automatically</b> (that is, they need to be configured as DHCP clients.)	

It is recommended that you collect and record this information here, or in some other secure place, in case you have to re-configure your ADSL connection in the future. Once you have the above information, you are ready to setup and configure your DSL-G604T ADSL Router.

## Introduction

This section provides a brief description of the Router, its associated technologies and a list of Router features.

### What is ADSL?

Asymmetric Digital Subscriber Line (ADSL) is an access technology that utilizes ordinary copper telephone lines to enable broadband high-speed digital data transmission and interactive multimedia applications for business and residential customers. For ADSL services, it is not necessary to install expensive new cabling or condition the line in any way.

ADSL greatly increases the signal carrying capacity of copper telephone lines without interfering with regular telephone services. For the ADSL user, this means faster downloads and more reliable connectivity. ADSL devices make it possible to enjoy benefits such as high-speed Internet access without experiencing any loss of quality or disruption of voice/fax telephone capabilities.

ADSL provides a dedicated service over a single telephone line operating at speeds of up to 8 Mbps downstream and up to 640 Kbps upstream, depending on local telephone line conditions. A secure point-to-point connection is established between the user and the central office of the service provider. D-Link ADSL devices incorporate the recommendations of the ADSL Forum regarding framing, data format, and upper layer protocols.

### Router Description and Operation

The DSL-G604T ADSL Router is designed to provide a simple, cost-effective and secure ADSL Internet connection for your small- to medium-sized private network. The DSL-G604T combines the benefits of high-speed ADSL connection technology and TCP/IP routing with a conventional Ethernet interface in one compact and convenient package. ADSL connection technology enables many interactive multi-media applications such as video conferencing and collaborative computing.

The Router is easy to install and use. The DSL-G604T connects to an Ethernet LAN via a standard Ethernet 10BASE-T interface using RJ-45 connectors. The ADSL connection is made using ordinary twisted-pair telephone line with standard RJ-11 connectors. This arrangement means that several PCs can be networked and connected to the Internet using a single WAN interface and IP address.

### Low Pass Filters

Since ADSL and telephone services share the same copper wiring to carry their respective signals, a filtering mechanism may be necessary to avoid mutual interference. A low pass filter device can be installed for each telephone that shares the line with the ADSL line. These filters are easy to install passive devices that connect to the ADSL device and/or telephone using standard telephone cable. Ask your service provider for more information about the use of low pass filters with your installation. Appendix B provides illustrated examples of how to install two common styles of low pass filters.

### Operating Systems

The DSL-G604T uses an HTML-based web interface for setup and management. The web configuration manager may be accessed using any operating system capable of running web browser software, including Windows 98 SE, Windows ME, Windows 2000, and Windows XP.

## Web Browser

Any common web browser can be used to configure the Router using the web configuration management software. The program is designed to work best with more recently released browsers such as Mozilla, Firefox, Opera, Microsoft Internet Explorer® version 5.0, Netscape Navigator® version 4.7, or later versions. The web browser must have JavaScript enabled. JavaScript is enabled by default on many browsers. Make sure JavaScript has not been disabled by other software (such as virus protection or web user security packages) that may be running on your computer.

## Ethernet Port (NIC Adapter)

Any computer that uses the Router must be able to connect to it through the Ethernet port on the Router. This connection is an Ethernet connection and therefore requires that your computer be equipped with an Ethernet port as well. Most notebook computers are now sold with an Ethernet port already installed. Likewise, most fully assembled desktop computers come with an Ethernet NIC adapter as standard equipment. If your computer does not have an Ethernet port, you must install an Ethernet NIC adapter before you can use the Router. If you must install an adapter, follow the installation instructions that come with the Ethernet NIC adapter.

## Additional Software

It may be necessary to install software on your computer that enables the computer to access the Internet. Additional software must be installed if you are using what is called a “bridged” connection. For a bridged connection, the information needed to make and maintain the Internet connection is stored on your computer, not in the Router. This type of connection is similar to the arrangement used for analog dial-up modems, but the connection speed is much faster. Various terms are used to describe a bridged ADSL connection including the term “RFC 1483 Bridge” which is used in this guide.

## About Bridged Ethernet Connections (RFC 1483)

Using this method, the DSL-G604T acts as a transparent bridge, and is invisible to other devices on both the WAN and LAN side of the bridge. It is therefore necessary to provide some means of acquiring global IP settings for your account.

All connections to the Internet require a unique global IP address. For bridged connections, the global IP settings must reside in a TCP/IP enabled device on the LAN side of the bridge, such as a PC, server or firewall hardware. The IP address can be assigned in a number of ways. Your network service provider will give you instructions about any additional connection software or NIC configuration that may be required.

## Account Information (User Name and Password)

Most users will need to supply a user name and password used to access the service provider’s network (and ultimately, the Internet). This information is stored either in the Router’s memory or on your computer depending on the type of ADSL connection you have.

ACCOUNT INFORMATION (PPP Connections Only)
User Name:
Password:

## Router Features

The D-Link DSL-G604T ADSL Router provides the following features:

- Data rates up to 24 Mbps for downstream and 1Mbps for upstream
- Friendly web-based graphical user interface for configuration and management
- Supports up to eight simultaneous virtual connections for a single ADSL account

- Supports T1.413 issue 2, G.dmt and G.lite for the ADSL standard
- Supports G.dmt.bis and G.lite.bis for the ADSL2 standard
- Supports g.992.5 for the ADSL standard
- Auto-handshake and rate adaptation for different ADSL flavors
- Widest range of DSLAM interoperability
- Built-in MIBs for SNMP management
- Upgradeable firmware through HTTP

### **Packing List**

Open the shipping carton and carefully remove all items. In addition to this User's Guide, ascertain that you have:

- One DSL-G604T ADSL Router
- One twisted-pair telephone cable used for ADSL connection
- One CAT-5 Ethernet cable
- One AC power adapter suitable for your electric service
- This Manual on CD ROM
- One Quick Installation Guide

## Front Panel

Place the Router in a location that permits an easy view of the LED indicators on the front panel. The LED indicators on the front panel include the **Power**, **Status**, **ADSL Link/Act**, **WLAN Link/Act**, and **Ethernet Link/Act** indicators.



<b>Power</b>	Steady green light indicates the unit is powered on. When the device is powered off this remains dark.
<b>Status</b>	Lights steady green during power on self-test (POST). Once the connection status has been settled, the light will blink green. If the indicator lights steady green after the POST, the system has failed and the device should be rebooted.
<b>ADSL (Link/Act)</b>	Steady green light indicates a valid ADSL connection. This will light after the ADSL negotiation process has been settled. A blinking green light indicates activity on the WAN (ADSL) interface.
<b>WLAN (Link/Act)</b>	Steady green light indicates a wireless connection. A blinking green light indicates activity on the WLAN interface.
<b>Ethernet (Link/Act) 1 - 4</b>	A solid green light indicates a valid link on startup. This light will blink when there is activity currently passing through the Ethernet ports.



## Rear Panel

Connect the AC power adapter cord and network cables on the rear panel. The power switch and reset button are also located on the back of the device. Connect the antennas to the antenna posts.

All cable connections to the Router are made at the rear panel. The power switch and factory reset button is located here as well.

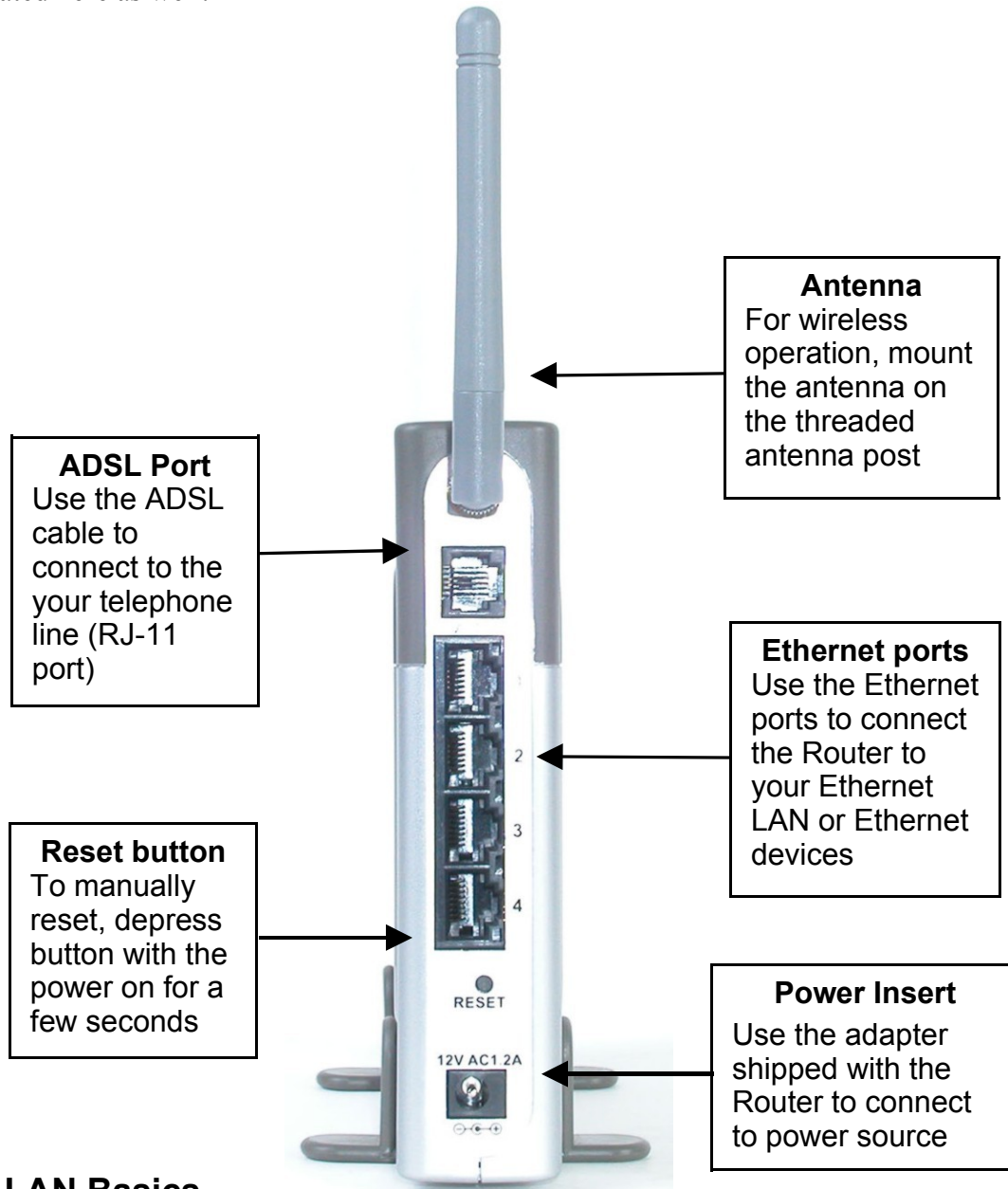

## Wireless LAN Basics

Some basic understanding of 802.11g wireless technology and terminology is useful when you are setting up the Router or any wireless access point. If you are not familiar with wireless networks please take a few minutes to learn the basics.

### Radio Transmission

Wireless LAN or WLAN devices use electromagnetic waves within a broad, unlicensed range of the radio spectrum to transmit and receive radio signals. When a wireless access point is present, it becomes a base station for the WLAN nodes in its broadcast range. WLAN nodes transmit digital data

using FM (frequency modulation) radio signals. WLAN devices generate a carrier wave and modulate this signal using various techniques. Digital data is superimposed onto the carrier signal. This radio signal carries data to WLAN devices within range of the transmitting device. The antennae of WLAN devices listen for and receive the signal. The signal is demodulated and the transmitted data extracted. The transmission method used by the access point is called Direct Sequence Spread Spectrum (DSSS) and operates in a range of the radio spectrum between 2.4GHz and 2.5GHz for transmission. See the technical specifications for more details on wireless operation.

## **Range**

Range should not be a problem in most homes or small offices. If you experience low or no signal strength in some areas, consider positioning the Router in a location between the WLAN devices that maintains a roughly equal straight-line distance to all devices that need to access the Router through the wireless interface. Adding more 802.11g access points to rooms where the signal is weak can improve signal strength. Read the section about placement of the Router titled Location in the next chapter, Hardware Installation, for more information.

## **SSID**

Wireless networks use an SSID (Service Set Identifier) to allow wireless devices to roam within the range of the network. Wireless devices that wish to communicate with each other must use the same SSID. Several access points can be set up using the same SSID so that wireless stations can move from one location to another without losing connection to the wireless network. The DSL-G604T operates in *Infrastructure* mode. It controls network access on the wireless interface in its broadcast area. It will allow access to the wireless network to devices using the correct SSID after a negotiation process takes place. By default the DSL-G604T broadcasts its SSID so that any wireless station in range can learn the SSID and ask permission to associate with it. Many wireless adapters are able to survey or scan the wireless environment for access points. An access point in Infrastructure mode allows wireless devices to survey that network and select an access point with which to associate. You may disable SSID broadcasting in the web manager's wireless menu.

## **Wireless Security**

Various security options are available on the DSL-G604T including open or WEP, WPA, and WPA-PSK. Authentication may use an open system or a shared key. For details on these methods and how to use them, please read the wireless LAN configuration information in chapters 3 (Basic Router Configuration) and 4 (Advanced Router Configuration) below.

## **About 802.11g Wireless**

Today's 11-megabits-per-second 802.11b wireless networks are fine for broadband Internet access (which typically tops out at about 1 mbps) but rather slow for large internal file transfers or streaming video. However, 54-mbps, corporate-oriented 802.11a is expensive--and because its radio uses the 5-GHz band and 802.11b uses the 2.4-GHz band, upgrading to an 802.11a network means either scrapping 802.11b gear or buying even-pricier hardware that can support both standards. But 802.11g promises the same speed as 802.11a and the ability to coexist with 802.11b equipment on one network, since it too uses the 2.4-GHz band. 802.11g is an extension to 802.11b, the basis of many wireless LANs in existence today. 802.11g will broaden 802.11b's data rates to 54 Mbps within the 2.4 GHz band using OFDM (orthogonal frequency division multiplexing) technology. Because of backward compatibility, an 802.11b radio card will interface directly with an 802.11g access point (and vice versa) at 11 Mbps or lower depending on range. You should be able to upgrade the newer 802.11b access points to be 802.11g compliant via relatively easy firmware upgrades.

Similar to 802.11b, 802.11g operates in the 2.4GHz band, and the transmitted signal uses approximately 30MHz, which is one third of the band. This limits the number of non-overlapping 802.11g access points to three, which is the same as 802.11b.

## Hardware Installation

The DSL-G604T functions on two separate networks, as an Ethernet LAN and as an ADSL WAN. When deciding where to put the Router, the user must take into account the fact that it is connected to these three networks with three types of media. Ethernet cables connect the Router to computers and network devices, and the ADSL line connects it to a wall socket. In addition, the device must be near an AC outlet for power. How to accommodate these wired connections is often not a complicated matter, however, the added dimension of wireless communication does complicate the decision of Router placement.

### Location

The Router can be placed on a shelf or desktop and ideally you should be able to see the LED indicators on the front if you need to view them for troubleshooting.

### Network Connection

Complete the connection to the network through the ADSL port and the Ethernet port on the back of the Router.

#### Connect ADSL Line

Use the ADSL cable included with the Router to connect it to a telephone wall socket. Plug one end of the cable into the ADSL port (RJ-11 receptacle) on the rear panel of the Router and insert the other end into the RJ-11 wall socket. If you are using a low pass filter device, follow the instructions included with the device or given to you by your service provider. The ADSL connection represents the WAN interface. It is the physical link to the ISP's network backbone and ultimately to the Internet.

#### Connect Router to Ethernet

The Router may be connected to any 10/100BASE-TX Ethernet LAN. Any connection to an Ethernet concentrating device such as a switch or hub must operate at a speed of 10/100 Mbps only. When connecting the Router to any Ethernet device that is capable of operating at speeds higher than 10Mbps, be sure that the device has auto-negotiation (NWay) enabled for the connecting port. Use standard twisted-pair cable with RJ-45 connectors. The RJ-45 port on the Router is a crossed port (MDI-X). Follow standard Ethernet guidelines when deciding what type of cable to use to make this connection. When connecting the Router directly to a PC or server use a normal straight-through cable. You should use a crossed cable when connecting the Router to a normal (MDI-X) port on a switch or hub. Use a normal straight-through cable when connecting it to an uplink (MDI-II) port on a hub or switch.

The rules governing Ethernet cable lengths apply to the LAN to Router connection. Be sure that the cable connecting the LAN to the Router does not exceed 100 meters.

#### Hub or Switch to Router Connection

Connect the Router to an uplink port (MDI-II) on an Ethernet hub or switch with a straight-through cable as shown in the diagram below:

If you wish to reserve the uplink port on the switch or hub for another device, connect to any on the other MDI-X ports (1x, 2x, etc.) with a crossed cable.

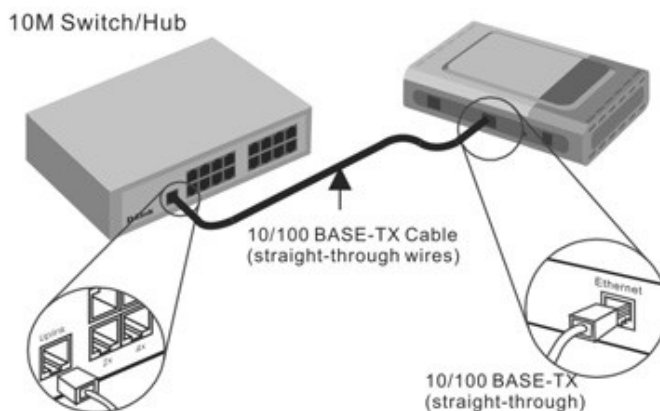

### Computer to Router Connection

You can connect the Router directly to a 10/100BASE-TX Ethernet adapter card (NIC) installed on a PC using the Ethernet cable provided as shown in this diagram.

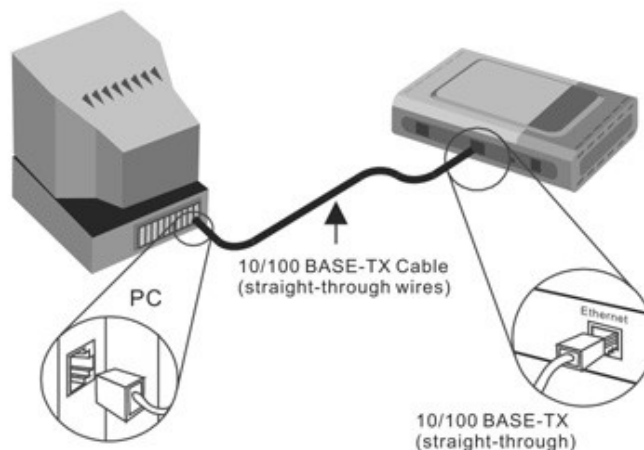
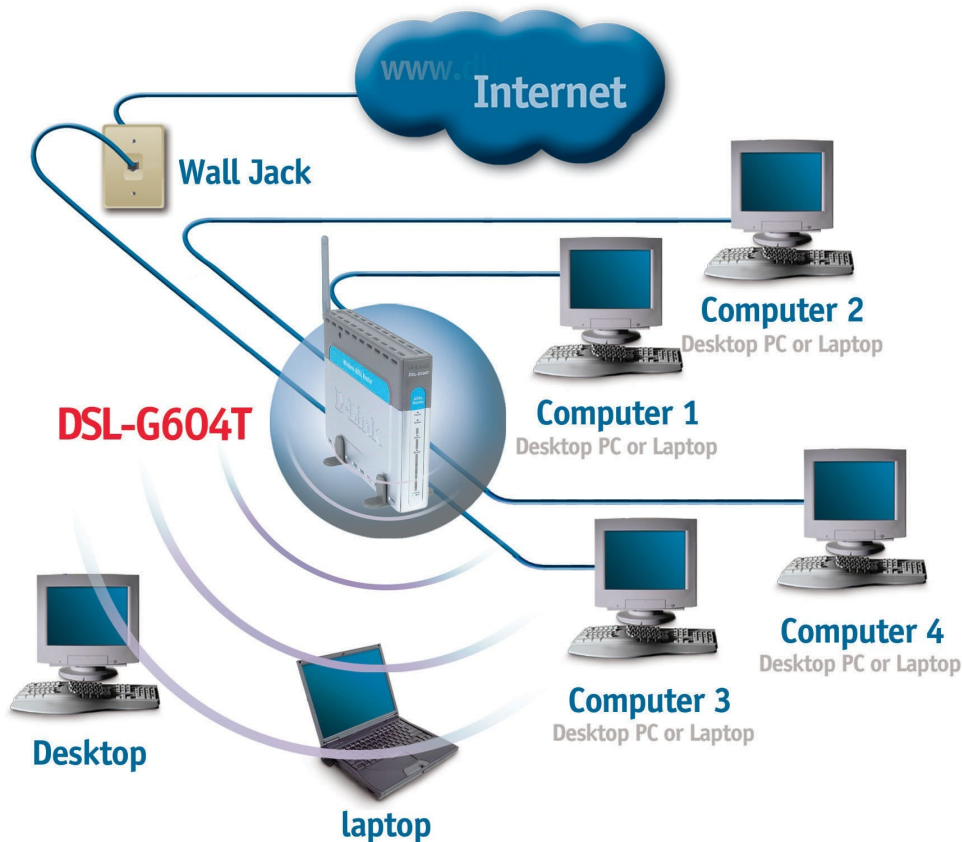

Figure 2- . Hub or Switch to Router

Figure 2- . Computer to Router Connection

The illustration below shows the DSL-G604T connected to Ethernet LAN devices, Wireless LAN devices and the Internet.



## Choosing the Best Location for Wireless Operation

Many environmental factors can affect the effective wireless function of the DSL-G604T. If this is your first time setting up a wireless network device, read and consider the points listed below.

The access point can be placed on a shelf or desktop, ideally you should be able to see the LED indicators on the front if you need to view them for troubleshooting.

Designed to go up to 100 meters indoors and up to 300 meters outdoors, Wireless LAN lets you access your network from anywhere you want. However, the number of walls, ceilings, or other objects that the wireless signals must pass through can limit signal range. Typical ranges vary depending on the types of materials and background RF noise in your home or business. For optimum range and signal strength, use these basic guidelines:

1. **Keep the number of walls and ceilings to a minimum:**  
The signal emitted from Wireless LAN devices can penetrate through ceilings and walls. However, each wall or ceiling can reduce the range of Wireless LAN devices from 1 to 30M. Position your wireless devices so that the number of walls or ceilings obstructing the signal path is minimized.
2. **Consider the direct line between access points and workstations:** A wall that is 0.5 meters thick, at a 45-degree angle appears to be almost 1 meter thick. At a 2-degree angle, it is over 14 meters thick. Be careful to position access points and client adapters so the signal can travel straight through (90° angle) a wall or ceiling for better reception.

3. **Building Materials make a difference:** Buildings constructed using metal framing or doors can reduce effective range of the device. If possible, position wireless devices so that their signal can pass through drywall or open doorways, avoid positioning them so that their signal must pass through metallic materials. Poured concrete walls are reinforced with steel while cinderblock walls generally have little or no structural steel.
4. **Position the antennas for best reception.** Play around with the antenna position to see if signal strength improves. Some adapters or access points allow the user to judge the strength of the signal.
5. **Keep your product away (at least 1-2 meters) from electrical devices:** Position wireless devices away from electrical devices that generate RF noise such as microwave ovens, monitors, electric motors, etc.

## **Power On Router**

To power on the Router:

1. Insert the AC Power Adapter cord into the power receptacle located on the rear panel of the Router and plug the adapter into a suitable nearby power source.
2. You should see the Power LED indicator light up and remain lit. The Status LED should light solid green and begin to blink after a few seconds.
3. If you have the Router connected to your network you can look at the Ethernet Link/Act LED indicators to make sure they have valid connections. The Router will attempt to establish the ADSL connection, if the ADSL line is connected and the connection is properly configured this should light up after several seconds.

## **Factory Reset Button**

The Router may be reset to the original factory default settings by depressing the reset button for a few seconds while the device is powered on. Use a ballpoint or paperclip to push down the reset button. Remember that this will wipe out any settings stored in flash memory including IP settings. The factory default IP address of the Router is 192.168.1.1 and the subnet mask is 255.255.255.0.

## Configuring the Router for the First Time

The first time you setup the Router it is recommended that you configure the WAN connection using a single computer making sure that both the computer and the Router are not connected to the LAN. Once the WAN connection is functioning properly you may continue to make changes to the Router configuration including the IP settings. This chapter is concerned with using your computer to configure the WAN connection. The following chapter describes the various menus used to configure and monitor the Router including how to change IP settings. This chapter discusses the steps to first establish the WAN connection. The remaining features, not directly concerned with establishing the initial connection, are explained in Chapter 4, *Web-based Management*.

It is recommended that you install and configure the Router using one non-networked computer. This allows you to verify that the ADSL service is functioning and that you are able to communicate with the device. Once the initial ADSL connection is established, you can proceed to build an Ethernet LAN around the device or incorporate it into an existing LAN.

### WAN Configuration Summary

1. **Connect to the Router** To configure the WAN connection used by the Router it is first necessary to communicate with the Router through its management interface, which is HTML-based and can be accessed using a web browser. To access the management software your computer must be able to “see” the Router. Your computer can see the Router if it is in the same “neighborhood” or subnet as the Router. This is accomplished by making sure your computer has IP settings that place it in the same subnet as the Router. The easiest way to make sure your computer has the correct IP settings is to configure it to use the DHCP server of the computer. The next section describes how to change the IP configuration for a computer running a Windows operating system to be a DHCP client.
2. **Configure the WAN Connection** Once you are able to access the configuration software you can proceed to change the settings required to establish the ADSL connection and connect to the service provider’s network. There are different methods used to establish the connection to the service provider’s network and ultimately to the Internet. You should know what Encapsulation and connection type you are required to use for your ADSL service. It is also possible that you must change the PVC settings used for the ADSL connection. Your service provider should provide all the information you need to configure the WAN connection.

### Configuring IP Settings on Your Computer

In order to configure your system to receive IP settings from the Router it must first have the TCP/IP protocol installed. If you have an Ethernet port on your computer, it probably already has TCP/IP protocol installed. If you are using Windows XP the TCP/IP is enabled by default for standard installations. Below is an illustrated example of how to configure a Windows XP system to automatically obtain IP settings from the Router. Following this example is a step-by-step description of the procedures used on the other Windows operating systems to first check if the TCP/IP protocol has been installed; if it is not, instructions are provided for installing it. Once the protocol has been installed you can configure the system to receive IP settings from the Router.

For computers running non-Windows operating systems, follow the instructions for your OS that configure the system to receive an IP address from the Router, that is, configure the system to be a DHCP client.



## Configure IP Settings



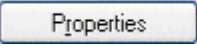
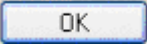

You must now enable your computer to access the Router's configuration software. To do this you will need to configure the IP settings on your computer. Follow these instructions to configure the IP settings for the operating system installed on your computer.

### Windows XP

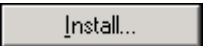

1. In the Windows task bar, click the Start button, and then click **Control Panel**.
2. Double-click the Network Connections icon.
3. In the LAN or High-Speed Internet window, right-click on icon corresponding to your network interface card (NIC) and select **Properties**. (This icon may be labeled *Local Area Connection*).
4. The Local Area Connection dialog box displays with a list of currently installed network items.
5. Make sure that the check box to the left of the item labeled Internet Protocol TCP/IP is checked, and click .
6. In the Internet Protocol (TCP/IP) Properties dialog box, click the button labeled **Use the following IP address**:
7. Type in IP settings as follows, IP address: **192.168.1.2** and Subnet mask: **255.255.255.0**.
8. Click  twice to confirm your changes, and close the Control Panel.

### Windows 2000



First, check for the IP protocol and, if necessary, install it:

1. In the Windows task bar, click the Start button, point to **Settings**, and then click **Control Panel**.
2. Double-click the Network and Dial-up Connections icon.
3. In the Network and Dial-up Connections window, right-click the Local Area Connection icon, and then select **Properties**.
4. The Local Area Connection Properties dialog box displays with a list of currently installed network components. If the list includes Internet Protocol (TCP/IP), then the protocol has already been enabled. Skip to step .
5. If Internet Protocol (TCP/IP) does not display as an installed component, click .
6. In the Select Network Component Type dialog box, select **Protocol**, and then click .
7. Select **Internet Protocol (TCP/IP)** in the Network Protocols list, and then click .
8. You may be prompted to install files from your Windows 2000 installation CD or other media. Follow the instructions to install the files.
9. If prompted, click  to restart your computer with the new settings.

Next, configure IP information:

1. In the Control Panel, double-click the Network and Dial-up Connections icon.
2. In Network and Dial-up Connections window, right-click the Local Area Connection icon, and then select **Properties**.
3. In the Local Area Connection Properties dialog box, select **Internet Protocol (TCP/IP)**, and then click .
4. In the Internet Protocol (TCP/IP) Properties dialog box, click the button labeled **Use the following IP address**:
5. Type in IP settings as follows, **IP address: 192.168.1.2** and Subnet mask: **255.255.255.0**.
6. Click  twice to confirm and save your changes, and then close the Control Panel.

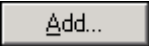

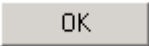
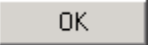
## Windows Me

1. In the Windows task bar, click the Start button, point to **Settings**, and then click **Control Panel**.
2. Double-click the Network and Dial-up Connections icon.
3. In the Network and Dial-up Connections window, right-click on the Network icon, then select **Properties**.
4. The Network Properties dialog box displays with a list of currently installed network components. If the list includes Internet Protocol (TCP/IP), then the protocol has already been enabled. Skip to step .
5. If Internet Protocol (TCP/IP) does not display as an installed component, click .
6. In the Select Network Component Type dialog box, select **Protocol**, and then click .
7. Select **Microsoft** in the Manufacturers box.
8. Select **Internet Protocol (TCP/IP)** in the Network Protocols list, and then click .
9. You may be prompted to install files from your Windows Me installation CD or other media. Follow the instructions to install the files.
10. If prompted, click  to restart your computer with the new settings.

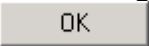
Next, configure the IP information:

1. In the Control Panel, double-click the Network and Dial-up Connections icon.
2. In Network and Dial-up Connections window, right-click the Network icon, and then select **Properties**.
3. In the Network Properties dialog box, select **TCP/IP**, and then click .
4. In the TCP/IP Settings dialog box, click the **Specify IP address** option.
5. Type in IP settings as follows, **IP address: 192.168.1.2** and **Subnet mask: 255.255.255.0**.
6. Click  twice to confirm and save your changes, and then close the Control Panel.

## Windows 95, Windows 98 and Windows 98SE

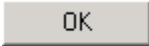
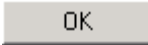
1. First, check for the IP protocol and, if necessary, install it:
2. In the Windows task bar, click the Start button, point to **Settings**, and then click **Control Panel**.
3. Double-click the Network icon.
4. The Network dialog box displays with a list of currently installed network components. If the list includes TCP/IP, and then the protocol has already been enabled. Skip to step .
5. If TCP/IP does not display as an installed component, click .
6. The Select Network Component Type dialog box displays.
7. Select **Protocol**, and then click .
8. The Select Network Protocol dialog box displays.
9. Click on **Microsoft** in the Manufacturers list box, and then click **TCP/IP** in the Network Protocols list box.
10. Click  to return to the Network dialog box, and then click  again.
11. You may be prompted to install files from your Windows 95/98 installation CD. Follow the instructions to install the files.
12. Click  to restart the PC and complete the TCP/IP installation.

Next, configure the IP information:

1. Open the Control Panel window, and then click the Network icon.
2. Select the network component labeled TCP/IP, and then click .
3. If you have multiple TCP/IP listings, select the listing associated with your network card or adapter.
4. In the TCP/IP Properties dialog box, click the IP Address tab.

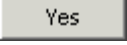
5. Click the **Specify an IP address** option.
6. Type in IP settings as follows, **IP address: 192.168.1.2** and Subnet mask: **255.255.255.0**.
7. Click  twice to confirm and save your changes.
8. You will be prompted to restart Windows.
9. Click .

#### Windows NT 4.0

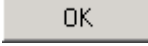
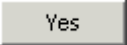
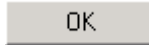
1. First, check for the IP protocol and, if necessary, install it:
2. In the Windows NT task bar, click the Start button, point to **Settings**, and then click **Control Panel**.
3. In the Control Panel window, double click the Network icon.
4. In the Network dialog box, click the Protocols tab.
5. The Protocols tab displays a list of currently installed network protocols. If the list includes TCP/IP, then the protocol has already been enabled. Skip to step .
6. If TCP/IP does not display as an installed component, click .
7. In the Select Network Protocol dialog box, select **TCP/IP**, and then click .
8. You may be prompted to install files from your Windows NT installation CD or other media. Follow the instructions to install the files.
9. After all files are installed, a window displays to inform you that a TCP/IP service called DHCP can be set up to dynamically assign IP information.
10. Click  to continue, and then click  if prompted to restart your computer.

Next, configure the IP information:

1. Open the Control Panel window, and then double-click the Network icon.
2. In the Network dialog box, click the Protocols tab.
3. In the Protocols tab, select **TCP/IP**, and then click .
4. In the Microsoft TCP/IP Properties dialog box, click the **Specify an IP address** option.
5. Type in IP settings as follows, **IP address: 192.168.1.2** and Subnet mask: **255.255.255.0**.

Click  twice to confirm and save your changes, and then close the Control Panel.

## Accessing the Configuration Manager

Now that your computer's IP settings allow it to communicate with the Router, you can access the configuration software.

**Note:** Be sure that the web browser on your computer is not configured to use a proxy server in the Internet settings. In Windows Internet Explorer, you can check if a proxy server is enabled using the following procedure:

1. In Windows, click on the **Start** button, go to **Settings** and choose **Control Panel**.
2. In the **Control Panel** window, double-click on the **Internet Options** icon.
3. Click the **Connections** tab and click on the **LAN Settings** button.
4. Verify that the "Use proxy server" option is NOT checked. If it is checked, click in the checked box to deselect the option and click OK.

Alternatively you can access this **Internet Options** menu using the **Tools** pull-down menu in Internet Explorer.

To use the web-based management software, launch a suitable web browser and direct it to the IP address of the Router. Type in **http://** followed by the default IP address, **192.168.1.1** in the address bar of the browser. The URL in the address bar should read: **http://192.168.1.1**. Once entered, the user will be prompted to enter the username and password to access the Configuration Manager, as show

below. A new window will appear and you will be prompted for a user name and password to access the web-based manager. Use the default user name “admin” and password “admin” for first time setup. You should change the web-based manager access user name and password once you have verified that a connection can be established. The user name and password allows any PC within the same subnet as the Router to access the web-based manger.



**NOTE:** Do not confuse the user name and password used to access the web-based manager with the ADSL account user name and password needed for PPP connections to access the service provider’s network.



Figure 3-. Enter Network Password dialog box.

## Configure the Router with the Configuration Wizard

The first page that appears after you successfully login displays information about the Router’s Setup Wizard. Tabs across the top of the screen show other available menus: **Home**, **Advanced**, **Tools**, **Status**, and **Help**.

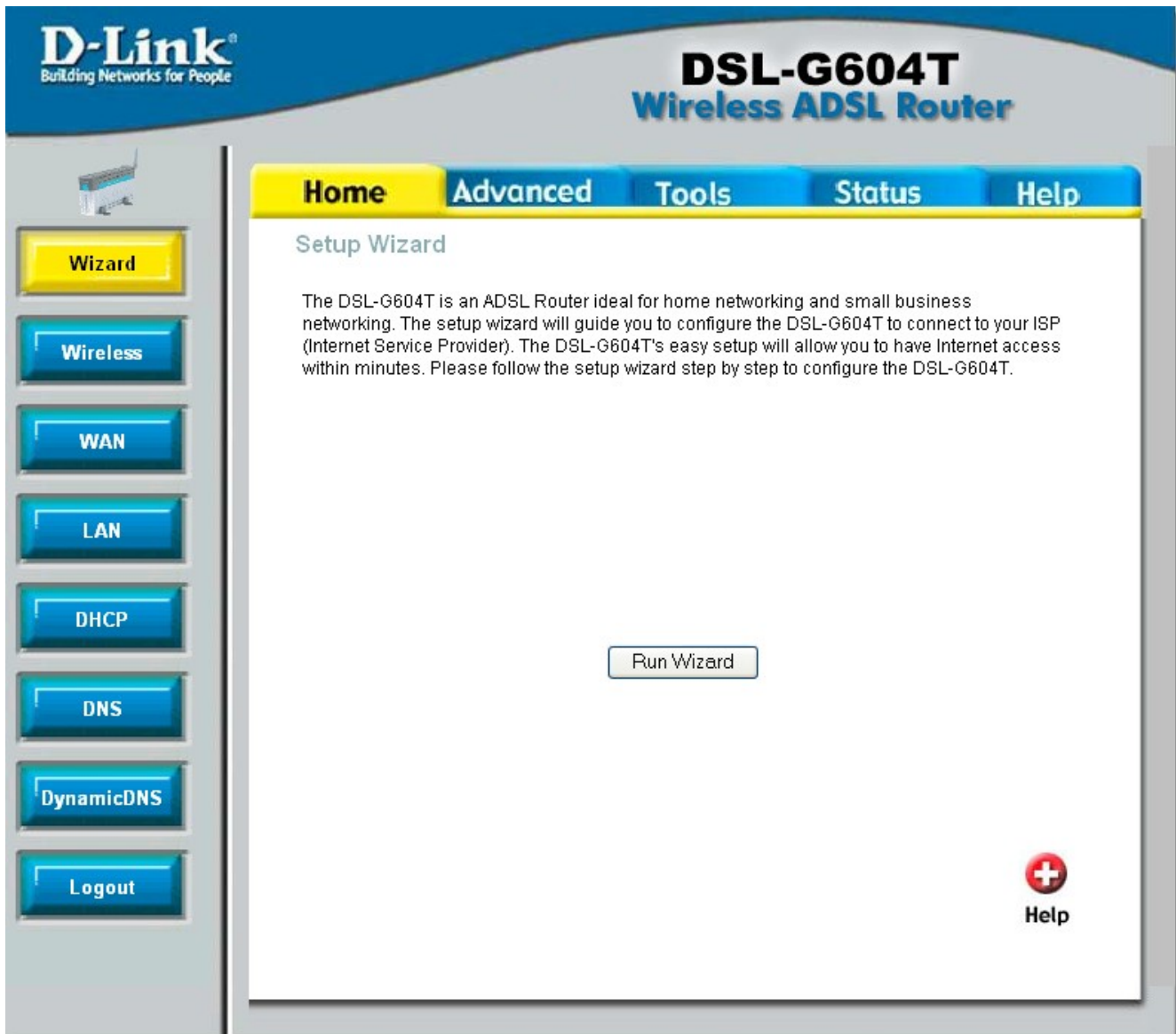
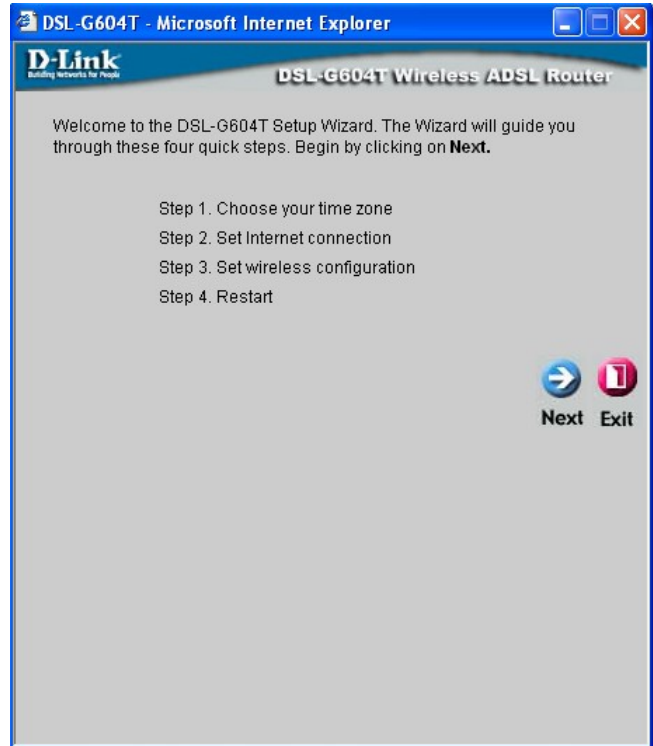

Figure 3-. Home – Setup

When the Router is used to provide Internet access it actually must first access your service provider's network, that is, it must communicate with computers and other modems owned by your service provider. These computers and modems then provide access to the Internet. The Router must be configured to communicate with the systems that give it access to the larger network. The quickest way for you to connect to the Internet is by using the **Setup Wizard**. Click the **Run Wizard** button the following window will appear:

The **Setup** window has four options listed, which will run through in the order given. Each step will be explained in detail. Click **Next** to access Step 1. You may click **Back** during the Setup procedure to return to the previous screen in the Setup Wizard, or **Exit** to exit the Setup Wizard at any time during the procedure.



**Figure 3-. Opening Setup window**

### Step 1: Choose Your Time Zone

In Step 1, you must choose the time zone that best corresponds to the area you are living in by using the pull down menu. Choose the appropriate setting and click **Next** to go on to Step 2.

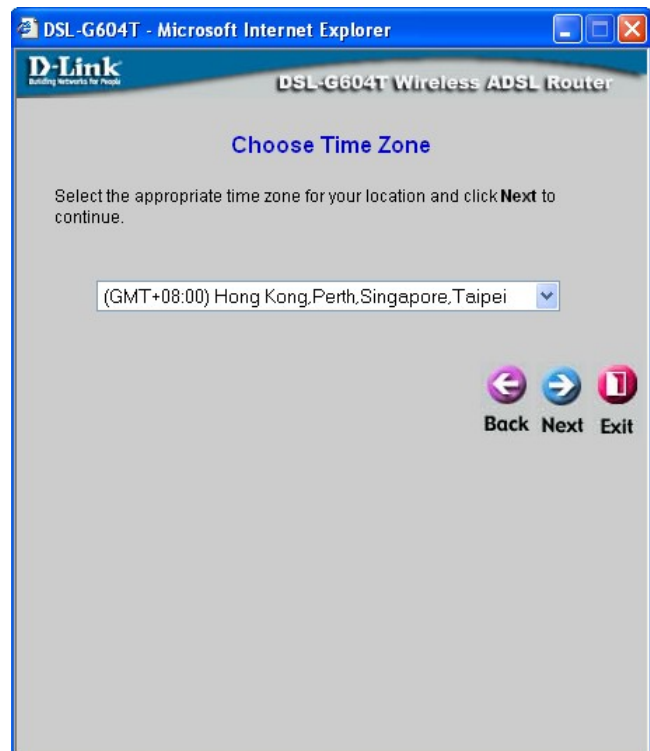

Figure 3- . Choose Time Zone window

Step2 involves choosing the correct connection type mode for your ADSL Router. There are different methods or protocols used to make this communication possible, and both ends of the communication (you and your ISP) must agree on what method to use and how to set up the connection. This is what you want to configure the Router to do: to agree with the service provider's equipment and negotiate the terms of the connection using a language or protocol that both sides understand. This window offers four connection types for the user to choose from. The choice will depend on information provided to you by your ISP. Options available on the DSL-G604T are **Dynamic IP Address**, **Static IP Address**, **PPPoE/PPPoA** and **Bridge Mode**. Simply click the corresponding radio button and click **Next** to go on to the configuration window for that choice.

### Step 2: Setting the ADSL Connection

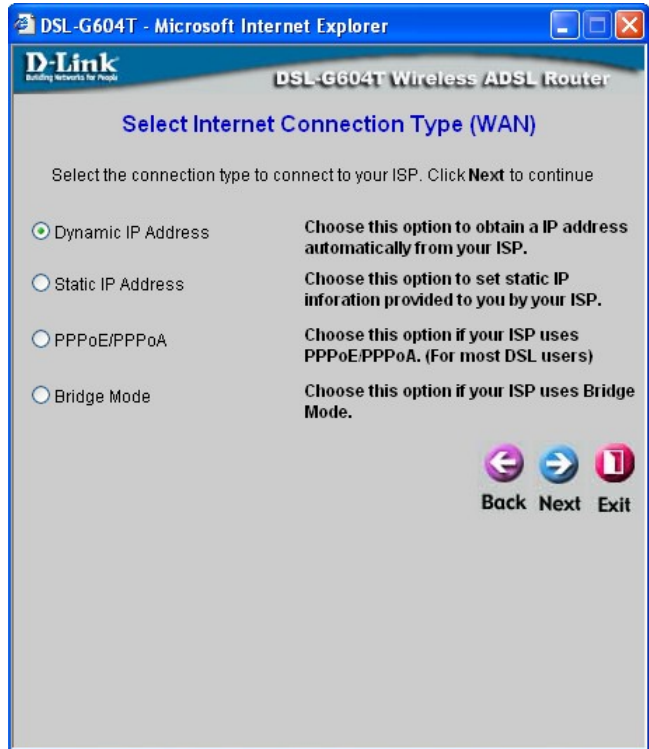

Figure 3-. Set Internet Connection Type window

## Step 2.1: Bridge Mode



**Bridge Mode** is for users who have software on their computer or other network device to accept the connection from your ISP. You may change the PVC (Permanent Virtual Channel) settings, which are defined by two numbers, the **VPI** (Virtual Path Indicator) and the **VCI** (Virtual Channel Indicator). These two values should be provided to you by your ISP. In most cases, the default settings are correct and need not be altered. The second setting is the **Connection Type**, selected by using the pull-down menu. The two choices available to the user here are **1483 Bridged IP LLC** and **1483 Bridged IP Vc-Mux**, and this correct choice should also be provided to you by your ISP. After setting the values listed, click the **Next** button to go to Step 4 of the Configuration Wizard.



Figure 3-. Set 1483 Bridged IP LLC

## Step 4: Restart

In the following window, the user must restart the system to save the settings implemented or go back to choose another option to configure.



Restart window

## Step 2.2: Static IP Address

The following window is used to set the Static IP mode for the Router. A Static IP address is used whenever a known static IP is assigned. The accompanying information such as the Subnet mask, ISP Gateway Address and DNS servers should also be specified in order to be able to connect. These are the servers would enable you to have access to other web servers. Valid IP addresses range from 1.0.0.1 to 255.255.255.255.

To configure the connection for Static, perform the steps listed below. Some of the settings do not need to be changed the first time the device is set up, but can be changed later if you choose. After setting the value listed, click the **Next** button to go to Step 4 of the Configuration Wizard.

The screenshot shows a web browser window titled "DSL-G604T - Microsoft Internet Explorer" displaying the configuration page for the "DSL-G604T Wireless ADSL Router". The page is titled "Set Static IP Address" and contains the following fields and controls:

- Instruction: "Enter the static IP information provided to you by your ISP. Click **Next** to continue."
- VPI: Input field with value "8"
- VCI: Input field with value "35"
- IP Address: Input field with value "0.0.0.0"
- Subnet Mask: Empty input field
- ISP Gateway Address: Empty input field
- Primary DNS Address: Input field with value "168.95.1.1"
- Secondary DNS Address: Empty input field
- Connection Type: Dropdown menu with value "1483 Bridged IP LLC"
- Navigation buttons: "Back", "Next", and "Exit" buttons.

Figure 3-. Set Static IP window

<b>VPI/VCI</b>	If you are told to change the VPI or VCI values, type in the values given to you by your service provider. Many users will be able to use the default settings.
<b>IP Address</b>	Enter the IP address based on the information provided to you by your ISP.
<b>Subnet Mask</b>	Enter the Subnet Mask based on the information provided to you by your ISP.
<b>ISP Gateway Address</b>	Enter the Default Gateway based on the information provided to you by your ISP.
<b>Primary DNS Address</b>	This entry is for the IP address of your primary domain name server, which should also be provided to you by your ISP. The router will first try the <b>Primary DNS Address</b> to resolve a website's URL IP address. If this IP address fails, the router will then try the <b>Secondary DNS Address</b> .
<b>Secondary DNS Address</b>	The IP address of the secondary domain name server will be used to resolve a website's URL IP address if the <b>Primary DNS Address</b> fails. The information in this field should also be provided by your ISP.
<b>Connection Type</b>	There are four Connection Types set in the router to be chosen by using the pull down menu and they are <b>1483 Bridged IP LLC</b> , <b>1483 Bridged IP VC-Mux</b> , <b>1483 Routed IP LLC</b> , <b>1483 Routed IP VC-Mux</b> and <b>IPoA</b> . The correct choice should be told to you by your ISP.

#### **Step 4: Restart**

In the following window, the user must restart the system to save the settings implemented or go back to choose another option to configure.



**Restart window**

### **Step 2.3: Dynamic IP Address**

Choosing the third option and clicking **Next** will lead you to the following window to configure the Router for. Users choosing this option should have software located on their computer or other networking device to establish a connection between you and your ISP. DHCP allows the user to set the Router so it will automatically set IP addresses for other devices on the LAN. For this option, you may change the PVC (Permanent Virtual Channel) settings, which are defined by two numbers, the VPI (Virtual Path Indicator) and the VCI (Virtual Channel Indicator). These two values should be provided to you by your ISP. In most cases, the default settings are correct and need not be altered. The second setting is the Connection Type by using the pull-down menu. The two choices available to the user here are **1483 Bridged IP LLC** and **1483 Bridged IP VcMux**, and this correct choice should also be provided to you by your ISP. The **Cloned MAC Address** field is used to copy the MAC Address of your Ethernet Adapter to the router. Simply enter the **MAC Address** into the space provided and click the **Clone Mac Address** button. After setting the values listed, click the **Next** button to go to Step 4 of the Configuration Wizard.

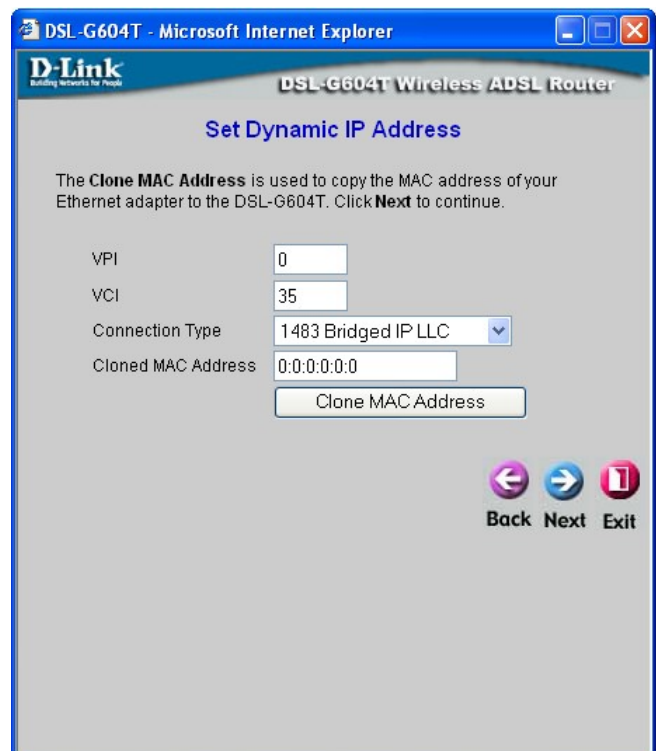

Figure 3-. Set Dynamic IP Address

**Step 4: Restart**



In the following window, the user must restart the system to save the settings implemented or go back to choose another option to configure.



Restart window

### Step 2.4: PPPoE/PPPoA

PPP or Point-to-Point protocol is a standard method of establishing a network connection/session between networked devices. Different forms of PPP include PPPoA and PPPoE, and they involve an authentication process that requires a username and password to gain access to the network. PPPoE (Point to Point Protocol over Ethernet), as described in RFC 2516, is a method of using PPP through the Ethernet network. PPPoA (Point to Point Protocol over ATM) configuration requires the same basic information as the previously discussed PPPoE and both configuration menus are identical. Notice the VPI and VCI values are included. To configure the connection for PPPoE/PPPoA, perform the steps listed below. Some of the settings do not need to be changed the first time the device is set up, but can be changed later if you choose. After setting the values listed, click the **Next** button to go to Step 3 of the Configuration Wizard.

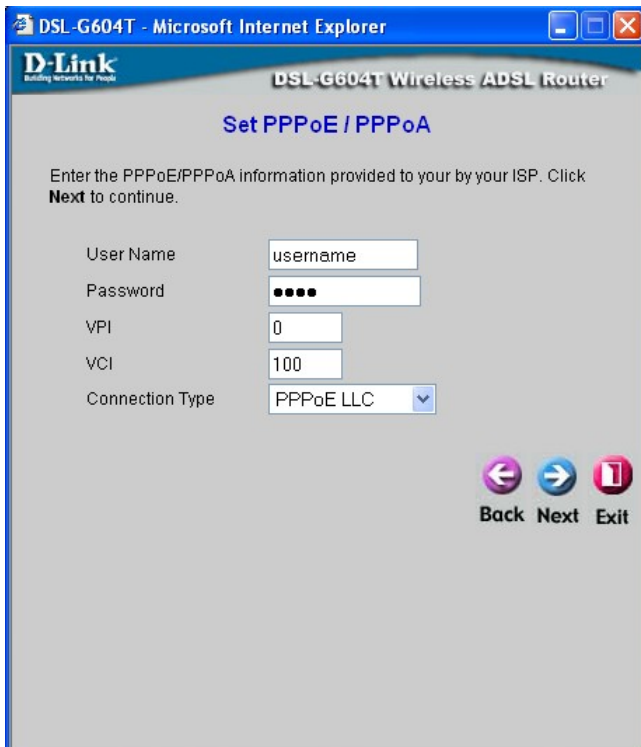

Figure 3-. Set PPPoE window

<b>VPI/VCI</b>	If you are told to change the VPI or VCI values, type in the values given to you by your service provider. Many users will be able to use the default settings.
----------------	---

<b>Username &amp; Password</b>	Type the Username and Password used to verify the identity of your account. Typically, the Username is an account number assigned by your ISP. See your ISP for further information.
<b>Connection Type</b>	Choose between <b>PPPoE LLC</b> , <b>PPPoA LLC</b> or <b>PPPoE VC-Mux</b> depending on the instructions of your ISP.

### **Step 3: Set Wireless Configuration**

To set the wireless LAN connection, enter the SSID and the Channel number to be used for the wireless LAN. The **SSID** can be changed to suit your wireless network. Remember that any wireless device using the access point must have the same SSID and use the same channel. The SSID can be a continuous character string (i.e. no spaces) of up to 16 characters in length. The **Channel** may be changed to channels that are available in your region. Channels available for wireless LAN communication are subject to regional and national regulation. Click next to go to step 4 of the Configuration Wizard.

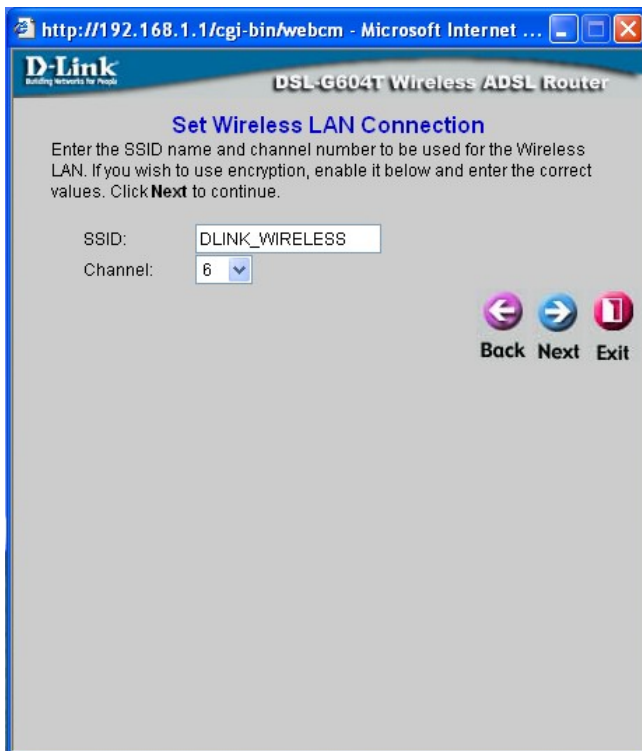

### Set Wireless Configuration

## Step 4: Restart

In the following window, the user must restart the system to save the settings implemented or go back to choose another option to configure.



Restart window

## Home

This tab in the Web Manager will allow the user to set up various configurations in order to connect your Router to the Internet. Much of the information necessary in these screens must be supplied to you by your ISP. Remember to use the key words in bold when asking your ISP for information. This will make your ISP's job easier and therefore your configuration of the modem, much simpler and quicker. Screens to configure under the **Home** tab include **Wireless**, **WAN**, **LAN**, **DHCP**, **DNS**, and **Dynamic DNS**.

## Wireless

Click on the **Wireless** link in the **Home** menu to view the window displayed below. To view information about wireless management and wireless performance please see chapter 5. The three essential settings for wireless LAN operation are the **SSID**, **Channel** and **Security**.

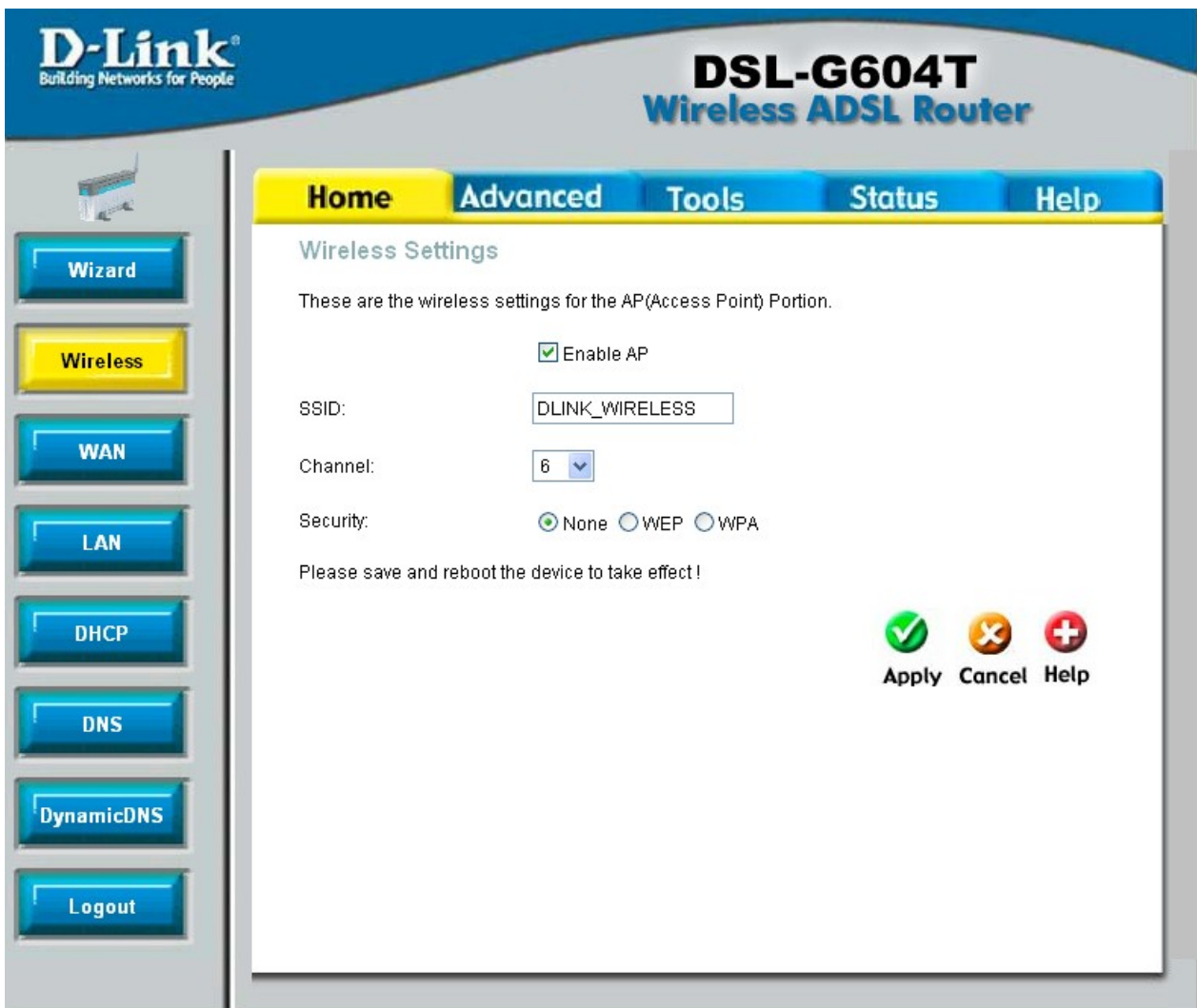

Figure 4- . Wireless window

## Configure Basic Wireless Settings

Follow the instructions below to change basic wireless settings.

1. **To disable the wireless interface:** click in the **Enable AP** check box to remove the check mark and click the **Apply** button. This will immediately disable the wireless access point, it is not necessary to restart the access point to make this change.
2. **If the wireless interface has been disabled:** click the **Enable AP** check box to place a check mark in it. Click the **Apply** button. It is not necessary to restart the access point unless you have also changed the channel or SSID.
3. The **SSID** can be changed to suit your wireless network. Remember that any wireless device using the access point must have the same SSID and use the same channel. The SSID can be a continuous character string (i.e. no spaces) of up to 16 characters in length. To disable SSID sharing, use the Advanced Wireless Setup menu (see next chapter). Click the **Apply** button to save any change to the SSID.
4. The **Channel** may be changed to channels that are available in your region. Channels available for wireless LAN communication are subject to regional and national regulation. Click the **Apply** button to save any change to the Channel.
5. The options for **Security** include None, WEP and WPA.
  - If **None** is selected, wireless transmissions will not be protected.
  - **WEP** (Wireless Encryption Protocol or Wired Equivalent Privacy) encryption can be enabled for security and privacy. WEP encrypts the data portion of each frame transmitted from the wireless adapter using one of the predefined keys. Decryption of the data contained in each packet can only be done if the both the receiver and transmitter have the correct key.
  - **WPA** (Wi-Fi Protected Access) security for wireless communication has been developed to overcome some of the shortcomings of WEP. WPA combines the key generation of WEP with the authentication services of a RADIUS (802.1x) server.

## WAN Configuration

WAN is short for Wide Area Network. The WAN settings can be referred to as the Public settings. All IP information in the WAN settings is public IP addresses, which is accessible on the Internet. There are 8 PVCs pre-configured on this modem and upon initial connection, the appropriate settings should automatically be set for you. Altering any of these fields should only be done if specified by your ISP, who should have all the configuration settings necessary for your connection.

**D-Link**  
Building Networks for People

**DSL-G604T**  
Wireless ADSL Router

Home | Advanced | Tools | Status | Help

Wizard  
Wireless  
**WAN**  
LAN  
DHCP  
DNS  
DynamicDNS  
Logout

**ATM VC Setting**

PVC: Pvc0  
VPI: 8  
VCI: 35  
Virtual Circuit: Enabled  
WAN Setting: PPPoE/PPPoA

**PPPoE/PPPoA**

User Name: username  
Password: ●●●●  
Connection Type: PPPoE LLC  
MTU: 1400 bytes  
MRU: 1492 bytes  
Default Route: Enabled  
NAT: Enabled  
Firewall: Enabled  
IP Control: Dynamic IP  
Static IP: 0.0.0.0

**ATM**

Service Category: UBR  
PCR: kbps  
SCR: kbps

Apply Cancel Help

Figure 4- . Home – WAN window

### ATM VC Setting

The first section of the WAN configuration pages offers fields to set general values for any Virtual Channel chosen for connection to your ISP. This section holds the following fields to configure.



**PVC:** Leave this set at the default value 1 the first time the Router is set up. The modem has been pre-configured for 8 PVCs. The PVC for you should be enabled when you have made your first connection to the Internet. The configured settings for this can be viewed under the **Status** tab, under **Device Info**.

**VPI:** If instructed to change this, type in the VPI value for the initial connection.

**VCI:** If instructed to change this, type in the VCI value for the initial connection.

**Virtual Circuit:** This enables the PVC connection on your modem. Select Enable from the pull down menu to enable the selected PVC.

## **WAN Settings**

The WAN Settings section of this window will allow users to select the type of connection to be used by the router to establish a connection between you and your ISP. Choosing a WAN type will change the window and new settings will appear for the user to configure. The proper selection should be given to you by your ISP.

### **Dynamic IP Address**

Selecting this option in the WAN Settings will change your screen to look like the one seen below. Users choosing this option should have software located on their computer or other networking device to establish a connection between you and your ISP. The Connection Type is chosen by using the pull-down menu. The two choices available to the user here are **1483 Bridged IP LLC** and **1483 Bridged IP Vc-Mux**, and this correct choice should also be provided to you by your ISP. The **Cloned MAC Address** field is used to copy the MAC Address of your Ethernet Adapter to the router. Simply enter the **MAC Address** into the space provided and click the **Clone Mac Address** button. The Maximum Transmission Unit (**MTU**) is a link layer restriction on the maximum number of bytes of data in a single transmission. The default size is 1400 bytes per packet. **NAT** improves network security in effect by hiding the private network behind one global and visible IP address. NAT address mapping can also be used to link two IP domains via a LAN-to-LAN connection. To enable NAT on the Router, use the pull-down menu and select **Enabled**. The **Firewall** allows the Router to enforce policies to protect against certain kinds of attacks. To enable the firewall on the Router, use the pull-down menu and select **Enabled**.

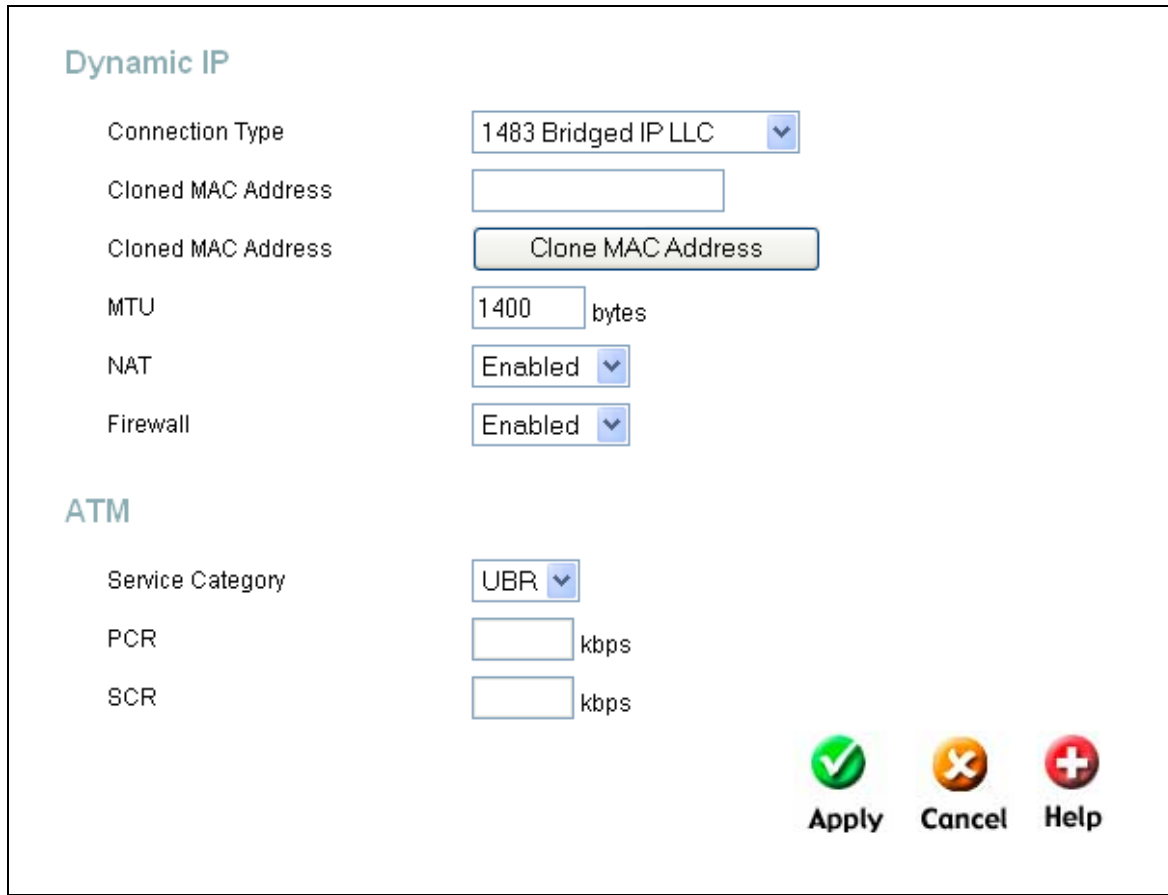

**Dynamic IP**

Connection Type: 1483 Bridged IP LLC

Cloned MAC Address:

Cloned MAC Address: Clone MAC Address

MTU: 1400 bytes

NAT: Enabled

Firewall: Enabled

**ATM**

Service Category: UBR

PCR:  kbps

SCR:  kbps

Apply Cancel Help

Figure 4- . WAN Settings window for Dynamic IP Address

Click **Apply** to set the Dynamic IP settings for your DSL-G604T.

### Static IP Address

Selecting this option in the WAN Settings will change your screen to look like the one seen below. A Static IP address is used whenever a known static IP is assigned. The accompanying information such as the Subnet mask, ISP Gateway Address and DNS servers should also be specified in order to be able to connect. These are the servers would enable you to have access to other web servers. Valid IP addresses range from 1.0.0.1 to 255.255.255.255. All information to be entered in this window must be provided to you by your ISP.

### Static IP

Connection Type:

IP Address:

Subnet Mask:

Gateway Address:

Primary DNS Address:

Secondary DNS Address:

MTU:  bytes

NAT:

Firewall:



  

### ATM

Service Category:

PCR:  kbps

SCR:  kbps

 **Apply**
 **Cancel**
 **Help**

**Figure 4- . WAN Settings window for Static IP Address**

This window holds the following fields for the user to configure.

<b>Connection Type</b>	This field allows the user to choose the connection type used to connect your router to your ISP. The user may choose between <b>1483 Bridged IP LLC</b> , <b>1483 Bridged IP VC-Mux</b> , <b>1483 Routed IP LLC</b> and <b>1483 Routed IP VC-Mux</b> . The correct choice should be told to you by your ISP.
<b>IP Address</b>	Enter the IP address based on the information provided to you by your ISP.
<b>Subnet Mask</b>	Enter the Subnet Mask based on the information provided to you by your ISP.
<b>Gateway Address</b>	Enter the Default Gateway based on the information provided to you by your ISP.
<b>Primary DNS Address</b>	This entry is for the IP address of your primary domain name server, which should also be provided to you by your ISP. The router will first try the <b>Primary DNS Address</b> to resolve a website's URL IP address. If this IP address fails, the router will then try the <b>Secondary DNS Address</b> .
<b>Secondary DNS Address</b>	The IP address of the secondary domain name server will be used to resolve a website's URL IP address if the <b>Primary DNS Address</b> fails. The information in this field should also be provided by your ISP.
<b>MTU</b>	The Maximum Transmission Unit ( <b>MTU</b> ) is a link layer restriction on the maximum number of bytes of data in a single transmission. The default size is 1400 bytes per packet.

<b>NAT</b>	<b>NAT</b> improves network security in effect by hiding the private network behind one global and visible IP address. NAT address mapping can also be used to link two IP domains via a LAN-to-LAN connection. Use the pull-down menu to Enable or Disable NAT on the Router
<b>Firewall</b>	The <b>Firewall</b> allows the Router to enforce policies to protect against certain kinds of attacks. To enable the firewall on the Router, use the pull-down menu and select <b>Enabled</b> .

Click **Apply** to set the Static IP address for the DSL-G604T.

### PPPoE/PPPoA

Selecting this option in the WAN Settings will change your screen to look like the one seen below. PPP or Point-to-Point protocol is a standard method of establishing a network connection/session between networked devices. Different forms of PPP include PPPoA and PPPoE, and they involve an authentication process that requires a username and password to gain access to the network. PPPoE (PPP over Ethernet), as described in RFC 2516, is a method of using PPP through the Ethernet network. PPPoA (PPP over ATM) configuration is over ATM and requires the same basic information as the previously discussed PPPoE. Both configuration menus are identical. To configure the connection for PPPoE/PPPoA, perform the steps listed below. Some of the settings do not need to be changed the first time the device is set up, but can be changed later if you choose.

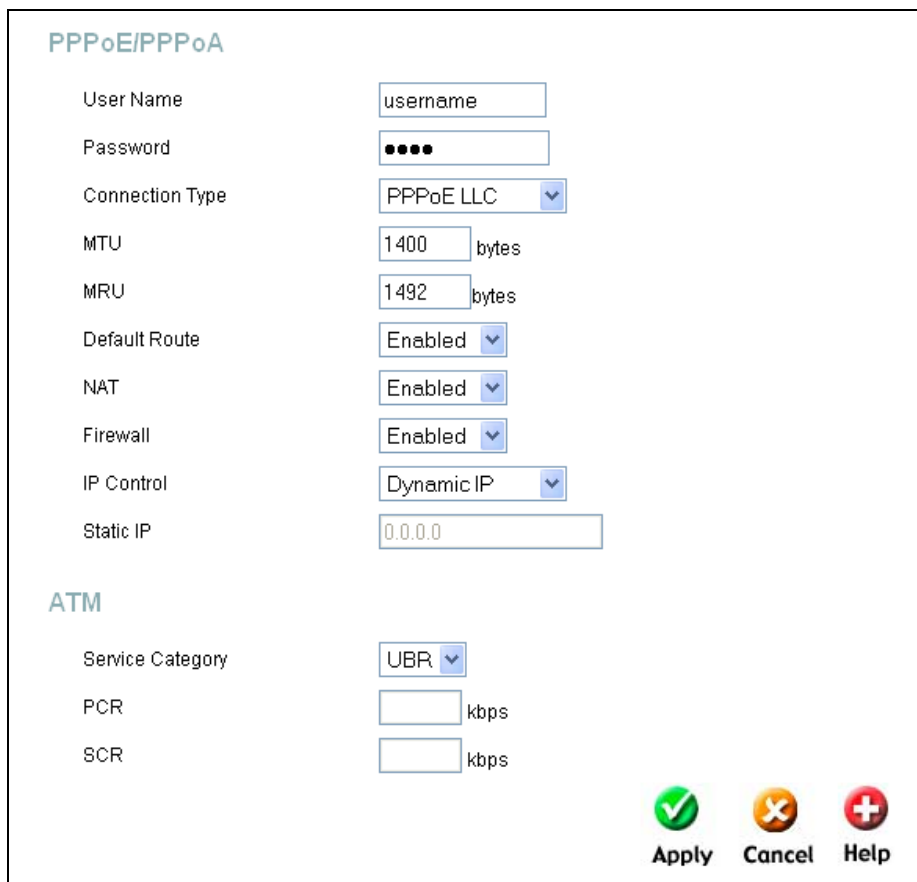

**PPPoE/PPPoA**

User Name:

Password:

Connection Type:

MTU:  bytes

MRU:  bytes

Default Route:

NAT:

Firewall:

IP Control:

Static IP:

**ATM**

Service Category:

PCR:  kbps

SCR:  kbps

Figure 4- . WAN Settings window for PPPoE/PPPoA

This window holds the following fields for the user to configure.

<b>Username &amp; Password</b>	Type the Username and Password used to verify the identity of your account. Typically, the Username is an account number assigned by your ISP. See your ISP for further information.
<b>Connection Type</b>	Choose between <b>PPPoE LLC</b> , <b>PPPoA LLC</b> or <b>PPPoE VC-Mux</b> , depending on the instructions of your ISP.
<b>MTU</b>	The Maximum Transmission Unit ( <b>MTU</b> ) is a link layer restriction on the maximum number of bytes of data in a single transmission. The default size is 1400 bytes per packet. NAT improves network security in effect by hiding the private network behind one global and visible IP address.
<b>MRU</b>	The Maximum Receive Unit ( <b>MRU</b> ) field indicates the maximum number of bytes that can be received by the Router. This MRU's default size is 1492 bytes per packet. Upon initial negotiation with your ISP, the router will tell the ISP that the amount entered here is the largest packet that can be accepted by the router.
<b>Default Route</b>	Click the corresponding radio button if you wish to enable or disable the Default Route. The Default Route is used for outgoing packets, which have an unresolved IP address. If the router is unable to match the destination address on a received packet with a destination address in the routing table, the router uses the default route.
<b>NAT</b>	NAT improves network security in effect by hiding the private network behind one global and visible IP address. NAT address mapping can also be used to link two IP domains via a LAN-to-LAN connection. Use the pull-down menu to Enable or Disable NAT on the Router.
<b>Firewall</b>	The <b>Firewall</b> allows the Router to enforce policies to protect against certain kinds of attacks. To enable the firewall on the Router, use the pull-down menu and select <b>Enabled</b> .
<b>IP Control</b>	This field allows the user to control the WAN IP address of the router. There are three choices for the user: <b>Dynamic IP</b> – Select this option if you wish to have an IP address automatically assigned to the router. <b>Unnumbered IP</b> – Select this option if your ISP has assigned a block of IP addresses for use. <b>Static IP</b> – Select this option if you know the IP address assigned to the router. After selecting this option, the user must enter the known Static IP address in the following field. A Static IP address is used whenever a known static IP is assigned.
<b>Static IP</b>	This field states the Static IP Address of the Router can only be configured when Static IP is chosen in the previous field.

Click **Apply** to implement the PPPoE settings for the DSL-G604T.

### **Bridge Mode**

Selecting this option in the WAN Settings will change your screen to look like the one seen below. **Bridge Mode** is for users who have software on their computer or other network device to accept the connection from your ISP. The **Connection Type** setting is selected by using the pull-down menu. The two choices available to the user here are **1483 Bridged IP LLC** and **1483 Bridged IP Vc-Mux**, and this correct choice should be provided to you by your ISP.

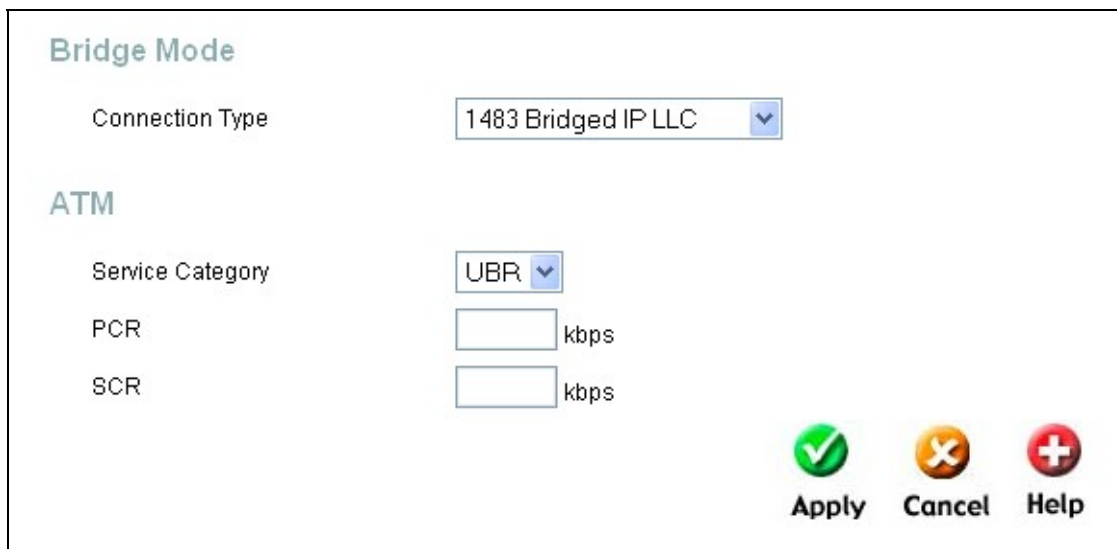

**Bridge Mode**

Connection Type: 1483 Bridged IP LLC

**ATM**

Service Category: UBR

PCR:  kbps

SCR:  kbps

Apply Cancel Help

Figure 4- . WAN Settings window for Bridge Mode

Click **Apply** to implement the Bridge Mode settings for the DSL-G604T.

### ATM

This section of the WAN window allows the user to adjust ATM Quality of Service (QoS) or traffic parameters to suit specific traffic requirements. For applications or circumstances where packet loss or packet delay are a concern, ATM QoS can be adjusted to minimize problems. For most accounts, it will not be necessary to change these settings. Altering QoS settings can adversely affect performance of some commonly used Internet applications.

If you plan to change QoS or traffic parameters, contact your ISP or network services provider for information on what types of adjustment are available or possible for your account. Your ISP may not support the class of service you want to use.

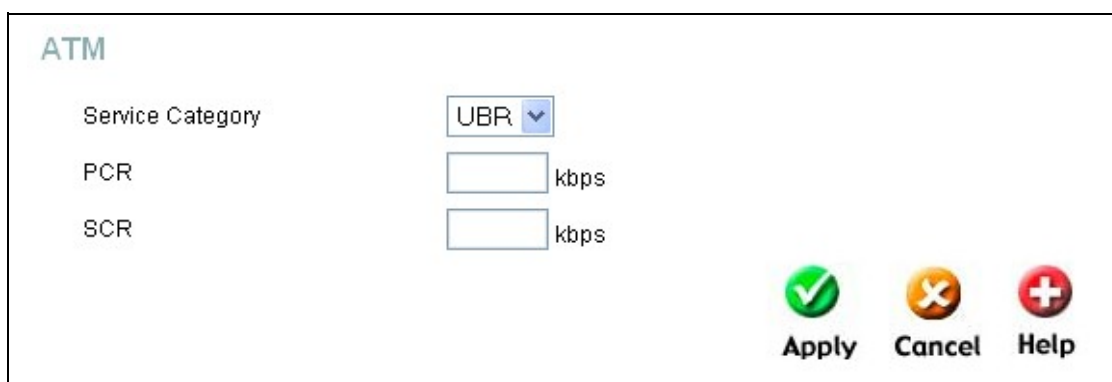

**ATM**

Service Category: UBR

PCR:  kbps

SCR:  kbps

Apply Cancel Help

Figure 4- . ATM settings for the WAN interface

**Service Category:** This field represents the QoS (Quality of Service) feature for the ADSL router. The choices available from the pull down menu include UBR (Unspecified Bit Rate), CBR (Constant Bit Rate) and VBR (Variable Bit Rate). These values should already be set for you and should not be changed unless specified by your ISP.

- **UBR** – Unspecified Bit Rate, this is the default category used for general-purpose Internet traffic where normal levels of packet loss and delay are acceptable. For some applications or for multiple connection accounts, it may be desirable to specify the PCR.
- **CBR** – Constant Bit Rate, usually used in circumstances where very low packet loss and very low Cell Delay Variable (CDV) are desirable.

- **VBR** – Variable Bit Rate, usually used when network traffic is characterized by bursts of packets at variable intervals, and some moderate packet loss and delay is acceptable. This category is typically used for audio and video applications such as teleconferencing. The network must support QoS Class 2 to use VBR.

**PCR:** PCR (Peak Cell Rate) refers to the Bandwidth control on your ADSL router. This field allows you to enter a value representing the maximum bps (bits per second) the ADSL router can receive. This field is limited by the stream coming from your ISP.

**SCR:** SCR (Sustained Cell Rate) refers to the Bandwidth control on your ADSL router. This field allows you to enter a value representing the minimum bps (bits per second) the ADSL router can receive. After making the changes to this screen, click **Apply** to let your changes take effect.

## LAN Configuration

LAN is short for Local Area Network. This is considered your internal network. These are the IP settings of the LAN interface for the DSL-G604T and may be referred to as Private settings. You may change the LAN IP address if needed. The LAN IP address is private to your internal network and cannot be seen on the Internet.

**IP Address:** The IP address of the LAN interface. The default IP address is 192.168.1.1.

**Subnet Mask:** The subnet mask of the LAN interface. The default subnet mask is 255.255.255.0.

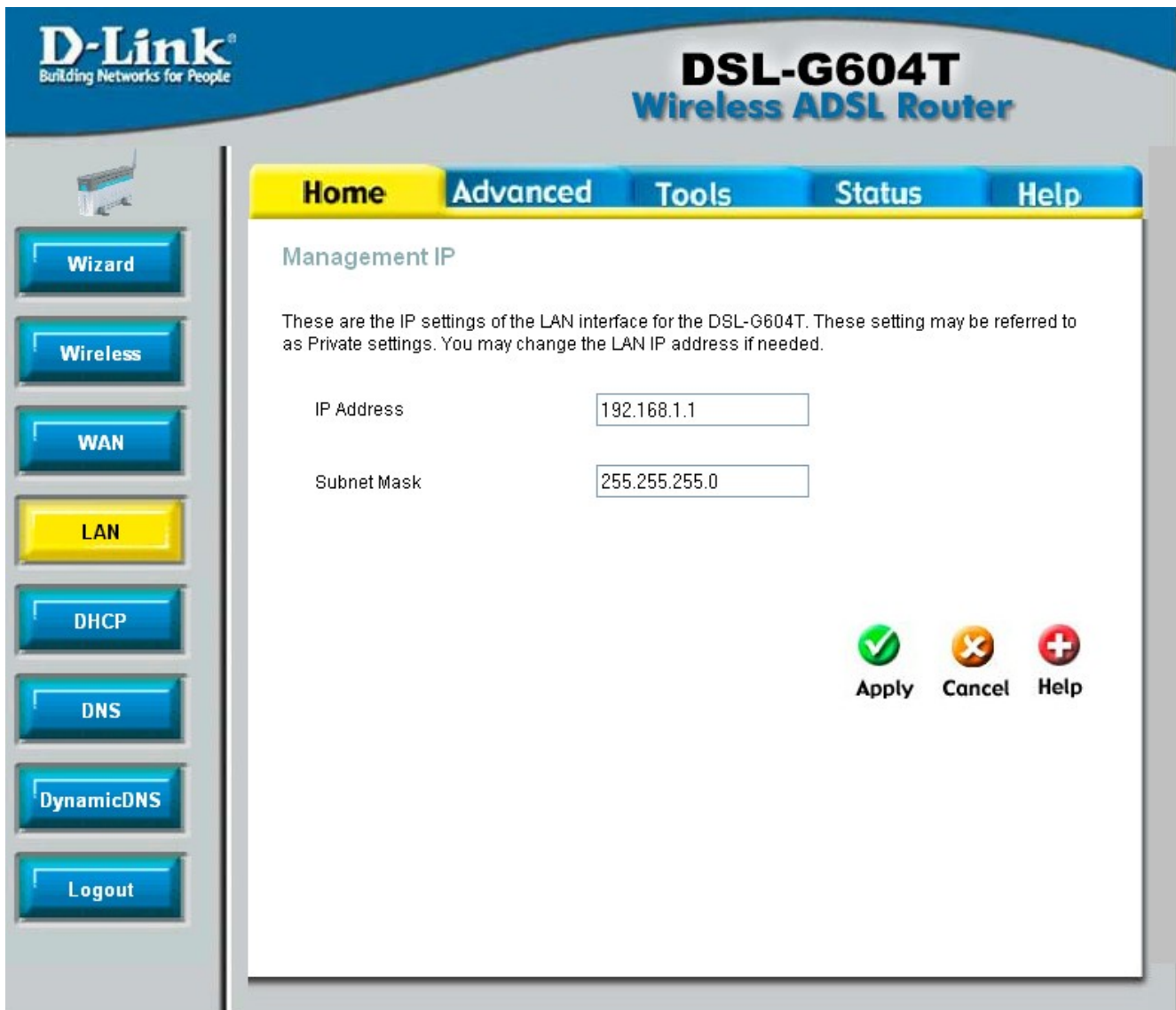

Figure 4- . LAN Settings window

Click **Apply** to implement changes made to this window.



## **DHCP**

Dynamic Host Configuration Protocol (DHCP) allows the gateway to automatically obtain the IP address from a DHCP server on the service provider's network. The service provider assigns a global IP address from a pool of addresses available to the service provider. Typically the IP address assigned has a long lease time, so it will likely be the same address each time the Router requests an IP address. If DHCP is not enabled on the Router, it is necessary for the user to assign a static IP address at each computer on your LAN.

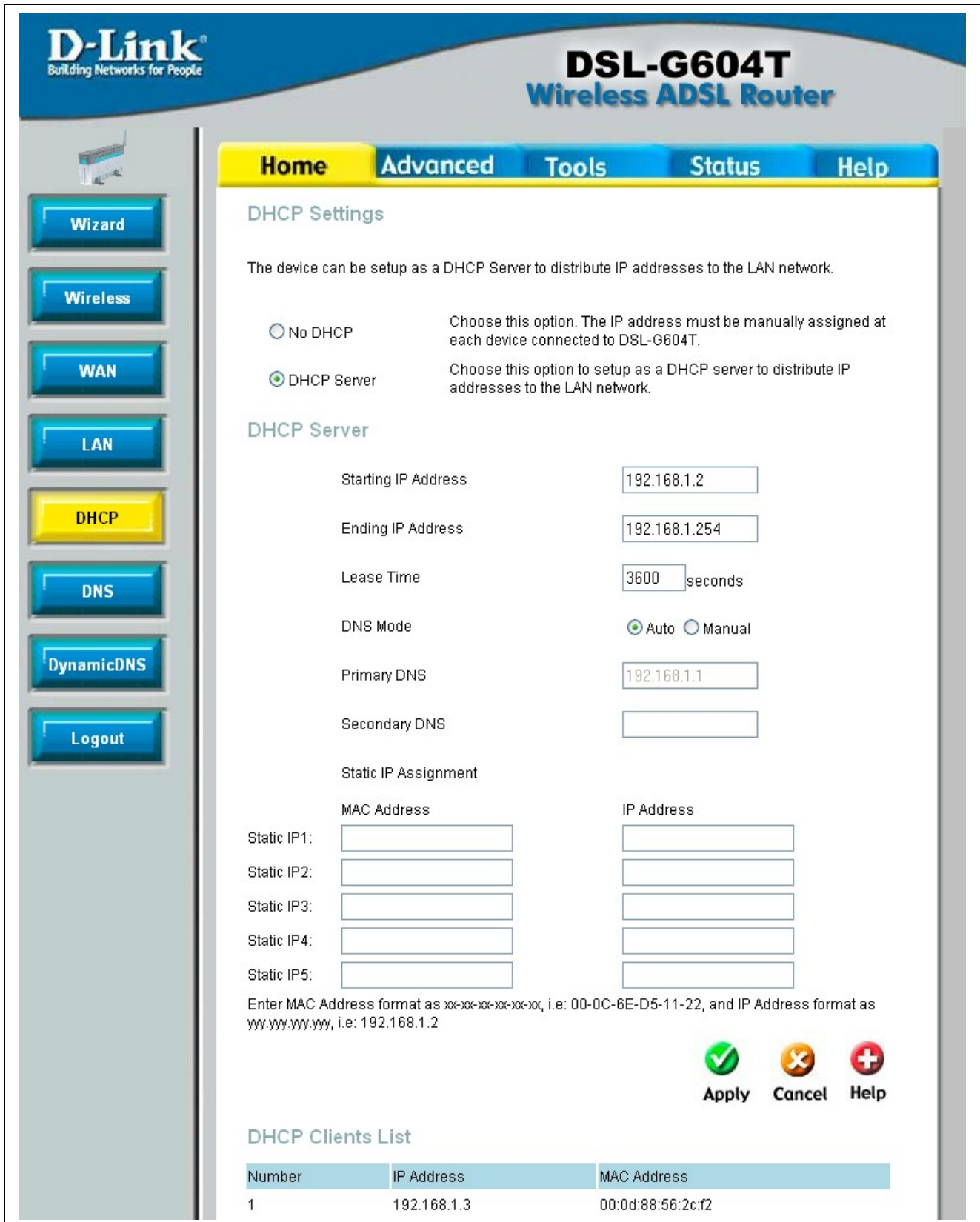

Figure 4- . DHCP configuration window

To setup DHCP for your LAN, first enable the Router as a DHCP server by clicking the corresponding **DHCP Server** radio button in the window above and enter the **Starting IP Address** and **Ending IP address** to create a pool of IP addresses to be assigned to other end nodes (computers, routers, etc.) on

the LAN. The **Lease Time** field is the time the Server will set for devices using DHCP to re-request an IP Address. When using the Router in DHCP mode you may also configure **DNS** settings for the LAN. Click the **DNS Mode** radio button to auto to allow the Router to automatically relay DNS settings to properly configured DHCP clients. Click Manual to manually enter the Primary and Secondary DNS IP addresses. When the Router has been enabled as DHCP Server the administrator of the server can assign a **Static IP** address to each computer on the LAN from the workstation where the DCHP server has been enabled. To assign a Static IP address to a computer on the LAN, enter the IP and MAC address in the Static IP Assignment field. Click **Apply** to implement information set in this table.

## DNS

DNS or Domain Name Server is a system that translates Domain Names into IP addresses. Setting up a DNS will allow the router to contact the DNS to ask it to translate and find a web site you have entered. The following window allows you to set two DNS servers by their IP addresses and these IP addresses should be supplied to you by your ISP.

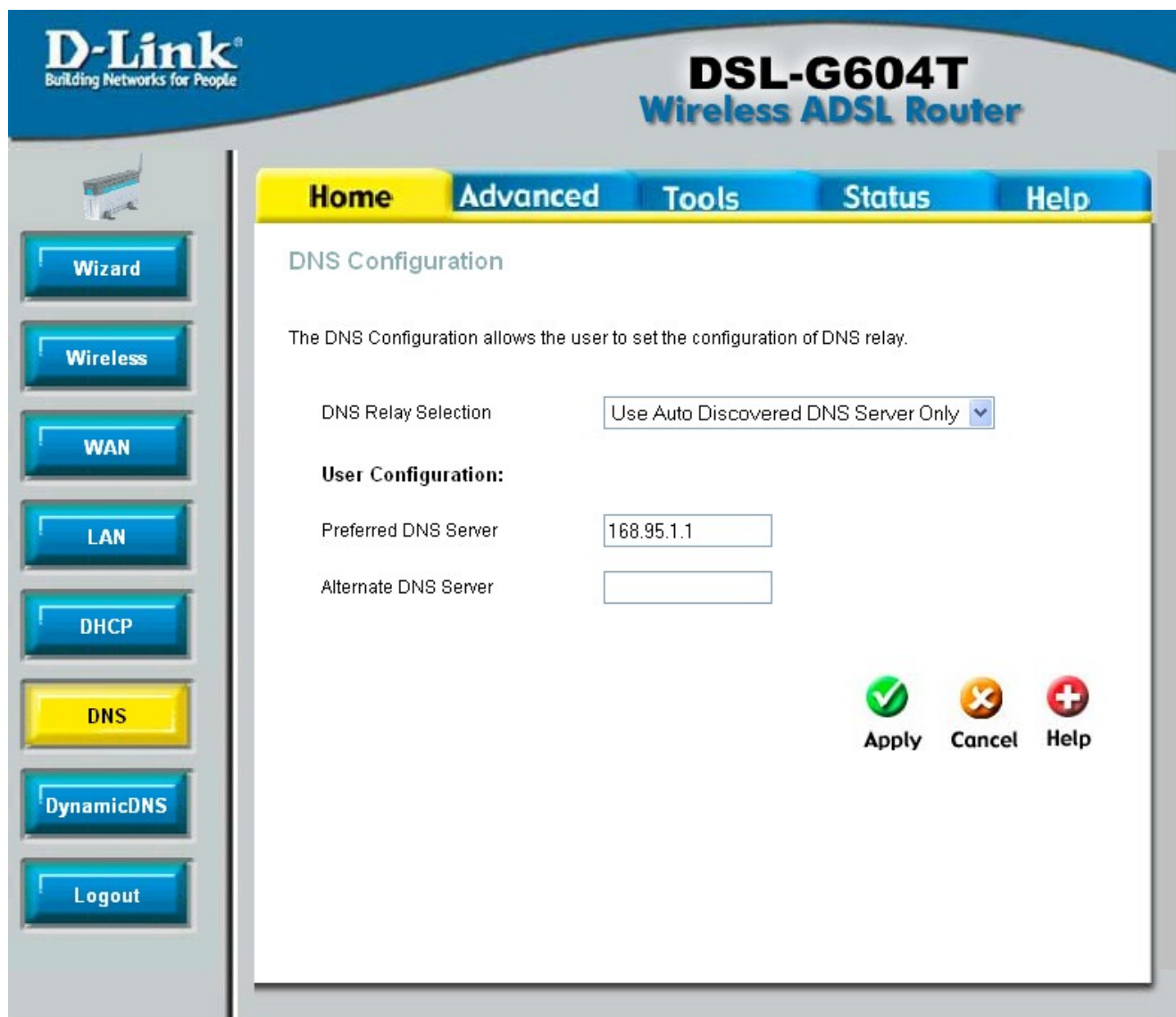

Figure 4- . DNS window

To configure the DNS for the Router, use the DNS Relay Selection pull down menu to select the DNS configuration for the router. There are three choices:

- **Disable DNS** – Selecting this option will disable the DNS function of your router.
- **Use Auto Discovered DNS Server Only** – This choice will enable the router to automatically find the DNS Server for your setup.
- **Use User Discovered DNS Server Only** – This choice will enable the DNS Servers entered in the Preferred DNS Server and Alternate DNS Server fields. These two IP addresses must be stated to you by your ISP.

The router will first try the **Preferred DNS Server** to resolve a website's URL IP address. If that IP address fails to resolve the URL, the Router will then try the **Alternate DNS Server**. Your ISP must provide this information to you. Click **Apply** to set the DNS configurations into the memory of the Router.

## **Dynamic DNS**

The Router supports DDNS, a service that maps Internet domain names to IP addresses. DDNS serves a similar purpose to DNS in that DDNS allows anyone hosting a Web or FTP server to advertise a public name to prospective users. Unlike DNS that only works with static IP addresses, DDNS works with dynamic IP addresses, such as those assigned by an ISP or other DHCP server. DDNS is popular with home networkers, who typically receive dynamic, frequently-changing IP addresses from their service provider. To use DDNS, one simply signs up with a provider and installs network software on their host to monitor its IP address. Please see your ISP for further information.

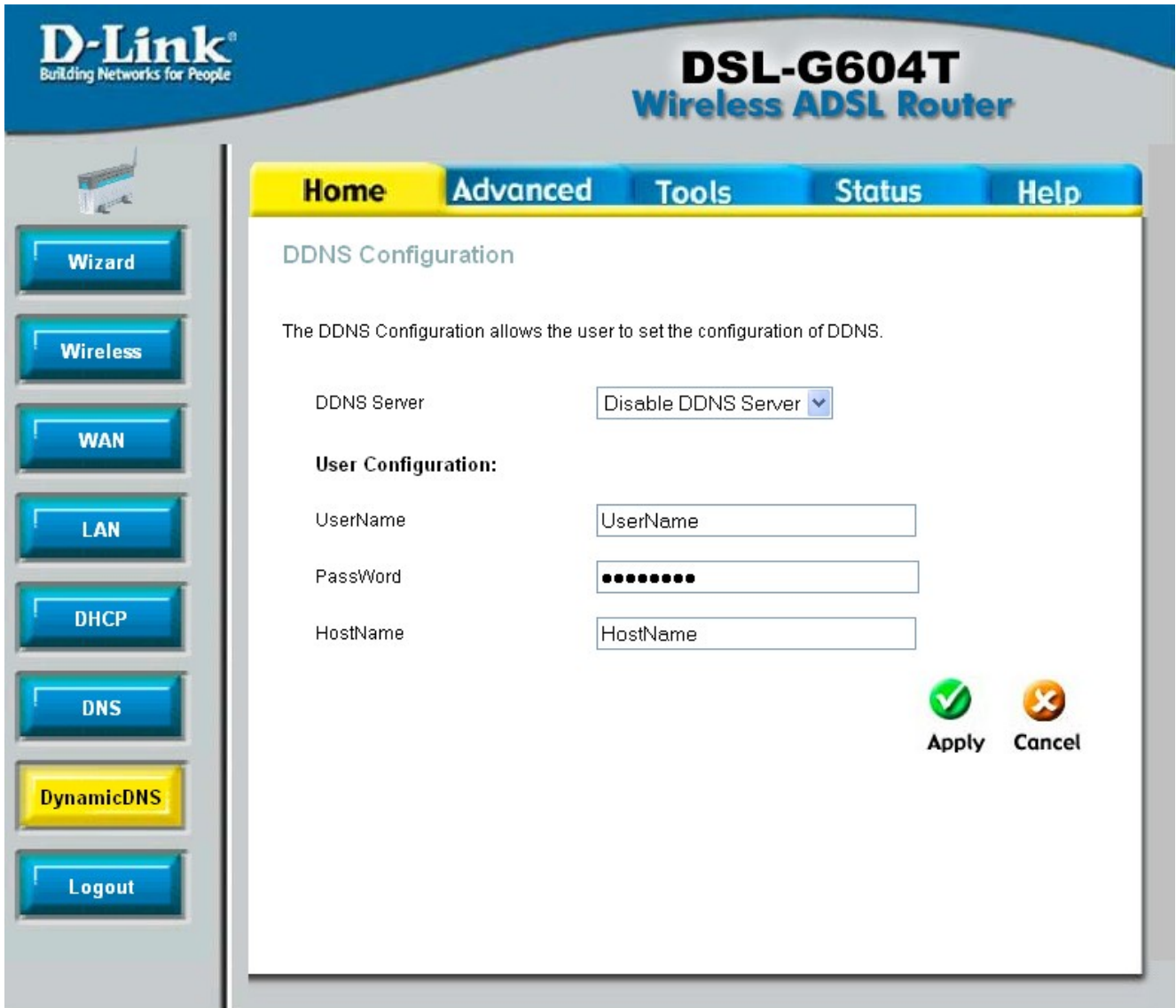

Figure 4- . Dynamic DNS window

## Advanced Configuration

The **Advanced** tab has fifteen windows for you to view and configure: **UPnP**, **Virtual Server**, **LAN Clients**, **SNMP**, **Filters**, **Bridge Filters**, **Routing**, **DMZ**, **Firewall**, **RIP**, **PPP**, **ADSL**, **ATM VCC**, **Wireless Management**, and **Wireless Performance**.

### UPnP

UPnP supports zero-configuration networking and automatic discovery for many types of networked devices. When enabled, it allows other devices that support UPnP to dynamically join a network, obtain an IP address, convey its capabilities, and learn about the presence and capabilities of other devices. DHCP and DNS service can also be used if available on the network. UPnP also allows supported devices to leave a network automatically without adverse effects to the device or other devices on the network.

UPnP can be supported by diverse networking media including Ethernet, Firewall, phone line and power line networking.

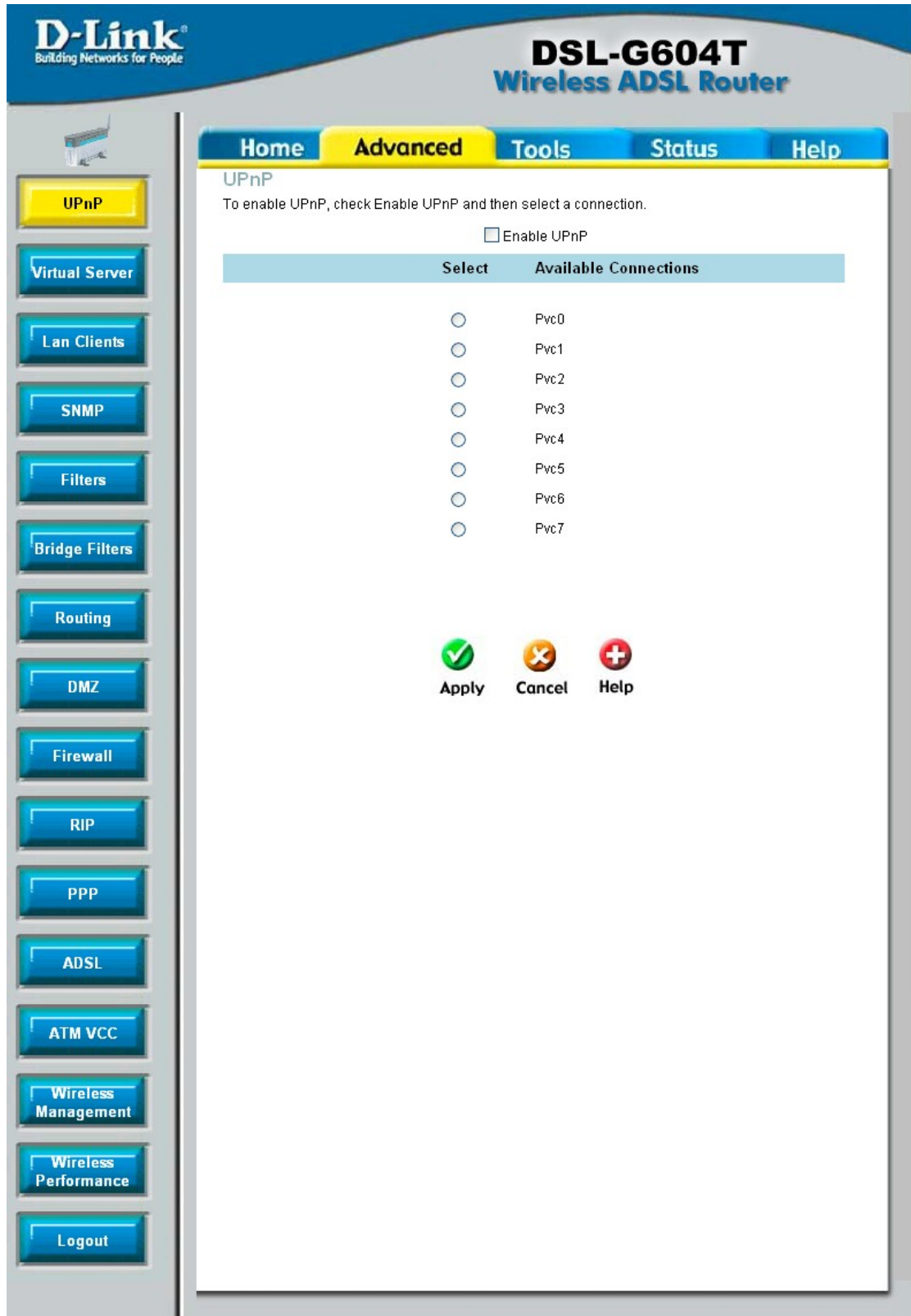

Figure 5- . UPnP window

To enable UPnP for any available connection, click to check the **Enable UPnP** selection box, select the connection or connections on which you will enable UPnP listed under **Available Connections** and click the **Apply** button.

## **Virtual Server**

To view the following window, click on the **Advanced** tab at the top of the window and then click the **Virtual Server** button to the left. The **Virtual Server** will allow remote users access to various services outside of their LAN through a public IP address, such as FTP (File Transfer Protocol) or HTTPS (Secure Web). Select a connection type and enter an IP address for the virtual server. After configuring the Router for these features, the Router will redirect these external services to an appropriate server on the users' LAN. To choose a particular service click a radio button from the category list and highlight the service from the Available Rules list. Click **Add**, and then reboot to apply the rule.



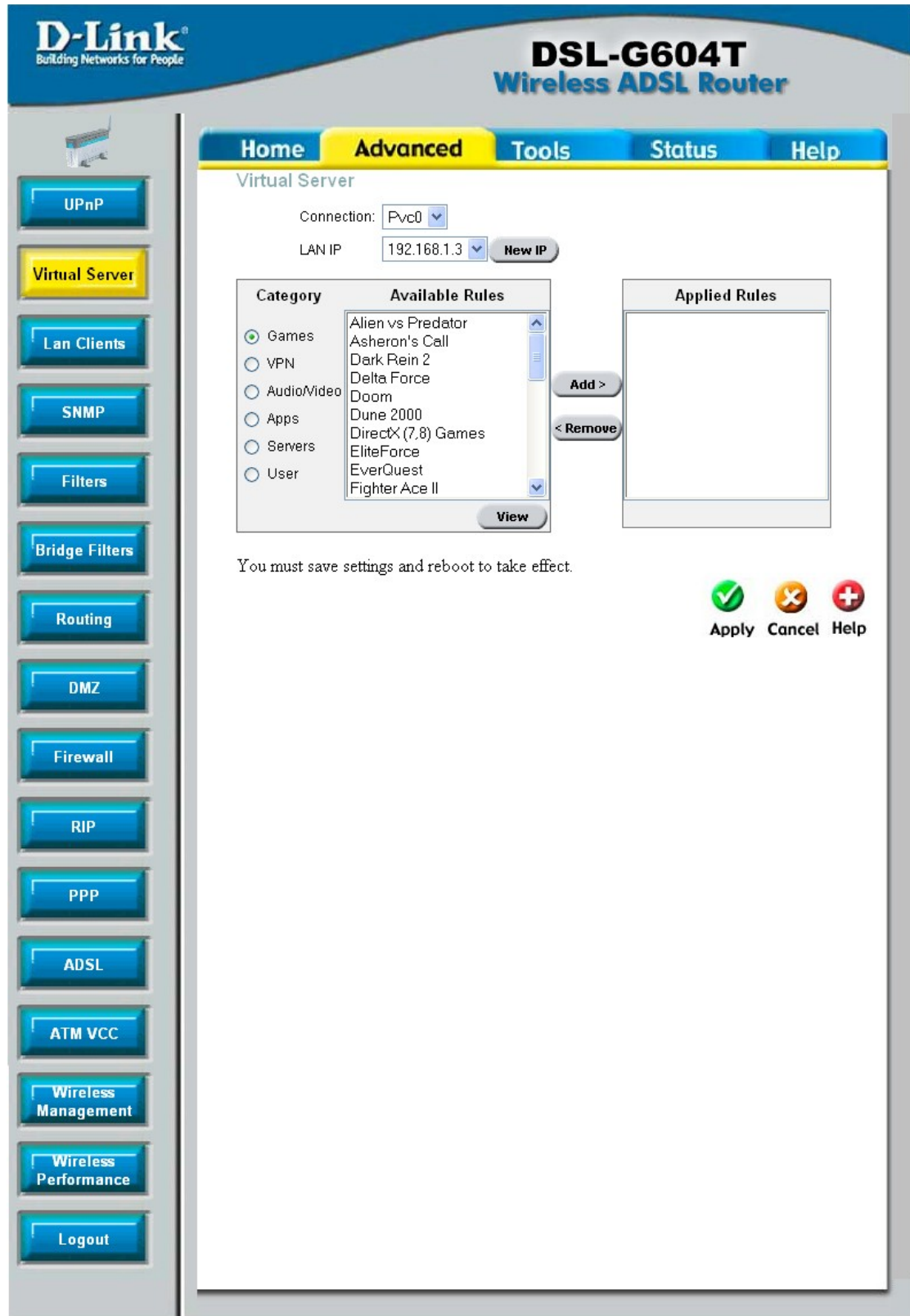

Figure 5- . Virtual Server window

## LAN Clients

The LAN Clients menu is used when establishing Port Forwarding, Access Control and Advanced Security rules for IP addresses on the LAN. This menu can be accessed directly by clicking on the

**LAN Clients** button or hyperlink in the **Advanced** setup menu. You can also click on the New IP button located in the Port Forwarding, Access Control and Advanced Security menus to access this menu. In order to use these advanced features it is necessary to have IP addresses available for configuration. If there are no IP addresses listed in the LAN Clients menu, it will not be possible to configure Port Forwarding, Access Control and Advanced Security. Use the LAN Clients menus to add or delete static IP addresses for the advanced functions mentioned above, or to Reserve a Dynamically assigned IP address for an advanced function. Dynamically assigned IP addresses will only be listed if DHCP is enabled on the Router.

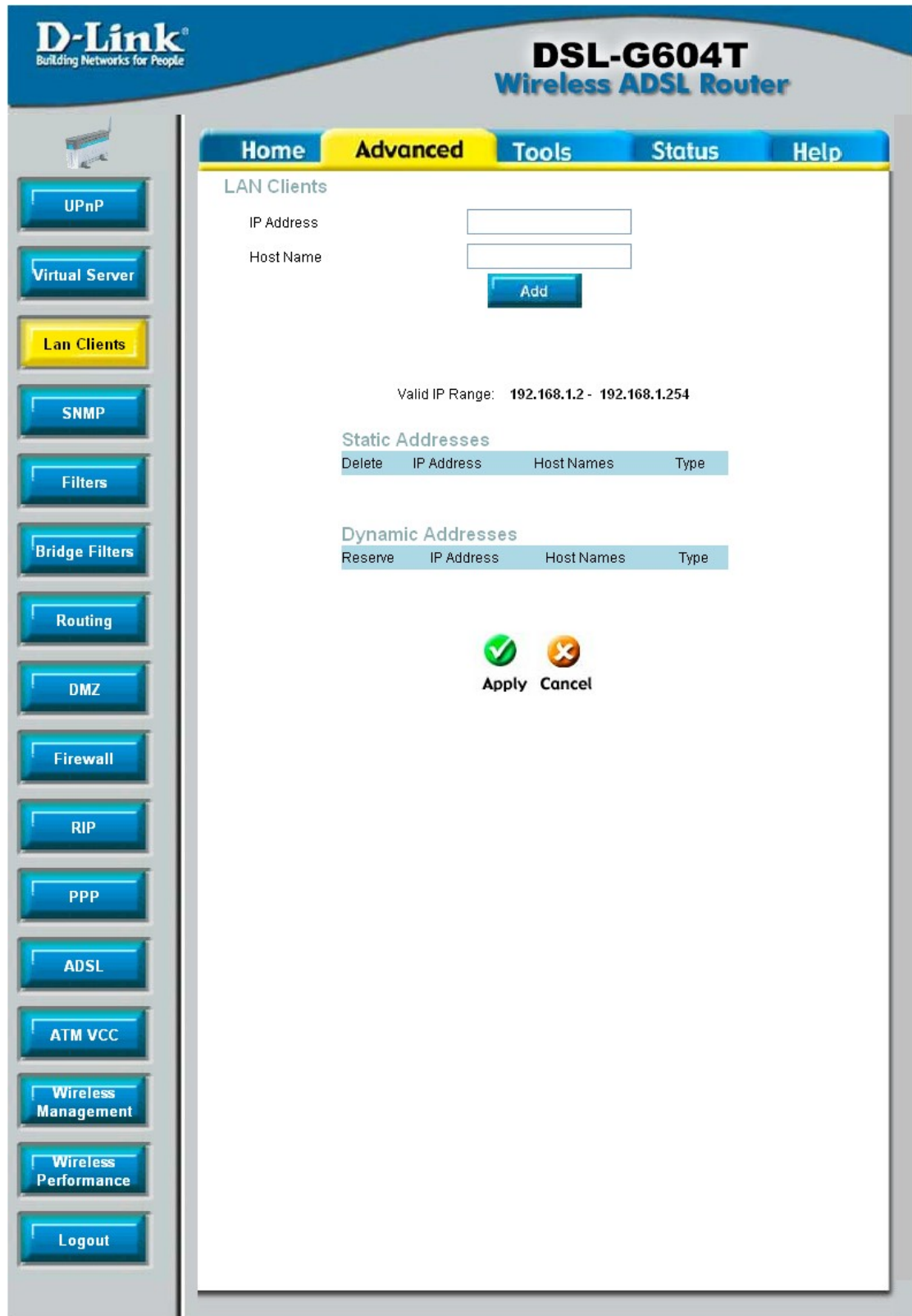

Figure 5- . LAN Clients Window

To add a static IP address to the list of available IP addresses, type an IP address that falls within the range a available IP addresses and click on the **Add** button. In the example above, available addresses range from 10.0.0.1 to 10.255.255.254. Any addresses added will appear in the list of **Static Addresses** available for advanced configuration. These addresses can then be used in the other Port

Forwarding, Access Control and Advanced Security menus. To delete an IP address from the list of Static Addresses, click the **Delete** box for the address or addresses you want to eliminate and click on the **Apply** button.

Dynamically assigned IP addresses may be reserved so that the LAN IP address for the device does not expire. This will create a permanent entry for the device in the ARP table and in effect, it becomes a static IP address. Click to check the **Reserve** box for the address or addresses you want to reserve and click the **Apply** button. These reserved addresses will no longer be available for DHCP assignment and will be listed in the Static IP Addresses table.

## **SNMP**

This menu can be accessed directly by clicking on the **SNMP** button or hyperlink in the **Advanced** setup menu. Simple Network Management Protocol (SNMP) is an OSI Layer 7 Application designed specifically for managing and monitoring network devices. SNMP enables network management stations to read and modify the settings of gateways, routers, switches, and other network devices. Use SNMP to configure system features for proper operation, performance monitoring, and detection of potential problems in the Router or network.

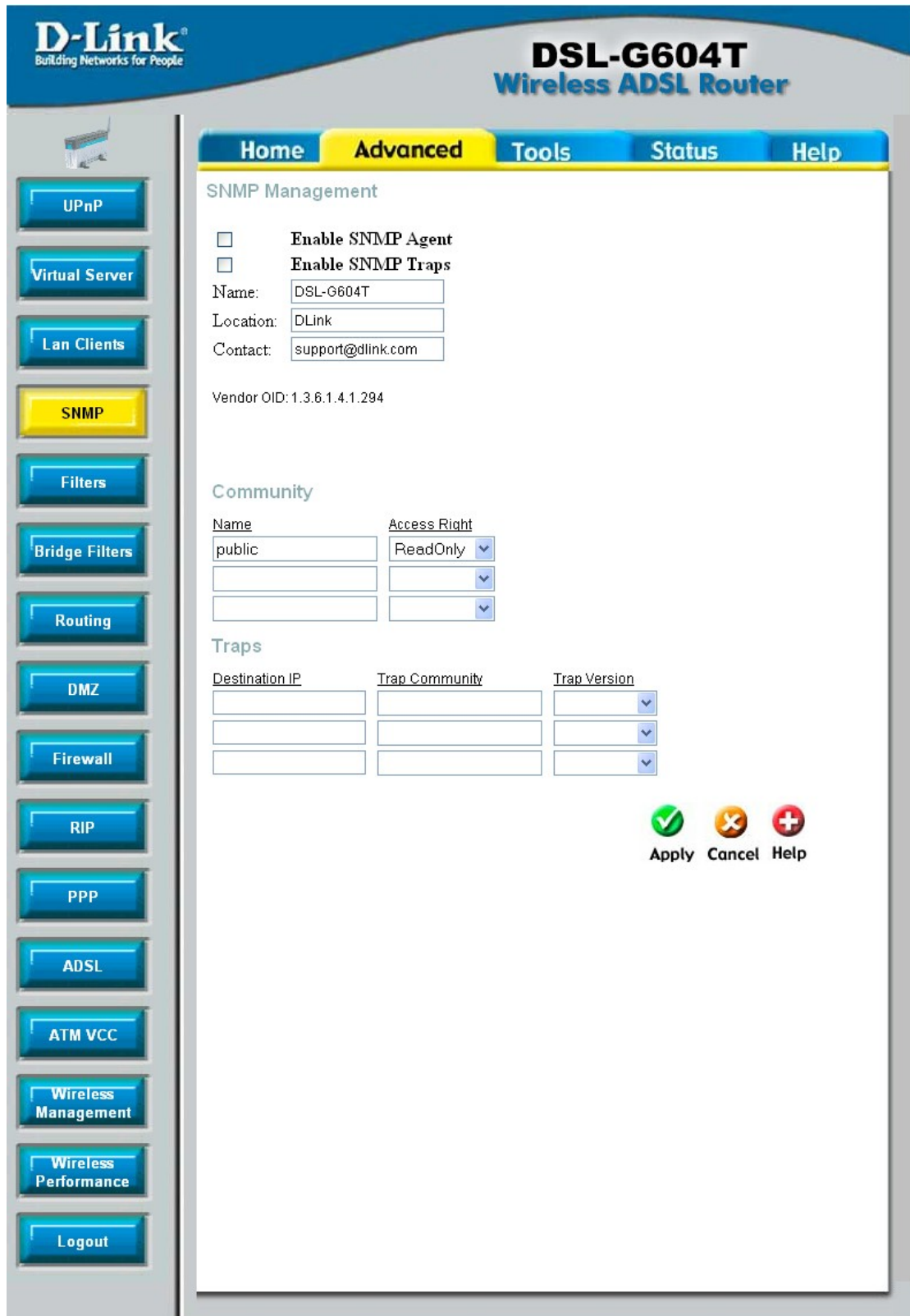

Figure 5- . SNMP window

Under **SNMP Management**, enable or disable **SNMP Agent** or **SNMP Traps** by using the check boxes. An SNMP Agent is software that runs locally on the device. A defined set of variables (managed objects) is maintained by the SNMP agent and used to manage the device. Traps are messages that alert network personnel of events that occur on the Switch. The events can be as serious

as a reboot (someone accidentally turned OFF the Switch), or less serious like a port status change. The Router generates traps and sends them to the trap recipient (or network manager). Typical traps include trap messages for Authentication Failure, Topology Change and Broadcast/Multicast Storms. In the **Name**, **Location** and **Contact** fields, enter the appropriate information of the Network Administrator. Under **Community**, enter the name of an SNMP community string that defines the relationship between the SNMP manager and an agent. The community string acts like a password to permit or deny access to an agent on the Router. The defining characteristic associated with the community string is the **Access Right**. The agent's access right can be set as either read/write or read-only. Under **Traps** enter the **Destination IP address** and **Trap Community Name** so that the agent sends traps to the management server. The **Trap Version** can also be set to either *SNMP V1* (to specify that SNMP version 1 will be used) or *SNMPv2c*, which supports both centralized and distributed network management strategies. *SNMP V2c* includes improvements in the Structure of Management Information (SMI) and adds some security features.

## **Filters**

The following window will aid the router's administrator in configuring filters for IP addresses. There are two types of filters that the administrator can configure. **Outbound Filters** are for administrators who wish to deny clients on their LAN from accessing certain virtual ports or IP addresses on the Internet. **Inbound Filters** are for administrators who wish to deny IP addresses or virtual ports from outside the router (on the Internet) from accessing the Internal LAN of the router. Click the corresponding radio button to configure Outbound or Inbound Filters. Both screens are identical in configuration.

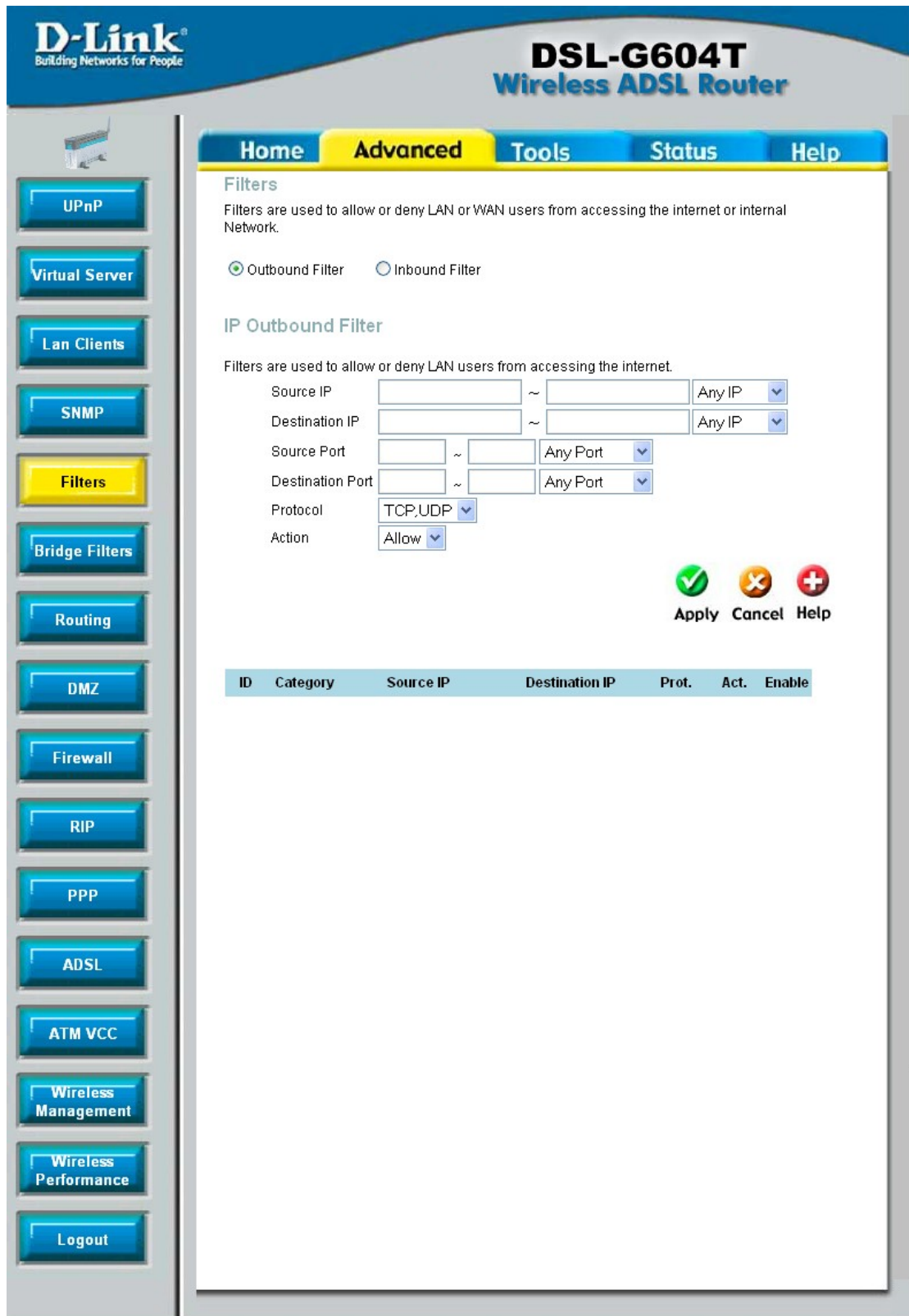

Figure 5- . Filters window

To configure filters for the router, configure the following fields and click **Apply**.

<b>Source IP</b>	Enter an IP address or range of addresses from which to block or allow packets. This field may also be used to block a set of subnet masks by using the corresponding pull down menu.
------------------	---

<b>Destination IP</b>	Enter an IP address or range of addresses to which to block or allow packets from being sent. This field may also be used to block a set of subnet masks by using the corresponding pull down menu.
<b>Source Port</b>	Enter a port or range of ports from which to block or allow packets. This field can only be configured if TCP or UDP is selected in the Protocol field. The Safe Range option in the pull down menu is for ports that have a higher value than 1024.
<b>Destination Port</b>	Enter a port or range of ports to which to block or allow packets from being sent. This field can only be configured if TCP or UDP is selected in the Protocol field. The Safe Range option in the pull down menu is for ports that have a higher value than 1024.
<b>Protocol</b>	Use the pull down menu to select the protocol type to be used for this filter. The user may choose between <b>TCP</b> , <b>UDP</b> or <b>TCP UDP</b> .
<b>Action</b>	This field states allows the user to choose the course of action for this filter to take. The user may choose <b>Allow</b> to allow packets to be forwarded to end nodes configured in the previous fields. The user may choose <b>Deny</b> to block packets from being forwarded to end nodes configured in the previous fields.

Properly configured filters for the router will appear in the table in the bottom half of the filters window. Click **Apply** to set the filters configured for this router.

## Bridge Filters

Bridge filters are used to block or allow various types of packets through the WAN interface. This may be done for security or to improve network efficiency. The rules are configured for individual devices based on MAC address. Filter rules can be set up for source, destination or both. You can set up filter rules and disable the entire set of rules without losing the rules that have been configured.



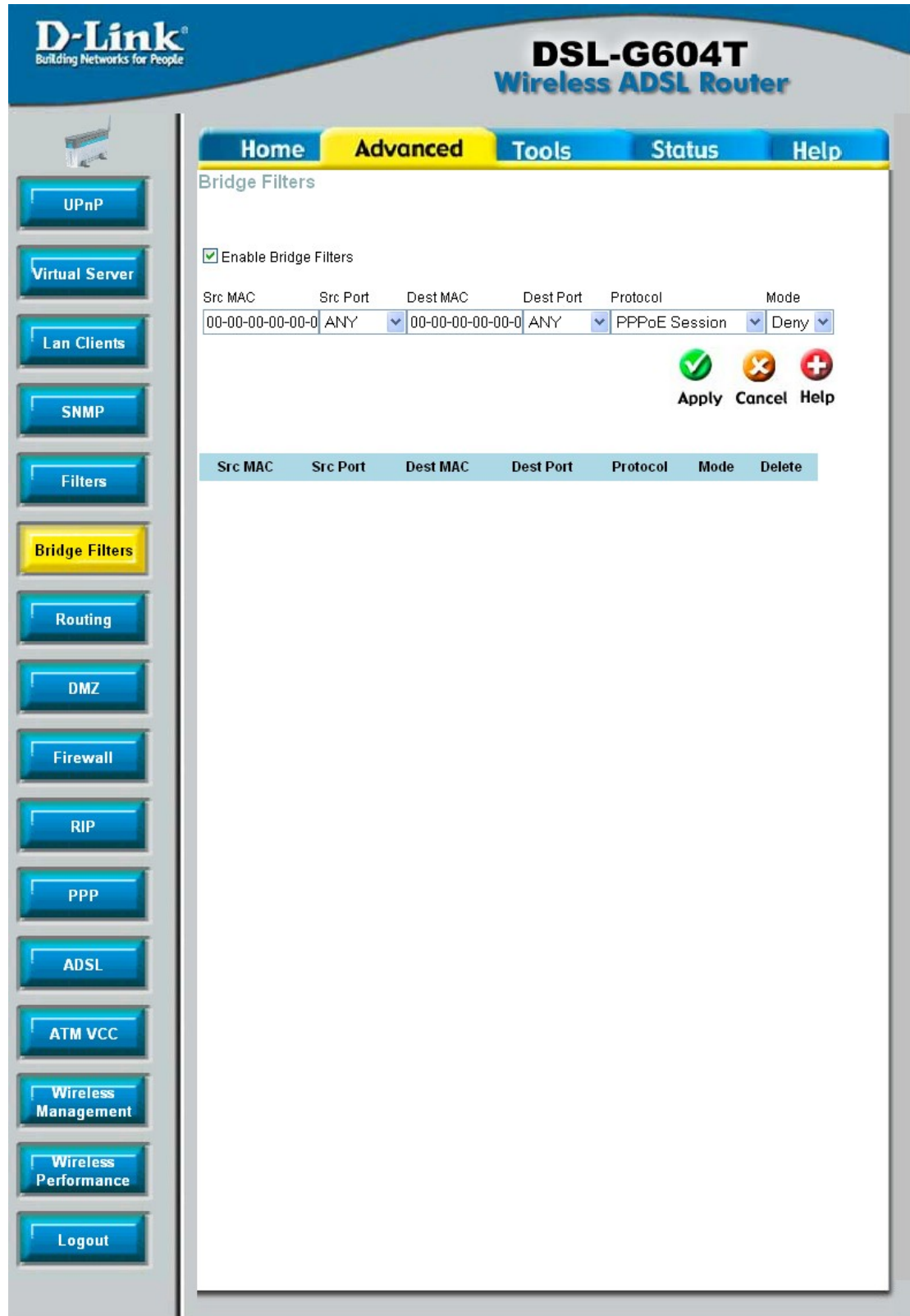

Figure 5- . Bridge Filters window

To add a bridge filter rule, check **Enable Bridge Filters**, type in a Source MAC, a Destination MAC or both in the entry fields. Select *Any* to apply the rule to any protocol that the router receives. The user may also specify a protocol to be filtered by using the pull-down menu, and then choose either *Allow*, to allow the specified protocol to pass through the router, or *Deny* to filter the protocol from the

router. The protocols that may be specifically allowed or denied to pass through the WAN interface are *IPv4*, *IPv6*, *RARP*, *PPPoE Discovery* and *PPPoE Session*. Click the **Add** button. The rule will appear in the entry field below as it is currently configured. To remove a bridge filter from the table in the bottom half of the window, click to select the corresponding **Delete** box, and then click **Apply**. Remember to save the configuration changes.

## **Routing**

Clicking the **Routing** tab will lead you to this window, which is used to manually enter a routing entry for the Router. Routing entries are used when known gateways and hops on the network are known to the user. Unless instructed by your ISP or if you have a greater knowledge of networking, this window should not be necessary to configure as the LAN IP settings should be sufficient for your connection.

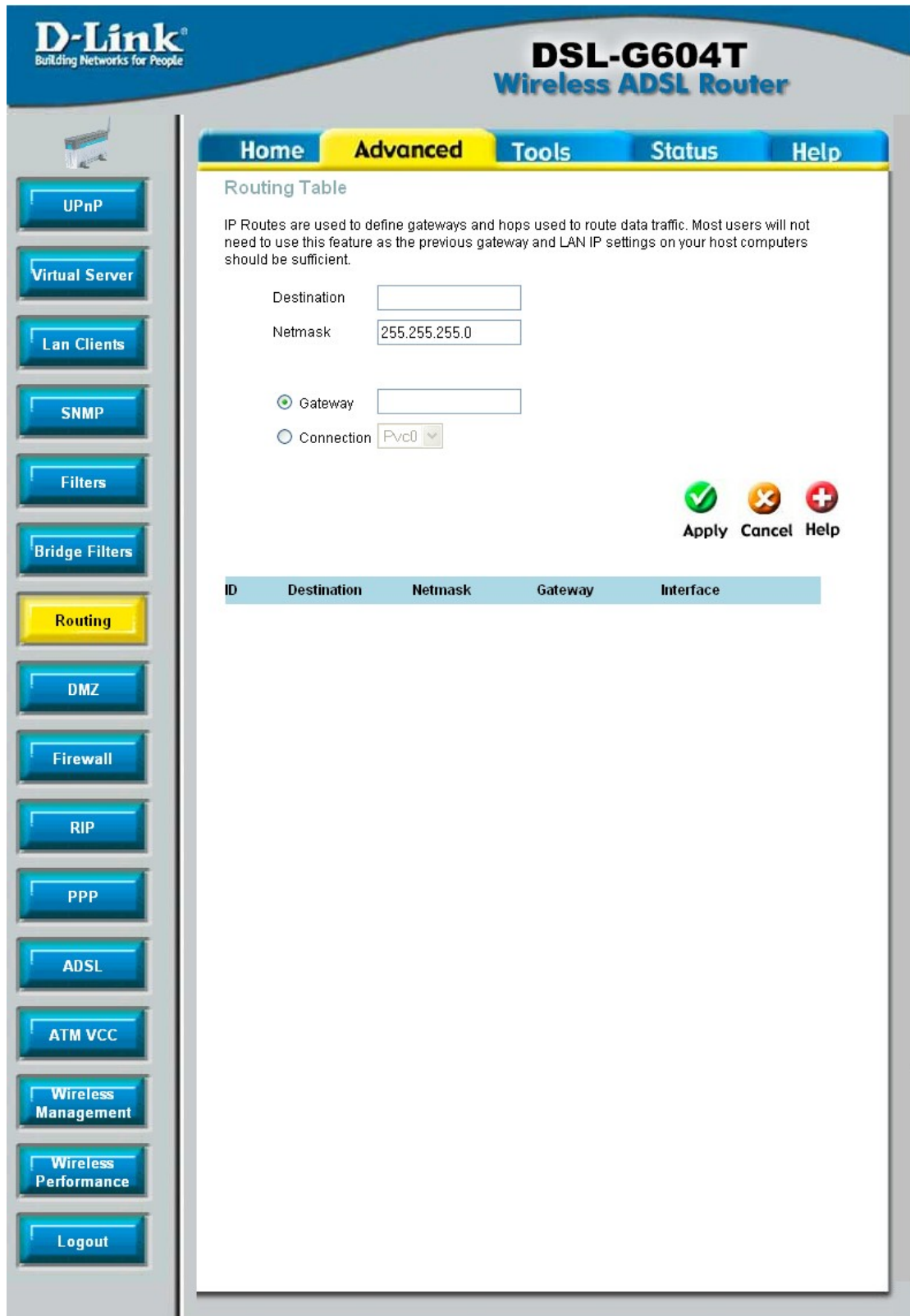

Figure 5- . Routing window

The user may configure the following fields for Static routing on the router:

<b>Destination</b>	Enter the host IP address or the remote network that will be used for static routing on the router.
--------------------	---

<b>Netmask</b>	Enter the Subnet Mask to be used for static routing.
<b>Gateway</b>	Enter the gateway device's IP address. This is an IP address of a device that will allow the user to contact the remote network or Host IP address. This field cannot be configured or used if the following field, <b>Connection</b> , has been selected.
<b>Connection</b>	Choose a PVC from the corresponding pull-down menu to be used for static routing. This field cannot be configured or used if the previous field, <b>Gateway</b> , has been selected.

Click **Apply** to set the routing information configured.

## DMZ

Firewalls may conflict with certain interactive applications such as video conferencing or playing Internet video games. For these applications, a firewall bypass can be set up using a DMZ IP address. The DMZ IP address is a “visible” address and does not benefit from the full protection of the firewall function. Therefore it is advisable that other security precautions be enabled to protect the other computers and devices on the LAN. It may be wise to use isolate the device with the DMZ IP address from the rest of the LAN. For example, if you want to use video conferencing and still use a firewall, you can use the DMZ IP address function. In this case, you must have a PC or server through which video conferencing will take place. The IP address of this PC or server will then be the DMZ IP address. You can designate the server's IP address as the DMZ by typing in the IP address in the **IP Address** space provided and then enabling its status by clicking the **Enabled** radio button and then click **Apply**. For the system that uses the DMZ IP address, you may want to manually assign an IP address to it and adjust your DHCP server addresses so that the DMZ IP address is not included in the DHCP server range. This way you avoid possible IP address problems if you reboot the DMZ system. To configure the Router's DMZ IP address, click the **Advanced** tab at the top of the screen and then the **DMZ** tab to the left.

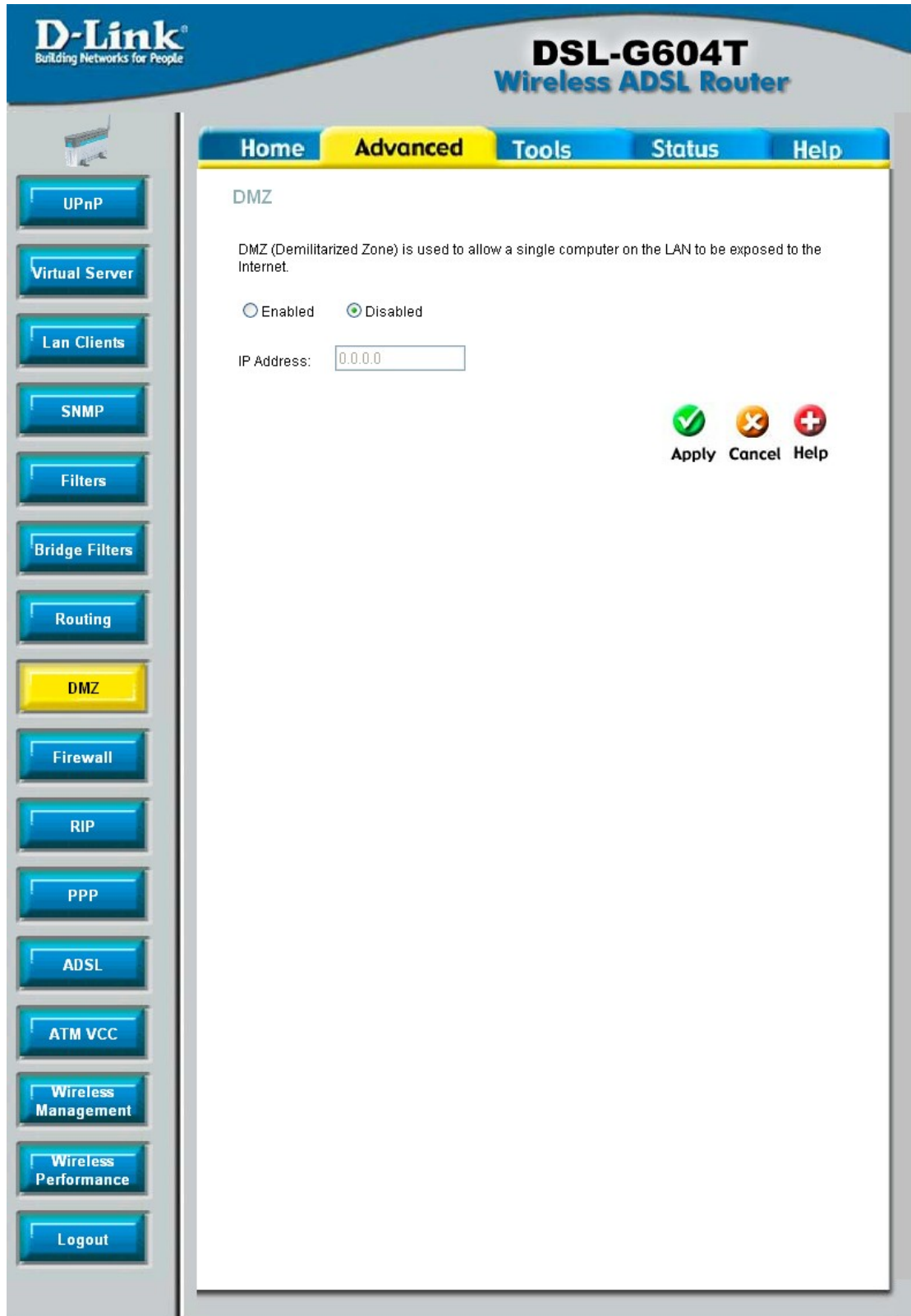

Figure 5- . DMZ window

Click **Apply** when your configuration is complete.

## **Firewall**

The DSL-G604T ADSL Router comes equipped with a firewall. The **Firewall** configuration screen allows the Router to enforce specific predefined policies intended to protect against certain common types of attacks. To configure the Router's firewall, click the **Advanced** tab at the top of the screen and then the **Firewall** tab to the left.

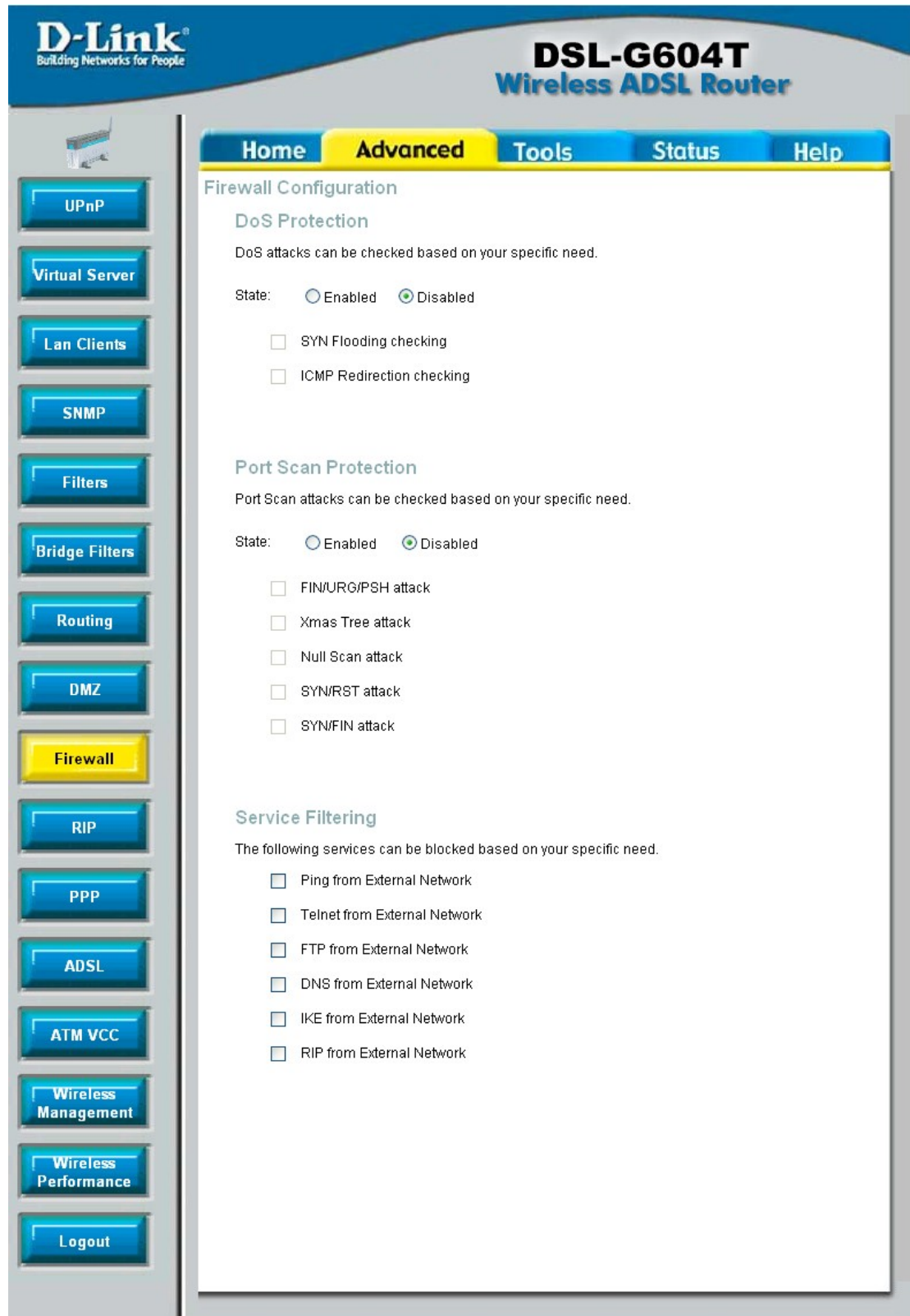

Figure 5- . Firewall window

This window has three filtering options for you to choose, **DoS (Denial of Service) Protection**, **Port Scan Protection** and **Service Filtering**. **DoS Protection** and **Port Scan Protection** may be globally enabled on the router and then may be modified to the users preference by checking the boxes in these sections. For **Service Filtering**, the user must choose which services to be filtered by the router using

the corresponding check boxes. The user may choose any combination of these to use for firewalling. Click **Apply** to set these firewall rules to the routers memory.



## **RIP**

The DSL-G604T supports RIP v1 and RIP v2 used to share routing tables with other Layer 3 routing devices on the LAN, at your ISP's location or remote networks connected to your network through the ADSL line. The user may enable or disable RIP v1 (received and sent) or RIP v2. This will enable the router to send and receive RIP packets. Disabling the RIP function will disable the routing function of this device.

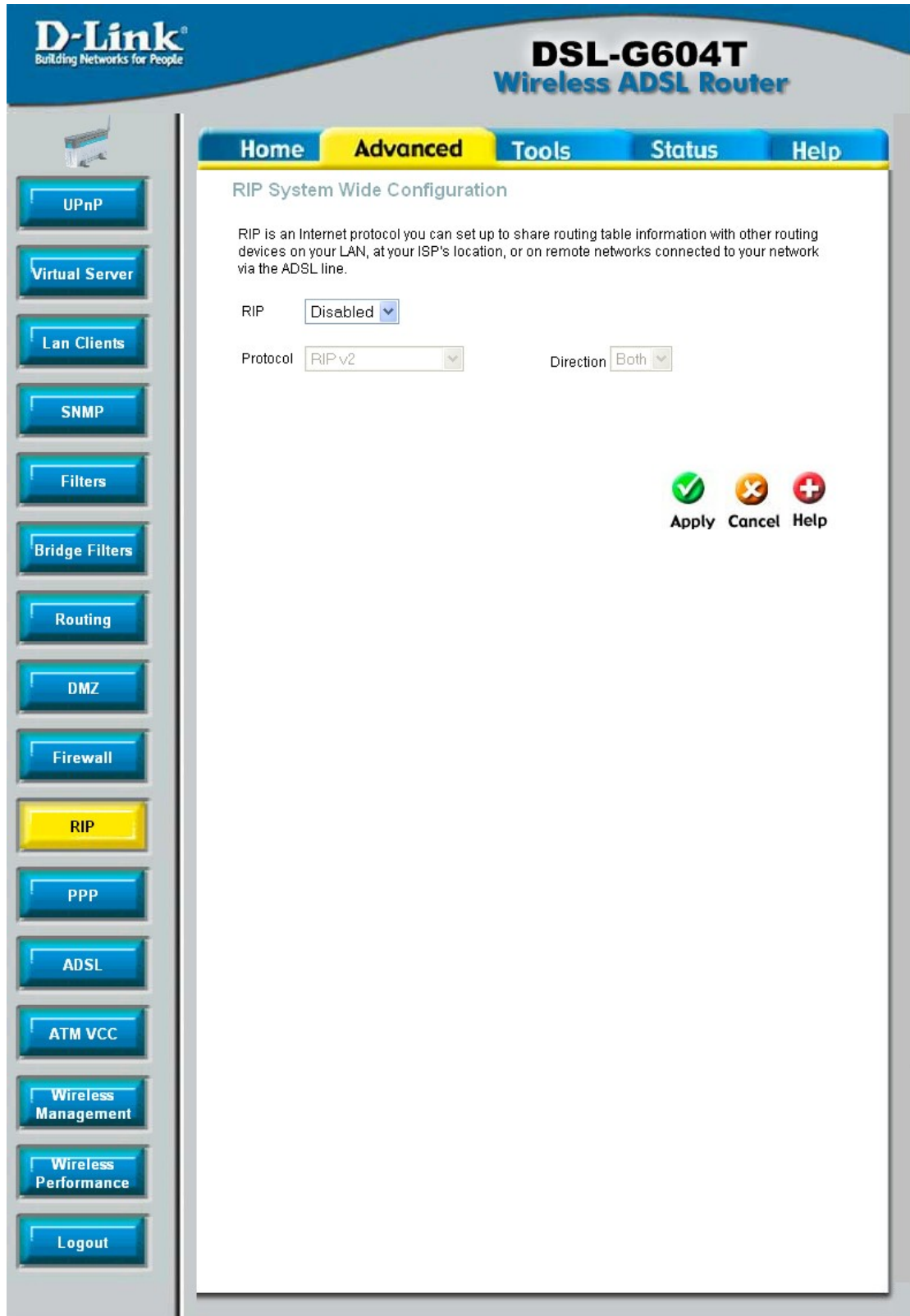

Figure 5- . RIP window

To configure RIP, first use the RIP pull-down menu to enable RIP on the Router. Then select the protocol to be used by using the pull-down menu. The choices are **RIP v1**, **RIPv1 Compatible** and **RIP v2**. Then the user must choose the direction by selecting **In**, **Out** or **Both**. After making the configuration choices for RIP, click the **Apply** button to set the configurations in the memory of the Router.

## **PPP**

The following window is for users employing the PPP protocol as their connection to the ISP. This window will be specific to PVCs previously configured and will display information concerning the PVC selected in the WAN configuration window.

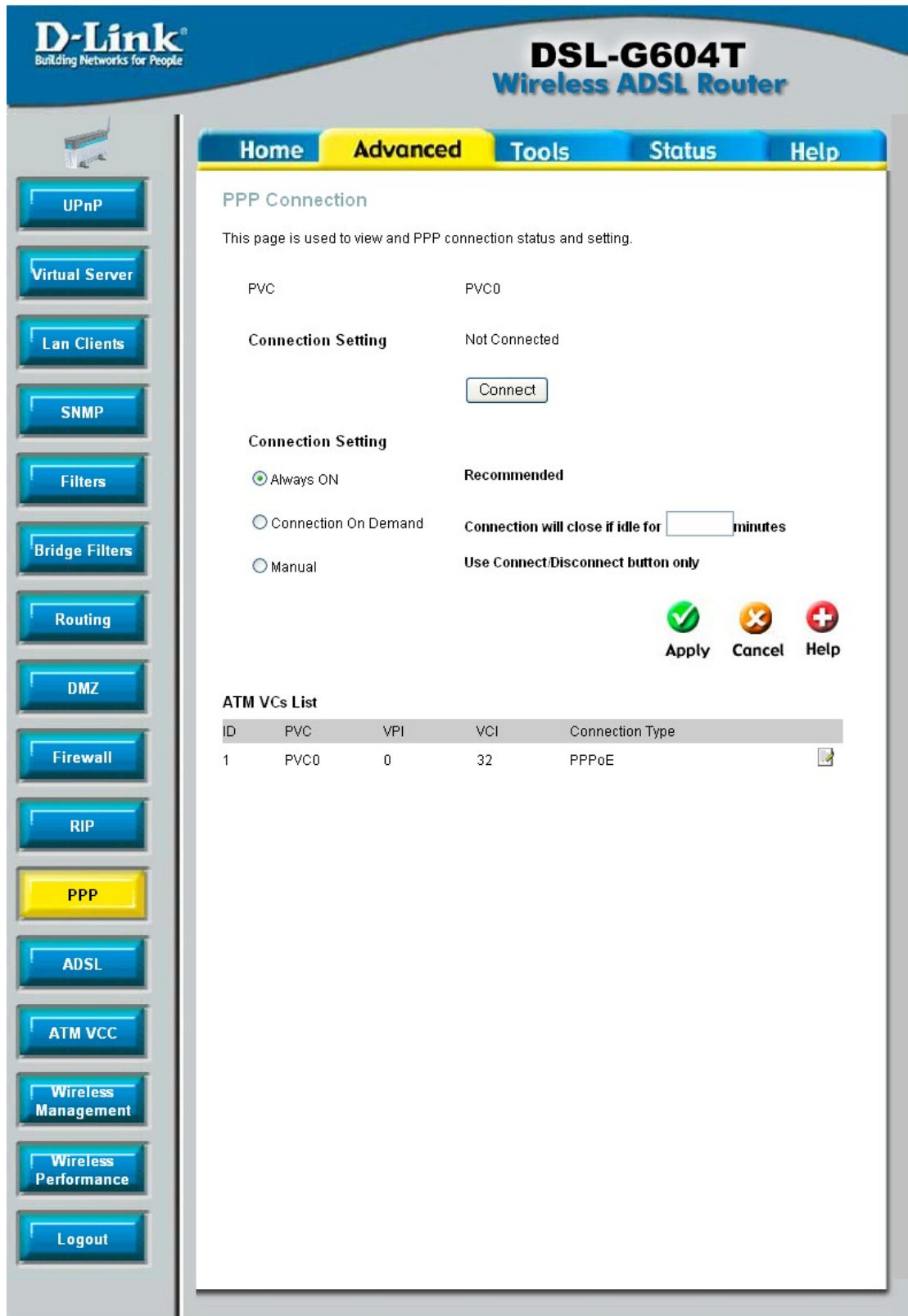

Figure 5- . PPP window

The window above displays the following information.

<b>PVC</b>	Displays the PVC currently in use on the Router. This router can be configured for eight PVCs.
<b>Connection Setting</b>	This field has three options for the connection setting of the PPP protocol.

	<ul style="list-style-type: none"><li>• <b>Always On</b> – Clicking this radio button will set the connection to always be connected.</li><li>• <b>Connection on Demand</b> – Clicking this radio button will set the Router to connect to the Internet only when requested to by your computer.</li><li>• <b>Manual</b> – Clicking this radio button will set the router to only connect when the user clicks the connect button in the previous field.</li></ul>
<b>ATM VCs List</b>	This field will display the status of PVCs currently in use on the Router.

Click **Apply** to set the changes in the memory of the Router.

## **ADSL**

This window will allow you to set the ADSL configuration protocol for the ADSL Router. You may choose the modulation type from the pull-down window. The options are **Multi-mode**, **T1.413**, **G.Dmt** and **G.lite**. Your ISP must provide this information to you. Click **Apply** after you have made the proper selection.

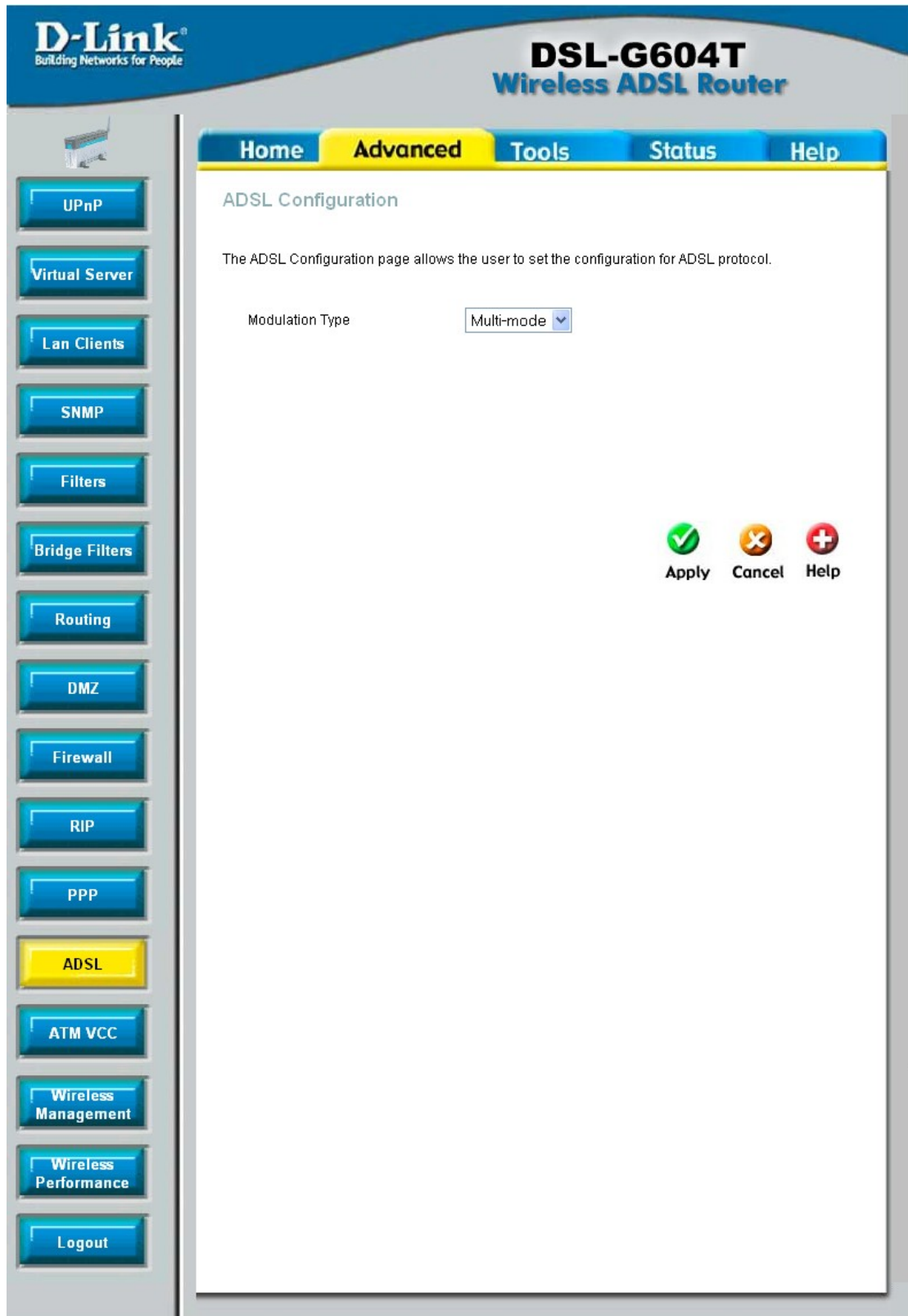

Figure 5- . ADSL window

## ATM VCC

The ATM VCC window shows you the current WAN settings implemented on your ADSL Router under the heading ATM VCs List at the bottom of the screen. Selecting a Connection Type will

change the window for the values for the Connection setting selected. These values have already been described in the WAN section of the Home setup. Click **Apply** to set changes into the Router's memory.

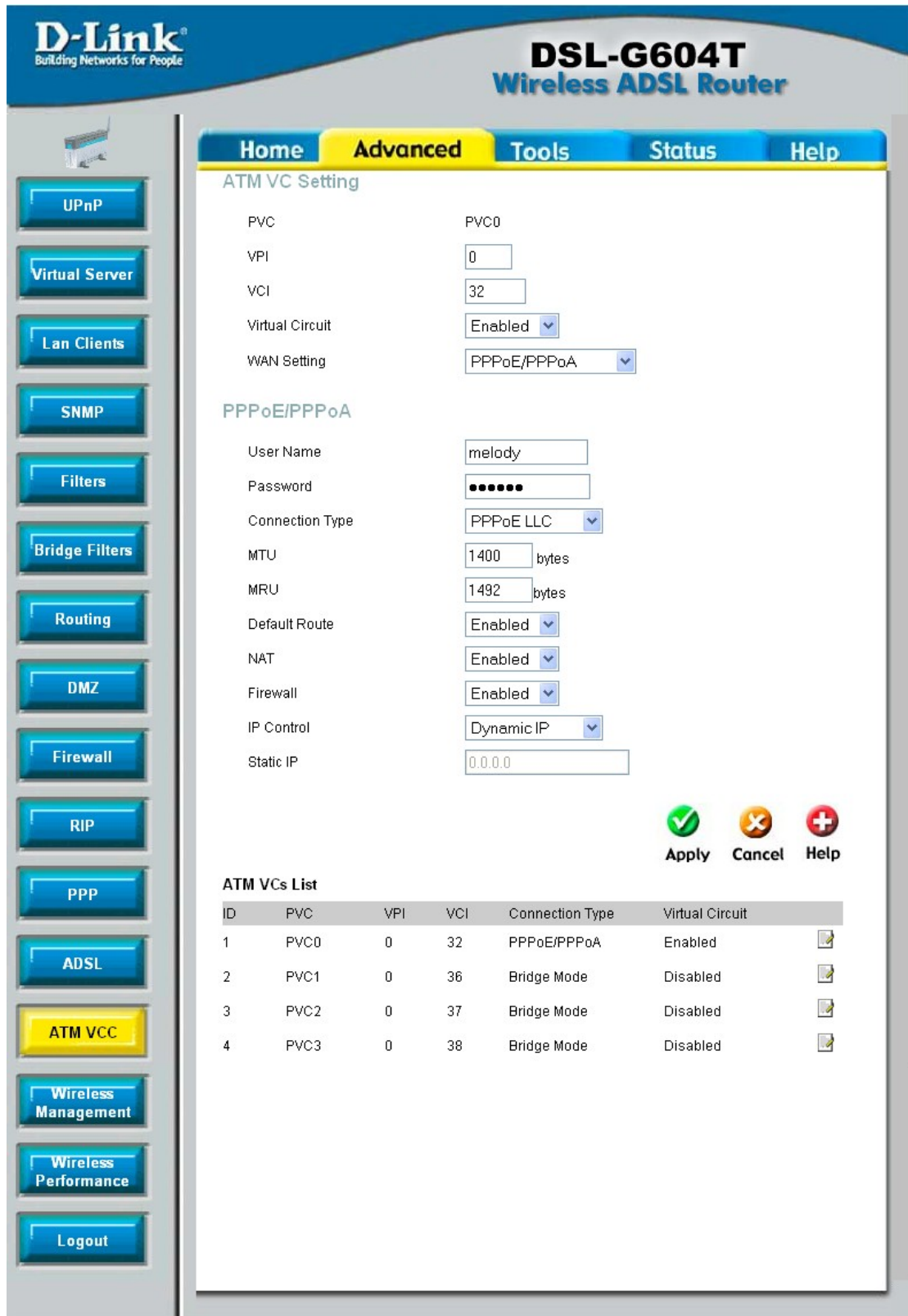

Figure 5- . ATM VCC window

## **Wireless Management**

The **Wireless Management** menu located in the **Advanced** directory is used to control MAC address access to the wireless access point and to view a list of MAC addresses that are currently associated with the access point. This menu is also be used to enable and configure use of multiple SSIDs. To use more than one SSID, WEP and WPA security must first be disabled (see below).



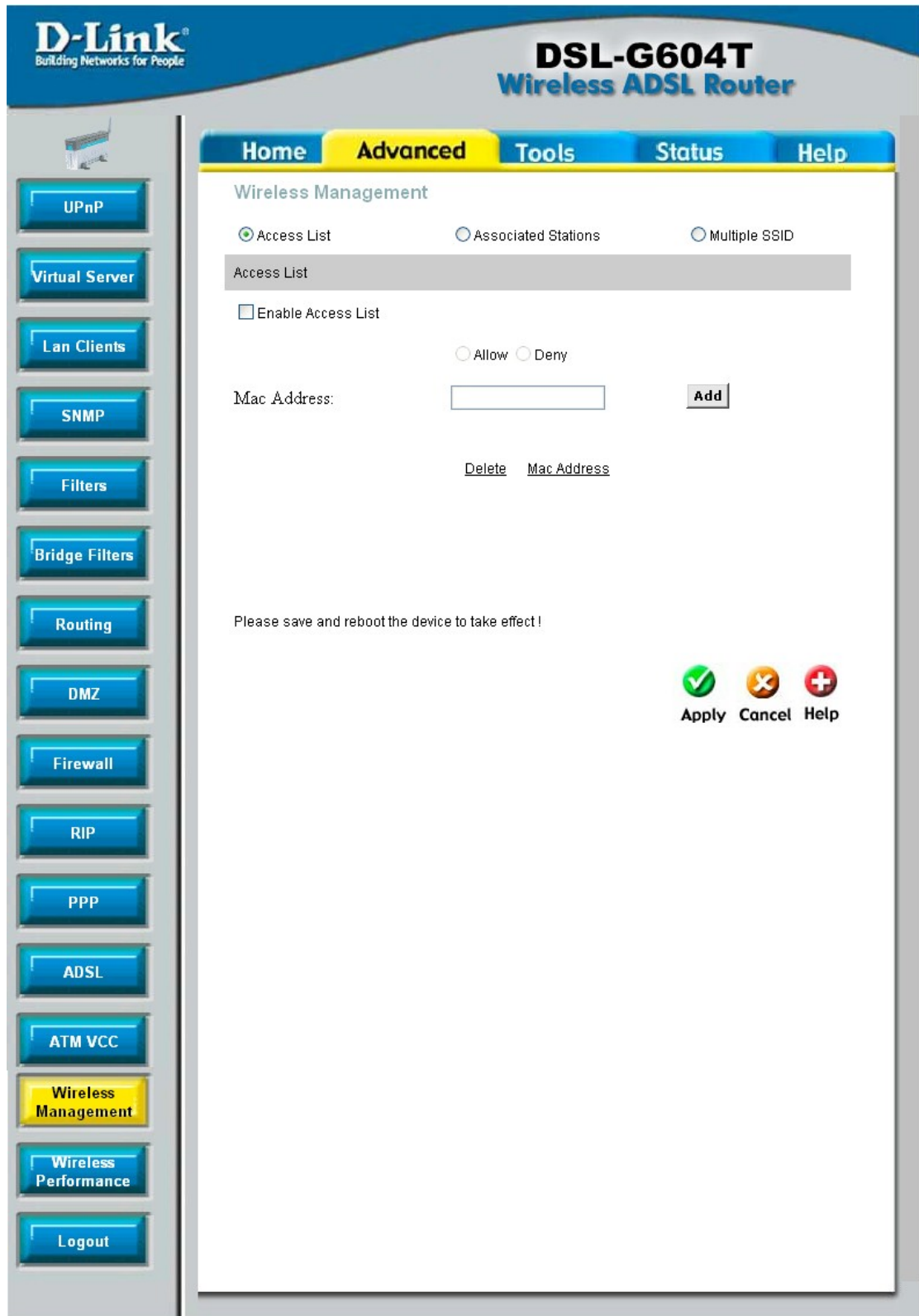

Figure 5- . Wireless Management

### Configure Wireless Access Control

To create a list of MAC addresses that are banned or allowed association with the wireless access point:

1. Click in the **Enable Access List** option box to select it.

2. Select the action to perform on the MAC address to be specified. Choose to **Allow** or Deny association.
3. Type in the **MAC Address** in the entry field provided.
4. Click the **Add** button to add the MAC address to the list. The MAC address will appear listed in the table below.
5. After compiling the list of MAC addresses as desired, click the **Apply** button to enforce access control for the MAC addresses in the list.

To remove any MAC address from the list, click the radio button in the left column of the list for the MAC address to be removed and click the **Apply** button. To view a list of stations currently associated with the access point, click the **Associated Stations** radio button.

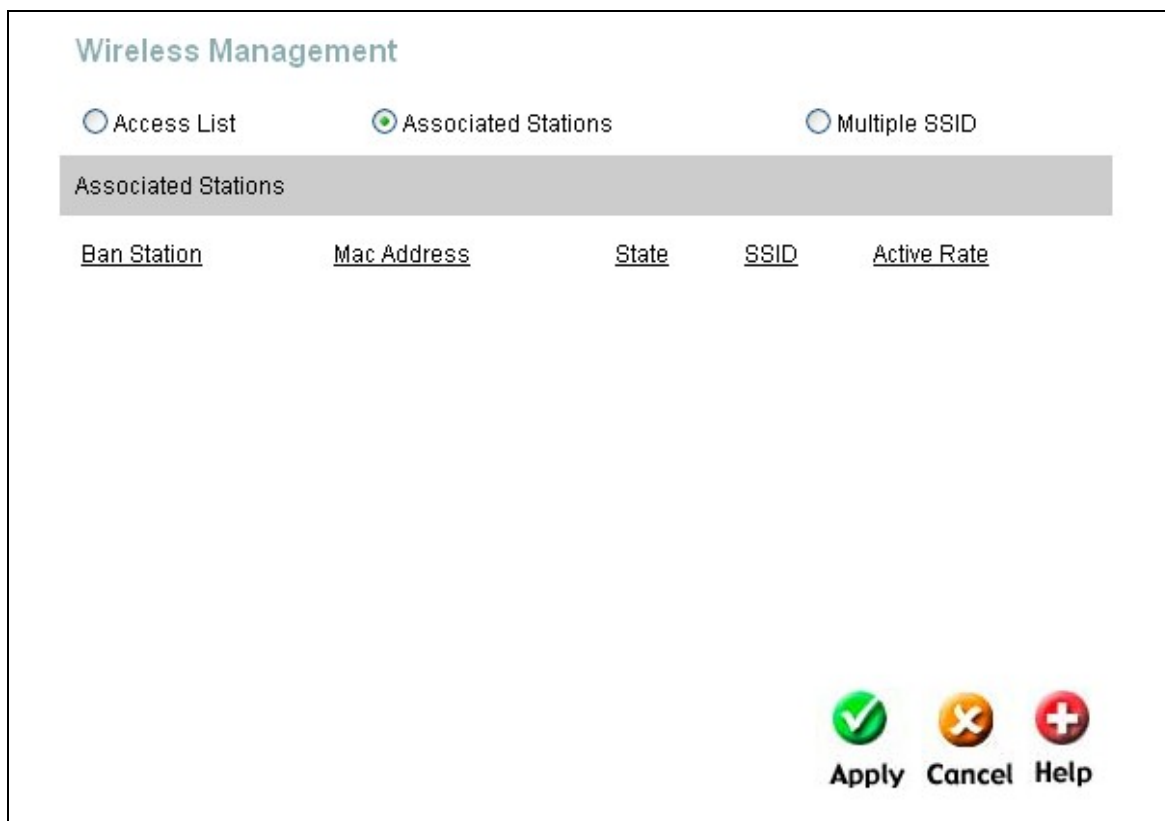

Figure 5- . Wireless Management –Associated Stations window

### Configure Multiple SSID

Multiple SSID cannot be used if the access point has either WPE or WPA enabled. This must first be disabled in the Wireless menu located in the Home directory.

To configure multiple SSID:

1. Disable WEP or WPA in the **Wireless** menu of the **Home** directory.
2. Click in the **Enable Multiple SSID** option box to select it.
3. Enter the **SSID** you want to add.
4. Click the **Add** button to add the SSID to the list.
5. Click the **Apply** button to enable the listed SSIDs.

To remove an SSID from the list, click the radio button in the left column of the list for the SSID to be removed and click the **Apply** button.

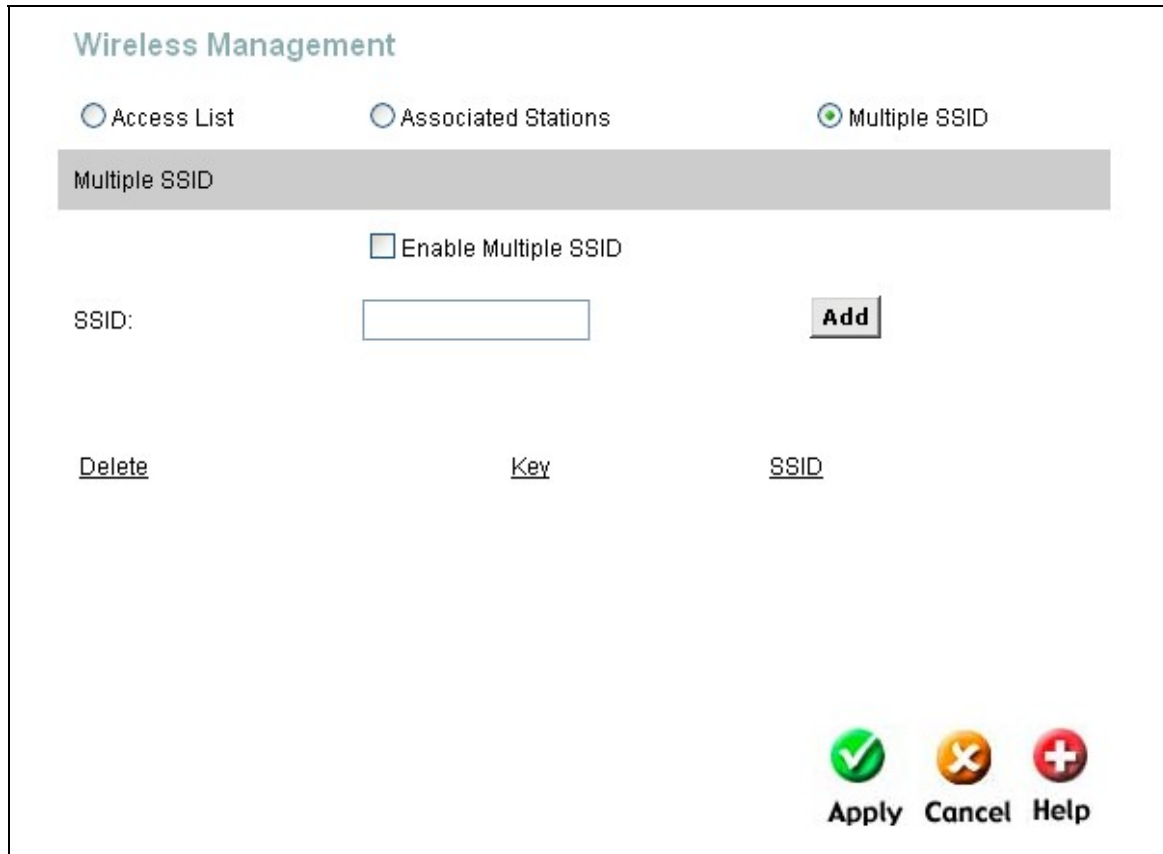

Figure 5- . Wireless Management –Multiple SSID window

## Wireless Performance

If you want to change the wireless settings, click the **Wireless Performance** menu button in the **Advanced** directory



**Note**

*It is recommended for most users to use the default Wireless LAN Performance settings. Any changes made to these settings may adversely affect your wireless network. Under certain circumstances, changes may benefit performance. Carefully consider and evaluate any changes to these wireless settings.*

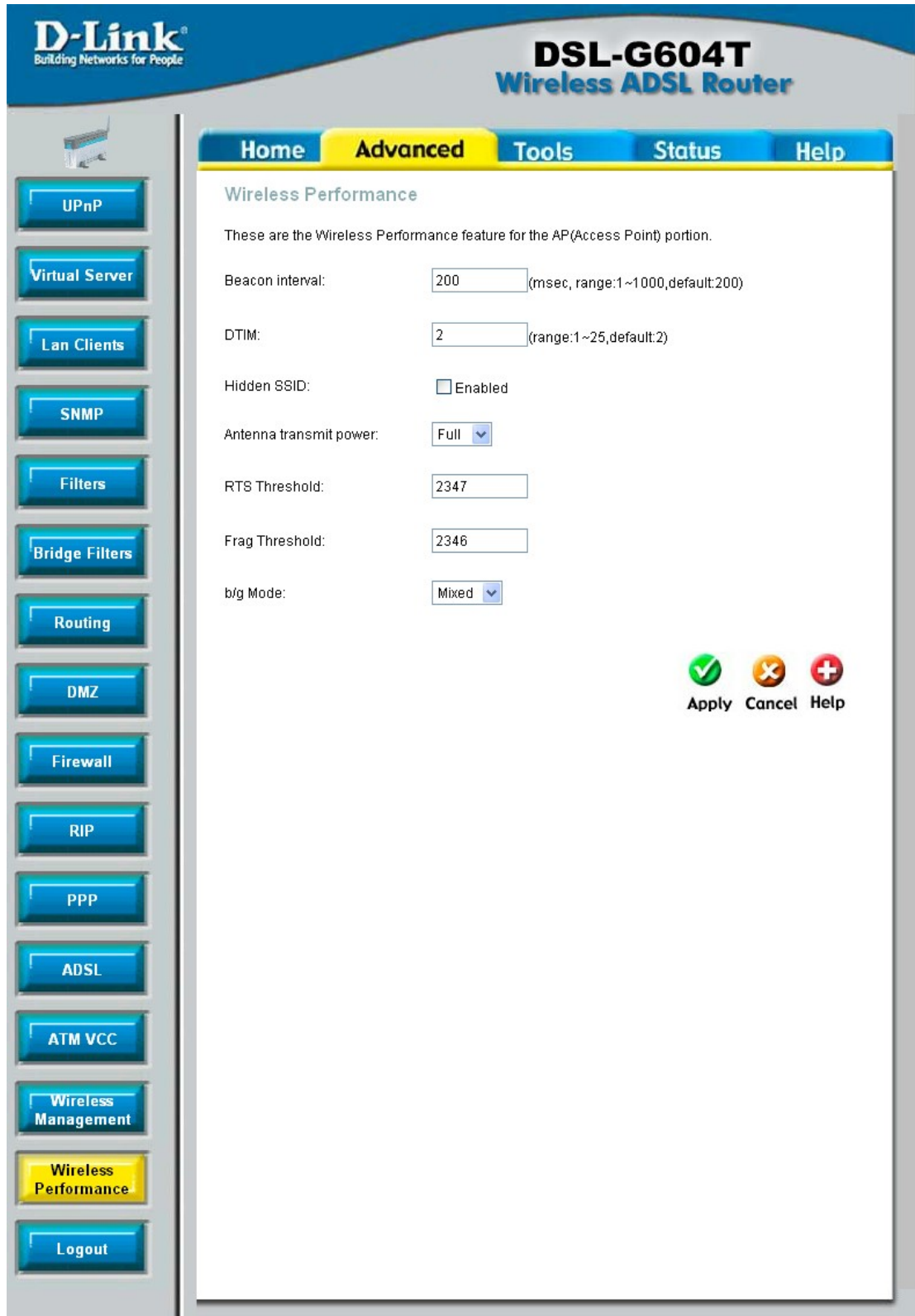

Figure 5- . Wireless Performance window

## Tools

The Tools tab allows you to set up basic maintenance features on the ADSL router. The windows available under this tab include **Admin**, **Time**, **Remote Log**, **System**, **Firmware**, **Micellaneous**, and **Test**.

### Admin

The **Admin** window allows you to configure a new password for the ADSL Router. There is only one administrator account that can access the DSL-G604T's web management interface. To change the password enter the new password into the **New Password** field and repeat the password in the **Confirm Password** field. To change the Router's port number use the **Web Port** field. Click **Apply** to set your new password. This window will also allow the user to enable remote management of the device from a remote computer, either through the web management or through Telnet. To configure this function, click the **Enabled** radio button under the **Remote Management** heading, enter the **IP Address** of the computer you wish to allow to remotely configure the Router, along with the corresponding SubnetMask (**Netmask**). Click **Apply** to set these configurations into the memory of the Router.

**D-Link**  
Building Networks for People

# DSL-G604T Wireless ADSL Router

Home Advanced **Tools** Status Help

## Administrator Settings

There is only one account that can access the DSL-G604T's Web-Management interface.

Administrator (The Login Name is "admin")

New Password

Confirm Password

WebPort  (Change the port number of login web)

## Remote Web Management

State  Enabled  Disabled

IP Address

Netmask

## Remote Telnet Management

State  Enabled  Disabled

IP Address

Netmask

Apply Cancel Help

Figure 6- . Administrator Settings window

## Time

The system time is the time used by the DSL-G604T for scheduling services. You can manually set the time, connect to a NTP (Network Time Protocol) server or synchronize the time on the router with your PC. If an NTP server is set, you will only need to set the time zone (in the set up wizard). You may also set the time from the clock on your computer by checking the corresponding radio button. To manually set the time, you will need to input the value into the fields provided. Click **Apply** to set changes.

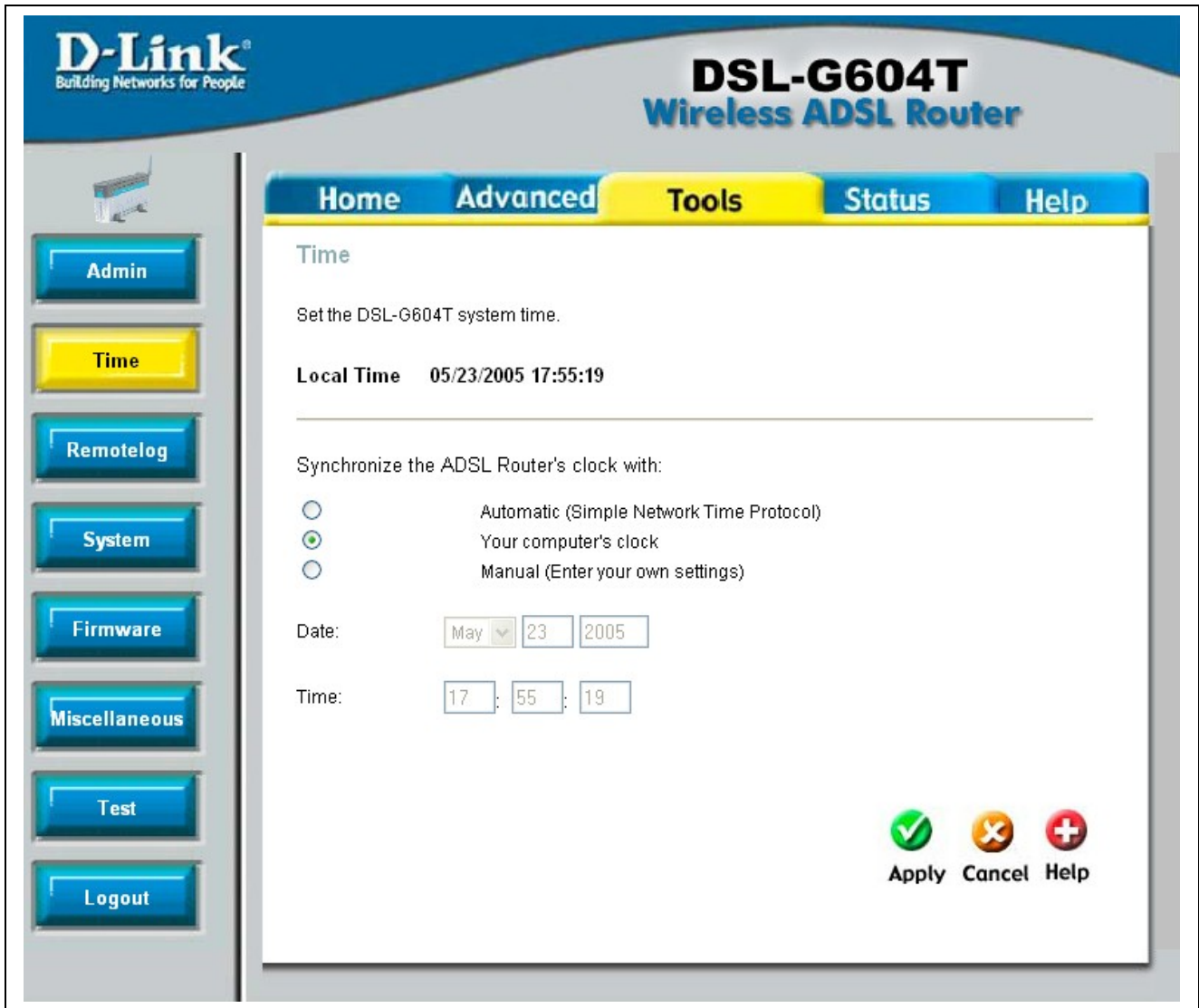

Figure 6- . Time window

## Remote Log

Use the Remote Log menu to set up logging to servers or computers that are located outside the LAN or subnet of the Router.

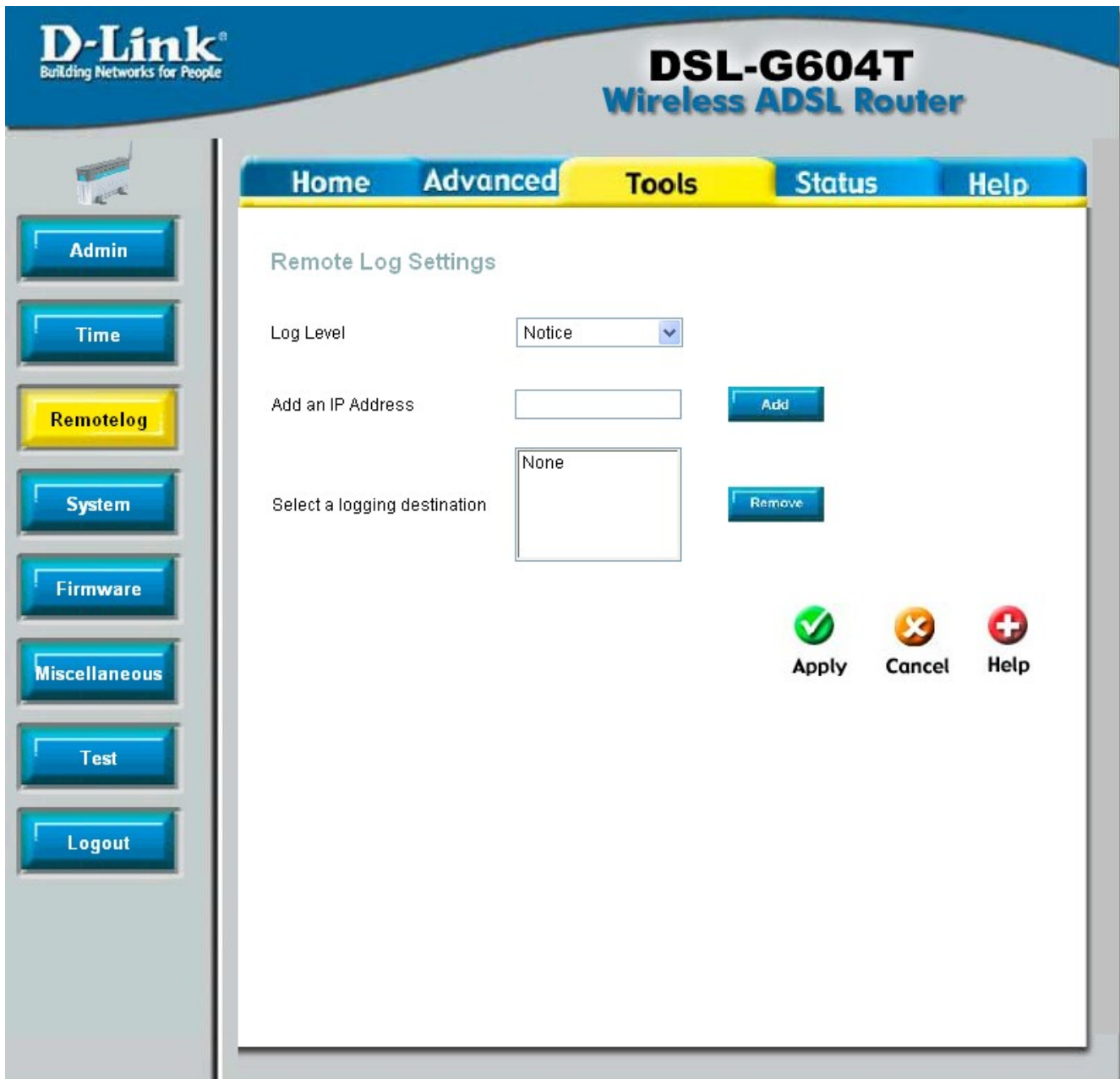

Figure 6- . Remote Log window

Select the **Log Level** from the pull-down menu. The levels available are: *Alert*, *Critical*, *Debug*, *Error*, *Info*, *Notice*, *Panic* and *Warning*. Type in the IP address of a receiver for the log message in the **Add an IP Address** field and click on the **Add** button. Log message receivers that are added appear listed in the **Select a logging destination** pull-down menu. These may be used at any time for other types of log messages. To remove a log message receiver from the list, select it and click on the **Remove** button. Click the **Apply** button when you have configured the log message receivers. Remember to save the settings to non-volatile memory.



## System

This window offers four settings for the user to configure. The user may save the settings configured on the router by clicking the Save button. A file Download dialogue box will appear questioning the user where to save the files on your computer. Files will be saved as XML documents. The user may also upload save settings by using the **Load Settings from Local Hard Drive** field by entering the path of the file on your computer into the box. If you are not sure of the path, click **Browse** to find the file on your computer. Click **Load** to initiate the file transfer. Next, click save and reboot. You may reset the ADSL Router back to factory default settings by clicking on **Restore**. To force the Router to Restart, click **Restart AP**.



Figure 6- . System Settings window

## Firmware

You can upgrade the firmware of the ADSL Router at this page. Make sure the firmware you want to use is on the local hard drive of the computer. Click on **Browse** to browse the local hard driver and locate the firmware to be used for the update. Once found, click **Apply** to initiate the transfer. Please check the D-Link support site for firmware updates at D-Link Technical support website of your country. Remember to restart the Router after uploading new firmware.

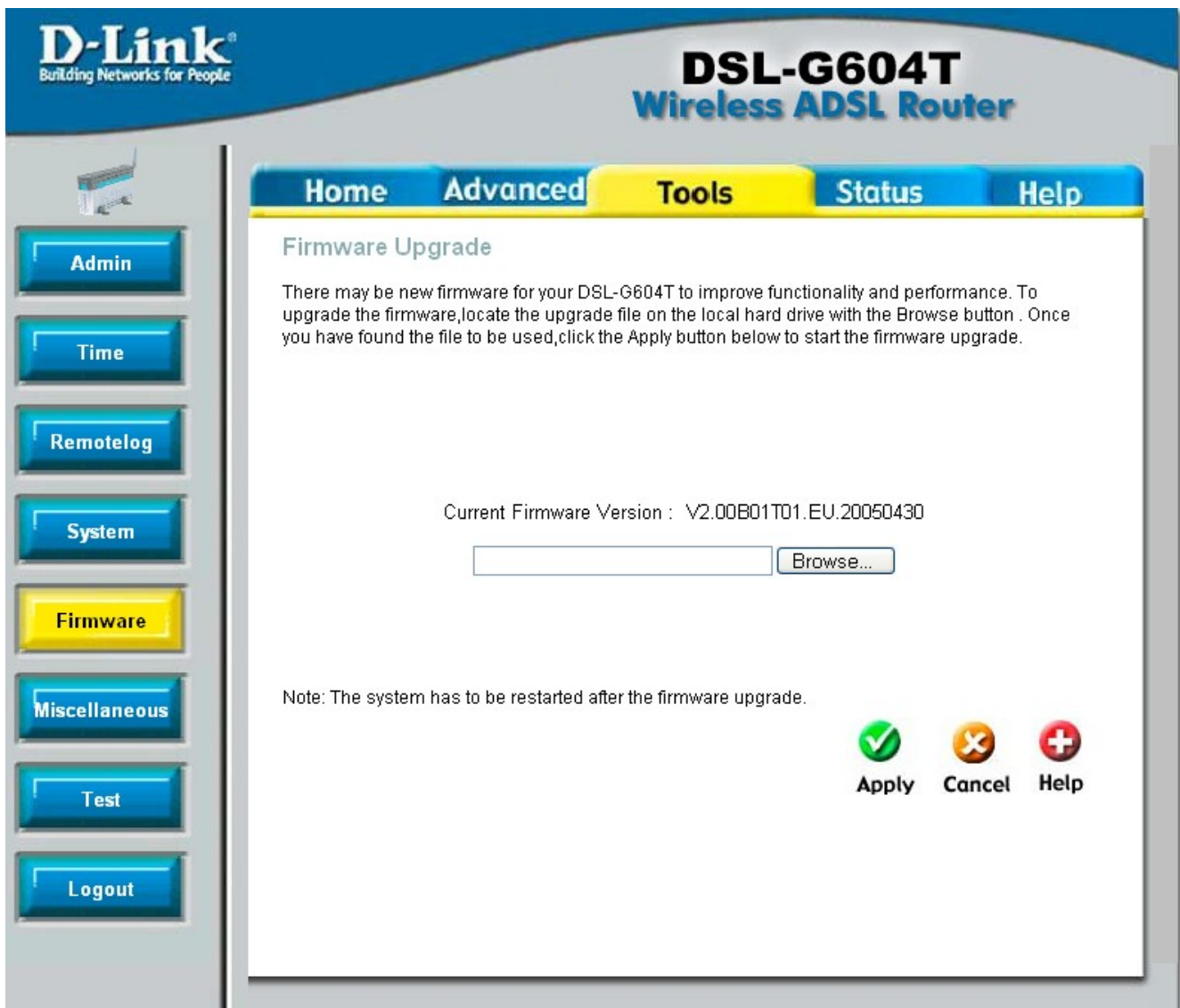

Figure 6- . Firmware Upgrade window

## Miscellaneous

The **Ping Test** menu allows you to ping any IP address from the Router to test connectivity to the address. To Ping a device, enter the IP address of the device that you wish to ping into the **Ping IP Address** field and click **Ping** to start the Ping mechanism. The results of the ping will be shown under the **Ping Result** heading. The Miscellaneous Configuration menu also allows you to enable IGMP forwarding. This is **Disabled** by default. This setting will not allow IGMP (Internet Group Management Protocol) packets to be forwarded to the LAN. IGMP is used to manage multicasting on TCP/IP networks, most users will not need to enable this. Some ISPs use IGMP to perform remote configuration for client devices, such as the Router. If you are unsure, check with your ISP. To enable IGMP service to the LAN interface, select **Enabled** and click the **Apply** button. To force a system restart click **Save and Reboot**.

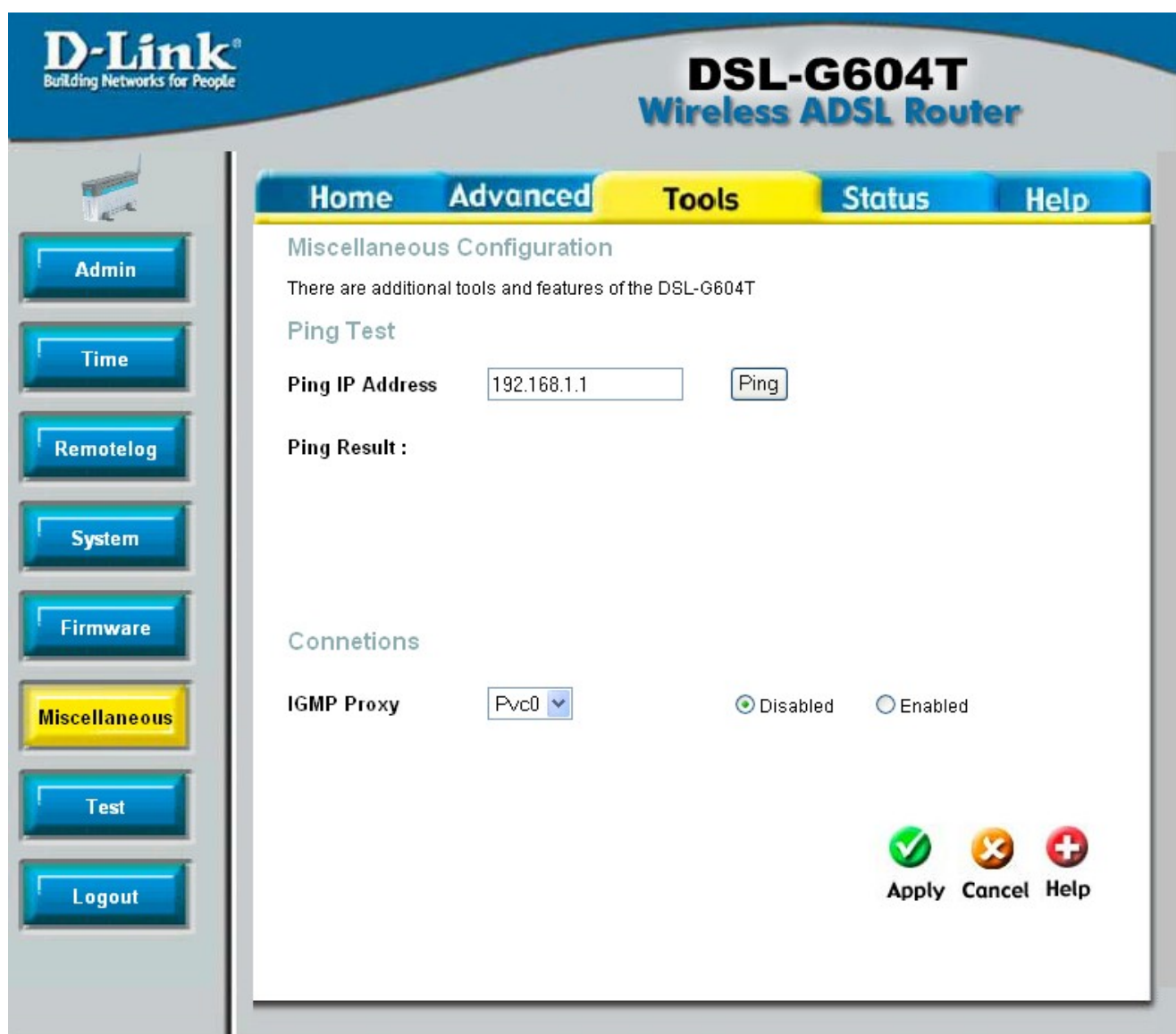

Figure 6- . Miscellaneous window

## Test

The **Diagnostics** window allows users to test the functionality of the router by executing a series of tests. This window will aid the user in troubleshooting various problems that may occur with the functionality of the router. This window will appear differently depending on connection type chosen. The following picture shows the window that includes all possible connection tests associated with this Router.

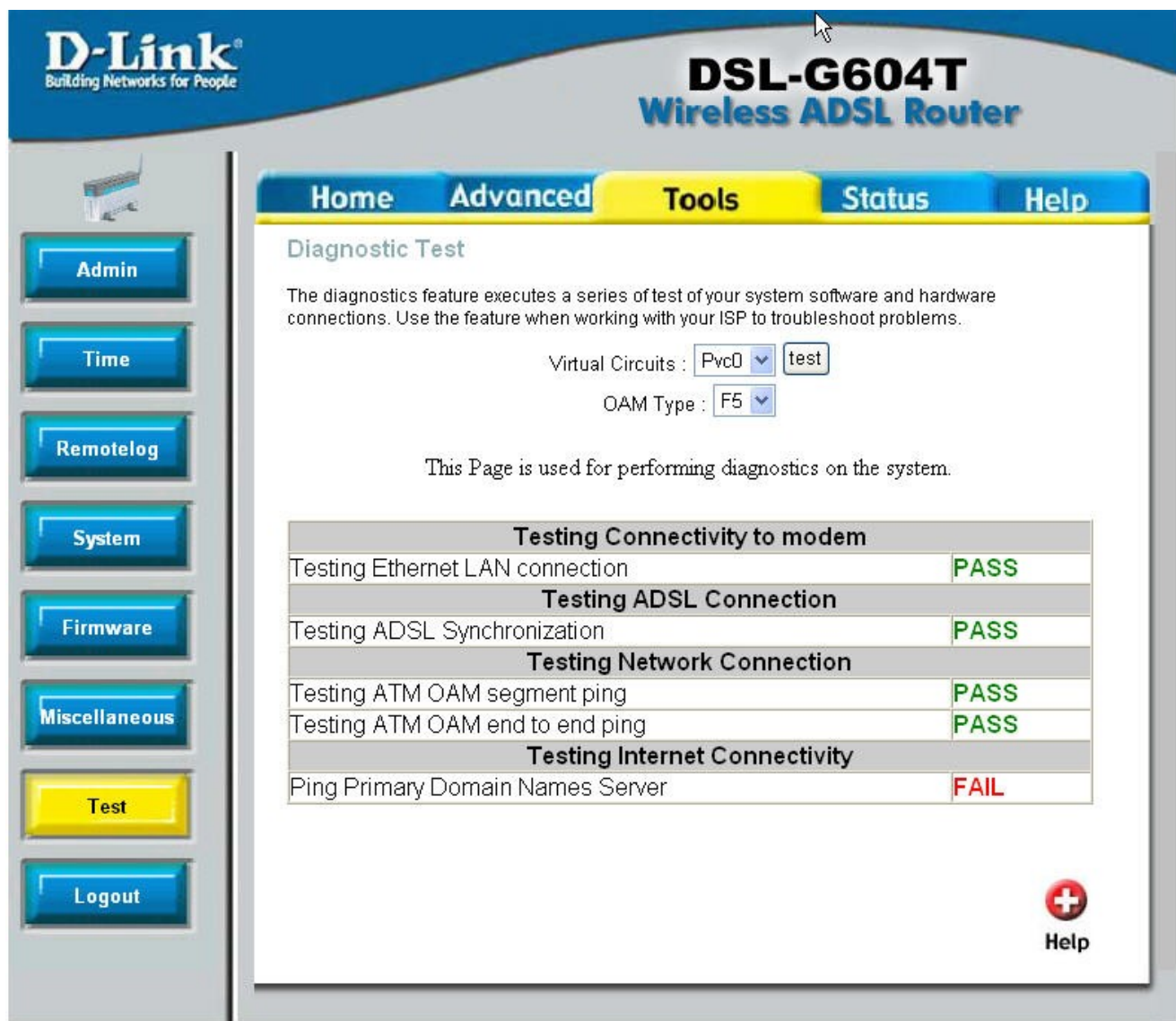

Figure 6- . Diagnostics window

To perform the following tests, choose the **PVC0** (Private Virtual Connection) and click **Apply**. Test results will either be displayed as **Pass** or **Fail**. The following tasks will be performed:

<b>Testing Ethernet LAN Connection</b>	This test will check the Ethernet connection of your Router.
<b>Testing ADSL Synchronization</b>	This test will check the ADSL line connected to your Router.
<b>Testing ATM OAM segment ping</b>	This test will check the PVC connectivity by sending out an OAM (Operation Administration Management) packet. If the remote device on this segment returns the ping packet, the PVC has passed the test

	and a Pass result will appear.
<b>Testing ATM OAM end to end ping</b>	This test will check the PVC connectivity by sending out an OAM (Operation Administration Management) packet. If the remote device returns the ping packet, the PVC has passed the test and a Pass result will appear.
<b>Ping Primary Domain Name Server</b>	This test will check to see if the Primary DNS is accessible from the Router.

## Status

The **Status** tab will allow users to check information about the Router, including **Device Information**, **DHCP Clients**, **Log**, **Statistics** and **ADSL**.

### Device Info

The device info window, located under the **Status** tab will allow users to view information regarding the settings of the Router, both on the LAN side and WAN side of the connection.

The screenshot displays the web interface for the D-Link DSL-G604T Wireless ADSL Router. The top navigation bar includes tabs for Home, Advanced, Tools, Status (selected), and Help. A left sidebar contains buttons for Device Info, DHCP Clients, Log, Statistics, ADSL, and Logout. The main content area shows the 'Device Information' window with the following details:

Firmware Version : V2.00B01T01.EU.20050430

LAN	
MAC Address	00:0d:08:00:03:02
IP Address	192.168.1.1
Subnet Mask	255.255.255.0
DHCP Server	Enabled
NAT	Enabled

WAN	
Virtual Circuit	Pvc0
Status	Not Connected
Connection Type	pppoe
IP Address	N/A
Subnet Mask	N/A
Default Gateway	N/A
DNS Server	N/A

A red cross icon labeled 'Help' is located in the bottom right corner of the Device Information window.

Figure 7- . Device Info window

The following information is what is displayed in the **Device Info** window:

LAN	
<b>MAC Address</b>	Displays the MAC Address of the Router.
<b>IP Address</b>	Displays the current IP address of the Device.
<b>Subnet Mask</b>	Displays the Subnet Mask of the device.
<b>DHCP Server</b>	Displays the DHCP status implemented on the Router.
<b>NAT</b>	Displays the current NAT status implemented on the Router.
WAN Channel	
<b>Virtual Circuit</b>	Displays the number of the Private Virtual Channel located on the Router.
<b>Status</b>	Displays the connection status of the selected Virtual Channel.
<b>Connection Type</b>	Displays the connection type employed on this Virtual Circuit.
<b>IP Address</b>	Displays the IP address of the corresponding Virtual Circuit.
<b>Subnet Mask</b>	Displays the Subnet mask of the corresponding Virtual Circuit.
<b>Default gateway</b>	Displays the Default gateway of the corresponding Virtual Circuit.
<b>DNS Server</b>	Displays the DNS Server currently employed on this Virtual Circuit.

## DHCP Clients

To view DHCP clients that are configured on the Router click **DHCP Clients** under the Status tab.

The screenshot displays the web management interface for a D-Link DSL-G604T Wireless ADSL Router. The interface features a blue header with the D-Link logo and the product name. A navigation menu at the top includes 'Home', 'Advanced', 'Tools', 'Status', and 'Help'. The 'Status' tab is currently selected. On the left side, there is a vertical menu with buttons for 'Device Info', 'DHCP Clients', 'Log', 'Statistics', 'ADSL', and 'Logout'. The main content area shows the 'DHCP Clients' window, which contains a table with the following data:

MAC Address	IP Address	Host Name
00:50:8d:36:89:48	192.168.1.2	unknown
00:0d:88:56:2c:f2	192.168.1.3	wxp2074

At the bottom right of the DHCP Clients window, there is a red circular icon with a white plus sign and the text 'Help' below it.

Figure 7- . DHCP Clients window

## Log

The **Log** window allows users to view events occurring within the Router by time and date. To clear the log events, click **Clear Log**. To save the log, click **Save Log** and a pop-up window will appear to find a folder on your computer to save the log files to.



The screenshot shows the web interface of a D-Link DSL-G604T Wireless ADSL Router. The top navigation bar includes 'Home', 'Advanced', 'Tools', 'Status' (highlighted), and 'Help'. On the left sidebar, there are buttons for 'Device Info', 'DHCP Clients', 'Log' (highlighted), 'Statistics', 'ADSL', and 'Logout'. The main content area is titled 'View Log' and contains a description: 'View Log displays the activities occurring on the DSL-G604T.' Below this are navigation buttons: 'First Page', 'Last Page', 'Previous', 'Next', 'Clear Log', and 'Save Log'. A 'Help' icon is also present. The log content shows a timestamp 'page 1 of 2' and a table with two columns: 'Time' and 'Message'. The log entries describe the router's boot process, including CPU halt, FW image loading, and various system components coming online.

**View Log**  
View Log displays the activities occurring on the DSL-G604T.

First Page Last Page Previous Next Clear Log Save Log

Help

page 1 of 2

Time	Message
Sep 8 12:00:21>	what_acxProcInitiate: Cpu halt -} download code
Sep 8 12:00:21>	what_acxProcLoadFwImage: 0xa4000000, 0x0
Sep 8 12:00:21>	what_acxProcLoadFwImage() -- Loading FW image182: Compiled for RADIA (bg) radio
Sep 8 12:00:21>	what_acxProcLoadFwImage: 1, pBuf=0xc00a2000, len=0x15564, Extra pBuf=0x0, len=0x3
Sep 8 12:00:21>	what_acxProcLoadFwImage: 2, pBuf=0xc00a2000, len=0x15564, Extra pBuf=0x0, len=0x3
Sep 8 12:00:21>	what_acxProcLoadFwImage: 3, pBuf=0xc00a2000, len=0x15564, DataLen=0x1556c
Sep 8 12:00:21>	what_acxProcLoadFwImage: 4, pBuf=0xc00a2000, len=0x15564
Sep 8 12:00:21>	what_acxProcLoadFwImage: Checksum, calc=0x71e76f, file=0x71e76f
Sep 8 12:00:21>	BssBridge is up
Sep 8 12:00:21>	Mgmt is up
Sep 8 12:00:21>	Rx is up
Sep 8 12:00:21>	Tx is up
Sep 8 12:00:21>	MemMgr is up
Sep 8 12:00:21>	main state machine is up
Sep 8 12:00:21>	WDRV_MAINSM: WLAN Driver initialized successfully
Sep 8 12:00:21>	
Sep 8 12:00:21>	WDRV_4X: 4x Disabled
Sep 8 12:00:21>	WDRV_4X: Concatenation Disabled
Sep 8 12:00:21>	WDRV_4X: Ack Emulation Disabled
Sep 8 12:00:21>	what_apiStartBss: Enable Tx, Rx and Start the Bss

Figure 7- . Device Log window

## Statistics

The Stats window will allow users to view transmitted and received packets occurring on the Router for Ethernet ADSL, and Wireless connections. To choose a interface to view statistics for, click the corresponding radio button for **ADSL**, **Ethernet**, or **Wireless**. This will change the **Statistics** screen, as shown below. To refresh the stats in this window, click **Refresh**.

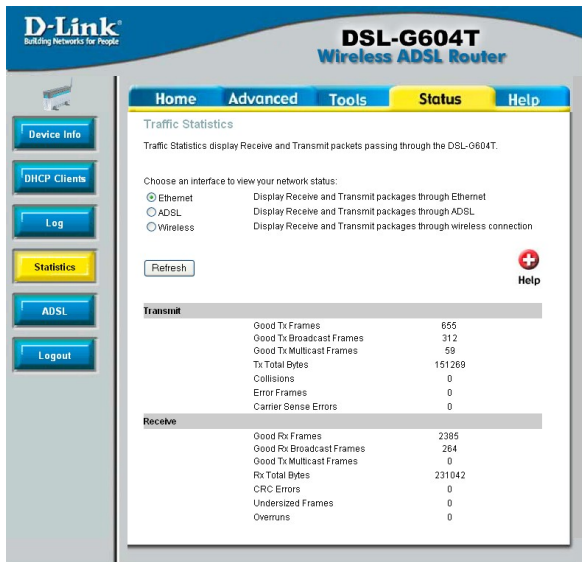

Figure 7- . Stats window for Ethernet

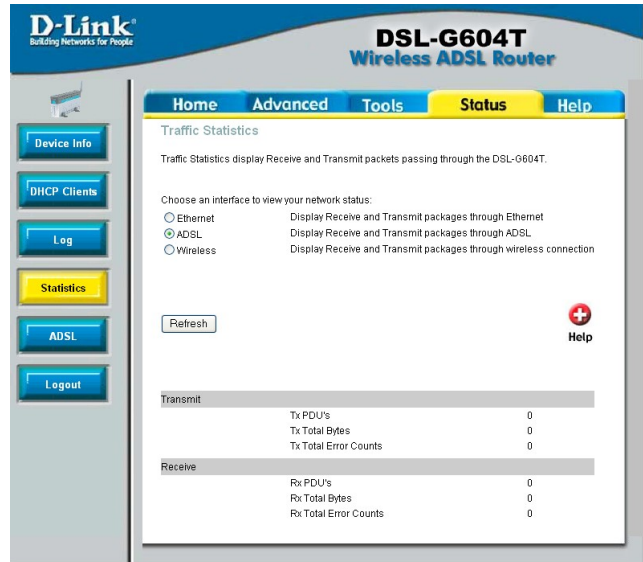

Figure 7- . Statistics window for ADSL

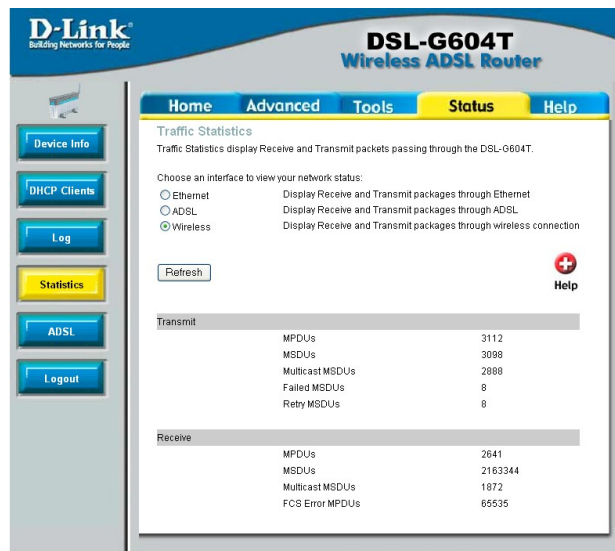

Figure 7- . Statistics window for Wireless

## ADSL

The ADSL Line window, located under the **Status** tab, will allow users to monitor the speed of the upstream and downstream packet flow of the Router.

**D-Link**  
Building Networks for People

**DSL-G604T**  
Wireless ADSL Router

Home Advanced Tools **Status** Help

ADSL Status

ADSL status shows the ADSL physical layer status.

ADSL Firmware Version: 4.03.03.00 - 3.02.00.03 - 3.02.06.00 Annex A - 01.07.02 - 0.49  
 ADSL Software Version: V2.00B01T01.EU.20050430  
 Line State: Disconnected  
 Modulation: Multi-mode  
 Annex Mode: ANNEX\_A  
 Max Tx Power: -38 dBm/Hz

Item	Downstream	Upstream	Unit
SNR Margin	0	0	dB
Line Attenuation	0	0	dB
Data Rate	0	0	kbps

Help

Figure 7- . Status ADSL window

The following information is displayed:

<b>ADSL Firmware Version</b>	The current Firmware version currently set in the Router.
<b>Line state</b>	Displays the current line state of the ADSL connection, either being <b>Up</b> or <b>Down</b> .
<b>Modulation</b>	Displays the modulation type currently set on the router for the ADSL connection.
<b>Annex mode</b>	This field displays the ADSL annex modes for Annex A or Annex B.
<b>Max Tx Power</b>	This field displays the transmit output power level of the CPE.
<b>SNR Margin</b>	Amount of increased noise that can be tolerated while maintaining the designed BER (bit error rate). The SNR Margin is set by the Central Office DSLAM. If the

	SNR Margin is increased, bit error rate performance will improve, but the data rate will decrease. Conversely, if the SNR Margin is decreased, bit error rate performance will decrease, but the data rate will increase.
<b>Line Attenuation</b>	Attenuation is the decrease in magnitude of the ADSL line signal between the transmitter (Central Office DSLAM) and the receiver (Client ADSL Modem), measured in dB. It is measured by calculating the difference in dB between the signal power level received at the Client ADSL router and the reference signal power level transmitted from the Central Office DSLAM.
<b>Data Rate</b>	This field displays the ADSL data rate.

## Help

The **Help** tab will give basic information referring to various screens located in the Router. To view a specific section, click on its hyperlinked name. A new window of information will appear.

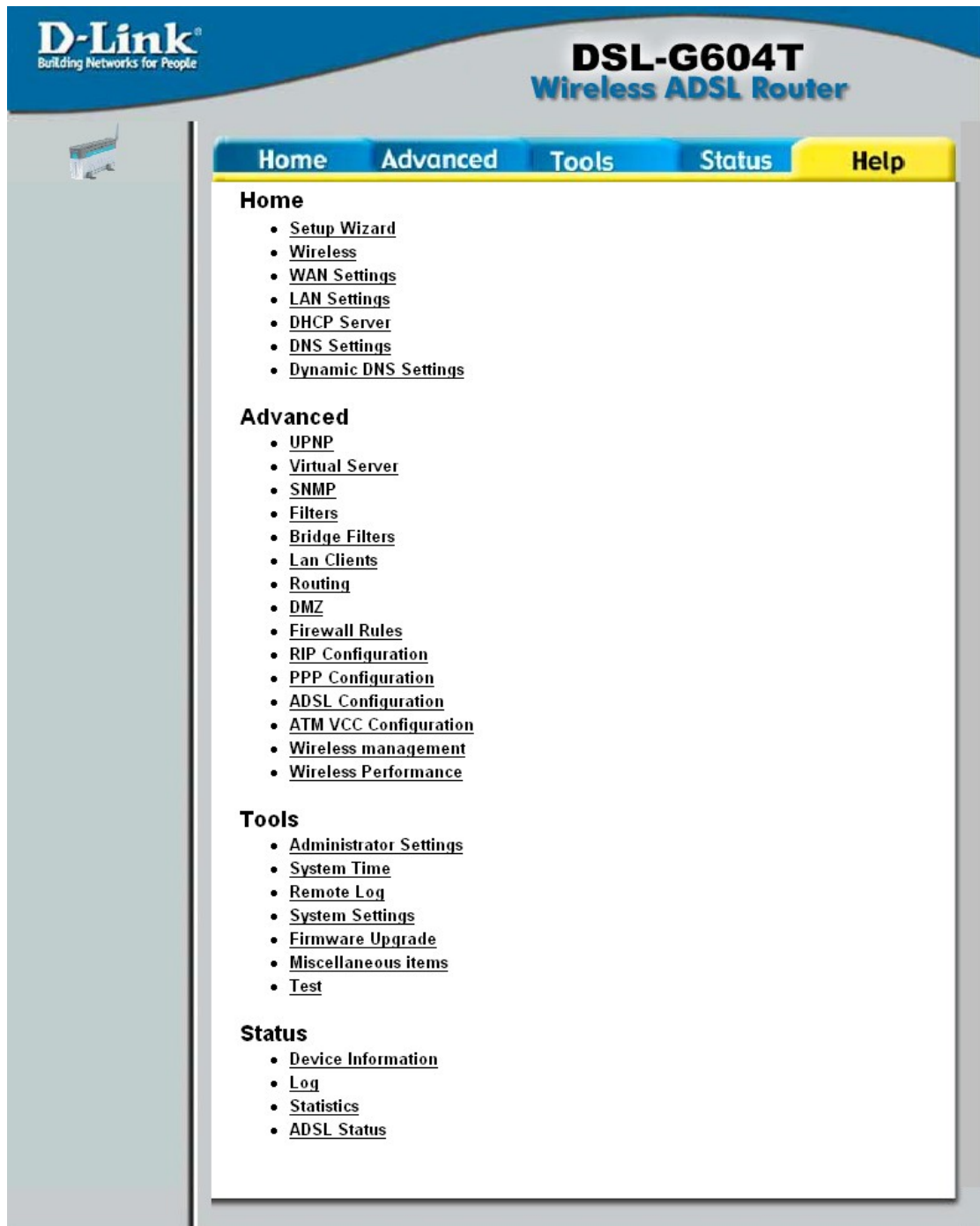

Figure 7- . Help Window

## Technical Specifications

<b>GENERAL</b>	
<b>Standards:</b>	<p><b>ADSL Standards</b> ANSI T1.413 Issue 2 ITU G.992.1 (G.dmt) AnnexA ITU G.992.2 (G.lite) Annex A ITU G.994.1 (G.hs)</p> <p><b>ADSL2 Standards</b> ITU G.992.3 (G.dmt.bis) Annex A ITU G.992.4 (G.lite.bis) Annex A</p> <p><b>ADSL2+ Standards:</b> ITU G.992.5 Annex A</p>
<b>Protocols:</b>	<p>IEEE 802.1d Spanning Tree TCP/UDP ARP RARP ICMP RFC1058 RIP v1 RFC1213 SNMP v1 &amp; v2c RFC1334 PAP RFC1389 RIP v2 RFC1483/2684 Multiprotocol Encapsulation over ATM Adaptation Layer 5 RFC1577 Classical IP over ATM RFC1661 Point to Point Protocol RFC1994 CHAP RFC2131 DHCP Client / DHCP Server RFC2364 PPP over ATM RFC2516 PPP over Ethernet</p>
<b>Data Transfer Rate:</b>	<p>G.dmt full rate downstream: up to 8 Mbps G.dmt full rate upstream: up to 1 Mbps G.lite: ADSL downstream up to 1.5 Mbps G.lite: ADSL upstream up to 512 Kbps G.dmt.bis full rate downstream: up to 12 Mbps G.dmt.bis full rate upstream: up to 12 Mbps</p>

<b>GENERAL</b>	
<b>Standards:</b>	<p><b>ADSL Standards</b> ANSI T1.413 Issue 2 ITU G.992.1 (G.dmt) AnnexA ITU G.992.2 (G.lite) Annex A ITU G.994.1 (G.hs)</p> <p><b>ADSL2 Standards</b> ITU G.992.3 (G.dmt.bis) Annex A ITU G.992.4 (G.lite.bis) Annex A</p> <p><b>ADSL2+ Standards:</b> ITU G.992.5 Annex A</p> <p>ADSL full rate downstream: up to 24 Mbps ADSL full rate upstream: up to 1 Mbps</p>
<b>Media Interface:</b>	<p>ADSL interface: RJ-11 connector for connection to 26 AWG twisted pair telephone line LAN interface: RJ-45 port for 10/100BASE-T Ethernet connection</p>

<b>Physical and Environmental</b>	
<b>DC Inputs: Power Adapter:</b>	<p>Input: 120V AC 60Hz Output: 9V AC, 1A</p>
<b>Power Consumption :</b>	9 Watts (max)
<b>Operating Temperature:</b>	0° to 40°C
<b>Storage Temperature</b>	-20° to 70°C
<b>Humidity:</b>	5% to 95% (non-condensing)
<b>Dimensions:</b>	109 mm x 142.8 mm x 32.1 mm
<b>Weight:</b>	200 gm
<b>EMI:</b>	CE Class B, FCC Class B (Part 15)
<b>Safety:</b>	CSA 950, UL 1950, IEC 60950, EN 60950
<b>Reliability:</b>	Mean Time Between Failure (MTBF) min. 4 years



## IP Address Setup

The DSL-G604T is designed to provide network administrators maximum flexibility for IP addressing on the Ethernet LAN. The easiest IP setup choice in most cases is to let the Router do it using DHCP, which is enabled by default. This appendix briefly describes various options including DHCP, used for IP setup on a LAN. If you are new to IP networking, the next appendix provides some background information on basic IP concepts.

### Assigning Network IP Addresses

The IP address settings, which include the IP address, subnet mask and gateway IP address are the first and most important internal network settings that need to be configured. The Router is assigned a default LAN IP address and subnet mask. If you do not have a preexisting IP network and are setting one up now, using the factory default IP address settings can greatly ease the setup process. If you already have a preexisting IP network, you can adjust the IP settings for the Router to fit within your existing scheme.

### Using the Default IP Address

The Router is shipped with a preset default IP address setting of 192.168.1.1 for the LAN port. There are two ways to use this default IP address, you can manually assign an IP address and subnet mask for each PC on the LAN or you can instruct the Router to automatically assign them using DHCP. The simplest method is to use DHCP. The DHCP function is active by default.

### Manual IP Address Assignment

Manually configuring IP settings for the LAN means you must manually set an IP address, subnet mask and IP address of the default gateway (the Router's IP address) on each networked computer. The example listed below describes IP configuration for computers running Windows 95 or Windows 98. Regardless of what operating system is used on each workstation, the three network IP settings must be defined so the network interface used by each workstation can be identified by the Router, and vice versa. For detailed information about configuring your workstations IP settings, consult the user's guide included with the operating system or the network interface card (NIC).

1. In Windows 95/98, click on the **Start** button, go to **Settings** and choose **Control Panel**.
2. In the window that opens, double-click on the **Network** icon.
3. Under the Configuration tab, select the **TCP/IP** component and click *Properties*.
4. Choose the *Specify an IP address* option and edit the address settings accordingly. Consult the table below for IP settings on a Class C network.

IP Setup - Example #1

Using Default IP without DHCP			
Host	IP Address	Subnet Mask	Gateway IP
<b>Router</b>	192.168.1.1	255.255.255.0	



<b>Computer #1</b>	192.168.1.2	255.255.255.0	192.168.1.1
<b>Computer #2</b>	192.168.1.3	255.255.255.0	192.168.1.1
<b>Computer #3</b>	192.168.1.4	255.255.255.0	192.168.1.1

Please note that when using the default IP address as in the above example, the first three numbers in the IP address must always be the same with only the fourth number changing. The first three numbers define the network IP address (all machines must belong to the same IP network), while the last number denotes the host IP address (each computer must have a unique address to distinguish it on the network). The IP address scheme used in Example #1 can be used for any LAN that requires up to 253 separate IP addresses (excluding the Router). Notice that the subnet mask is the same for all machines and the default gateway address is the LAN IP address of the Router.

It is a good idea to make a note of each device's IP address for reference during troubleshooting or when adding new stations or devices.

### Using DHCP

The second way to use the default settings is to allow the Router to automatically assign IP settings for workstation using DHCP. To do this, simply make sure your computers' IP addresses are set to 0.0.0.0 (under Windows, choose the option Obtain an IP address automatically in the TCP/IP network component described above). When the computers are restarted, their IP settings will automatically be assigned by the Router. The Router is set by default to use DHCP. See the discussion in Chapter 5 for information on how to use configure the Router for DHCP.

### Changing the IP Address of the Router

When planning your LAN IP address setup, you may use any scheme allowed by rules that govern IP assignment. It may be more convenient or easier to remember an IP scheme that use a different address for the Router. Or you may be installing the Router on a network that has already established the IP settings. Changing the IP address is a simple matter and can be done using the web manager (see *LAN IP Address* in Chapter 5). If you are incorporating the Router into a LAN with an existing IP structure, be sure to disable the DHCP function. Also, consider the effects of the NAT function which is enable by default.

An IP addressing scheme commonly used for Ethernet LANs establishes 10.0.0.1 as the base address for the network. Using Example #2 below, the Router is assigned the base address 10.0.0.1 and the remaining addresses are assigned manually or using DHCP.

#### IP Setup - Example #2

Alternative IP Assignment			
Host	IP Address	Subnet Mask	Gateway IP
<b>Router</b>	10.0.0.1	255.255.255.0	
<b>Computer #1</b>	10.0.0.2	255.255.255.0	10.0.0.1
<b>Computer #2</b>	10.0.0.3	255.255.255.0	10.0.0.1

<b>Computer #3</b>	10.0.0.4	255.255.255.0	10.0.0.1
------------------------	----------	---------------	----------

These two examples are only examples you can use to help you get started. If you are interested in more advanced information on how to use IP addressing on a LAN there are numerous resources freely available on the Internet. There are also many books and chapters of books on the subject of IP address assignment, IP networking and the TCP/IP protocol suite.



## IP Concepts

This appendix describes some basic IP concepts, the TCP/IP addressing scheme and show how to assign IP Addresses.

When setting up the Router, you must make sure it has a valid IP address. Even if you will not use the WAN port (ADSL port), you should, at the very least, make sure the Ethernet LAN port is assigned a valid IP address. This is required for telnet, in-band SNMP management, and related functions such as “trap” handling and TFTP firmware download.

### IP Addresses

The Internet Protocol (IP) was designed for routing data between network sites all over the world, and was later adapted for routing data between networks within any site (often referred to as “subnetworks” or “subnets”). IP includes a system by which a unique number can be assigned to each of the millions of networks and each of the computers on those networks. Such a number is called an IP address.

To make IP addresses easy to understand, the originators of IP adopted a system of representation called “dotted decimal” or “dotted quad” notation. Below are examples of IP addresses written in this format:

201.202.203.204      189.21.241.56      125.87.0.1

Each of the four values in an IP address is the ordinary decimal (base 10) representation of a value that a computer can handle using eight “bits” (binary digits — 1s and 0s). The dots are simply convenient visual separators.

Zeros are often used as placeholders in dotted decimal notation; 189.21.241.56 can therefore also appear as 189.021.241.056.

IP networks are divided into three classes on the basis of size. A full IP address contains a network portion and a “host” (device) portion. The network and host portions of the address are different lengths for different classes of networks, as shown in the table below.

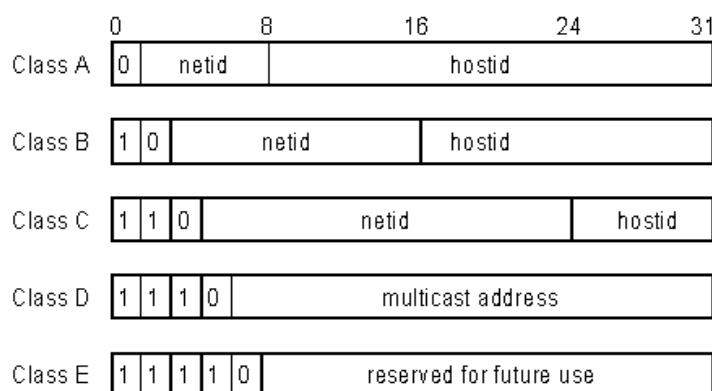

Networks attached to the Internet are assigned class types that determine the maximum number of possible hosts per network. The previous figure illustrates how the net and host portions of the IP

address differ among the three classes. Class A is assigned to networks that have more than 65,535 hosts; Class B is for networks that have 256 to 65534 hosts; Class C is for networks with less than 256 hosts.

IP Network Classes			
Class	Maximum Number of Networks in Class	Network Addresses (Host Portion in Parenthesis)	Maximum Number of Hosts per Network
A	126	1(.0.0.0) to 126(.0.0.0)	16,777,214
B	16,382	128.1(.0.0) to 191.254(.0.0)	65,534
C	2,097,150	192.0.1(.0) to 223.255.254(.0)	254

**Note:** All network addresses outside of these ranges (Class D and E) are either reserved or set aside for experimental networks or multicasting.

When an IP address's host portion contains only zero(s), the address identifies a network and not a host. No physical device may be given such an address.

The network portion must start with a value from 1 to 126 or from 128 to 223. Any other value(s) in the network portion may be from 0 to 255, except that in class B the network addresses 128.0.0.0 and 191.255.0.0 are reserved, and in class C the network addresses 192.0.0.0 and 223.255.255.0 are reserved.

The value(s) in the host portion of a physical device's IP address can be in the range of 0 through 255 as long as this portion is not all-0 or all-255. Values outside the range of 0 to 255 can never appear in an IP address (0 to 255 is the full range of integer values that can be expressed with eight bits).

The network portion must be the same for all the IP devices on a discrete physical network (a single Ethernet LAN, for example, or a WAN link). The host portion must be different for each IP device — or, to be more precise, each IP-capable port or interface — connected directly to that network.

The network portion of an IP address will be referred to in this manual as a **network number**; the host portion will be referred to as a **host number**.

To connect to the Internet or to any private IP network that uses an Internet-assigned network number, you must obtain a registered IP network number from an Internet-authorized network information center. In many countries you must apply through a government agency, however they can usually be obtained from your Internet Service Provider (ISP).

If your organization's networks are, and will always remain, a closed system with no connection to the Internet or to any other IP network, you can choose your own network numbers as long as they conform to the above rules.

If your networks are isolated from the Internet, e.g. only between your two branch offices, you can assign any IP Addresses to hosts without problems. However, the Internet Assigned Numbers Authority (IANA) has reserved the following three blocks of IP Addresses specifically for private (stub) networks:

Class	Beginning Address	Ending Address
A	10.0.0.0	10.255.255.255
B	172.16.0.0	172.31.255.255
C	192.168.0.0	192.168.255.255

It is recommended that you choose private network IP Addresses from the above list. For more information on address assignment, refer to RFC 1597, *Address Allocation for Private Internets* and RFC 1466, *Guidelines for Management of IP Address Space*.

## **Subnet Mask**

In the absence of subnetworks, standard TCP/IP addressing may be used by specifying subnet masks as shown below.

<b>IP Class</b>	<b>Subnet Mask</b>
Class A	255.0.0.0
Class B	255.255.0.0
Class C	255.255.255.0

Subnet mask settings other than those listed above add significance to the interpretation of bits in the IP address. The bits of the subnet mask correspond directly to the bits of the IP address. Any bit and a subnet mask that is to correspond to a net ID bit in the IP address must be set to 1.

## Microfilters and Splitters

Most ADSL clients will be required to install a simple device that prevents the ADSL line from interfering with regular telephone services. These devices are commonly referred to as microfilters or sometimes called (inaccurately) line splitters. They are easy to install and use standard telephone connectors and cable.

Some ADSL service providers will send a telecommunications technician to modify the telephone line, usually at the point where the telephone line enters the building. If a technician has divided or split your telephone line into two separate lines - one for regular telephone service and the other for ADSL – then you do not need to use any type of filter device. Follow the instructions given to you by your ADSL service provider about where and how you should connect the Router to the ADSL line.

### Microfilters

Unless you are instructed to use a “line splitter” (see below), it will be necessary to install a microfilter (low pass filter) device for each telephone or telephone device (answering machines, Faxes etc.) that share the line with the ADSL service. Microfilters are easy-to-install, in-line devices, which attach to the telephone cable between the telephone and wall jack. Microfilters that install behind the wall plate are also available. A typical in-line microfilter installation is shown in the diagram below.

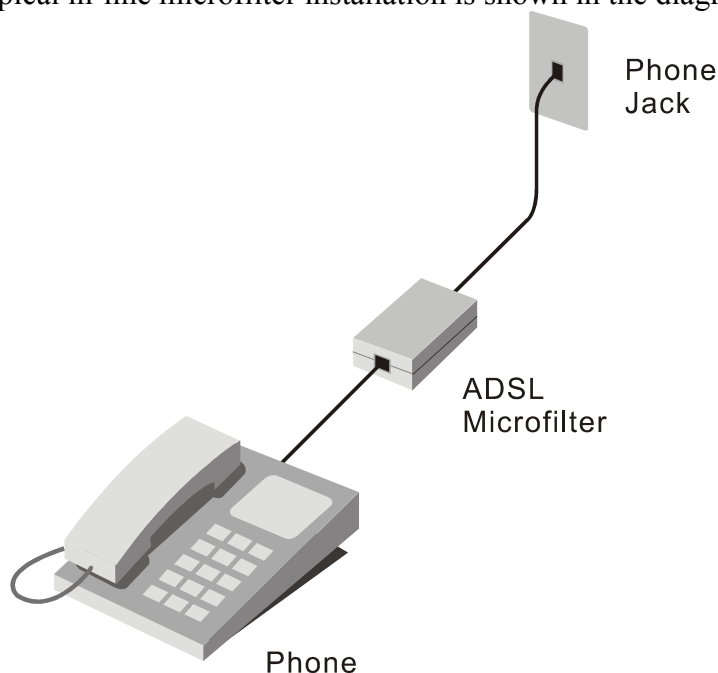

**Microfilter Installation**

**Important:** Do not install the microfilter between the Router and the telephone jack. Microfilters are only intended for use with regular telephones, Fax machines and other regular telephone devices.

## Line Splitter

If you are instructed to use a “line splitter”, you must install the device between the Router and the phone jack. Use standard telephone cable with standard RJ-11 connectors. The splitter has three RJ-11 ports used to connect to the wall jack, the Router and if desired, a telephone or telephone device. The connection ports are typically labeled as follows:

**Line** - This port connects to the wall jack.

**ADSL** – This port connects to the Router.

**Phone** – This port connects to a telephone or other telephone device.

The diagram below illustrates the proper use of the splitter.

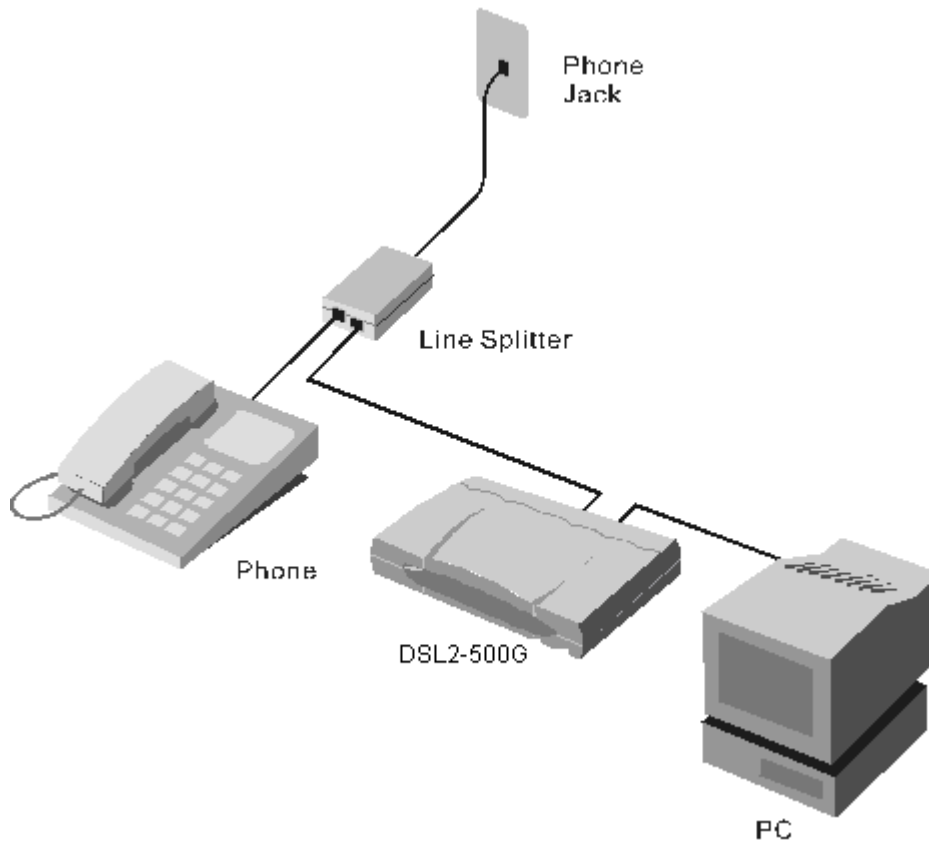

**Line Splitter Installation**



# International Offices

---

## U.S.A

17595 Mt. Herrmann Street  
Fountain Valley, CA. 92708  
TEL: 714-885-6000  
Fax 866-743-4905  
URL: [www.dlink.com](http://www.dlink.com)

## Canada

2180 Winston Park Drive  
Oakville, Ontario, L6H 5W1  
Canada  
TEL: 1-905-8295033  
FAX: 1-905-8295223  
URL: [www.dlink.ca](http://www.dlink.ca)

## Europe (U. K.)

4th Floor, Merit House  
Edgware Road, Colindale  
London NW9 5AB  
U.K.  
TEL: 44-20-8731-5555  
FAX: 44-20-8731-5511  
URL: [www.dlink.co.uk](http://www.dlink.co.uk)

## Germany

Schwalbacher Strasse 74  
D-65760 Eschborn  
Germany  
TEL: 49-6196-77990  
FAX: 49-6196-7799300  
URL: [www.dlink.de](http://www.dlink.de)

## France

Le Florilege #.2, Allee de la Fresnerie  
78330 Fontenay le Fleury  
France  
TEL: 33-1-30238688  
FAX: 33-1-30238689  
URL: [www.dlink-france.fr](http://www.dlink-france.fr)

## Netherlands

Weena 290  
3012 NJ Rotterdam  
Netherlands  
Tel: +31-10-282-1445  
Fax: +31-10-282-1331  
URL: [www.dlink-benelux.com](http://www.dlink-benelux.com)

## Belgium

Rue des Colonies 11  
B-1000 Brussels  
Belgium  
Tel: +32(0)2 517 7111  
Fax: +32(0)2 517 6500  
URL: [www.dlink-benelux.com](http://www.dlink-benelux.com)

## Italy

Via Nino Bonnet n. 6/b  
20154 – Milano,  
Italy  
TEL: 39-02-2900-0676  
FAX: 39-02-2900-1723  
URL: [www.dlink.it](http://www.dlink.it)

## Sweden

P.O. Box 15036, S-167 15 Bromma  
Sweden  
TEL: 46-(0)8564-61900  
FAX: 46-(0)8564-61901  
URL: [www.dlink.se](http://www.dlink.se)

## Denmark

Naverland 2, DK-2600  
Glostrup, Copenhagen,  
TEL: 45-43-969040  
FAX: 45-43-424347  
URL: [www.dlink.dk](http://www.dlink.dk)

## Norway

Karihaugveien 89  
1086 Oslo  
Norway  
TEL: 47-23-897189  
FAX: 47-22-309085  
URL: [www.dlink.no](http://www.dlink.no)

## Finland

Pakkalankuja 7A  
01510 Vantaa,  
Finland  
TEL : +358-9-2707 5080  
FAX: + 358-9-2707 5081  
URL: [www.dlink.fi](http://www.dlink.fi)

## Iberia

C/Sabino De Arana,  
56 Bajos  
08028 Barcelona  
TEL: 34 93 4090770  
FAX: 34 93 4910795  
URL: [www.dlinkiberia.es](http://www.dlinkiberia.es)

## Singapore

1 International Business Park  
#03-12 The Synergy  
Singapore 609917  
TEL: 65-6774-6233  
FAX: 65-6774-6322  
URL: [www.dlink-intl.com](http://www.dlink-intl.com)

## Australia

1 Giffnock Avenue,  
North Ryde, NSW 2113  
Australia  
TEL: 61-2-8899-1800  
FAX: 61-2-8899-1868  
URL: [www.dlink.com.au](http://www.dlink.com.au)

## India

D-Link House, Kurla Bandra Complex  
Road,  
Off CST Road, Santacruz (East), Mumbai -  
400098.  
India  
TEL: 91-022-26526696/56902210  
FAX: 91-022-26528914  
URL: [www.dlink.co.in](http://www.dlink.co.in)

## Middle East (Dubai)

P.O.Box: 500376  
Office No.:103, Building:3  
Dubai Internet City  
Dubai, United Arab Emirates  
Tel:+971-4-3916480  
Fax:+971-4-3908881  
URL: [www.dlink-me.com](http://www.dlink-me.com)

## Turkey

Regus Offices  
Beybi Giz Plaza, Ayazaga Mah. Meydan  
Sok. No:28  
Maslak 34396, Istanbul-Turkiye  
TEL: +90 212 335 2553  
FAX: +90 212 335 2500  
URL: [www.dlink.com.tr](http://www.dlink.com.tr)

## Egypt

19 El-Shahed Helmy, El Masri  
Al-Maza, Heliopolis  
Cairo, Egypt.  
TEL:+202 414 4295  
FAX:+202 415 6704  
URL: [www.dlink-me.com](http://www.dlink-me.com)

## Israel

11 Hamanofim Street  
Ackerstein Towers, Regus Business Center  
P.O.B 2148, Hertzelia-Pituach 46120.  
Israel  
TEL: +972-9-9715700  
FAX: +972-9-9715601  
URL: [www.dlink.co.il](http://www.dlink.co.il)

## LatinAmerica

Isidora Goyechea 2934 of 702,  
Las Condes  
Santiago – Chile S.A.  
TEL: 56-2-232-3185  
FAX: 56-2-232-0923  
URL: [www.dlink.cl](http://www.dlink.cl)

## Brasil

Av das Nacoes Unidas,  
11857 - 14 - andar - cj 141/142  
Brooklin Novo  
Sao Paulo - SP - Brazil  
CEP 04578-000  
TEL: +55 11 55039320  
FAX: +55 11 55039322  
URL: [www.dlinkbrasil.com.br](http://www.dlinkbrasil.com.br)

## South Africa

Einstein Park II  
Block B  
102-106 Witch-Hazel Avenue  
Highveld Technopark  
Centurion  
Gauteng  
Republic of South Africa  
TEL: 27-12-665-2165  
FAX: 27-12-665-2186  
URL: [www.d-link.co.za](http://www.d-link.co.za)

## Russia

Grafsky per., 14, floor 6  
Moscow  
129626 Russia  
TEL: 7-095-744-0099  
FAX: 7-095-744-0099 #350  
URL: [www.dlink.ru](http://www.dlink.ru)

## China

No.202,C1 Building, Huitong Office Park,  
No.71, Jianguo Road, Chaoyang District,  
Beijing,  
100025, China.  
TEL +86-10-58635800  
FAX: +86-10-58635799  
URL: [www.dlink.com.cn](http://www.dlink.com.cn)

## Taiwan

2F, No. 119, Pao-Chung Rd.  
Hsin-Tien, Taipei  
Taiwan  
TEL: 886-2-2910-2626  
FAX: 886-2-2910-1515  
URL: [www.dlinktw.com.tw](http://www.dlinktw.com.tw)

## Headquarters

2F, No. 233-2, Pao-Chiao Rd.  
Hsin-Tien, Taipei  
Taiwan  
TEL: 886-2-2916-1600  
FAX: 886-2-2914-6299  
URL: [www.dlink.com](http://www.dlink.com)

# Registration Card

*Print, type or use block letters.*

Your name: Mr./Ms \_\_\_\_\_

Organization: \_\_\_\_\_ Dept. \_\_\_\_\_

Your title at organization: \_\_\_\_\_

Telephone: \_\_\_\_\_ Fax: \_\_\_\_\_

Organization's full address: \_\_\_\_\_

Country: \_\_\_\_\_

Date of purchase (Month/Day/Year): \_\_\_\_\_

Product Model	Product Serial No.	* Product installed in type of computer (e.g., Compaq 486)	* Product installed in computer serial No.

(\* Applies to adapters only)

*Product was purchased from:*

Reseller's name: \_\_\_\_\_

Telephone: \_\_\_\_\_ Fax: \_\_\_\_\_

Reseller's full address: \_\_\_\_\_

**Answers to the following questions help us to support your product:**

**1. Where and how will the product primarily be used?**

Home  Office  Travel  Company Business  Home Business  Personal Use

**2. How many employees work at installation site?**

1 employee  2-9  10-49  50-99  100-499  500-999  1000 or more

**3. What network protocol(s) does your organization use ?**

XNS/IPX  TCP/IP  DECnet  Others \_\_\_\_\_

**4. What network operating system(s) does your organization use ?**

D-Link LANsmart  Novell NetWare  NetWare Lite  SCO Unix/Xenix  PC NFS  3Com 3+Open

Banyan Vines  DECnet Pathwork  Windows NT  Windows NTAS  Windows '95

Others \_\_\_\_\_

**5. What network management program does your organization use ?**

D-View  HP OpenView/Windows  HP OpenView/Unix  SunNet Manager  Novell NMS

NetView 6000  Others \_\_\_\_\_

**6. What network medium/media does your organization use ?**

Fiber-optics  Thick coax Ethernet  Thin coax Ethernet  10BASE-T UTP/STP

100BASE-TX  100BASE-T4  100VGAnyLAN  Others \_\_\_\_\_

**7. What applications are used on your network?**

Desktop publishing  Spreadsheet  Word processing  CAD/CAM

Database management  Accounting  Others \_\_\_\_\_

**8. What category best describes your company?**

Aerospace  Engineering  Education  Finance  Hospital  Legal  Insurance/Real Estate  Manufacturing

Retail/Chainstore/Wholesale  Government  Transportation/Utilities/Communication  VAR

System house/company  Other \_\_\_\_\_

**9. Would you recommend your D-Link product to a friend?**

Yes  No  Don't know yet

**10. Your comments on this product?** \_\_\_\_\_

\_\_\_\_\_  
\_\_\_\_\_  
\_\_\_\_\_  
\_\_\_\_\_

PLEASE  
PLACE STAMP  
HERE

**TO:**

---

---

---

**D-Link®**