



User Manual

Vigilance HD Outdoor PoE Mini Bullet Camera

DCS-4701E

Preface

D-Link reserves the right to revise this publication and to make changes in the content hereof without obligation to notify any person or organization of such revisions or changes. Information in this document may become obsolete as our services and websites develop and change.

Manual Revisions

Revision	Date	Description
1.0	April 21, 2015	DCS-4701E Revision A1 with firmware version 1.00
1.01	July 05, 2016	Add Regulatory Information

Trademarks

D-Link and the D-Link logo are trademarks or registered trademarks of D-Link Corporation or its subsidiaries in the United States or other countries. All other company or product names mentioned herein are trademarks or registered trademarks of their respective companies.

Copyright © 2016 D-Link Corporation.







All rights reserved. This publication may not be reproduced, in whole or in part, without prior expressed written permission from D-Link Corporation.

Table of Contents

Product Overview.....	4	Advanced.....	45
Package Contents.....	4	ICR and IR.....	45
Introduction.....	5	HTTPS.....	46
System Requirements	5	Access List.....	47
Features.....	6	SNMP	48
Hardware Overview	7	Maintenance.....	50
Front and Back.....	7	Device Management	50
Sides	8	System	51
Mounting the Camera.....	9	Firmware Upgrade.....	52
Waterproofing Your Installation	11	Status	53
Software Installation.....	14	Device Info	53
Configuration	17	Logs	54
Using the Configuration Interface.....	17	Help.....	55
Live Video	19	Technical Specifications.....	56
Setup	21	Regulatory Information	59
Setup Wizard	21		
Network Setup.....	26		
Dynamic DNS	29		
Image Setup	30		
Video	32		
Preset.....	34		
Motion Detection	36		
Time and Date.....	37		
Event Setup.....	38		

Product Overview

Package Contents

-  DCS-4701E Vigilance HD Outdoor PoE Mini Bullet Camera
-  Cable Waterproofing Connector
-  Rubber Power Connector Plug
-  Mounting Kit
-  CD-ROM with User Manual and software
-  Quick Installation Guide



If any of the above items are missing, please contact your reseller.

Safety Notice: Installation and servicing should be done by certified technicians so as to conform to all local codes and prevent voiding your warranty.

Introduction

Congratulations on your purchase of the DCS-4701E Vigilance HD Outdoor PoE Mini Bullet Camera. The DCS-4701E is a professional surveillance and security solution for small, medium, and large enterprises alike. The DCS-4701E uses an HD progressive scan CMOS sensor; the professional sensor results in low noise and high sensitivity capabilities ideal for surveillance applications.

The DCS-4701E is a complete system with a built-in CPU and incorporates a web server, allowing it to transmit excellent real-time Full HD resolution video for security and outdoor surveillance.

The DCS-4701E can be accessed remotely, controlled and configured from any PC/Notebook over your local network or through the Internet via a web browser. The simple installation and intuitive web-based interface offer easy configuration across the full range of its advanced feature set, including granular control over multiple video streams with different configurations and multicast video streams which helps you manage your network load.

The DCS-4701E has an IP66 certified weatherproof housing designed for both indoor and outdoor applications. The built-in removable IR-cut filter and IR LEDs give the DCS-4701E the capability to view up to 30M at night. The DCS-4701E also incorporates Power over Ethernet (PoE), allowing it to be easily installed in a variety of locations without the need for supplemental power cabling. The combination of IP66 weatherproof housing, IR-Cut Filter, IR LEDs, and PoE make the DCS-4701E an ideal solution for a dependable and cost-effective 24 hour surveillance solution with easy clutter-free installation.

System Requirements

- Computer with Microsoft Windows® 8, 7, or Vista® (for CD-ROM Setup Wizard), Mac OS or Linux
- Internet Explorer 7, Firefox 20, Chrome 20, or Safari 6 or higher
- Existing 10/100 Ethernet-based network with an available 802.3af Power over Ethernet (PoE) port

Features

Simple to Maintain

The DCS-4701E is a stand-alone system with a built-in CPU, requiring no special hardware or software. The DCS-4701E can be viewed and managed through most web browsers, including Internet Explorer®, Chrome®, Firefox®, and Safari®.

Supports a Variety of Platforms

With support for TCP/IP networking, HTTP, and other Internet related protocols, the DCS-4701E can also be integrated easily into other Internet/ Intranet applications because of its standards-based features. The DCS-4701E works with any 10/100 Ethernet network, making the DCS-4701E easy to integrate into your existing network environment.

Advanced Event Management

The DCS-4701E can be set up to send e-mail notifications with snapshots when an event occurs, such as when motion is detected. Events can be triggered from several sources, such as motion detection and time based events.

IR LEDs for Day and Night Functionality

The built-in infrared LEDs enable night time viewing of up to 30 meters.

IP66 Weatherproof Housing

The DCS-4701E uses an IP66 weatherproof housing, allowing you to rest assured that in the toughest of conditions, it will continue to provide round-the-clock surveillance.

PoE (Power over Ethernet) for Flexible Installation

The DCS-4701E can draw all the power it needs from a PoE switch or PoE injector for a simple and clutter-free installation.

Remote Monitoring Utility

The D-ViewCam application adds enhanced features and functionality for the Network Camera and allows administrators to configure and access the Network Camera from a remote site via Intranet or Internet. Other features include image monitoring, recording images to a hard drive, viewing up to 32 cameras on one screen, and taking snapshots.

Hardware Overview Front and Back

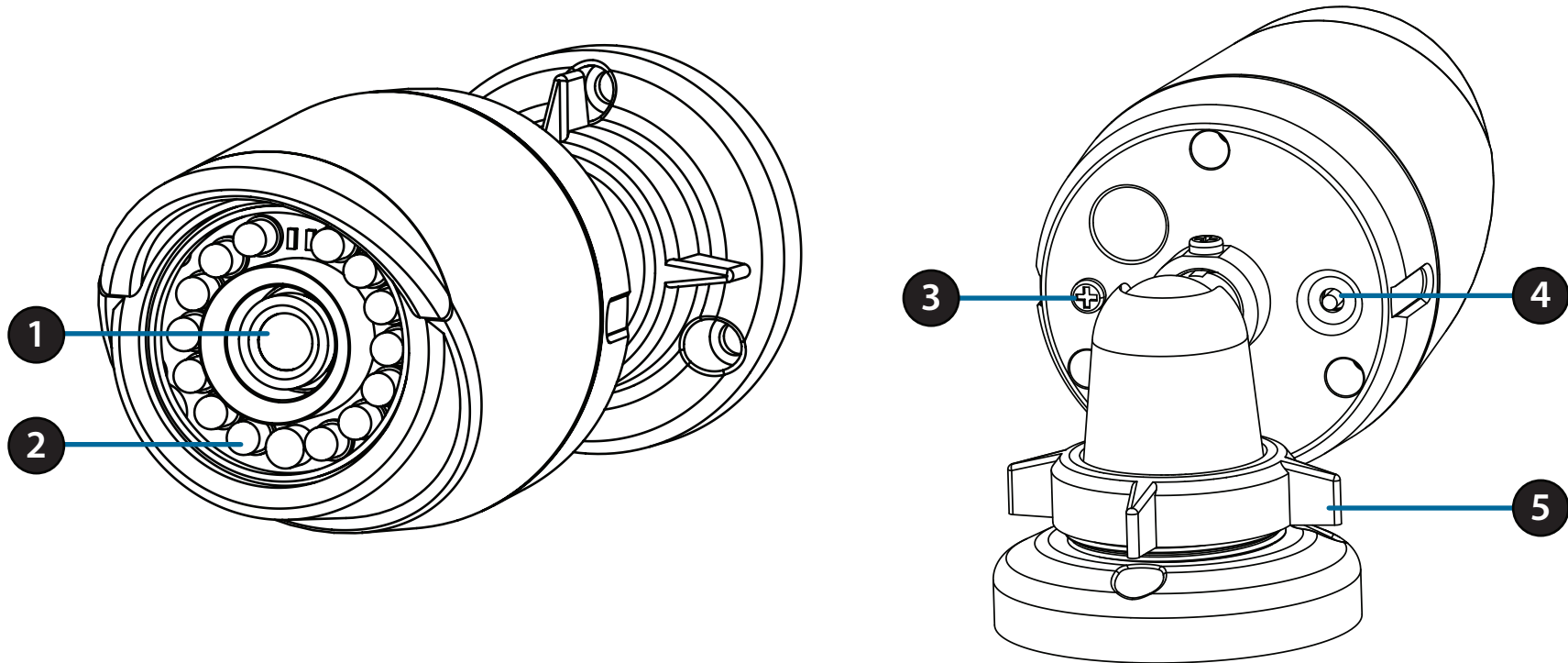

1	Camera Lens	Fixed lens to record video of the surrounding area
2	IR LEDs	Infrared LEDs illuminate the camera's field of view at night
3	Grounding Screw	Can be attached to a grounding wire if desired
4	Reset Button	Press and hold for 10 seconds to reset camera back to the factory default settings
5	Adjustment Ring	Loosen to adjust camera angle and tighten to lock camera angle

Sides

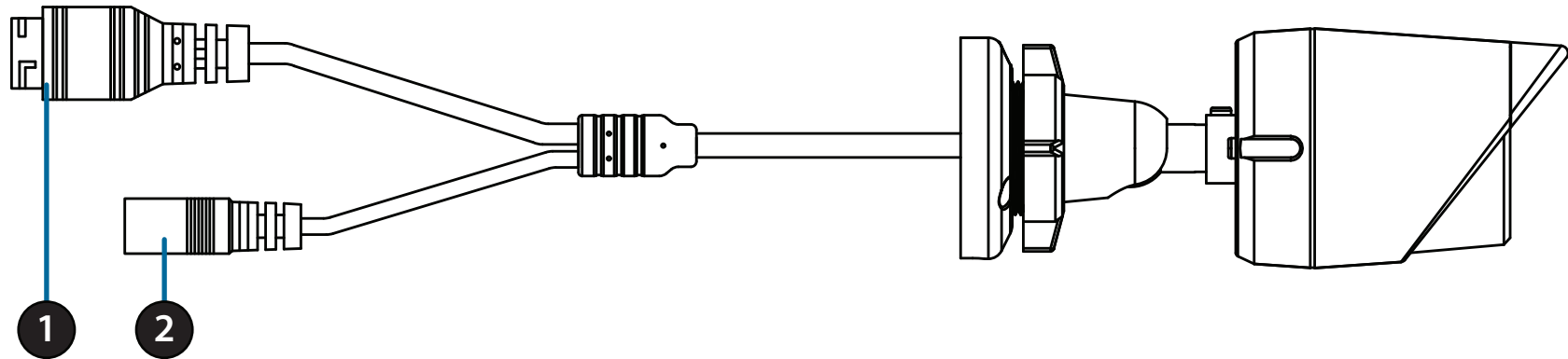

1	Ethernet Jack	RJ-45 connector for Ethernet, can also be used to power the camera using Power over Ethernet (PoE)
2	Power Connector	Connects to an optional 12 V / 1.5 A power adapter (not included)

Mounting the Camera

It is highly recommended that you configure and test your camera before mounting it.

Step 1

Place the mounting sticker where you want to position the camera. Make sure the camera base will be positioned so that the cable channel is on the bottom.

Use a 6 mm drill bit to make the required holes approximately 25 mm deep, then insert the wall anchors into the holes.

If you are running the camera cables through the wall, drill a hole in the center and pull the cables through the hole.

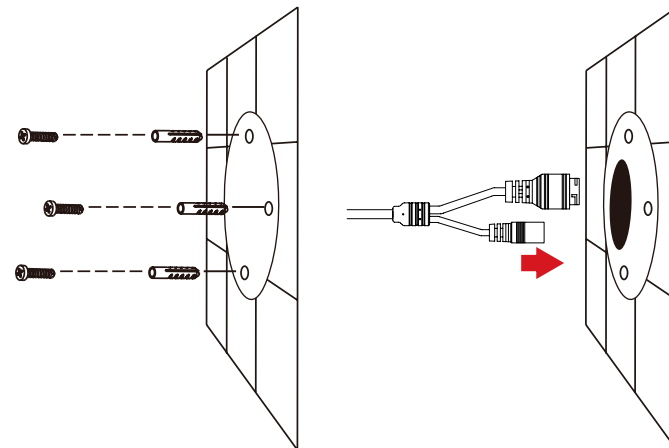

Step 2

Use the screws provided to mount the camera to the wall.

If you are running the camera cables out the side of the camera, guide the camera cables through the cable channel on the base.

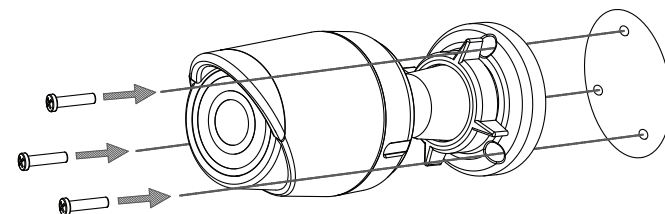

Step 3

Connect the power and Ethernet cables, or just the Ethernet cable if you are using a PoE connection.

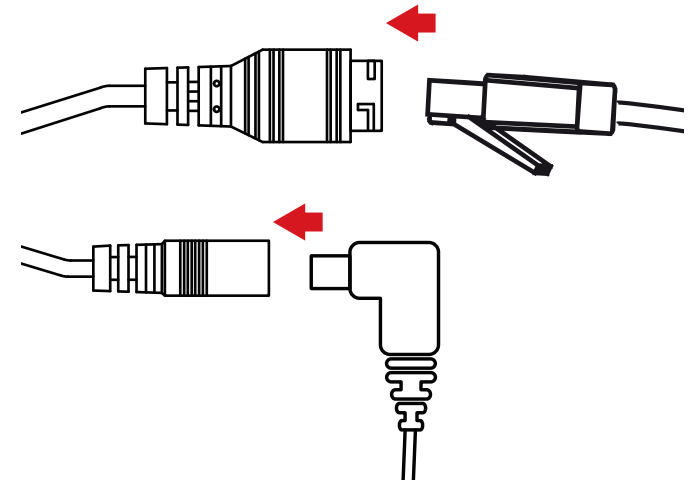

Step 4

To adjust the camera's angle, turn the adjustment ring counterclockwise to loosen it, then move the camera to the desired position and angle. When you are finished, turn the adjustment ring clockwise to tighten it.

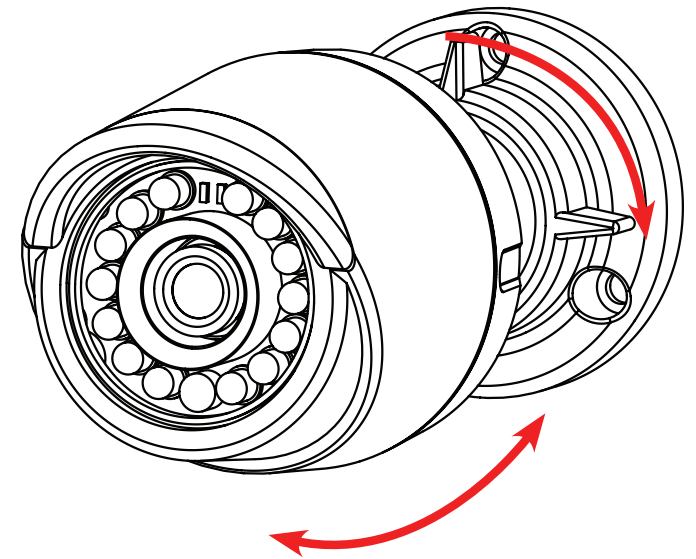

If you need to waterproof your installation, please continue to the next page.

Waterproofing Your Installation

To waterproof your camera installation, follow the instructions below. Round Ethernet cable, a crimping tool, and RJ-45 plugs are required for this procedure.

Step 1

Place the washer around the base of the Ethernet connector as shown.

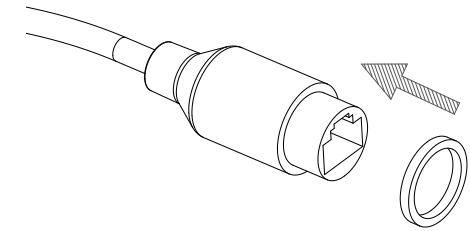

Step 2

Thread bare Ethernet cable through the waterproof connector as shown, then crimp an RJ-45 plug onto the cable.

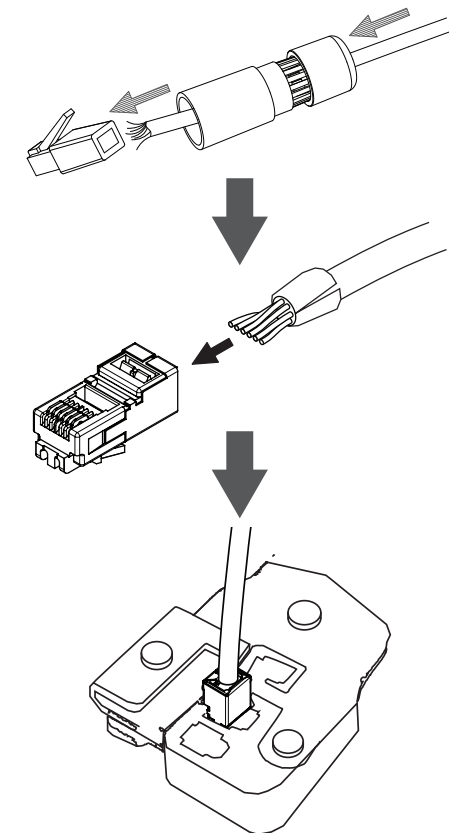

Step 3

Connect the RJ-45 plug into the Ethernet connector, then screw the waterproof connector to the Ethernet connector by turning it about a half-turn clockwise.

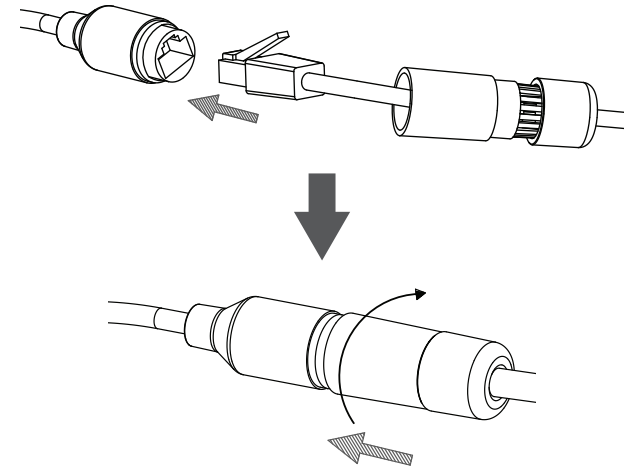

Step 4

Screw the back part of the waterproof connector clockwise until there is a tight seal around the Ethernet cable.

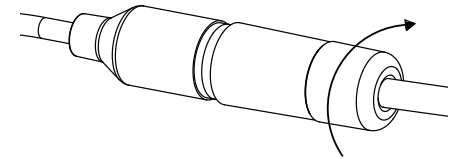

If you are using PoE to power your camera, use the included rubber power connector plug to the power connector.

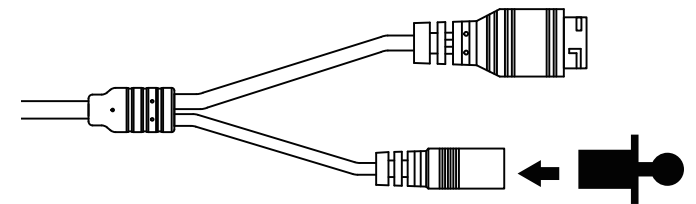

If you are using a power adapter(not included) to power your camera, wind waterproof tape around the connection in an overlapping manner to cover it.

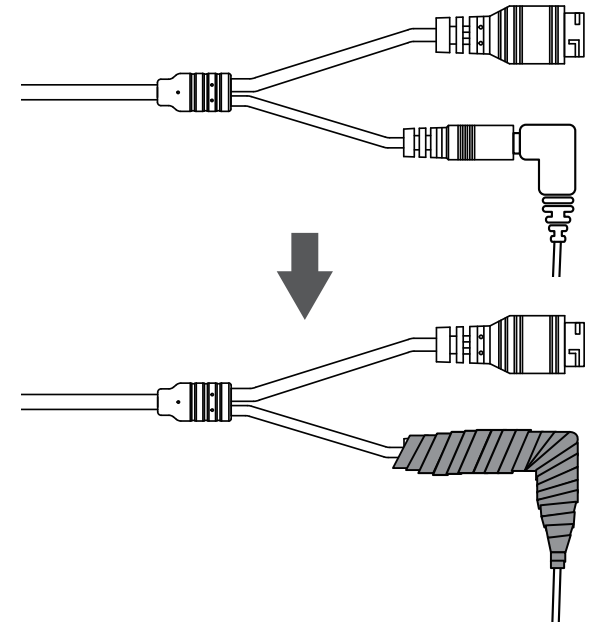

Software Installation

Step 1

Insert the DCS-4701E CD into your computer's CD-ROM drive to begin the installation.

If the Autorun function on your computer is disabled, or if the D-Link Launcher fails to start automatically, click the Start button and type **D:\autorun.exe** (where D: represents the drive letter of your CD-ROM drive) and press Enter.



Step 2

Click on the **D-Link Setup Wizard SE** icon that was created in your Windows Start menu (**Start > D-Link > Setup Wizard SE**).

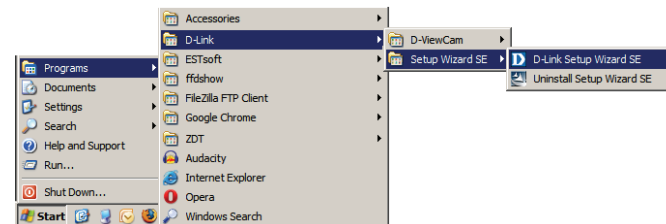

Step 3

The Setup Wizard will appear and display the MAC address and IP address of your camera(s). If you have a DHCP server on your network, a valid IP Address will be displayed. If your network does not use a DHCP server, the network camera's default static IP **192.168.0.20** will be displayed.

Select your camera, then click the **Wizard** button to continue.

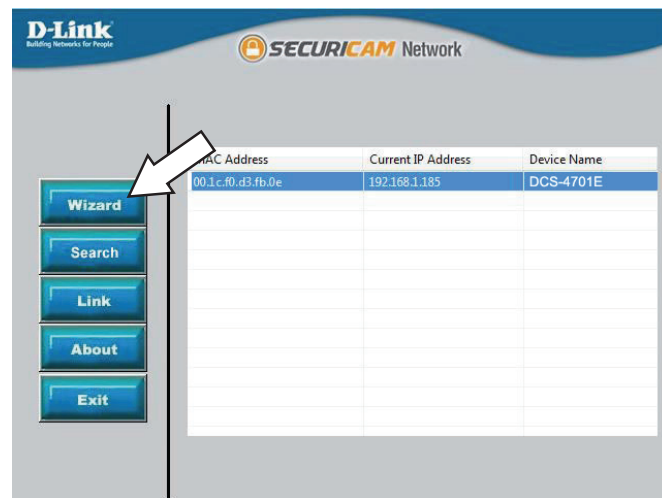

Step 4

Enter the Admin ID and password. When logging in for the first time, the default Admin ID is **admin** with the password left blank.

Click the checkboxes if you wish to change the admin ID and password for the camera, and enter the new ID and password you wish to use.

Click **Next** to continue.

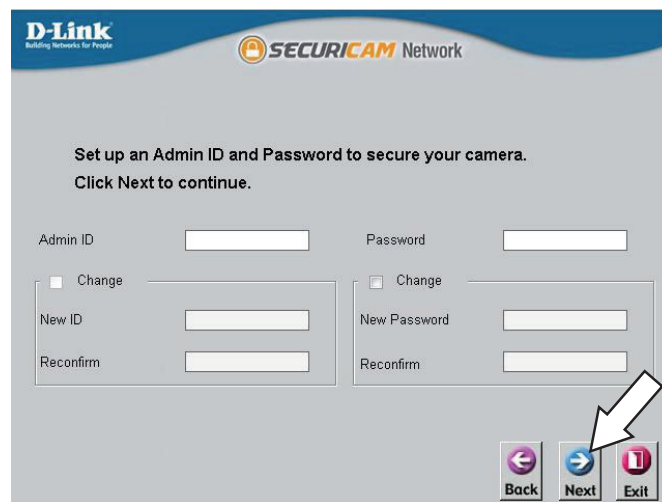

Step 5

Select **DHCP** if your camera obtains an IP address automatically from a DHCP server such as a router. Select **Static IP** if you want to manually enter the IP settings for the camera.

Click **Next** to continue.

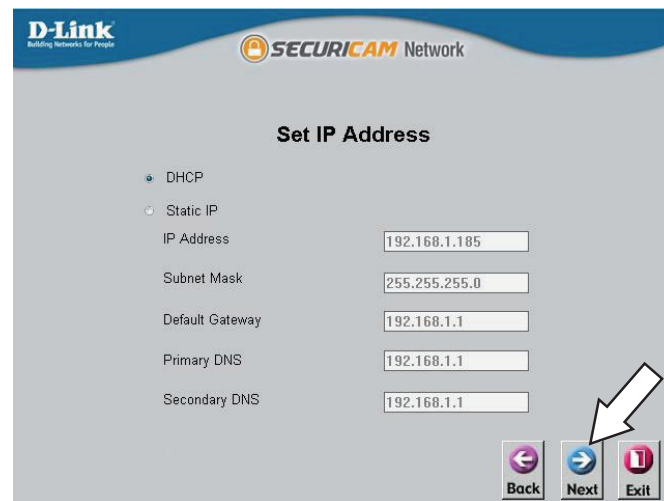

Step 6

Take a moment to confirm your settings and click **Restart**.

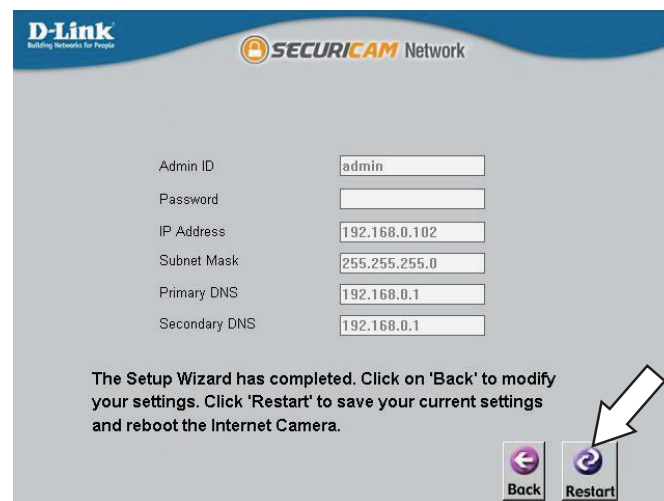

Configuration

Using the Configuration Interface

After completing the Camera Installation Wizard, you are ready to use your camera. The camera's built-in Web configuration utility is designed to allow you to easily access and configure your DCS-4701E. At the end of the wizard, click **Link**, or enter the IP address of your camera into a web browser, such as Mozilla Firefox. To log in, use the User name **admin** and the password you created in the Installation Wizard. If you did not create a password, the default password is blank. After entering your password, click **OK**.

Step 1

Click on the **D-Link Setup Wizard SE** icon that was created in your Windows Start menu (**Start > D-Link > Setup Wizard SE**).

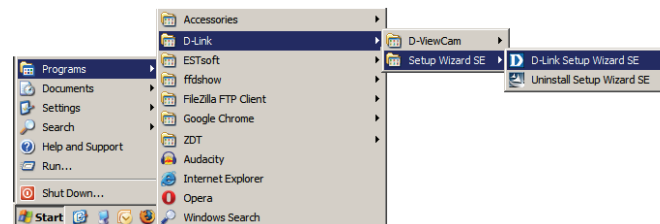

Step 2

Select the camera and click **Link** to access the web configuration.

The Setup Wizard will automatically open your web browser to the IP address of the camera.

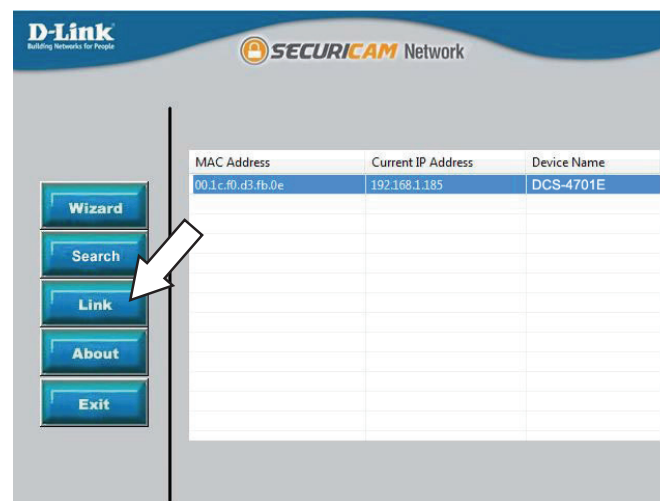

Step 3

Enter **admin** as the default username and leave the password blank. Click **OK** to continue.



Step 4



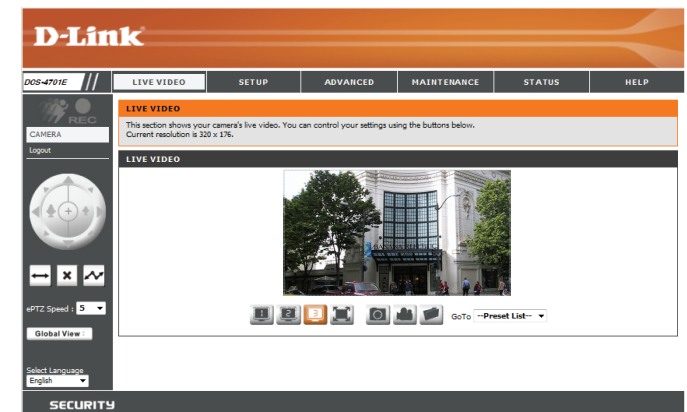



This section displays your camera's live video. You can select your video profile and view or operate the camera.



Live Video

This section shows your camera's live video. You may select any of the available icons listed below to operate the camera. You may also select your language using the drop-down menu on the left side of the screen.

You can zoom in and out on the live video image using your mouse. Right-click to zoom out or left-click to zoom in on the image.



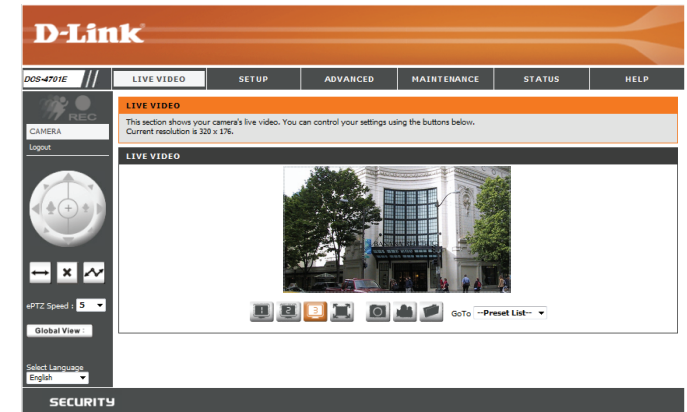

	Motion Trigger Indicator	This indicator will change color when a trigger event occurs. Note: The video motion feature for your camera must be enabled.
	Recording Indicator	When a recording is in progress, this indicator will change color.
	Control Pad	This control pad can be used to electronically pan, tilt, and zoom (ePTZ) within the camera's predefined view area, if one has been defined.
	Auto Pan	Starts the automatic panning function. The ROI will pan from back and forth within the FOV.
	Stop	Stops the camera ePTZ motion.
	Preset Path	Starts the camera's motion along the predefined path.



ePTZ Speed: You may select a value between 0 and 10. 0 is the slowest and 10 is the fastest.

Global View: This window indicates the total field of view (FOV) of the camera. The red box indicates the visible region of interest (ROI).

Language: You may select the interface language using this menu.

- | | | | |
|---|------------------|---|----------------------|
|  | Video Profile 1 |  | Record a Video Clip |
|  | Video Profile 2 |  | Set a Storage Folder |
|  | Video Profile 3 | | |
|  | Full screen mode | | |
|  | Take a Snapshot | | |

Go To: If any presets have been defined, you can select them here to move the **(Preset List)** camera to the selected preset.

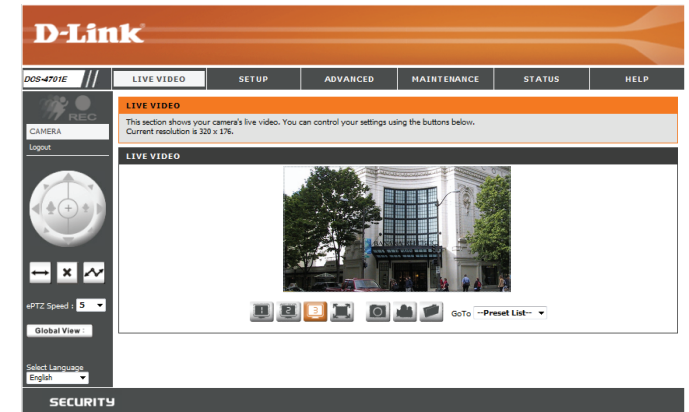

Setup Setup Wizard

To configure your Network Camera, click **Internet Connection Setup Wizard**. Alternatively, you may click **Manual Internet Connection Setup** to manually configure your Network Camera and skip to "Network Setup" on page 26.

To quickly configure your Network Camera's motion detection settings, click **Motion Detection Setup Wizard**. If you want to enter your settings without running the wizard, click **Manual Motion Detection Setup** and skip to "Motion Detection" on page 36.

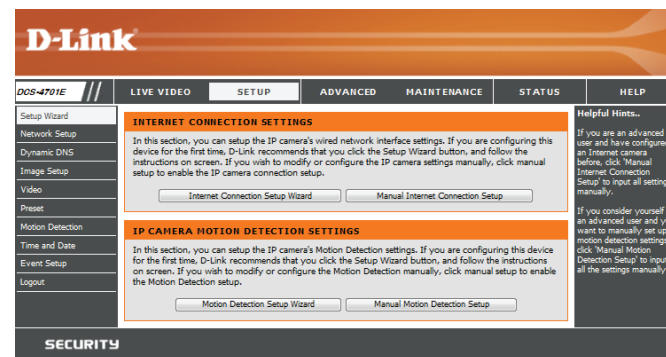

Internet Connection Setup Wizard

This wizard will guide you through a step-by-step process to configure your new D-Link Camera and connect the camera to the internet. Click **Next** to continue.

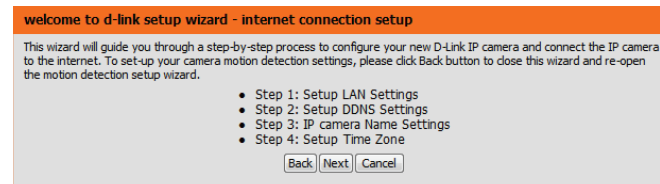

Select how the camera will connect to the Internet.

If your camera is connected to a router, or you are unsure how your camera will connect to the Internet, select DHCP Connection.

Select **Static IP** if your Internet Service Provider has provided you with connection settings, or if you wish to set a static address within your home network. Enter the correct configuration information and click **Next** to continue.

If you are using PPPoE, select **Enable PPPoE** and enter your user name and password.

Click **Next** to continue.

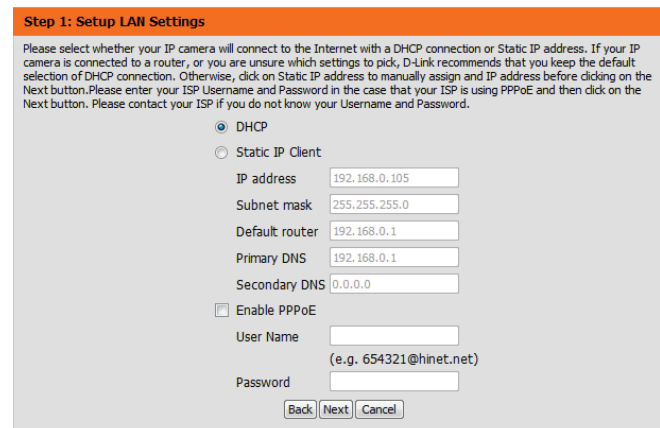

Section 3: Configuration

If you have a Dynamic DNS account and would like the camera to update your IP address automatically, Select **Enable DDNS** and enter your host information. Click **Next** to continue.

Step 2: Setup DDNS Settings

If you have a Dynamic DNS account and would like the IP camera to update your IP address automatically, enable DDNS and enter in your host information below. Please click on the Next button to continue.

Enable DDNS

Server Address <<

Host Name

User Name

Password

Verify Password

Timeout (hours)

Enter a name for your camera and click **Next** to continue.

Step 3: IP camera Name Settings

D-Link recommends that you rename your IP camera for easy accessibility. You can then identify and connect to your IP camera via this name. Please assign a name of your choice before clicking on the Next button.

IP camera Name

Configure the correct time to ensure that all events will be triggered as scheduled. Click **Next** to continue.

Step 4: Setup Time Zone

Please configure the correct time to ensure that all events are triggered, captured and scheduled at the correct time and day and then click on the Next button.

Time Zone

Enable Daylight Saving

If you have selected DHCP, you will see a summary of your settings, including the camera's IP address. Please write down all of this information as you will need it in order to access your camera.

Click **Apply** to save your settings.

Step 5: Setup complete

Below is a summary of your IP camera settings. Click on the Back button to review or modify settings or click on the Apply button if all settings are correct. It is recommended to note down these settings in order to access your IP camera on the network or via your web browser.

IP Address DHCP
IP camera Name DCS-4701E
Time Zone (UTC+08:00) Taipei
DDNS Disable
PPPoE Disable

Motion Detection Setup Wizard

This wizard will guide you through a step-by-step process to configure your camera's motion detection functions.

Click **Next** to continue.

Step 1

This step will allow you to enable or disable motion detection, specify the detection sensitivity, and adjust the camera's ability to detect movement.

You may specify whether the camera should capture a snapshot or a video clip when motion is detected.

Refer to "Motion Detection" on page 36 for information about how to configure motion detection.

Step 2

This step allows you to enable motion detection based on a customized schedule. Specify the day and hours. You may also choose to always record whenever motion is detected.

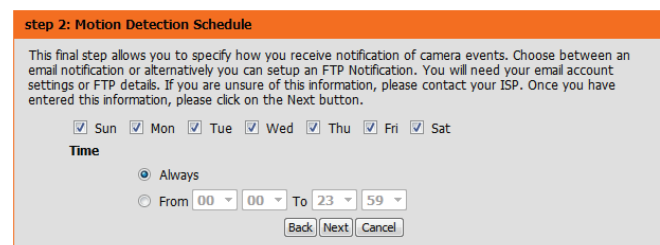
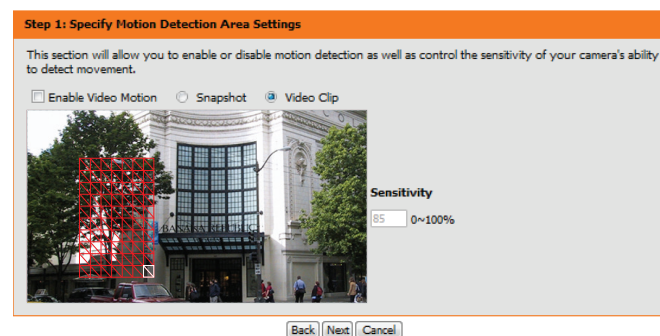
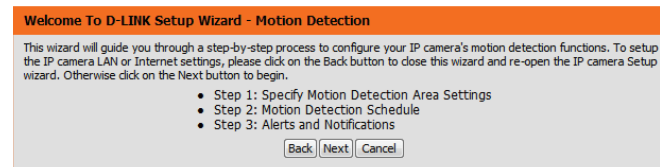

Section 3: Configuration

Step 3

This step allows you to specify how you will receive event notifications from your camera. You may choose not to receive notifications, or to receive notifications via e-mail or FTP.

Please enter the relevant information for your e-mail or FTP account.

Click **Next** to continue.

Step 3: Alerts and Notification

This final step allows you to specify how you receive notification of camera events. Choose between an email notification or alternatively you can setup an FTP Notification. You will need your email account settings or FTP details. If you are unsure of this information, please contact your ISP. Once you have entered this information, please click on the Next button.

Do not notify me

Email

Sender email address

Recipient email address

Server address

User name

Password

Port

This server requires a secure connection (StartTLS)

FTP

Server address

Port

User name

Password

Remote folder name

Step 4

You have completed the Motion Detection Wizard.

Please verify your settings and click **Apply** to save them.

Step 4: Setup Complete

You have completed your IP camera setup. Please click the Back button if you want to review or modify your settings or click on the Apply button to save and apply your settings.

Motion Detection : Enable

EVENT : Video Clip

Schedule Day : Sun , Mon , Tue , Wed , Thu , Fri , Sat ,

Schedule Time : Always

Alerts and Notification : Email

Please wait a few moments while the camera saves your settings and restarts.

Step 4: Setup Complete

You have completed your IP camera setup. Please click the Back button if you want to review or modify your settings or click on the Apply button to save and apply your settings.

Changes saved.IP camera's network is restarting, please wait for 6 seconds ...

Network Setup

Use this section to configure the network connections for your camera. All relevant information must be entered accurately. After making any changes, click the **Save Settings** button to save your changes.

LAN Settings: This section lets you configure settings for your local area network.

DHCP: Select this connection if you have a DHCP server running on your network and would like your camera to obtain an IP address automatically.

If you choose DHCP, you do not need to fill out the IP address settings.

Static IP Client: You may obtain a static or fixed IP address and other network information from your network administrator for your camera. A static IP address may simplify access to your camera in the future.

IP Address: Enter the fixed IP address in this field.

Subnet Mask: This number is used to determine if the destination is in the same subnet. The default value is 255.255.255.0.

Default Gateway: The gateway used to forward frames to destinations in a different subnet. Invalid gateway settings may cause the failure of transmissions to a different subnet.

Primary DNS: The primary domain name server translates names to IP addresses.

Secondary DNS: The secondary DNS acts as a backup to the primary DNS.

D-Link

DCS-4701E // LIVE VIDEO SETUP ADVANCED MAINTENANCE STATUS HELP

Setup Wizard
Network Setup
Dynamic DNS
Image Setup
Video
Preset
Motion Detection
Time and Date
Event Setup
Logout

NETWORK SETUP
You can configure your LAN and Internet settings here.
Save Settings Don't Save Settings

LAN SETTINGS

DHCP
 Static IP Client

IP address: 192.168.0.101
Subnet mask: 255.255.255.0
Default router: 192.168.0.1
Primary DNS: 192.168.0.1
Secondary DNS: 0.0.0.0

Enable UPnP presentation
 Enable UPnP port forwarding
Forwarding Port: 1024 [Edit]
Forwarding Status: UPnP forwarding is inactive

PPPOE SETTINGS

Enable Disable
User Name:
Password:
Confirm password:
PPPoE Status: PPPoE is inactive.

HTTP

HTTP port: 80
Access name for stream1: video1.mjpg
Access name for stream2: video2.mjpg
Access name for stream3: video3.mjpg

HTTPS

HTTPS port: 443

RTSP

Authentication: Digest
RTSP port: 554
Access name for stream1: live1.sdp
Access name for stream2: live2.sdp
Access name for stream3: live3.sdp

COS SETTINGS

Enable CoS
VLAN ID: 1 [0-4095]
Live video: 0
Live audio: 0
Event/Alarm: 0
Management: 0

QoS SETTINGS

Enable QoS
Live video: 0
Live audio: 0
Event/Alarm: 0
Management: 0

Helpful Hints...

Select DHCP Connection if you are running a DHCP server on your network and would like an IP address assigned to your IP camera automatically.

UPnP: Enabling UPnP settings will allow you to configure your IP camera as an UPnP device in the network.

PPPoE Settings: If you use the IP camera to connect directly to the Internet, you will need to enter the username and password, which were given to you when you set up your account with your Internet Service Provider. If the camera is behind a router or a gateway, you do not need to configure this setting.

HTTP: HTTP Port is the port you allocate in order to connect to the IP camera via a standard web browser.

HTTPS: HTTPS Port in a IP camera connects it with a PC via a secure web browser.

RTSP: RTSP Port is the port you allocate in order to connect to a IP camera by using streaming module device(s), such as a mobile phone or PDA.

CoS (Class of Service): Coarsely-grained traffic control based on the L2 protocol. Class of Service technologies do not guarantee a level of service in terms of bandwidth and delivery time, they offer a "best-effort".

QoS (Quality of Service): Finely-grained traffic control, a resource reservation control mechanism. Quality of service guarantees are important if the network capacity is insufficient, especially for real-time streaming multimedia applications.

Enable IPv6: Select this option and click Save to enable IPv6 setting. Please note that this only works if your network environment and hardware equipment support IPv6. The browser should be Microsoft's Internet Explorer 6.5, Mozilla Firefox 3.0 or above. When IPv6 is enabled, by default, the Network Camera will be listed to router advertisements and be assigned a link-local IPv6 address accordingly.

IPv6 Information: Click this button to obtain the IPv6 information. If your IPv6 setting was successful, the IPv6 address list will be listed in the pop-up window. Please follow the steps below to link to an IPv6.

Enable UPnP Presentation: Enabling this setting allows your camera to be configured as a UPnP device on your network.

Enable UPnP Port Forwarding: Enabling this setting allows the camera to add port forwarding entries into the router automatically on a UPnP capable network.

Enable PPPoE: Enable this setting if your network uses PPPoE.

User Name / Password: Enter the username and password for your PPPoE account. Re-enter your password in the Confirm Password field. You may obtain this information from your ISP.

HTTP Port: The default port number is 80.

Access Name for Stream 1~3: The default name is video#.mjpg, where # is the number of the stream.

HTTPS Port: You may use a PC with a secure browser to connect to the HTTPS port of the camera. The default port number is 443.

Authentication: Choose to enable or disable RTSP digest encryption. Digest encryption uses MD5 hashes.

RTSP Port: The port number that you use for RTSP streaming to mobile devices, such as mobile phones or PDAs. The default port number is 554. You may specify the address of a particular stream. For instance, live1.sdp can be accessed at rtsp://x.x.x.x/video1.sdp where the x.x.x.x represents the IP address of your camera.

Enable CoS: Enabling the Class of Service setting implements a best-effort policy without making any bandwidth reservations.

LAN SETTINGS

DHCP
 Static IP Client

IP address: 192.168.0.101
 Subnet mask: 255.255.255.0
 Default router: 192.168.0.1
 Primary DNS: 192.168.0.1
 Secondary DNS: 0.0.0.0

Enable UPnP presentation
 Enable UPnP port forwarding

Forwarding Port: 1024 [Test]
 Forwarding Status: UPnP forwarding is inactive

PPPOE SETTINGS

Enable Disable

User Name:
 Password:
 Confirm password:
 PPPoE Status: PPPoE is inactive.

HTTP

HTTP port: 80
 Access name for stream1: video1.mjpg
 Access name for stream2: video2.mjpg
 Access name for stream3: video3.mjpg

HTTPS

HTTPS port: 443

RTSP

Authentication: Digest
 RTSP port: 554
 Access name for stream1: live1.sdp
 Access name for stream2: live2.sdp
 Access name for stream3: live3.sdp

COS SETTINGS

Enable CoS

VLAN ID: 1 [0~4095]
 Live video: 0
 Live audio: 0
 Event/Alarm: 0
 Management: 0

QoS SETTINGS

Enable QoS

Live video: 0
 Live audio: 0
 Event/Alarm: 0
 Management: 0

Enable QoS: Enabling QoS allows you to specify a traffic priority policy to ensure a consistent Quality of Service during busy periods. If the Network Camera is connected to a router that itself implements QoS, the router's settings will override the QoS settings of the camera.

Enable IPv6: Enabling this setting will enable use of the IPv6 protocol. Click the IPv6 Information button to see the camera's current IPv6 details, or you can check **Manually setup the IP address** to manually set up the IP address, specify a default router, and set the primary DNS.

Enable Multicast for stream: The DCS-4701E allows you to multicast each of the available streams via group address and specify the TTL value for each stream. Enter the port and TTL settings you wish to use if you do not want to use the defaults.

Enable Bonjour: Enable this to allow other network devices to connect to this camera using Bonjour.

Bonjour Name: Enter the name to identify this camera on Bonjour.

QoS SETTINGS

Enable QoS

Live video	0	▼
Live audio	0	▼
Event/Alarm	0	▼
Management	0	▼

IPv6

Enable IPv6

IPv6 Information

 Manually setup the IP address

Optional IP address / Prefix length		/ 64
Optional default router		
Optional primary DNS		

MULTICAST

Enable multicast for stream 1

Multicast group address	239.1.1.1
Multicast video port	6550
Multicast RTCP video port	6551
Multicast audio port	6552
Multicast RTCP audio port	6553
Multicast TTL [1~255]	64

 Enable multicast for stream 2

Multicast group address	239.1.1.2
Multicast video port	6554
Multicast RTCP video port	6555
Multicast audio port	6556
Multicast RTCP audio port	6557
Multicast TTL [1~255]	64

 Enable multicast for stream 3

Multicast group address	239.1.1.3
Multicast video port	6558
Multicast RTCP video port	6559
Multicast audio port	6560
Multicast RTCP audio port	6561
Multicast TTL [1~255]	64

BONJOUR SETTINGS

Enable Bonjour

Bonjour Name	DCS-4701E_010001	32 characters maximum
(Characters you may use in a Bonjour Name: "upper or lower case letters", "numbers" and "hyphens".)		

D-Link DCS-4701E User Manual

28

Dynamic DNS

DDNS allows you to access your camera using a domain name instead of an IP address. To do this, you will need to have an account with one of the DDNS services listed in the drop-down box on this page.

Enable DDNS: Select this checkbox to enable the DDNS function.

Server Address: Select your Dynamic DNS provider from the pull down menu or enter the server address manually.

Host Name: Enter the host name of the DDNS server.

User Name: Enter the user name or e-mail used to connect to your DDNS account.

Password: Enter the password used to connect to your DDNS server account.

Timeout: Enter the DNS timeout values you wish to use.

Status: Indicates the connection status, which is automatically determined by the system.

D-Link

DCS-4701E // LIVE VIDEO SETUP ADVANCED MAINTENANCE STATUS HELP

Setup Wizard
Network Setup
Dynamic DNS
Image Setup
Video
Preset
Motion Detection
Time and Date
Event Setup
Logout

DYNAMIC DNS

The Dynamic DNS feature allows you to use a domain name that you have purchased (www.yourdomain.com) to access your IP camera with a dynamically assigned IP address. Most broadband Internet service providers assign dynamic (changing) IP addresses. By using a DDNS service, you can enter your domain name to connect to your IP camera no matter what your IP address is.

[Sign up for D-Link's Free DDNS service at www.DLinkDDNS.com](http://www.dlink.com)

Save Settings Don't Save Settings

DYNAMIC DNS SETTING

Enable DDNS

Server Address <<

Host Name

User Name

Password

Verify Password

Timeout (hours)

Status

Save Settings Don't Save Settings

Helpful Hint...
Dynamic DNS is useful if you have a DSL or Cable service provider that changes your modem IP address periodically. This will allow you to assign a website domain name to your IP camera instead of connecting through an IP address.

SECURITY

Image Setup

In this section, you may configure the video image settings for your camera. A preview of the image will be shown in Live Video.

Enable Privacy Mask: The Privacy Mask setting allows you to specify up to 3 rectangular areas on the camera's image to be blocked/excluded from recordings and snapshots.

You may click and drag the mouse cursor over the camera image to draw a mask area. Right clicking on the camera image brings up the following menu options:

- **Disable All:** Disables all mask areas
- **Enable All:** Enables all mask areas
- **Reset All:** Clears all mask areas.

Mirror: This will mirror the image horizontally.

Flip: This will flip the image vertically. When turning Flip on, you may want to consider turning Mirror on as well.

Anti Flicker: Select the frequency used by your power lines to avoid interference or distortion.

White Balance: Use the drop-down box to change white balance settings to help balance colors for different environments. You can choose from Auto, Outdoor, Indoor, Fluorescent, and Push Hold.

Exposure Mode: Changes the exposure mode. Use the drop-down box to set the camera for Indoor, Outdoor, or Night environments, or to Moving to capture moving objects. The Low Noise option will focus on creating a high-quality picture without noise. You can also create 3 different custom exposure modes. The Max Gain setting will allow you to control the maximum amount of gain to apply to brighten the picture.

Denoise: This setting controls the amount of noise reduction that will be applied to the picture.

Brightness: Adjust this setting to compensate for backlit subjects.

Contrast: Adjust this setting to alter the color intensity/strength.

Saturation: This setting controls the amount of coloration, from grayscale to fully saturated.

Sharpness: Specify a value from 0 to 8 to specify how much sharpening to apply to the image.

WDR Level: WDR makes it easier to see objects that may appear dark due to strong backlighting conditions during the daytime. Higher WDR levels will make it easier to see objects in shadows.

3D Filter: 3D filtering reduces the amount of image noise when viewing a low-light environment. Higher levels of 3D filtering will apply stronger levels of noise reduction.

Reset Default: Click this button to reset the image to factory default settings.

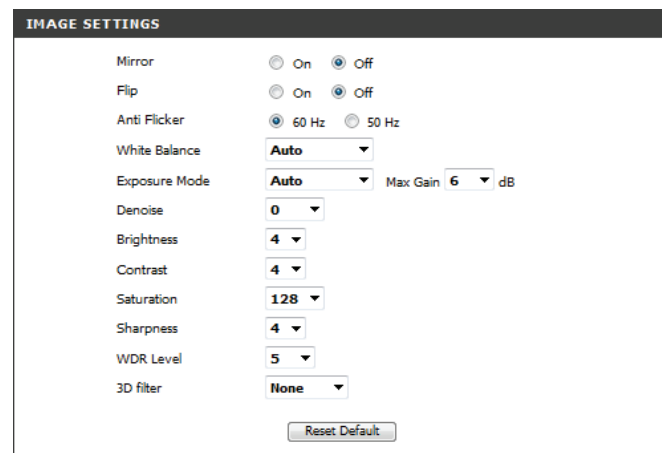

The screenshot displays the 'IMAGE SETTINGS' menu with the following options and values:

- Mirror: On Off
- Flip: On Off
- Anti Flicker: 60 Hz 50 Hz
- White Balance: Auto
- Exposure Mode: Auto Max Gain: 6 dB
- Denoise: 0
- Brightness: 4
- Contrast: 4
- Saturation: 128
- Sharpness: 4
- WDR Level: 5
- 3D filter: None

A 'Reset Default' button is located at the bottom right of the settings panel.

Video

You may configure up to 3 video profiles with different settings for your camera. Hence, you may set up different profiles for your computer and mobile display. After making any changes, click the **Save Settings** button to save your changes.

Aspect ratio: Set the aspect ratio of the video to 4:3 standard or 16:9 widescreen.

Mode: Set the video codec to be used to JPEG, MPEG-4, or H.264.

Frame size / View window area: Frame size determines the total capture resolution, and View window area determines the Live Video viewing window size. If the Frame size is larger than the Live Video size, you can use the ePTZ controls to look around.

16:9	1280 x 720, 800 x 448, 640 x 360, 480 x 272, 320 x 176 up to 30 fps
4:3	960 x 720, 800 x 592, 640 x 480, 320 x 240 up to 30 fps

Note: If your View window area is the same as your Frame size, you will not be able to use the ePTZ function.

Maximum frame rate: A higher frame rate provides smoother motion for videos, and requires more bandwidth. Lower frame rates will result in stuttering motion, and requires less bandwidth.

Video Quality: This limits the maximum frame rate, which can be combined with the "Fixed quality" option to optimize

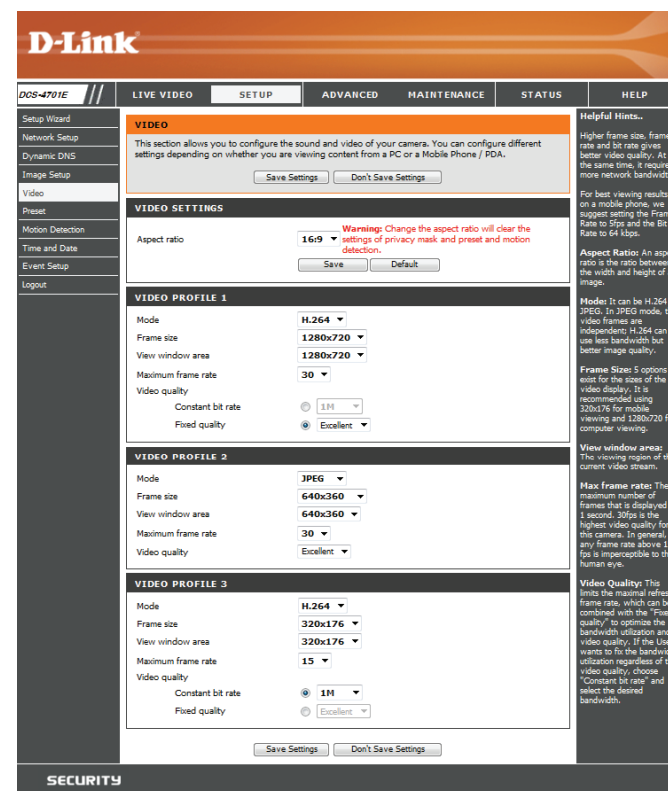

the bandwidth utilization and video quality. If fixed bandwidth utilization is desired regardless of the video quality, choose "Constant bit rate" and select the desired bandwidth.

Constant bit rate: The bps will affect the bit rate of the video recorded by the camera. Higher bit rates result in higher video quality.

Fixed quality: Select the image quality level for the camera to try to maintain. High quality levels will result in increased bit rates.

VIDEO PROFILE 1	
Mode	H.264
Frame size	1280x720
View window area	1280x720
Maximum frame rate	30
Video quality	
Constant bit rate	<input type="radio"/> 1M
Fixed quality	<input checked="" type="radio"/> Excellent

VIDEO PROFILE 2	
Mode	JPEG
Frame size	640x360
View window area	640x360
Maximum frame rate	30
Video quality	Excellent

VIDEO PROFILE 3	
Mode	H.264
Frame size	320x176
View window area	320x176
Maximum frame rate	15
Video quality	
Constant bit rate	<input checked="" type="radio"/> 1M
Fixed quality	<input type="radio"/> Excellent

Preset

This screen allows you to set preset points for the ePTZ function of the camera, which allows you to look around the camera's viewable area by using a zoomed view. Presets allow you to quickly go to and view a specific part of the area your camera is covering, and you can create preset sequences, which will automatically change the camera's view between the different presets according to a defined order and timing you can set.

Note: If your View window area is the same as your Frame size, you will not be able to use the ePTZ function.

Video Profile: This selects which video profile to use.

ePTZ Speed: You may select a value between 0 and 10. 0 is the slowest and 10 is the fastest.

Arrow Buttons and Home Button: Use these buttons to move to a specific part of the viewing area, which you can then set as a preset. Click the Home button to return to the center of the viewing area.

Input Preset Name: Enter the name of the preset you want to create, then click the **Add** button to make a new preset. If an existing preset has been selected from the Preset List, you can change its name by typing in a new name, then clicking the **Rename** button.

Preset List: Click this drop-down box to see a list of all the presets that have been created. You can select one, then click the **GoTo** button to change the displayed camera view to the preset. Clicking the **Remove** button will delete the currently selected preset.

Preset Sequence: This section allows you to create a preset sequence, which automatically moves the camera's view between a set of preset views.



Preset List: To add a preset to the sequence, select it from the drop-down box at the bottom of this window, set the **Dwell time** to determine how long the camera view will stay at that preset, then click the **Add** button. The preset name will appear in the list, followed by the dwell time to view that preset for.

You can rearrange your presets in the sequence by selecting a preset in the sequence, then clicking the arrow buttons to move it higher or lower in the current sequence.

Clicking the trash can button will remove the currently selected preset from the sequence.

If you want to change the dwell time for a preset, select it from the list, enter a new dwell time, then click the **Update** button.

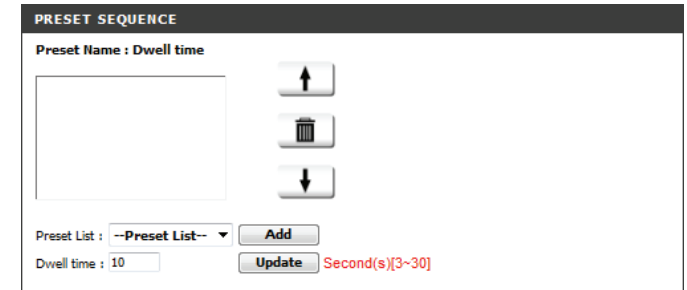

The screenshot shows a window titled "PRESET SEQUENCE". At the top, it says "Preset Name : Dwell time". Below this is a large empty rectangular box. To the right of this box are three vertically stacked buttons: an up arrow, a trash can, and a down arrow. At the bottom of the window, there is a "Preset List" dropdown menu currently showing "--Preset List--", an "Add" button, a "Dwell time" input field with the value "10", an "Update" button, and a red text label "Second(s)[3~30]".

Motion Detection

Motion detection enables the camera to monitor the video feed for movement. Here, you can adjust the sensitivity settings that determine whether motion is detected by the camera or not. After making any changes, click the **Save Settings** button to save your changes.

Enable Video Motion: Select this box to enable the motion detection feature of your camera.

Sensitivity: Specifies how sensitive motion detection will be from 0% to 100%. A low sensitivity setting means that there must be large changes between two images in order to detect motion, and a high sensitivity setting means that even small changes will cause motion to be detected.

Draw Motion Area: Use your mouse to click and drag on the areas that you would like to monitor for motion.

Erase Motion Area: To erase a motion detection area, simply click on the red square that you wish to remove.

Right click on the camera image to bring up the following menu options:

Select All: Draws a motion detection area over the entire screen.

Clear All: Clears any motion detection areas that have been drawn.

Restore: Restores the previously specified motion detection areas.

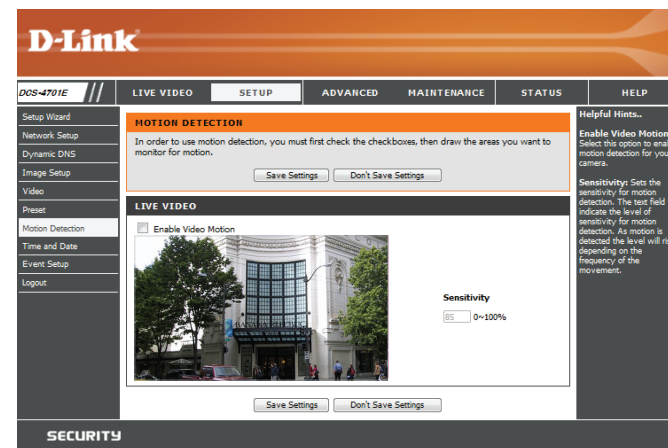

Time and Date

This section allows you to automatically or manually configure, update, and maintain the internal system clock for your camera. After making any changes, click the **Save Settings** button to save your changes.

Time Zone: Select your time zone from the drop-down menu.

Enable Daylight Saving: Select this to enable Daylight Saving Time.

Auto Daylight Saving: Select this option to allow your camera to configure the Daylight Saving settings automatically.

Set Date and Time Manually: Selecting this option allows you to configure the Daylight Saving date and time manually.

Offset: Sets the amount of time to be added or removed when Daylight Saving is enabled.

Synchronize with NTP Server: Enable this feature to obtain time automatically from an NTP server.

NTP Server: Network Time Protocol (NTP) synchronizes the DCS-4701E with an Internet time server. Choose the one that is closest to your location.

Set the Date and Time Manually: This option allows you to set the time and date manually.

Copy Your Computer's Time Settings: This will synchronize the time information from your PC.

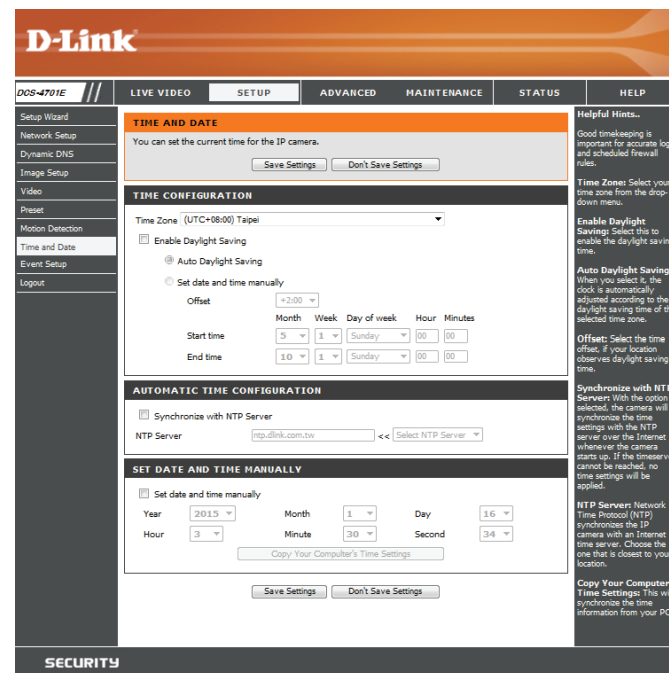

Event Setup

In a typical application, when motion is detected, the DCS-4701E sends images to a FTP server or via e-mail as notifications. As shown in the illustration below, an event can be triggered by many sources, such as motion detection. When an event is triggered, a specified action will be performed. You can configure the Network Camera to send snapshots or videos to your e-mail address or FTP site.

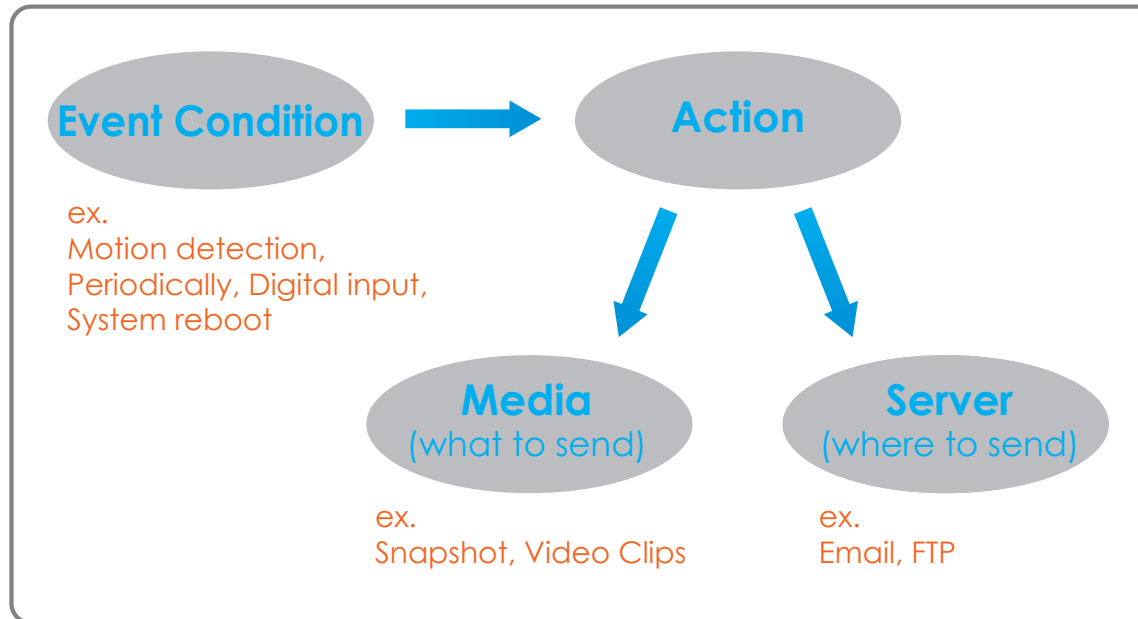

To start plotting an event, it is suggested to configure server and media columns first so that the Network Camera will know what action shall be performed when a trigger is activated.

The Event Setup page includes 4 different sections.

- Event
- Server
- Media
- Recording

1. To add a new item server, media, event, or recording item click **Add**. A screen will appear and allow you to update the fields accordingly.
2. To delete the selected item from the server, media, event, or recording drop-down menus, click the **Delete** button next to it.
3. Click on an item to edit it.

Add Server

You can configure up to 5 servers to save snapshots and/or video to. After making any changes, click the **Save Settings** button to save your changes.

Server Name: Enter the unique name of your server.

E-mail: Enter the configuration for the target e-mail server account.

FTP: Enter the configuration for the target FTP server account.

Network Storage: Specify a network storage device. Only one network storage device is supported.

Add Media

There are three types of media: **Snapshot**, **Video Clip**, and **System Log**. After making any changes, click the **Save Settings** button to save your changes.

Media Name: Enter a unique name for media type you want to create.

Snapshot: Select this option to set the media type to snapshots.

Source: Set the video profile to use as the media source. Refer to "Video" on page 32 for more information on video profiles.

Send pre-event image(s) [0~4]: Set the number of pre-event images to take. Pre-event images are images taken before the main event snapshot is taken.

Send post-event image(s) [0~7]: Set the number of post-event images to take. Post-event images are images taken after the main event snapshot is taken. You can set up to 7 post-event images to be taken.

For example:

If both the Send pre-event images and Send post-event images are set to four, a total of 9 images are generated after a trigger is activated.

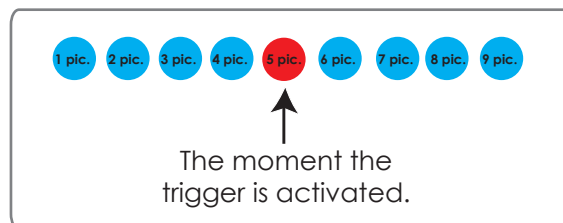

File name prefix: The prefix name will be added to the file name.

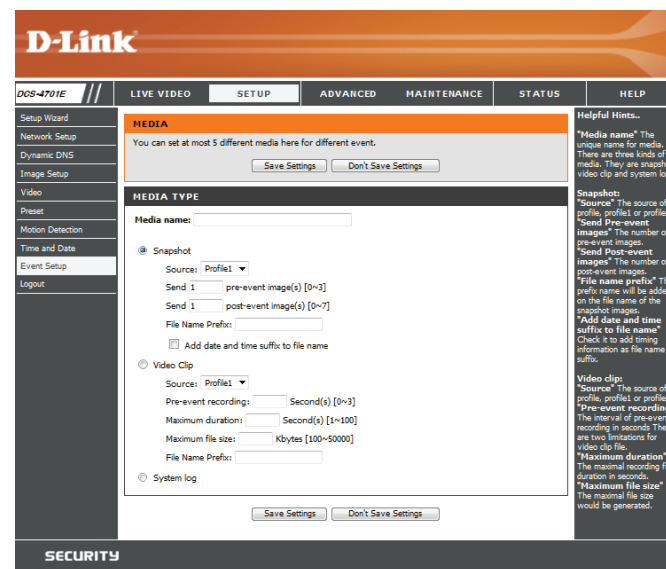

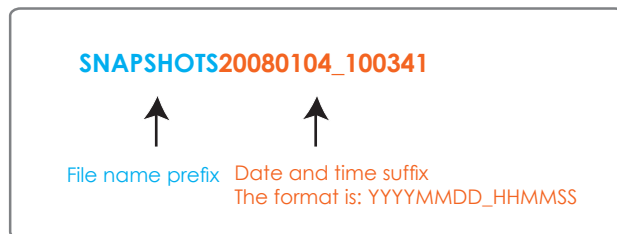

Add date and time suffix to file name: Check this to add the date and time the snapshot was recorded as a file name suffix.

Video clip: Select this option to set the media type to video clips.

Source: Set the video profile to use as the media source. Refer to "Video" on page 32 for more information on video profiles.

Pre-event recording: This sets how many seconds to record before the main event video clip starts. You can record up to 4 seconds of pre-event video.

Maximum duration: Set the maximum length of video to record for your video clips.

Maximum file size: Set the maximum file size to record for your video clips.

File Name Prefix: This is the prefix that will be added to the filename of saved video clips.

System log: Select this option to set the media type to system logs. This will save the event to the camera system log, but will not record any snapshots or video.

MEDIA TYPE

Media name:

Snapshot

Source: Profile1

Send 1 pre-event image(s) [0~3]

Send 1 post-event image(s) [0~7]

File Name Prefix:

Add date and time suffix to file name

Video Clip

Source: Profile1

Pre-event recording: Second(s) [0~3]

Maximum duration: Second(s) [1~100]

Maximum file size: Kbytes [100~50000]

File Name Prefix:

System log

Save Settings Don't Save Settings

Add Event

Create and schedule up to 3 events with their own settings here. After making any changes, click the **Save Settings** button to save your changes.

Event name: Enter a name for the event.

Enable this event: Select this box to activate this event.

Priority: Set the priority for this event. The event with higher priority will be executed first.

Delay: Select the delay time before checking the next event. It is being used for both events of motion detection and digital input trigger.

Trigger: Specify the input type that triggers the event.

Video Motion Detection: Motion is detected during live video monitoring. Select the windows that need to be monitored.

Periodic: The event is triggered in specified intervals. The trigger interval unit is in minutes.

System Boot: Triggers an event when the system boots up.

Network Lost: Triggers an event when the network connection is lost.

Time: Select **Always** or enter the time interval to monitor for the specified kind of event.

Action: If you have created Server and Media entries, you will see them appear here. Select which Server you want to send to and which Media you want the camera to send.

D-Link

DCS-4701E // LIVE VIDEO SETUP ADVANCED MAINTENANCE STATUS HELP

EVENT

You can set at most 2 events like motion detection or digital input trigger here and arrange the detection schedule at the same time.

Save Settings Don't Save Settings

EVENT

Event name:

Enable this event

Priority: normal

Delay for: 10 seconds before detecting next event [For motion detection]

TRIGGER

Video motion detection

Periodic

Trigger every 1 minutes

System boot

Network lost

EVENT SCHEDULE

Sun Mon Tue Wed Thu Fri Sat

Time

Always

From 00:00 To 23:59

ACTION

Save to e-mail

Attached media: Save snapshot

Save Settings Don't Save Settings

Helpful Hints...

Priority: The event with higher priority will be executed first.

There are five kinds of trigger supported.

Video motion detection: Select the windows which need to be monitored.

Periodic: The event is triggered in specified intervals. The unit of trigger interval is minute.

System boot: The event is triggered when the system boot up.

Network lost: The event is triggered when the network service is not available or disconnection.

Sun ~ Sat: Select the days of the week to perform the event.

Times show "Always" or input the time interval.

Note: Please Format SD card before use. The entire data in the SD card will be erased after formatting.

SECURITY

Add Recording

Here you can configure and schedule the recording settings. After making any changes, click the **Save Settings** button to save your changes.

Recording entry name: Enter a name for the recording.

Enable this recording: Select this to enable the recording function.

Priority: Set the priority for this entry. An entry with a higher priority value will be executed first.

Source: Select the video profile to use as the recording source.

Recording schedule: Use the checkboxes to set which days to record video on. Select **Always** to record for the entire day, or select **From** and select what period of time you want to record using the dropdown boxes.

Destination: Select the folder where the recording file will be stored.

Total cycling recording size: Please input a HDD volume between 1MB and 2TB for recording space. The recording data will replace the oldest record when the total recording size exceeds this value. For example, if each recording file is 6MB, and the total cyclical recording size is 600MB, then the camera will record 100 files in the specified location (folder) and then will delete the oldest file and create new file for cyclical recording.

Please note that if the free HDD space is not enough, the recording will stop. Before you set up this option please make sure your HDD has enough space, and it is better to not save other files in the same folder as recording files.

D-Link

DCS-4701E // LIVE VIDEO SETUP ADVANCED MAINTENANCE STATUS HELP

RECORDING

You can setup schedule recording to network storage with your specify week day and time period.

Save Settings Don't Save Settings

RECORDING

Recording entry name:

Enable this recording

Priority: normal

Source: Profile 1

RECORDING SCHEDULE

Sun Mon Tue Wed Thu Fri Sat

Time

Always

From : To :

RECORDING SETTINGS

Destination: None

Total cycling recording size: 1000 Mbytes [200~2000000]

Size of each file for recording: 10 Mbytes

Time of each file for recording: 1.0 seconds

File Name Prefix:

Save Settings Don't Save Settings

Helpful Hints...

Recording: Enable this option if you want to upload the recording to a shared folder on the network.

Recording schedule: Select the day(s) according to when you want the IP camera to make a video clip.

Always: This enables the IP camera to make video clips continuously.

From: The time range specified for the video clip.

Total cycling recording size: Please enter the maximum amount of storage that can be used for recording on the media. Files will be written to storage cyclically (eg. oldest files will be overwritten if necessary) so that the total recording size does not exceed this value.

Note: Please Format SD card before use. The entire data in the SD card will be erased after formatting.

SECURITY

Size of each file for recording: If this is selected, files will be separated based on the file size you specify.

Time of each file for recording: If this is selected, files will be separated based on the maximum length you specify.

File Name Prefix: The prefix name will be added on the file name of the recording file(s).

The screenshot displays a configuration interface for recording, divided into three main sections:

- RECORDING:** Contains a text field for "Recording entry name", a checkbox for "Enable this recording", a "Priority" dropdown menu set to "normal", and a "Source" dropdown menu set to "Profile 1".
- RECORDING SCHEDULE:** Features a row of checkboxes for days of the week (Sun, Mon, Tue, Wed, Thu, Fri, Sat), all of which are checked. Below this is a "Time" section with a radio button selected for "Always" and another radio button for "From" followed by two time input fields (00:00) and "To" followed by two time input fields (23:59).
- RECORDING SETTINGS:** Includes a "Destination" dropdown menu set to "None", a "Total cycling recording size" field set to "1000" Mbytes, and two radio buttons: "Size of each file for recording" (selected) set to "10" Mbytes, and "Time of each file for recording" set to "10" seconds. A "File Name Prefix" text field is also present.

At the bottom of the interface are two buttons: "Save Settings" and "Don't Save Settings".

Advanced ICR and IR

Here you can configure the ICR and IR settings. The IR (Infrared) Cut-Removable (ICR) filter can be disengaged for increased sensitivity in low light environments.

Automatic: The Day/Night mode is set automatically. You can use the Sensitivity drop-down box to set when the camera will switch to Night mode. The text box to the right shows what lighting conditions are currently being detected by the camera for reference. You can refresh this status by clicking the **Refresh** button.

Day Mode: Day mode enables the IR Cut Filter.

Night Mode: Night mode disables the IR Cut Filter.

Schedule Mode: Set up the Day/Night mode using a schedule. The camera will enter Day mode at the starting time and return to Night mode at the ending time.

IR Light Control: The camera can enable or disable the IR (infrared) light according to your preferences. This setting provides additional controls depending on your specific application.

Off: The IR light will always be off.

On: The IR light will always be on.

Sync with ICR: The IR light will turn on when the ICR filter is disabled (night mode).

Schedule: The IR light will turn on or off according to the schedule that you specify below.



HTTPS

This page allows you to install and activate an HTTPS certificate for secure access to your camera. After making any changes, click the **Save Settings** button to save your changes.

Enable HTTPS Secure Connection: Enable the HTTPS service.

Create Certificate Method: Choose the way the certificate should be created. Three options are available:

- Create a self-signed certificate automatically
- Create a self-signed certificate manually
- Create a certificate request and install

Status: Displays the status of the certificate.

Note: The certificate cannot be removed while HTTPS is still enabled. To remove the certificate, you must first uncheck **Enable HTTPS secure connection**.



Access List

Here you can set access permissions for users to view your DCS-4701E.

Allow list: The list of IP addresses that have access rights to the camera.

Note: When adding entries to the Allow list, make sure the first entry includes the IP address of the computer or device you are using to access the camera. Otherwise, you may be blocked from accessing the camera after adding the entry to the Allow list.

Start IP address: The starting IP address of the IP address range for the devices (such as a computer) that have permission to access the video of the camera.

End IP address: The ending IP address of the IP address range for the devices (such as a computer) that have permission to access the video of the camera. Click **Add** to save your changes.

Note: A total of seven lists can be configured for both columns.

Delete allow list: Select an entry to remove from the Allow List, then click **Delete**.

Deny list: The list of IP addresses that have no access rights to the camera.

Delete deny list: Select an entry to remove from the Deny List, then click **Delete**.

Note: All addresses in the Deny List will be denied access, even if they are also in the Allow List.



SNMP

Here you can set the SNMP settings for the camera, which allow for SNMP management of the camera.

Enable SMNPv1, SNMPv2c: Enable this option to allow for SNMPv1 and SNMPv2c management of the camera.

Read/Write Community: Enter a name for the read/write community of your SNMP server.

Read Only Community: Enter a name for the read-only community of your SNMP server.

Enable SNMPv3: Enable this option to allow SNMPv3 management of the camera.

Read/Write Security Name: Enter a name for the read/write community of your read/write SNMP server.

Authentication Type: Enter the type of authentication used by your read/write SNMP server.

Authentication Password: Enter the authentication password used for your read/write SNMP server.

Encryption Password: Enter the encryption password used for your read/write SNMP server.

Read Only Security Name Enter a name for the read-only community of your read-only SNMP server.

D-Link

DCS-4701E // LIVE VIDEO SETUP ADVANCED MAINTENANCE STATUS HELP

ICR and IR
HTTPS
Access List
SNMP
Logout

SNMP

The Simple Network Management Protocol is an application layer protocol that facilitates the exchange of management information between network devices. It helps network administrators to remotely manage network devices and find, solve network problems with ease.

Save Settings Don't Save Settings

SNMP CONFIGURATION

Enable SNMPv1, SNMPv2c

Read/Write community private

Read only community public

Enable SNMPv3

Read/Write Security name private

Authentication type SHA

Authentication password *****

Encryption password *****

Read only security name public

Authentication type SHA

Authentication password *****

Encryption password *****

Save Settings Don't Save Settings

Helpful Hints...

Enable SNMPv1, SNMPv2c: Select this option and enter the names of Read/Write community and Read Only community according to your NMS setting.

Enable SNMPv3: This option contains cryptographic security, a higher security level which allows you to set the Authentication password and the Encryption password.

Security name: According to your NMS setting, choose Read/Write or Read Only and enter the community name.

Authentication type: Select MD5 or SHA as the authentication method.

Authentication password: Enter the password for authentication (at least 8 characters).

Encryption password: Enter a password for encryption (at least 8 characters).

SECURITY

Authentication Type: Enter the type of authentication used by your read-only SNMP server.

Authentication Password: Enter the authentication password used for your read-only SNMP server.

Encryption Password: Enter the encryption password used for your read-only SNMP server.

The image shows a web-based configuration interface titled "SNMP CONFIGURATION". It contains two sections for enabling and configuring SNMP protocols. The first section, "Enable SNMPv1, SNMPv2c", has a checked checkbox and two text input fields: "Read/Write community" with the value "private" and "Read only community" with the value "public". The second section, "Enable SNMPv3", also has a checked checkbox and four fields: "Read/Write Security name" (private), "Authentication type" (SHA), "Authentication password" (masked with asterisks), "Encryption password" (masked with asterisks), "Read only security name" (public), "Authentication type" (SHA), "Authentication password" (masked with asterisks), and "Encryption password" (masked with asterisks). At the bottom of the form are two buttons: "Save Settings" and "Don't Save Settings".

Maintenance

Device Management

You may modify the name and administrator's password of your camera, as well as add and manage the user accounts for accessing the camera. You may also use this section to create a unique name and configure the OSD settings for your camera.

Admin Password Setting: Set a new password for the administrator's account.

Add User Account: Add a new user account.

User Name: Enter the user name for the new account.

Password: Enter the password for the new account.

User List: All the existing user accounts will be displayed here. You may delete accounts included in the list, but you may want to reserve at least one as a guest account.

IP Camera Name: Create a unique name for your camera that will be added to the file name prefix when creating a snapshot or a video clip.

Enable OSD: Select this option to enable the On-Screen Display feature for your camera.

Label: Enter a label for the camera, which will be shown on the OSD when it is enabled.

Show Time: Select this option to enable the time-stamp display on the video screen.

LED: You may specify whether or not to illuminate the status LED on the camera.

D-Link

DCS-4701E // LIVE VIDEO SETUP ADVANCED MAINTENANCE STATUS HELP

Admin
System
Firmware Upgrade
Logout

ADMIN
Here you can change the administrator's password for your IP camera as well as add and/or delete user account(s). You can configure the information, such as IP camera's name and time via this page. You can also enable the OSD (On-Screen Display) feature in order to display the IP camera name and time stamp for your video recordings.

ADMIN PASSWORD SETTING

New Password 32 characters maximum
Retype Password

ADD USER ACCOUNT

User Name 20 users maximum
New Password 32 characters maximum
Retype Password

USER LIST

User Name -- User list --

DEVICE SETTING

IP Camera Name DCS-4701E 63 characters maximum
 Enable OSD
Label DCS-4701E 30 characters maximum
Show Time

LED

LED On Off

Helpful Hints...
Enabling OSD, the IP camera name and time will be displayed on the video screen for the user.
For security purposes, it is recommended that you change the password for your administrator account. Be sure to write down the new password to avoid having to reset the IP camera in the event that it is forgotten.
LED: In the near panel of your camera there is a LED beside the network adapter. ON: The LED will flash in light to indicate if the network is working or not. OFF: No light will show. Forth option is turn off.

SECURITY

System

In this section, you may backup, restore and reset the camera configuration, or reboot the camera.

Save To Local Hard Drive: You may save your current camera configuration as a file on your computer.

Load From Local Hard Drive: Locate a pre-saved configuration by clicking **Browse** and then restore the pre-defined settings to your camera by clicking **Load Configuration**.

Restore to Factory Defaults: You may reset your camera and restore the factory settings by clicking **Restore Factory Defaults**.

Reboot Device: This will restart your camera.

Enable Schedule Reboot: If you want your camera to reboot on a regular schedule, check the **Enable Schedule Reboot** checkbox, then select the days and time you want the camera to reboot on.



Firmware Upgrade

The camera's current firmware version will be displayed on this screen. You may visit the D-Link Support Website to check for the latest available firmware version.

To upgrade the firmware on your DCS-4701E, please download and save the latest firmware version from the D-Link Support Page to your local hard drive. Locate the file on your local hard drive by clicking the **Browse** button. Select the file and click the **Upload** button to start upgrading the firmware.

Current Firmware Version: Displays the detected firmware version.

Current Product Name: Displays the camera model name.

File Path: Locate the file (upgraded firmware) on your hard drive by clicking **Browse**.

Upload: Uploads the new firmware to your camera.



Status

Device Info

This page displays detailed information about your device and network connection.

The screenshot shows the D-Link web interface for the DCS-4701E camera. The top navigation bar includes 'LIVE VIDEO', 'SETUP', 'ADVANCED', 'MAINTENANCE', 'STATUS', and 'HELP'. The 'STATUS' tab is selected. On the left, a sidebar contains 'Device Info', 'Log', and 'Logout'. The main content area is titled 'DEVICE INFO' and contains a message: 'All of your network connection details are displayed on this page. The firmware version is also displayed here.' Below this is an 'INFORMATION' table with the following data:

INFORMATION	
IP Camera Name	DCS-4701E
Time & Date	Fri Jan 16 03:34:49 2015
Firmware Version	0.02.01
Hardware Version	A
MAC Address	0A:00:47:01:00:01
IP Address	192.168.0.101
IP Subnet Mask	255.255.255.0
Default Gateway	192.168.0.1
Primary DNS	192.168.0.1
Secondary DNS	0.0.0.0
PPPoE	Disable
DDNS	Disable

On the right side, there is a 'Helpful Hints..' section with the text: 'This page displays all the information about the IP camera and network settings.'

Logs

This page displays the log information of your camera. You may download the information by clicking **Download**. You may also click **Clear** to delete the saved log information.

The screenshot shows the D-Link web interface for the DCS-4701E camera. The top navigation bar includes 'LIVE VIDEO', 'SETUP', 'ADVANCED', 'MAINTENANCE', 'STATUS', and 'HELP'. The 'STATUS' tab is selected, and the 'Log' option is chosen in the left sidebar. The main content area is titled 'SYSTEM LOG' and contains a description: 'The system log records IP camera events that have occurred.' Below this is the 'CURRENT LOG' section, which lists 20 log entries. At the bottom of the log list are navigation buttons: 'First Page', 'Previous 20', 'Next 20', 'Clear', and 'Download'. A 'Helpful Hints..' section on the right explains that users can save logs to their local hard drive by clicking 'Download' and clear them by clicking 'Clear'.

Device Info	SYSTEM LOG	Helpful Hints..
Log	The system log records IP camera events that have occurred.	You can save the log to your local hard IP camera by clicking the Download button, and you can clear the log by clicking on the Clear button.
Logout	<p>CURRENT LOG</p> <ol style="list-style-type: none"> 2015-01-16 03:34:01 admin FROM 192.168.0.174 DELETE RECORDING 1 2015-01-16 03:33:19 admin FROM 192.168.0.174 TURN ON RECORDING 1 to None ; Name : Night Recording 2015-01-16 03:33:19 admin FROM 192.168.0.174 SET Size of each file for recording 10 Mbytes 2015-01-16 03:32:06 admin FROM 192.168.0.174 SET EVENT TYPE 1 ; Trigger : Motion Detection 2015-01-16 03:31:45 admin FROM 192.168.0.174 SET EVENT MEDIA 2 ; Name : Save to log, Type : System log 2015-01-16 03:31:36 admin FROM 192.168.0.174 SET EVENT MEDIA 1 ; Name : Save snapshot, Type : Snapshot 2015-01-16 03:31:22 admin FROM 192.168.0.174 SET EVENT SERVER 1 ; Name : Save to e-mail, Type : Email 2015-01-16 02:45:17 admin FROM 192.168.0.174 LOGIN OK 2015-01-16 02:45:15 DCS-4701E ACQUIRE DHCP IP 192.168.0.101 2015-01-16 02:45:14 NETWORK RECONNECT 2015-01-16 00:41:22 NETWORK LOSS 2015-01-15 23:29:54 admin FROM 192.168.0.174 SET VIDEO CODEC Need Reset 2015-01-15 23:29:48 admin FROM 192.168.0.174 SET PROFILE 3 FRAMERATE 15 2015-01-15 23:29:48 admin FROM 192.168.0.174 SET PROFILE 3 Viewer window area 320x176 2015-01-15 23:29:48 admin FROM 192.168.0.174 SET PROFILE 3 Frame Size 320x176 2015-01-15 23:28:57 admin FROM 192.168.0.174 LOGIN OK 2015-01-15 17:28:39 SYSTEM SET IR LIGHT OFF 2015-01-15 17:28:39 SYSTEM SET IR LIGHT ON 2015-01-15 17:28:39 SYSTEM SET IR LIGHT ON 2015-01-15 06:59:31 SYSTEM SET IR LIGHT ON <p>First Page Previous 20 Next 20</p> <p>Clear Download</p>	

SECURITY

Help

This page provides helpful information regarding camera operation.

The screenshot shows the D-Link DCS-4701E web interface. At the top is the D-Link logo. Below it is a navigation bar with tabs for LIVE VIDEO, SETUP, ADVANCED, MAINTENANCE, STATUS, and HELP. The HELP tab is selected. On the left side, there is a sidebar with 'Help' and 'Logout' links. The main content area is titled 'HELP' and contains a list of links organized into sections: LIVE VIDEO (Camera), SETUP (Setup Wizard, Network Setup, Dynamic DNS, Image Setup, Audio and Video, Preset, Motion Detection, Time and Date, Event Setup), ADVANCED (ICR and IR, HTTPS, Access List, SNMP), MAINTENANCE (Admin, System, Firmware Upgrade), and STATUS (Device Info, Log). At the bottom of the page, there is a 'SECURITY' section.

D-Link

DCS-4701E // LIVE VIDEO SETUP ADVANCED MAINTENANCE STATUS HELP

Help
Logout

HELP

- [LIVE VIDEO](#)
- [SETUP](#)
- [MAINTENANCE](#)
- [ADVANCED](#)
- [STATUS](#)

LIVE VIDEO

- [Camera](#)

SETUP

- [Setup Wizard](#)
- [Network Setup](#)
- [Dynamic DNS](#)
- [Image Setup](#)
- [Audio and Video](#)
- [Preset](#)
- [Motion Detection](#)
- [Time and Date](#)
- [Event Setup](#)

ADVANCED

- [ICR and IR](#)
- [HTTPS](#)
- [Access List](#)
- [SNMP](#)

MAINTENANCE

- [Admin](#)
- [System](#)
- [Firmware Upgrade](#)

STATUS

- [Device Info](#)
- [Log](#)

SECURITY

Technical Specifications

Camera	Camera Hardware Profile	<ul style="list-style-type: none"> ▪ 1/3" 1.3 Megapixel progressive CMOS sensor ▪ 30 meter IR illumination distance ▪ Minimum illumination: 0 lux with IR LED on ▪ Built-in Infrared-Cut Removable (ICR) Filter module ▪ 10x digital zoom ▪ Minimum object distance 0.2M 	<ul style="list-style-type: none"> ▪ Focal length: 2.8 mm ▪ Aperture: F1.8 ▪ Angle of view: <ul style="list-style-type: none"> ▪ (H) 96° ▪ (V) 54° ▪ (D) 108°
	Camera Housing	<ul style="list-style-type: none"> ▪ IP-66 compliant weatherproof housing 	
	Image Features	<ul style="list-style-type: none"> ▪ Configurable image size, quality, frame rate, and bit rate ▪ Time stamp and text overlays ▪ Configurable motion detection windows 	<ul style="list-style-type: none"> ▪ Configurable privacy mask zones ▪ Configurable shutter speed, brightness, saturation, contrast, and sharpness
	Video Compression	<ul style="list-style-type: none"> ▪ Simultaneous H.264/MJPEG format compression ▪ H.264/MJPEG multicast streaming 	<ul style="list-style-type: none"> ▪ JPEG for still images
	Video Resolution	16:9 - 1280 x 720, 800 x 448, 640 x 360, 480 x 272, 320 x 176 up to 30 fps	4:3 - 960 x 720, 800 x 592, 640 x 480, 480 x 352, 320 x 240 up to 30 fps
	External Device Interface	<ul style="list-style-type: none"> ▪ 10/100 BASE-TX Fast Ethernet port 	<ul style="list-style-type: none"> ▪ Supports 802.3af PoE
Network	Network Protocols	<ul style="list-style-type: none"> ▪ IPv6 ▪ IPv4 ▪ TCP/IP ▪ UDP ▪ ICMP ▪ DHCP client ▪ NTP client (D-Link) ▪ DNS client ▪ DDNS client (D-Link) ▪ SMTP client ▪ FTP client 	<ul style="list-style-type: none"> ▪ HTTP / HTTPS ▪ Samba client ▪ PPPoE ▪ UPnP port forwarding ▪ RTP / RTSP / RTCP ▪ IP filtering ▪ QoS ▪ CoS ▪ Multicast ▪ IGMP ▪ ONVIF compliant
	Security	Administrator and user group protection Password authentication	HTTP and RTSP authentication

Appendix A: Technical Specifications

System Management	System Requirements for Web Interface	<ul style="list-style-type: none"> Browser: Internet Explorer, Firefox, Chrome, Safari 	
	Event Management	<ul style="list-style-type: none"> Motion detection Event notification and uploading of snapshots/video clips via e-mail or FTP 	<ul style="list-style-type: none"> Supports multiple SMTP and FTP servers Multiple event notifications Multiple recording methods for easy backup
	Remote Management	<ul style="list-style-type: none"> Take snapshots/video clips and save to local hard drive 	<ul style="list-style-type: none"> Configuration interface accessible via web browser
	D-ViewCam™ System Requirements	<ul style="list-style-type: none"> Operating System: Microsoft Windows 8/7/Vista Web Browser: Internet Explorer 7 or higher 	<ul style="list-style-type: none"> Protocol: Standard TCP/IP
	D-ViewCam™ Software Functions	<ul style="list-style-type: none"> Remote management/control of up to 32 cameras Viewing of up to 32 cameras on one screen 	<ul style="list-style-type: none"> Supports all management functions provided in web interface Scheduled motion triggered, or manual recording options
General	Weight	445 g ± 5%	
	External Power Adapter (not included)	Input: 100 to 240 V AC, 50/60 Hz	Output: 12 V DC 1.5 A
	Power Consumption	4.7 watts ± 5%	
	Temperature	Operating: -30 to 50 °C (-22 to 122 °F)	Storage: -20° to 70° C (-4° to 158° F)
	Humidity	Operating: 20% to 80% non-condensing	Storage: 5% to 95% non-condensing
	Certifications	CE CE LVD	FCC C-Tick

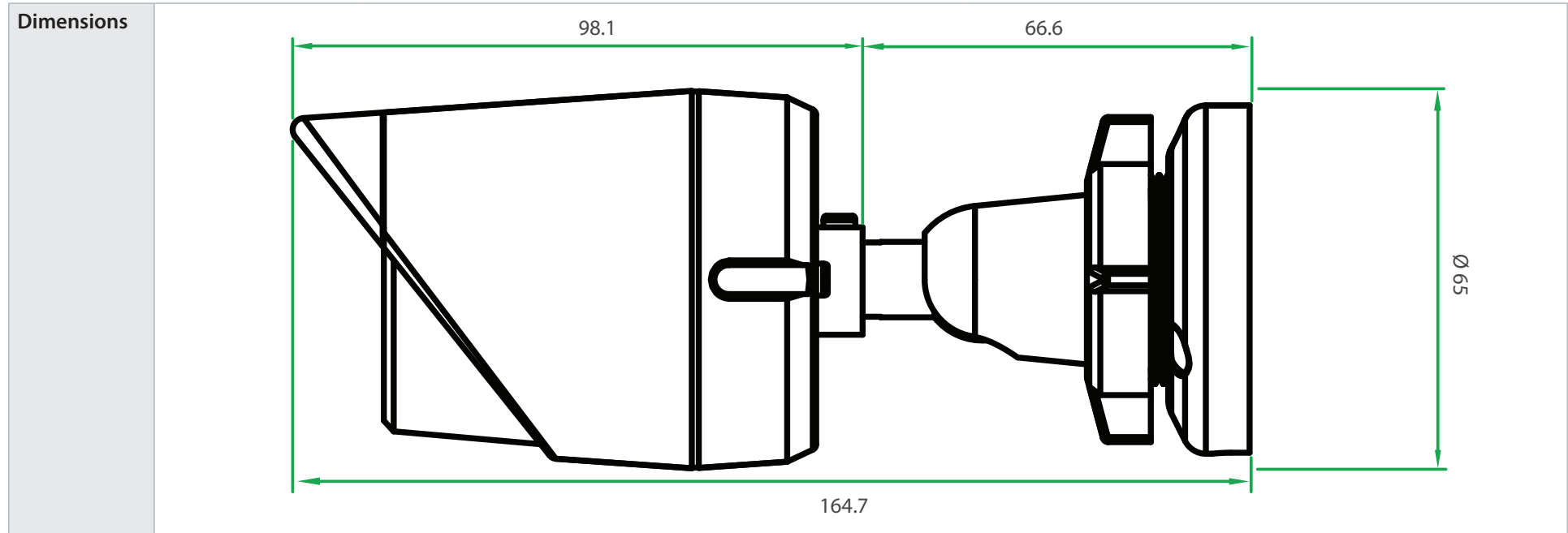

Regulatory Information

Federal Communication Commission Interference Statement:

This equipment has been tested and found to comply with the limits for a Class A digital device, pursuant to part 15 of the FCC Rules. These limits are designed to provide reasonable protection against harmful interference when the equipment is operated in a commercial environment. This equipment generates, uses, and can radiate radio frequency energy and, if not installed and used in accordance with the instruction manual, may cause harmful interference to radio communications. Operation of this equipment in a residential area is likely to cause harmful interference in which case the user will be required to correct the interference at his own expense.

Non-modification Statement:

Any changes or modifications not expressly approved by the party responsible for compliance could void the user's authority to operate this equipment.

Caution:

This device complies with Part 15 of the FCC Rules. Operation is subject to the following two conditions: (1) This device may not cause harmful interference, and (2) this device must accept any interference received, including interference that may cause undesired operation.

Industry Canada Statement:

This Class A digital apparatus complies with Canadian ICES-003.

Cet appareil numérique de la classe A est conforme à la norme NMB-003 du Canada.

European Union

CE EMI Class A Warning



This equipment is compliant with Class A of CISPR 32. In a residential environment this equipment may cause radio interference.

SAFETY INSTRUCTIONS

The following general safety guidelines are provided to help ensure your own personal safety and protect your product from potential damage. Remember to consult the product user instructions for more details.

- Static electricity can be harmful to electronic components. Discharge static electricity from your body (i.e. touching grounded bare metal) before touching the product.
- Do not attempt to service the product and never disassemble the product. For some products with a user replaceable battery, please read and follow the instructions in the user manual.
- Do not spill food or liquid on your product and never push any objects into the openings of your product.
- Do not use this product near water, areas with high humidity, or condensation unless the product is specifically rated for outdoor application.
- Keep the product away from radiators and other heat sources.
- Always unplug the product from mains power before cleaning and use a dry lint free cloth only.

SICHERHEITSVORSCHRIFTEN

Die folgenden allgemeinen Sicherheitsvorschriften dienen als Hilfe zur Gewährleistung Ihrer eigenen Sicherheit und zum Schutz Ihres Produkts. Weitere Details finden Sie in den Benutzeranleitungen zum Produkt.

- Statische Elektrizität kann elektronischen Komponenten schaden. Um Schäden durch statische Aufladung zu vermeiden, leiten Sie elektrostatische Ladungen von Ihrem Körper ab, (z. B. durch Berühren eines geerdeten blanken Metallteils), bevor Sie das Produkt berühren.
- Unterlassen Sie jeden Versuch, das Produkt zu warten, und versuchen Sie nicht, es in seine Bestandteile zu zerlegen. Für einige Produkte mit austauschbaren Akkus lesen Sie bitte das Benutzerhandbuch und befolgen Sie die dort beschriebenen Anleitungen.
- Vermeiden Sie, dass Speisen oder Flüssigkeiten auf Ihr Produkt gelangen, und stecken Sie keine Gegenstände in die Gehäuseschlitze oder -öffnungen Ihres Produkts.
- Verwenden Sie dieses Produkt nicht in unmittelbarer Nähe von Wasser und nicht in Bereichen mit hoher Luftfeuchtigkeit oder Kondensation, es sei denn, es ist speziell zur Nutzung in Außenbereichen vorgesehen und eingestuft.
- Halten Sie das Produkt von Heizkörpern und anderen Quellen fern, die Wärme erzeugen.
- Trennen Sie das Produkt immer von der Stromzufuhr, bevor Sie es reinigen und verwenden Sie dazu ausschließlich ein trockenes fusselfreies Tuch.

CONSIGNES DE SÉCURITÉ

Les consignes générales de sécurité ci-après sont fournies afin d'assurer votre sécurité personnelle et de protéger le produit d'éventuels dommages. Veuillez consulter les consignes d'utilisation du produit pour plus de détails.

- L'électricité statique peut endommager les composants électroniques. Déchargez l'électricité statique de votre corps (en touchant un objet en métal relié à la terre par exemple) avant de toucher le produit.
- N'essayez pas d'intervenir sur le produit et ne le démontez jamais. Pour certains produits contenant une batterie remplaçable par l'utilisateur, veuillez lire et suivre les consignes contenues dans le manuel d'utilisation.
- Ne renversez pas d'aliments ou de liquide sur le produit et n'insérez jamais d'objets dans les orifices.
- N'utilisez pas ce produit à proximité d'un point d'eau, de zones très humides ou de condensation sauf si le produit a été spécifiquement conçu pour une application extérieure.
- Éloignez le produit des radiateurs et autres sources de chaleur.
- Débranchez toujours le produit de l'alimentation avant de le nettoyer et utilisez uniquement un chiffon sec non pelucheux.

INSTRUCCIONES DE SEGURIDAD

Las siguientes directrices de seguridad general se facilitan para ayudarle a garantizar su propia seguridad personal y para proteger el producto frente a posibles daños. No olvide consultar las instrucciones del usuario del producto para obtener más información.

- La electricidad estática puede resultar nociva para los componentes electrónicos. Descargue la electricidad estática de su cuerpo (p. ej., tocando algún metal sin revestimiento conectado a tierra) antes de tocar el producto.
- No intente realizar el mantenimiento del producto ni lo desmonte nunca. Para algunos productos con batería reemplazable por el usuario, lea y siga las instrucciones del manual de usuario.
- No derrame comida o líquidos sobre el producto y nunca deje que caigan objetos en las aberturas del mismo.
- No utilice este producto cerca del agua, en zonas con humedad o condensación elevadas a menos que el producto esté clasificado específicamente para aplicación en exteriores.
- Mantenga el producto alejado de los radiadores y de otras fuentes de calor.
- Desenchufe siempre el producto de la alimentación de red antes de limpiarlo y utilice solo un paño seco sin pelusa.

ISTRUZIONI PER LA SICUREZZA

Le seguenti linee guida sulla sicurezza sono fornite per contribuire a garantire la sicurezza personale degli utenti e a proteggere il prodotto da potenziali danni. Per maggiori dettagli, consultare le istruzioni per l'utente del prodotto.

- L'elettricità statica può essere pericolosa per i componenti elettronici. Scaricare l'elettricità statica dal corpo (ad esempio toccando una parte metallica collegata a terra) prima di toccare il prodotto.
- Non cercare di riparare il prodotto e non smontarlo mai. Per alcuni prodotti dotati di batteria sostituibile dall'utente, leggere e seguire le istruzioni riportate nel manuale dell'utente.
- Non versare cibi o liquidi sul prodotto e non spingere mai alcun oggetto nelle aperture del prodotto.
- Non usare questo prodotto vicino all'acqua, in aree con elevato grado di umidità o soggette a condensa a meno che il prodotto non sia specificatamente approvato per uso in ambienti esterni.
- Tenere il prodotto lontano da caloriferi e altre fonti di calore.
- Scollegare sempre il prodotto dalla presa elettrica prima di pulirlo e usare solo un panno asciutto che non lasci filacce.

VEILIGHEIDSINFORMATIE

De volgende algemene veiligheidsinformatie werd verstrekt om uw eigen persoonlijke veiligheid te waarborgen en uw product te beschermen tegen mogelijke schade. Denk eraan om de gebruikersinstructies van het product te raadplegen voor meer informatie.

- Statische elektriciteit kan schadelijk zijn voor elektronische componenten. Ontlaad de statische elektriciteit van uw lichaam (d.w.z. het aanraken van geaard bloot metaal) voordat u het product aanraakt.
- U mag nooit proberen het product te onderhouden en u mag het product nooit demonteren. Voor sommige producten met door de gebruiker te vervangen batterij, dient u de instructies in de gebruikershandleiding te lezen en te volgen.
- Mors geen voedsel of vloeistof op uw product en u mag nooit voorwerpen in de openingen van uw product duwen.
- Gebruik dit product niet in de buurt van water, gebieden met hoge vochtigheid of condensatie, tenzij het product specifiek geclassificeerd is voor gebruik buitenshuis.
- Houd het product uit de buurt van radiators en andere warmtebronnen.
- U dient het product steeds los te koppelen van de stroom voordat u het reinigt en gebruik uitsluitend een droge pluisvrije doek.

Disposing and Recycling Your Product

ENGLISH

EN



This symbol on the product or packaging means that according to local laws and regulations this product should be not be disposed of in household waste but sent for recycling. Please take it to a collection point designated by your local authorities once it has reached the end of its life, some will accept products for free. By recycling the product and its packaging in this manner you help to conserve the environment and protect human health.

D-Link and the Environment

At D-Link, we understand and are committed to reducing any impact our operations and products may have on the environment. To minimise this impact D-Link designs and builds its products to be as environmentally friendly as possible, by using recyclable, low toxic materials in both products and packaging.

D-Link recommends that you always switch off or unplug your D-Link products when they are not in use. By doing so you will help to save energy and reduce CO2 emissions.

To learn more about our environmentally responsible products and packaging please visit www.dlinkgreen.com.

DEUTSCH

DE



Dieses Symbol auf dem Produkt oder der Verpackung weist darauf hin, dass dieses Produkt gemäß bestehender örtlicher Gesetze und Vorschriften nicht über den normalen Hausmüll entsorgt werden sollte, sondern einer Wiederverwertung zuzuführen ist. Bringen Sie es bitte zu einer von Ihrer Kommunalbehörde entsprechend amtlich ausgewiesenen Sammelstelle, sobald das Produkt das Ende seiner Nutzungsdauer erreicht hat. Für die Annahme solcher Produkte erheben einige dieser Stellen keine Gebühren. Durch ein auf diese Weise durchgeführtes Recycling des Produkts und seiner Verpackung helfen Sie, die Umwelt zu schonen und die menschliche Gesundheit zu schützen.

D-Link und die Umwelt

D-Link ist sich den möglichen Auswirkungen seiner Geschäftstätigkeiten und seiner Produkte auf die Umwelt bewusst und fühlt sich verpflichtet, diese entsprechend zu mindern. Zu diesem Zweck entwickelt und stellt D-Link seine Produkte mit dem Ziel größtmöglicher Umweltfreundlichkeit her und verwendet wiederverwertbare, schadstoffarme Materialien bei Produktherstellung und Verpackung.

D-Link empfiehlt, Ihre Produkte von D-Link, wenn nicht in Gebrauch, immer auszuschalten oder vom Netz zu nehmen. Auf diese Weise helfen Sie, Energie zu sparen und CO2-Emissionen zu reduzieren.

Wenn Sie mehr über unsere umweltgerechten Produkte und Verpackungen wissen möchten, finden Sie entsprechende Informationen im Internet unter www.dlinkgreen.com.

FRANÇAIS

FR



Ce symbole apposé sur le produit ou son emballage signifie que, conformément aux lois et réglementations locales, ce produit ne doit pas être éliminé avec les déchets domestiques mais recyclé. Veuillez le rapporter à un point de collecte prévu à cet effet par les autorités locales; certains accepteront vos produits gratuitement. En recyclant le produit et son emballage de cette manière, vous aidez à préserver l'environnement et à protéger la santé de l'homme.

D-Link et l'environnement

Chez D-Link, nous sommes conscients de l'impact de nos opérations et produits sur l'environnement et nous engageons à le réduire. Pour limiter cet impact, D-Link conçoit et fabrique ses produits de manière aussi écologique que possible, en utilisant des matériaux recyclables et faiblement toxiques, tant dans ses produits que ses emballages.

D-Link recommande de toujours éteindre ou débrancher vos produits D-Link lorsque vous ne les utilisez pas. Vous réaliserez ainsi des économies d'énergie et réduirez vos émissions de CO2.

Pour en savoir plus sur les produits et emballages respectueux de l'environnement, veuillez consulter le www.dlinkgreen.com.

ESPAÑOL

ES



Este símbolo en el producto o el embalaje significa que, de acuerdo con la legislación y la normativa local, este producto no se debe desechar en la basura doméstica sino que se debe reciclar. Llévelo a un punto de recogida designado por las autoridades locales una vez que ha llegado al fin de su vida útil; algunos de ellos aceptan recogerlos de forma gratuita. Al reciclar el producto y su embalaje de esta forma, contribuye a preservar el medio ambiente y a proteger la salud de los seres humanos.

D-Link y el medio ambiente

En D-Link, comprendemos y estamos comprometidos con la reducción del impacto que puedan tener nuestras actividades y nuestros productos en el medio ambiente. Para reducir este impacto, D-Link diseña y fabrica sus productos para que sean lo más ecológicos posible, utilizando materiales reciclables y de baja toxicidad tanto en los productos como en el embalaje.

D-Link recomienda apagar o desenchufar los productos D-Link cuando no se estén utilizando. Al hacerlo, contribuirá a ahorrar energía y a reducir las emisiones de CO2.

Para obtener más información acerca de nuestros productos y embalajes ecológicos, visite el sitio www.dlinkgreen.com.

ITALIANO

IT



La presenza di questo simbolo sul prodotto o sulla confezione del prodotto indica che, in conformità alle leggi e alle normative locali, questo prodotto non deve essere smaltito nei rifiuti domestici, ma avviato al riciclo. Una volta terminato il ciclo di vita utile, portare il prodotto presso un punto di raccolta indicato dalle autorità locali. Alcuni questi punti di raccolta accettano gratuitamente i prodotti da riciclare. Scegliendo di riciclare il prodotto e il relativo imballaggio, si contribuirà a preservare l'ambiente e a salvaguardare la salute umana.

D-Link e l'ambiente

D-Link cerca da sempre di ridurre l'impatto ambientale dei propri stabilimenti e dei propri prodotti. Allo scopo di ridurre al minimo tale impatto, D-Link progetta e realizza i propri prodotti in modo che rispettino il più possibile l'ambiente, utilizzando materiali riciclabili a basso tasso di tossicità sia per i prodotti che per gli imballaggi.

D-Link raccomanda di spegnere sempre i prodotti D-Link o di scollegarne la spina quando non vengono utilizzati. In questo modo si contribuirà a risparmiare energia e a ridurre le emissioni di anidride carbonica.

Per ulteriori informazioni sui prodotti e sugli imballaggi D-Link a ridotto impatto ambientale, visitate il sito all'indirizzo www.dlinkgreen.com.

NEDERLANDS

NL



Dit symbool op het product of de verpakking betekent dat dit product volgens de plaatselijke wetgeving niet mag worden weggegooid met het huishoudelijk afval, maar voor recyclage moeten worden ingeleverd. Zodra het product het einde van de levensduur heeft bereikt, dient u het naar een inzamelpunt te brengen dat hiertoe werd aangeduid door uw plaatselijke autoriteiten, sommige autoriteiten accepteren producten zonder dat u hiervoor dient te betalen. Door het product en de verpakking op deze manier te recyclen helpt u het milieu en de gezondheid van de mens te beschermen.

D-Link en het milieu

Bij D-Link spannen we ons in om de impact van onze handelingen en producten op het milieu te beperken. Om deze impact te beperken, ontwerpt en bouwt D-Link zijn producten zo milieuvriendelijk mogelijk, door het gebruik van recycleerbare producten met lage toxiciteit in product en verpakking.

D-Link raadt aan om steeds uw D-Link producten uit te schakelen of uit de stekker te halen wanneer u ze niet gebruikt. Door dit te doen bespaart u energie en beperkt u de CO₂-emissies.

Breng een bezoek aan www.dlinkgreen.com voor meer informatie over onze milieuverantwoorde producten en verpakkingen.

POLSKI

PL



Ten symbol umieszczony na produkcie lub opakowaniu oznacza, że zgodnie z miejscowym prawem i lokalnymi przepisami niniejszego produktu nie wolno wyrzucać jak odpady czy śmieci z gospodarstwa domowego, lecz należy go poddać procesowi recyklingu. Po zakończeniu użytkowania produktu, niektóre odpowiednie do tego celu podmioty przyjmą takie produkty nieodpłatnie, dlatego prosimy dostarczyć go do punktu zbiórki wskazanego przez lokalne władze. Poprzez proces recyklingu i dzięki takiemu postępowaniu z produktem oraz jego opakowaniem, pomogą Państwo chronić środowisko naturalne i dbać o ludzkie zdrowie.

D-Link i środowisko

D-Link podchodzimy w sposób świadomy do ochrony otoczenia oraz jesteśmy zaangażowani w zmniejszanie wpływu naszych działań i produktów na środowisko naturalne. W celu zminimalizowania takiego wpływu firma D-Link konstruuje i wytwarza swoje produkty w taki sposób, aby były one jak najbardziej przyjazne środowisku, stosując do tych celów materiały nadające się do powtórnego wykorzystania, charakteryzujące się małą toksycznością zarówno w przypadku samych produktów jak i opakowań.

Firma D-Link zaleca, aby Państwo zawsze prawidłowo wyłączali z użytku swoje produkty D-Link, gdy nie są one wykorzystywane. Postępując w ten sposób pozwalają Państwo oszczędzać energię i zmniejszać emisje CO₂.

Aby dowiedzieć się więcej na temat produktów i opakowań mających wpływ na środowisko prosimy zapoznać się ze stroną Internetową www.dlinkgreen.com.

ČESKY

CZ



Tento symbol na výrobku nebo jeho obalu znamená, že podle místně platných předpisů se výrobek nesmí vyhazovat do komunálního odpadu, ale odeslat k recyklaci. Až výrobek doslouží, odnese jej prosím na sběrné místo určené místními úřady k tomuto účelu. Někteřá sběrná místa přijímají výrobky zdarma. Recyklací výrobku i obalu pomáháte chránit životní prostředí i lidské zdraví.

D-Link a životní prostředí

Ve společnosti D-Link jsme si vědomi vlivu našich provozů a výrobků na životní prostředí a snažíme se o minimalizaci těchto vlivů. Proto své výrobky navrhujeme a vyrábíme tak, aby byly co nejekologičtější, a ve výrobcích i obalech používáme recyklovatelné a nízkotoxické materiály.

Společnost D-Link doporučuje, abyste své výrobky značky D-Link vypnuli nebo vytáhli ze zásuvky vždy, když je nepoužíváte. Pomůžete tak šetřit energii a snížit emise CO₂.

Více informací o našich ekologických výrobcích a obalech najdete na adrese www.dlinkgreen.com.

MAGYAR

HU



Ez a szimbólum a terméken vagy a csomagoláson azt jelenti, hogy a helyi törvényeknek és szabályoknak megfelelően ez a termék nem semmisíthető meg a háztartási hulladékkal együtt, hanem újrahasznosításra kell küldeni. Kérjük, hogy a termék élettartamának elteltét követően vigye azt a helyi hatóság által kijelölt gyűjtőhelyre. A termékek egyes helyeken ingyen elhelyezhetők. A termék és a csomagolás újrahasznosításával segíti védeni a környezetet és az emberek egészségét.

A D-Link és a környezet

A D-Linknél megértjük és elköteleztünk vagyunk a műveleteink és termékeink környezetre gyakorolt hatásainak csökkentésére. Az ezen hatás csökkentése érdekében a D-Link a lehető leginkább környezetbarát termékeket tervez és gyárt azáltal, hogy újrahasznosítható, alacsony károsanyag-tartalmú termékeket gyárt és csomagolásokat alkalmaz.

A D-Link azt javasolja, hogy mindig kapcsolja ki vagy húzza ki a D-Link termékeket a tápforrásból, ha nem használja azokat. Ezzel segít az energia megtakarításában és a széndioxid kibocsátásának csökkentésében.

Környezetbarát termékeinkről és csomagolásainkról további információkat a www.dlinkgreen.com weboldalon tudhat meg.

NORSK

NO



Dette symbolet på produktet eller forpakningen betyr at dette produktet ifølge lokale lover og forskrifter ikke skal kastes sammen med husholdningsavfall, men leveres inn til gjenvinning. Vennligst ta det til et innsamlingssted anvist av lokale myndigheter når det er kommet til slutten av levetiden. Noen steder aksepteres produkter uten avgift. Ved på denne måten å gjenvinne produktet og forpakningen hjelper du å verne miljøet og beskytte folks helse.

D-Link og miljøet

Hos D-Link forstår vi oss på og er forpliktet til å minske innvirkningen som vår drift og våre produkter kan ha på miljøet. For å minimalisere denne innvirkningen designer og lager D-Link produkter som er så miljøvennlig som mulig, ved å bruke resirkulerbare, lav-toksiske materialer både i produktene og forpakningen.

D-Link anbefaler at du alltid slår av eller frakobler D-Link-produkter når de ikke er i bruk. Ved å gjøre dette hjelper du å spare energi og å redusere CO2-utslipp.

For mer informasjon angående våre miljøansvarlige produkter og forpakninger kan du gå til www.dlinkgreen.com.

DANSK

DK



Dette symbol på produktet eller emballagen betyder, at dette produkt i henhold til lokale love og regler ikke må bortskaffes som husholdningsaffald, mens skal sendes til genbrug. Indlever produktet til et indsamlingssted som angivet af de lokale myndigheder, når det er nået til slutningen af dets levetid. I nogle tilfælde vil produktet blive modtaget gratis. Ved at indlevere produktet og dets emballage til genbrug på denne måde bidrager du til at beskytte miljøet og den menneskelige sundhed.

D-Link og miljøet

Hos D-Link forstår vi og bestræber os på at reducere enhver indvirkning, som vores aktiviteter og produkter kan have på miljøet. For at minimere denne indvirkning designer og producerer D-Link sine produkter, så de er så miljøvenlige som muligt, ved at bruge genanvendelige materialer med lavt giftighedsniveau i både produkter og emballage.

D-Link anbefaler, at du altid slukker eller frakobler dine D-Link-produkter, når de ikke er i brug. Ved at gøre det bidrager du til at spare energi og reducere CO₂-udledningerne.

Du kan finde flere oplysninger om vores miljømæssigt ansvarlige produkter og emballage på www.dlinkgreen.com.

SUOMI

FI



Tämä symboli tuotteen pakkauksessa tarkoittaa, että paikallisten lakien ja säännösten mukaisesti tätä tuotetta ei pidä hävittää yleisen kotitalousjätteen seassa vaan se tulee toimittaa kierrätettäväksi. Kun tuote on elinkaarensa päässä, toimita se lähimpään viranomaisten hyväksymään kierrätyspisteeseen. Kierrättämällä käytetyn tuotteen ja sen pakkauksen autat tukemaan sekä ympäristön että ihmisten terveyttä ja hyvinvointia.

D-Link ja ympäristö

D-Link ymmärtää ympäristönsuojelun tärkeyden ja on sitoutunut vähentämään tuotteistaan ja niiden valmistuksesta ympäristölle mahdollisesti aiheutuvia haittavaikutuksia. Nämä negatiiviset vaikutukset minimoidakseen D-Link suunnittelee ja valmistaa tuotteensa mahdollisimman ympäristöystävällisiksi käyttämällä kierrätettäviä, alhaisia pitoisuuksia haitallisia aineita sisältäviä materiaaleja sekä tuotteissaan että niiden pakkauksissa.

Suosittellemme, että irrotat D-Link-tuotteesi virtalähteestä tai sammutat ne aina, kun ne eivät ole käytössä. Toimimalla näin autat säästämään energiaa ja vähentämään hiilidioksiidipäästöjä.

Lue lisää ympäristöystävällisistä D-Link-tuotteista ja pakkauksistamme osoitteesta www.dlinkgreen.com.

SVENSKA

SE



Den här symbolen på produkten eller förpackningen betyder att produkten enligt lokala lagar och föreskrifter inte skall kastas i hushållssoporna utan i stället återvinnas. Ta den vid slutet av dess livslängd till en av din lokala myndighet utsedd uppsamlingsplats, vissa accepterar produkter utan kostnad. Genom att på detta sätt återvinna produkten och förpackningen hjälper du till att bevara miljön och skydda människors hälsa.

D-Link och miljön

På D-Link förstår vi och är fast beslutna att minska den påverkan våra verksamheter och produkter kan ha på miljön. För att minska denna påverkan utformar och bygger D-Link sina produkter för att de ska vara så miljövänliga som möjligt, genom att använda återvinningsbara material med låg gifthalt i både produkter och förpackningar.

D-Link rekommenderar att du alltid stänger av eller kopplar ur dina D-Link produkter när du inte använder dem. Genom att göra detta hjälper du till att spara energi och minska utsläpp av koldioxid.

För mer information om våra miljöansvariga produkter och förpackningar www.dlinkgreen.com.

PORTUGUÊS

PT



Este símbolo no produto ou embalagem significa que, de acordo com as leis e regulamentações locais, este produto não deverá ser eliminado juntamente com o lixo doméstico mas enviado para a reciclagem. Transporte-o para um ponto de recolha designado pelas suas autoridades locais quando este tiver atingido o fim da sua vida útil, alguns destes pontos aceitam produtos gratuitamente. Ao reciclar o produto e respectiva embalagem desta forma, ajuda a preservar o ambiente e protege a saúde humana.

A D-Link e o ambiente

Na D-Link compreendemos e comprometemo-nos com a redução do impacto que as nossas operações e produtos possam ter no ambiente. Para minimizar este impacto a D-Link concebe e constrói os seus produtos para que estes sejam o mais inofensivos para o ambiente possível, utilizando materiais recicláveis e não tóxicos tanto nos produtos como nas embalagens.

A D-Link recomenda que desligue os seus produtos D-Link quando estes não se encontrarem em utilização. Com esta acção ajudará a poupar energia e reduzir as emissões de CO₂.

Para saber mais sobre os nossos produtos e embalagens responsáveis a nível ambiental visite www.dlinkgreen.com.