



# User Manual

## Vigilance Full HD H.265 Outdoor Bullet Camera

DCS-4701E

---

# Preface

D-Link reserves the right to revise this publication and to make changes in the content hereof without obligation to notify any person or organization of such revisions or changes. Information in this document may become obsolete as our services and websites develop and change.

## Manual Revisions

Revision	Date	Description
2.00	14/05/2018	Version B1 with firmware version 2.00
2.10	25/10/2018	Minor updates

## Trademarks

D-Link and the D-Link logo are trademarks or registered trademarks of D-Link Corporation or its subsidiaries in the United States or other countries. All other company or product names mentioned herein are trademarks or registered trademarks of their respective companies.

Copyright © 2018 D-Link Corporation.

All rights reserved. This publication may not be reproduced, in whole or in part, without prior expressed written permission from D-Link Corporation.

---

# Table of Contents

<b>Product Overview.....</b>	<b>4</b>	Camera Info.....	58
Package Contents.....	4	Time .....	59
Introduction.....	5	Administration Settings .....	62
System Requirements .....	5	Camera Log .....	65
Features.....	6	<b>Technical Specifications.....</b>	<b>66</b>
Hardware Overview .....	7		
<b>Installation.....</b>	<b>9</b>		
Mounting the Camera.....	9		
Waterproofing Your Installation .....	11		
Software Installation .....	14		
<b>Configuration .....</b>	<b>17</b>		
Using the Configuration Interface.....	17		
Live Video .....	19		
Setup Wizard .....	21		
<b>Network Setup Wizard.....</b>	<b>22</b>		
Motion Detection Setup Wizard.....	24		
Settings .....	26		
Network Settings .....	26		
Camera Settings .....	32		
Event Management.....	39		
Advanced Setup.....	48		
Advanced.....	48		
Camera Configuration.....	54		
Camera Options .....	58		

# Product Overview

## Package Contents



DCS-4701E Vigilance Full HD H.265 Outdoor Bullet Camera



Cable Waterproofing Connector



Rubber Power Connector Plug



Mounting Kit



CD-ROM with User Manual and software



Quick Installation Guide

If any of the above items are missing, please contact your reseller.

**Safety Notice:** Installation and servicing should be done by certified technicians to conform with all local codes and prevent voiding your warranty.

## Introduction

The DCS-4701E Vigilance Full HD H.265 Outdoor Bullet Camera is a professional surveillance and security solution for small, medium, and large enterprises. It uses a full-HD progressive scan CMOS sensor to deliver low-noise video and low-light capability ideal for surveillance applications. The DCS-4701E offers a complete surveillance solution featuring a built-in IR cut filter and IR LEDs effective up to 30 meters with built-in smart IR function, avoiding overexposure of near objects at night, allowing it to stream simultaneous real-time full-HD resolution video 24/7. In addition, the IP66-certified weatherproof housing make the DCS-4701E ideal for both indoor and outdoor applications.

The DCS-4701E streams video with H.265 compression which has lower a bandwidth requirement compared to H.264 while also saving storage capacity of NVR/VMS. The DCS-4701E also incorporates Power over Ethernet (PoE), allowing it to be easily installed in a variety of locations especially with D-Link Surveillance Switches which supports ONVIF and surveillance VLAN, bandwidth control, and cable diagnostics functions.

The DCS-4701E can be accessed remotely, controlled, and configured from any computer over your local network or through the Internet via a web browser. The simple installation and intuitive web-based interface offer easy configuration across the full range of its advanced feature set and make it an ideal choice for a dependable and cost-effective surveillance solution with easy clutter-free installation.

## System Requirements

- Computer with Microsoft Windows® 10, 8, or 7, Mac OSX 10.9 or above
- Internet Explorer 9 or higher for Windows®, Firefox 2-51, 52 ESR, Chrome 42 or higher, or Safari 9 or higher for MacOS X
- Existing 10/100 Ethernet-based network with an available 802.3af Power over Ethernet (PoE) port

## Features

### **H.265 Compression**

The DCS-4701E supports the latest H.265 compression algorithm to bring out the best combination of performance, quality, bandwidth, and storage space.

### **Simple to Maintain**

The DCS-4701E is a stand-alone system with a built-in CPU, requiring no special hardware or software. The DCS-4701E can be viewed and managed through most web browsers, including Internet Explorer®, Chrome®, Firefox®, and Safari®.

### **Supports a Variety of Platforms**

With support for TCP/IP networking, HTTP/HTTPS, and other Internet-related protocols, the DCS-4701E can also be integrated easily into other Internet/Intranet applications because of its standards-based features. The DCS-4701E works in any network that supports 10/100 Ethernet, making the DCS-4701E easy to integrate into your existing network environment.

### **Advanced Event Management**

The DCS-4701E can be set up to send e-mail notifications with snapshots when an event occurs, such as when motion is detected. Events can be triggered from several sources, such as motion detection and time-based events.

### **IR LEDs for Day and Night Functionality**

The built-in infrared LEDs enable night time viewing of up to 30 meters. With built-in smart IR function, it can avoid overexposure of near objects at night.

### **IP66 Weatherproof and Vandal-proof Housing**

The DCS-4701E uses an IP66 weatherproof housing, allowing you to rest assured that in the toughest of conditions, it will continue to provide round-the-clock surveillance.

### **PoE (Power over Ethernet) for Flexible Installation**

The DCS-4701E can draw all the power it needs from a PoE switch or PoE injector for a simple and clutter-free installation.

### **Remote Monitoring Utility**

The D-Link D-ViewCam™ application adds enhanced features and functionality for the camera and allows administrators to configure and access the camera from a separate site via Intranet or Internet. Other features include image monitoring, recording images to a hard drive, viewing up to 32 cameras on one screen, and taking snapshots.

## Hardware Overview

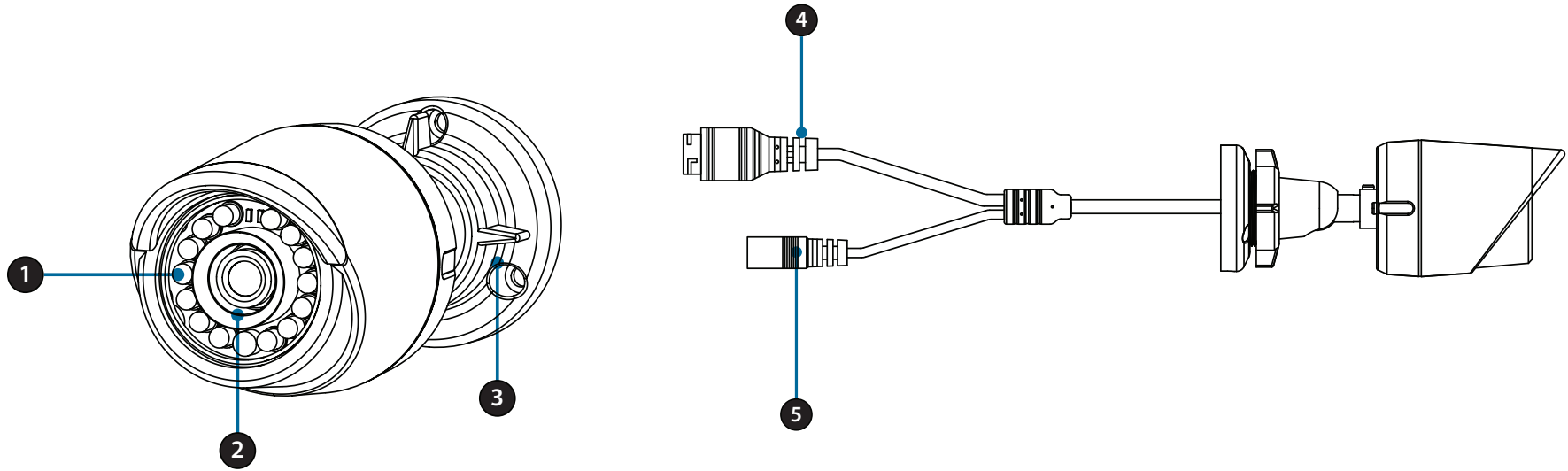

1	<b>IR LEDs</b>	Provide illumination for low-light environments.
2	<b>Camera Lens</b>	Camera lens to record video of the surrounding area.
3	<b>Adjustment Ring</b>	Loosen to adjust and tighten to lock the camera angle.
4	<b>Ethernet Port</b>	RJ-45 connector for Ethernet which can also be used to power the camera using Power over Ethernet (PoE).
5	<b>Power Port</b>	Connects to an optional 12 V / 1.5 A power adapter (not included).

## Hardware Overview

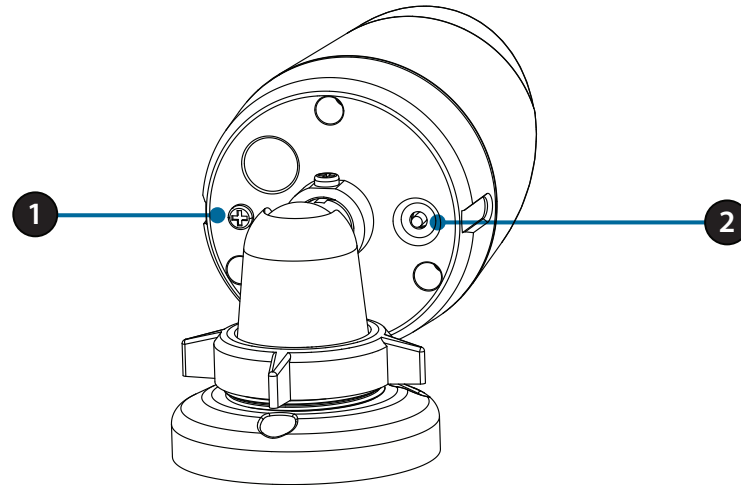

1	<b>Grounding Screw</b>	Used to connect the camera to ground.
2	<b>Reset Button</b>	Press and hold this button down for 10 seconds to reset the camera to factory default settings.



# Installation

## Mounting the Camera

It is highly recommended that you configure and test your camera before mounting it. Refer to "**Software Installation**" on page 14 for more information.

### Step 1

Place the mounting sticker where you want to position the camera.

Use a 6 mm drill bit to make the required holes approximately 25 mm deep, then insert the wall anchors into the holes.

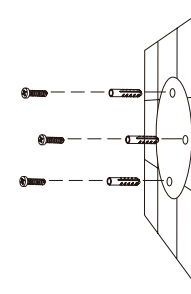

### Step 2

**If you are running the camera cables through the wall**, drill a hole in the center and pull the cables through the hole.

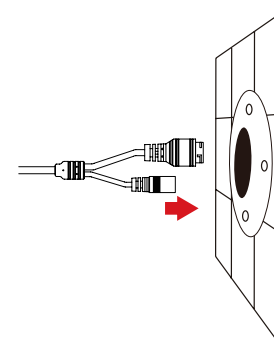

### Step 3

Use the screws provided to mount the camera to the wall.

**If you are running the camera cables out the side of the camera**, guide the camera cables through the cable channel on the base.

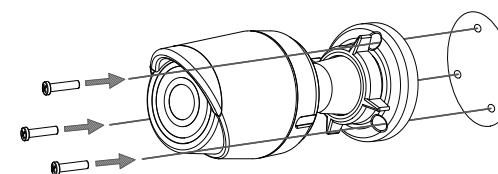

### Step 5

Connect the power and Ethernet cables, or just the Ethernet cable if you are using a PoE connection.

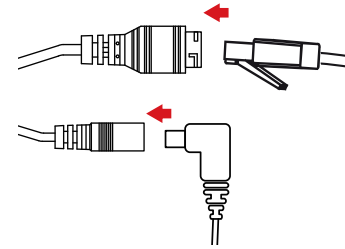

### Step 6

To adjust the camera's angle, turn the adjustment ring counterclockwise to loosen it, then move the camera to the desired position and angle. When you are finished, turn the adjustment ring clockwise to tighten it.

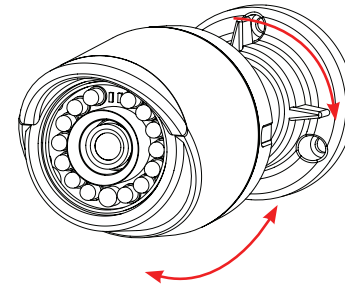

## Waterproofing Your Installation

Round Ethernet cable, a crimping tool, and RJ-45 plugs are required for this procedure.

### Step 1

Place the washer around the base of the Ethernet connector as shown.

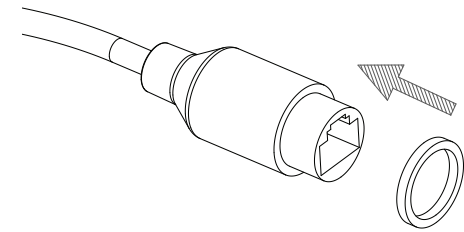

### Step 2

Thread bare Ethernet cable through the waterproof connector as shown, then crimp an RJ-45 plug onto the cable.

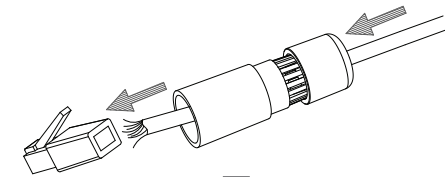

### Step 3

Crimp an RJ-45 connector onto the end of the cable.

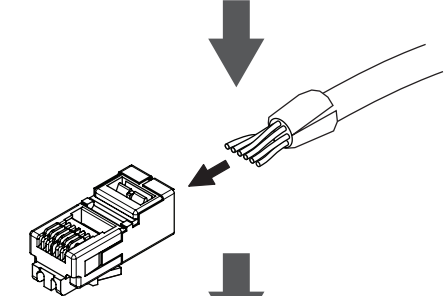

### Step 4

Connect the other end of the Ethernet cable to the camera's Ethernet port.

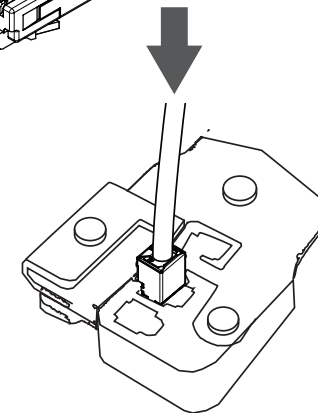

## Section 2: Installation

---

### Step 5

Connect the RJ-45 plug into the Ethernet connector, then screw the waterproof connector to the Ethernet connector by turning it about a half-turn clockwise.

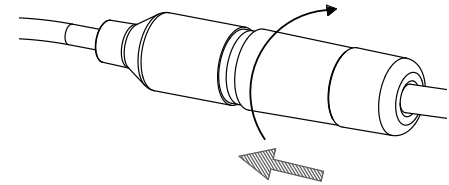
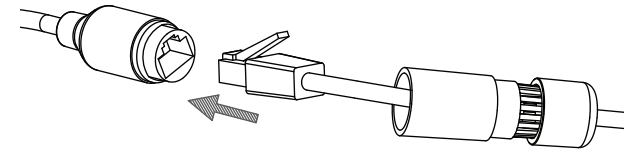

### Step 6

Screw the back part of the waterproof connector clockwise until there is a tight seal around the Ethernet cable.

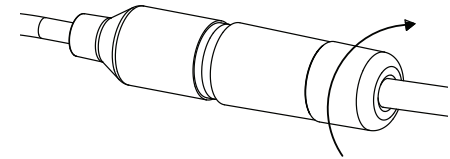

**If you are using PoE to power your camera,** use the power connector cap to seal the power connector.

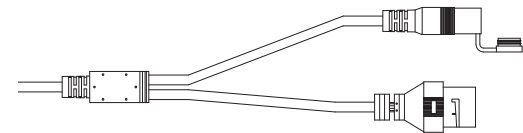

**If you are using a power adapter (not included) to power your camera,** wind waterproof tape around the connection in an overlapping manner to cover it.

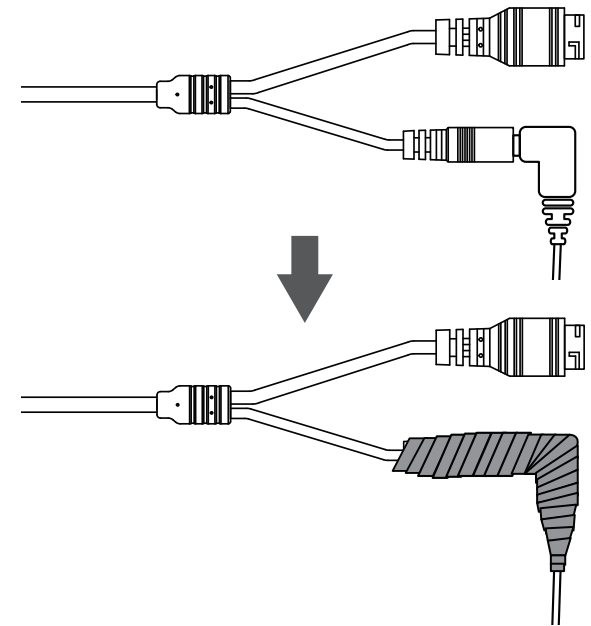

# Software Installation

## Step 1

Insert the DCS-4701E CD into your computer's CD-ROM drive to begin the installation.

If the Autorun function on your computer is disabled, or if the D-Link Launcher fails to start automatically, click the Start button and type **D:\autorun.exe** (where D: represents the drive letter of your CD-ROM drive) and press **Enter**.



## Step 2

Click on the **D-Link Setup Wizard SE** icon that was created in your Windows Start menu (**Start > D-Link > Setup Wizard SE**).

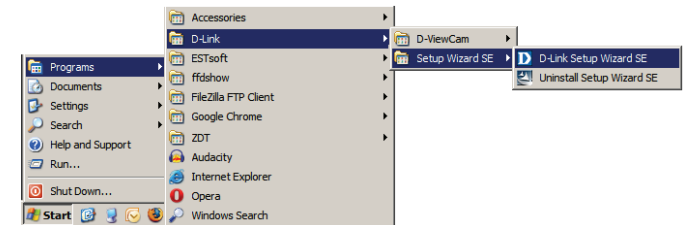

## Section 2: Installation

### Step 3

The Setup Wizard will appear and display the MAC address and IP address of your camera(s). If you have a DHCP server on your network, a valid IP Address will be displayed. If your network does not use a DHCP server, the network camera's default static IP **192.168.0.20** will be displayed.

Select your camera, then click the **Wizard** button to continue.

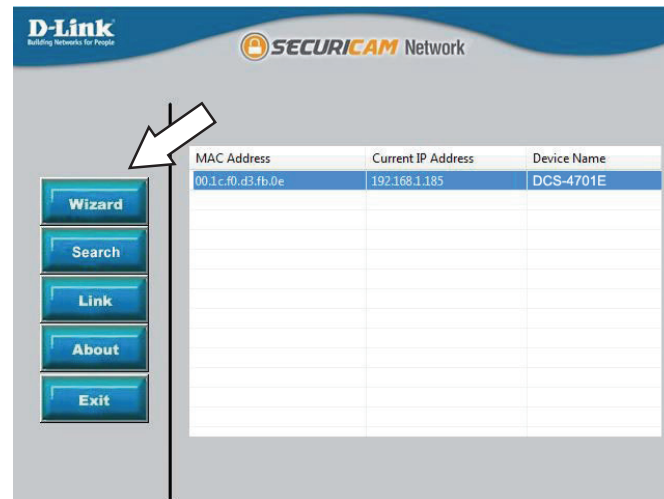

### Step 4

Enter the Admin ID and password. When logging in for the first time, the default Admin ID is **admin** with the password left blank.

Click the checkboxes if you wish to change the admin ID and password for the camera, and enter the new ID and password you wish to use.

Click **Next** to continue.

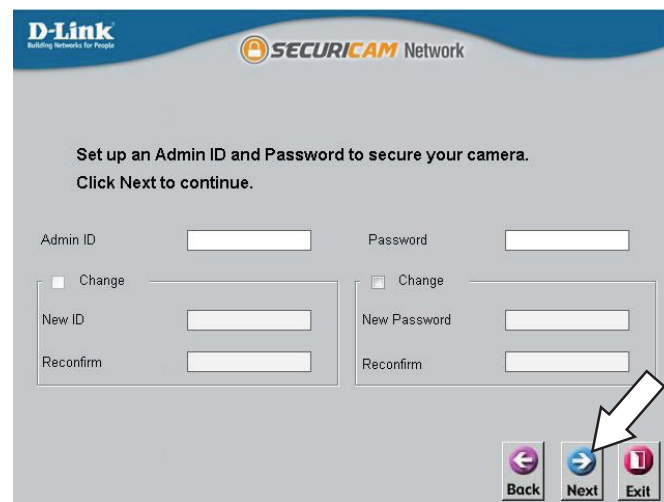

## Section 2: Installation

### Step 5

Select **DHCP** if your camera obtains an IP address automatically from a DHCP server such as a router. Select **Static IP** if you want to manually enter the IP settings for the camera.

Click **Next** to continue.



D-Link Building Networks for People

SECURICAM Network

### Set IP Address

DHCP

Static IP

IP Address

Subnet Mask

Default Gateway

Primary DNS

Secondary DNS

Back Next Exit

### Step 6

Take a moment to confirm your settings and click **Restart**.

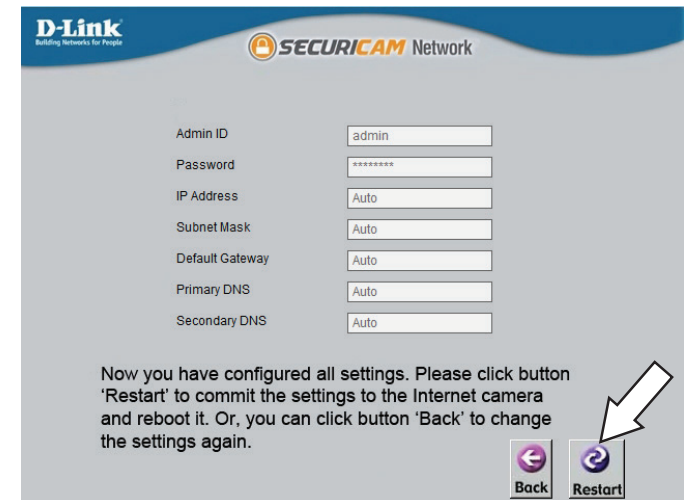

D-Link Building Networks for People

SECURICAM Network

Admin ID

Password

IP Address

Subnet Mask

Default Gateway

Primary DNS

Secondary DNS

Now you have configured all settings. Please click button 'Restart' to commit the settings to the Internet camera and reboot it. Or, you can click button 'Back' to change the settings again.

Back Restart



# Configuration

## Using the Configuration Interface

After completing the Camera Installation Wizard, you are ready to use your camera. The camera's built-in Web configuration utility is designed to allow you to easily access and configure your DCS-4701E. At the end of the wizard, click **Link**, or enter the IP address of your camera into a web browser, such as Firefox. To log in, use the User name **admin** and the password you created in the Installation Wizard. If you did not create a password, the default password is blank. After entering your password, click **OK**.

### Step 1

Click on the **D-Link Setup Wizard SE** icon that was created in your Windows Start menu (**Start > D-Link > Setup Wizard SE**).

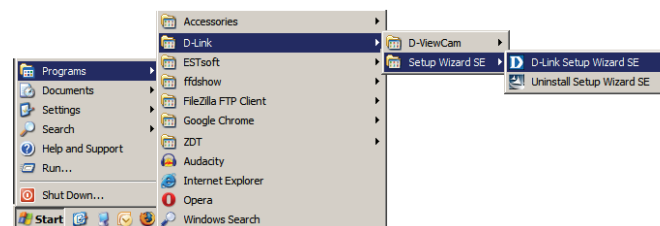

### Step 2

Select the camera and click **Link** to access the web configuration.

The Setup Wizard will automatically open your web browser to the IP address of the camera.

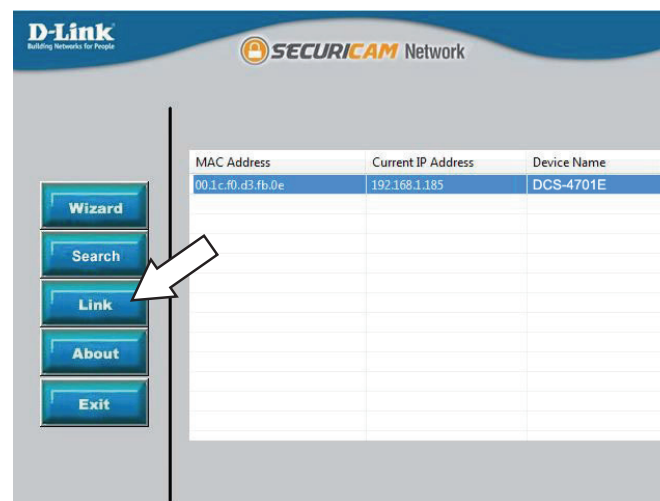

## Section 3: Configuration

### Step 3

The first time you connect to the camera, you will be asked to set a password for the administrator account. After entering a password, click **Save**.

OR

Under Password, enter the same password configured during setup and click **Login** to continue.



### Step 4

This section displays your camera's live video. You can select your video profile and view or operate the camera.









## Live Video



This section shows your camera's live video. You may select any of the available icons listed below to operate the camera. You may also select your language using the drop-down menu on the left side of the screen.

If your view window area is less than your frame size, you can click and drag on the live video to move the camera view around. Refer to **"Video Stream" on page 37**.



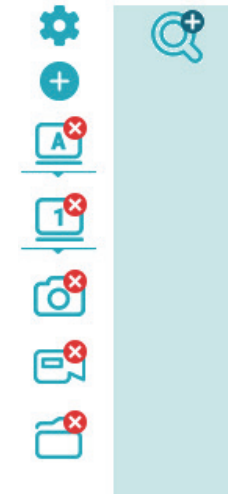

**Note:** If a system error message appears when clicking the snap or record buttons, you may need to (re)install the **Microsoft Visual C++ 2010 Redistributable Package (x86)** found on the included CD or download it from the Microsoft support site.

	<b>Setup</b>	Clicking this will take you to the camera configuration pages.
	<b>Edit Toolbar</b>	Clicking this will allow you to add and remove icons from the toolbar. This lets you create a custom toolbar with only the options you want.
	<b>Window Size</b>	You can choose between various screen sizes for your camera's video: <ul style="list-style-type: none"> <li>▪ <b>Auto Screen:</b> Automatically resize the camera video to match your browser window</li> <li>▪ <b>Full Screen:</b> View your camera video using the entire screen</li> <li>▪ <b>100% Screen:</b> View your camera's video at 100% size</li> <li>▪ <b>50% Screen:</b> View your camera's video at 50% size</li> <li>▪ <b>25% Screen:</b> View your camera's video at 25% size</li> </ul>
	<b>Video Profile 1/2</b>	Select a video profile to use. For more on setting up your video profiles, refer to <b>"Video Stream" on page 37</b> .
	<b>Take a Snapshot</b>	This will save a snapshot to your PC using the storage folder you have selected.
	<b>Record a Video Clip</b>	This will start recording a video clip to your PC using the storage folder you have selected. Click it again to stop recording. If you close the browser window, the recording will stop.



	<b>Set a Storage Folder</b>	Select a storage folder to save snapshots and video clips to.
	<b>Zoom In/Out</b>	Click this and use the slider to zoom in and out of your camera's video.

You can find these icons in the top-right corner of the Live Video screen:

	<b>Alarm</b>	This will flash red when motion is detected.
	<b>Record Status</b>	This will turn red when the camera is recording.
	<b>Help</b>	Click this to open a window that describes the Live Video controls.
	<b>Logout</b>	Click this to log out of the web interface.

# Setup Wizard

This page lets your use setup wizards to walk you through setting up your camera's network and motion detection settings.

**Network Setup Wizard:** Click on this button to start the Network Setup Wizard. Refer to **"Network Setup Wizard" on page 22.**

**Motion Detection Setup Wizard:** Click on this button to start the Motion Detection Setup Wizard. Refer to **"Motion Detection Setup Wizard" on page 24.**



## Network Setup Wizard

This wizard will guide you through a step-by-step process to configure your camera and connect it to the Internet. Click **Next** to continue.

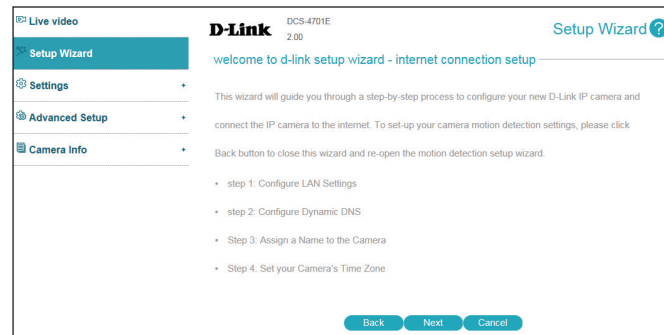

### Step 1:

Select how the camera will connect to the Internet.

- If your camera is connected to a router, or you are unsure how your camera will connect to the Internet, select **DHCP**.
- Select **Static IP Client** if your Internet Service Provider has provided you with connection settings, or if you wish to set a static address within your home network. Enter the correct configuration information and click **Next** to continue.
- If you are using PPPoE, select **PPPoE** and enter your user name and password.

Click **Next** to continue.

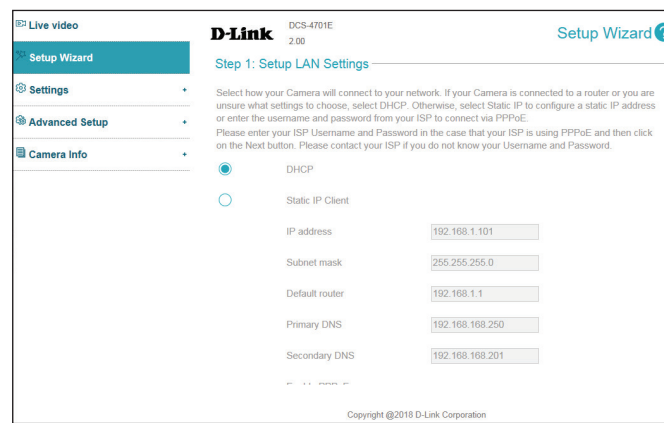

### Step 2:

If you have a Dynamic DNS account and would like the camera to update your IP address automatically, select **Enable DDNS** and enter your host information. Click **Next** to continue.

Live video D-Link DCS-4701E 2.00 Setup Wizard ?

step 2: Configure Dynamic DNS

If you have a Dynamic DNS account, you can configure your Camera to update your external IP address automatically by enabling DDNS and entering your account details. Click Next to continue.

Enable DDNS

Server Address  <<

Host Name

User Name

Password

Verify Password

Timeout:  (hours)

Back Next Cancel

### Step 3:

Enter a name for your camera and click **Next** to continue.

Live video D-Link DCS-4701E 2.00 Setup Wizard ?

Step 3: Assign a Name to the Camera

We recommend that you give your Camera a unique name to easily identify it on your network.

IP camera Name

Back Next Cancel

### Step 4:

Set the correct time to ensure that all events will be triggered as scheduled. Click **Next** to continue.

Live video D-Link DCS-4701E 2.00 Setup Wizard ?

Step 4: Set your Camera's Time Zone

Please set the correct time zone for your Camera to ensure that all events are triggered, captured, and scheduled correctly.

Time Zone:

Enable Daylight Saving

Back Next Cancel

### Step 5:

Confirm the settings are correct and click **Apply** to save them. The settings will be saved to the DCS-4701E and the camera will restart.

Live video D-Link DCS-4701E 2.00 Setup Wizard ?

Step 5: Setup Complete

The summary below shows the options you have selected. Click Finish to apply these options or click Back if you wish to make changes. Please make a note of these settings to ensure you can access your Camera in the future.

IP Address	DHCP
IP camera Name	DCS-4701E
Time Zone	(GMT) Coordinated Universal Time
DDNS	Disable
PPPoE	Disable

Back Apply Cancel

## Motion Detection Setup Wizard

This wizard will guide you through a step-by-step process to configure your camera's motion detection functions.

Click **Next** to continue.

### Step 1

This step will allow you to enable or disable motion detection, specify the detection sensitivity, and define what parts of the camera's view to monitor for motion.

You may specify whether the camera should capture a snapshot or record a video clip when motion is detected.

Please refer to "**Motion Detection**" on page 47 for more information about how to configure motion detection.

Click **Next** to continue.

### Step 2

This step allows you to enable motion detection based on a customized schedule. Specify the day and hours. You may also choose to always record whenever motion is detected.

Click **Next** to continue.

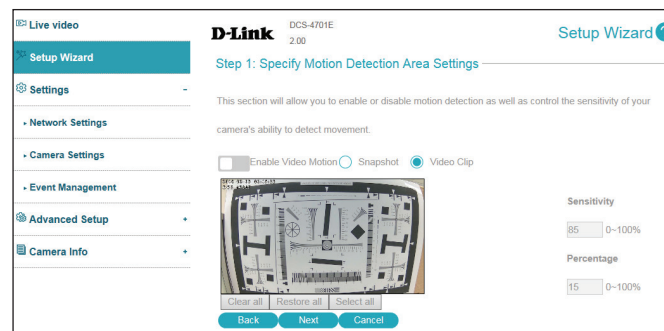



### Step 3

This step allows you to specify where to send the snapshot/video clip/system log when motion is detected. Select **E-mail**, **FTP**, or **Network Storage** and enter the relevant information.

Click **Next** to continue.

Live video D-Link DCS-4701E 2.00 Setup Wizard ?

Setup Wizard

Settings

Advanced Setup

Camera Info

Step 3: Alerts and Notification

This final step allows you to specify how you receive notification of camera events. Choose between an email notification or alternatively you can setup an FTP Notification. You will need your email account settings or FTP details. If you are unsure of this information, please contact your ISP. Once you have entered this information, please click on the Next button.

Do not notify me

Email

Sender email address

Recipient email address

Server address

D-Link DCS-4701E 2.00 Setup Wizard ?

User name

Password

Port

This server requires a secure connection (StartTLS)

FTP

Server address

Port

User name

Password

Remote folder name

Back Next Cancel

### Step 4

You have completed the Motion Detection Wizard.

Please verify your settings and click **Apply** to save them.

Please wait a few moments while the camera saves your settings and restarts.

Live video D-Link DCS-4701E 2.00 Setup Wizard ?

Setup Wizard

Settings

Advanced Setup

Camera Info

Step 4: Setup Complete

You have completed your IP camera setup. Please click the Back button if you want to review or modify your settings or click on the Apply button to save and apply your settings.

Motion Detection : Disable

EVENT : Video Clip

Schedule Day : Sun, Mon, Tue, Wed, Thu, Fri, Sat,

Schedule Time : Always

Alerts and Notification : Do not notify me

Back Apply Cancel

# Settings

## Network Settings

### LAN Settings

Use this section to configure the network connections for your camera. All relevant information must be entered accurately. Please note that PPPoE must be disabled to make any changes on this page; refer to **"PPPoE" on page 27** for more details. After making any changes, click the **Save** button to save your changes.

**DHCP:** Select this connection if you have a DHCP server running on your network and would like your camera to obtain an IP address automatically.

If you choose DHCP, you do not need to fill out the IP address settings.

**Static IP Client:** You may obtain a static or fixed IP address and other network information from your network administrator for your camera. A static IP address may simplify access to your camera in the future.

**IP address:** Enter the fixed IP address in this field.

**Subnet mask:** This number is used to determine if the destination is in the same subnet. The default value is 255.255.255.0.

**Default router:** Enter the router/gateway used to forward frames to destinations in a different subnet. Invalid router/gateway settings may cause the failure of transmissions to a different subnet.

**Primary DNS:** Enter the primary domain name server for translating domain names to IP addresses.

**Secondary DNS:** Enter the secondary domain name server for translating domain names to IP addresses.

## IPv6

Use this section to configure your camera's IPv6 settings. After making any changes, click the **Save** button to save your changes.

**Enable IPv6:** Enable the IPv6 setting to use the IPv6 protocol.

**Manually Setup The IP Address:** Enabling the option allows you to manually set up the address, specify an optional IP address, specify an optional router address, and an optional primary DNS address. You can click the **Information** button to see the IPv6 address lists for the host, gateway, and DNS server.

## PPPoE

Use this section to configure your camera's PPPoE settings. After making any changes, click the **Save** button to save your changes.

**Enable PPPoE:** Enable this setting if your network uses PPPoE.

**User Name / Password:** Enter the username and password for your PPPoE account. Re-enter your password in the Confirm Password field. You may obtain this information from your ISP.

**PPPoE Status:** This shows your current PPPoE connection status.

## HTTP and HTTPS

Use this section to configure the HTTP and HTTPS access settings for your camera. After making any changes, click the **Save** button to save your changes.

### HTTP

**HTTP Port:** The default port number is 80.

**Access Name for Stream 1~2:** The default name is **video#.mjpeg**, where # is the number of the stream.

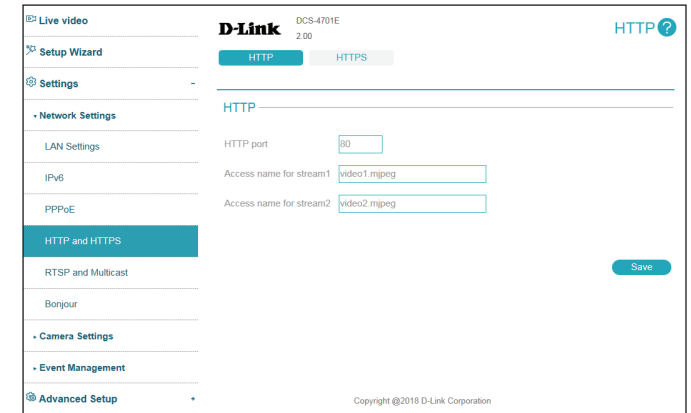

### HTTPS

**HTTPS Port:** You may use a PC with a secure browser to connect to the HTTPS port of the camera. The default port number is 443.

**Enable HTTPS Secure Connection:** Enable the HTTPS service.

**Create Certificate Method:** Choose the way the certificate should be created. Three options are available:

- Create a self-signed certificate automatically
- Create a self-signed certificate manually
- Create a certificate request and install

**Status:** Displays the status of the certificate.

**Note:** The certificate cannot be removed while the HTTPS is still enabled. To remove the certificate, you must first uncheck **HTTPS secure connection**.



## RTSP and Multicast

Use this section to configure your camera's RTSP and multicast stream settings. After making any changes, click the **Save** button to save your changes.

### RTSP

**Authentication:** Choose to enable or disable RTSP digest encryption. Digest encryption uses MD5 hashes.

**RTSP Port:** The port number that you use for RTSP streaming to mobile devices, such as mobile phones or tablets. The default port number is 554.

**Access Name for Stream 1/2:** You may specify the address of a particular stream. For instance, live1.sdp can be accessed at rtsp://x.x.x.x/live1.sdp where the x.x.x.x represents the ip address of your camera.

### Multicast

**Multicast for Stream 1/2:** The DCS-4701E allows you to multicast each of the available streams via a group address and specify the TTL value for each stream. Enter the port and TTL settings you wish to use if you do not want to use the defaults.

The screenshot shows the 'RTSP' configuration page in the D-Link DCS-4701E web interface. The 'RTSP' tab is selected. The 'Authentication' dropdown is set to 'Digest'. The 'RTSP port' is set to 554. The 'Access name for stream1' is 'live1.sdp' and the 'Access name for stream2' is 'live2.sdp'. A 'Save' button is visible in the bottom right corner.

The screenshot shows the 'Multicast' configuration page in the D-Link DCS-4701E web interface. The 'Multicast' tab is selected. There are two sections for stream configuration. For Stream 1, 'Enable multicast for stream 1' is checked, with a group address of 239.1.1.1, video port 6550, RTCP video port 6551, and TTL of 64. For Stream 2, 'Enable multicast for stream 2' is checked, with a group address of 239.1.1.2, video port 6554, and TTL of 64.

Multicast group address	239.1.1.1
Multicast video port	6550
Multicast RTCP video port	6551
Multicast TTL [1-255]	64
Enable multicast for stream 2	<input checked="" type="checkbox"/>
Multicast group address	239.1.1.2
Multicast video port	6554
Multicast RTCP video port	6555
Multicast TTL [1-255]	64

## Bonjour

Use this section to enable Bonjour, which allows your camera to be accessed more easily on your network. After making any changes, click the **Save** button to save your changes.

**Bonjour:** Enable this to enable Bonjour support.

**Bonjour Name:** Enter a name to identify this camera on Bonjour.

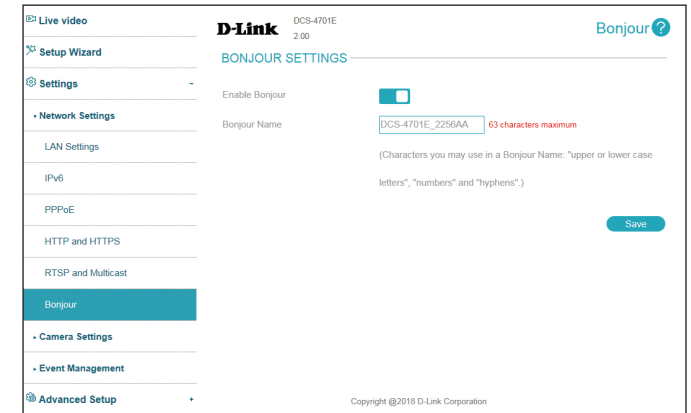

## Camera Settings Camera Settings

Use this section to configure the device name and LED behavior for your camera. After making any changes, click the **Save** button to save your changes.

**IP Camera Name:** Create a unique name for your camera that will be added to the file name prefix when creating a snapshot or a video clip.

**LED:** You may specify whether or not to illuminate the status LED on the camera. For security reasons, this setting is set to **Off** by default.

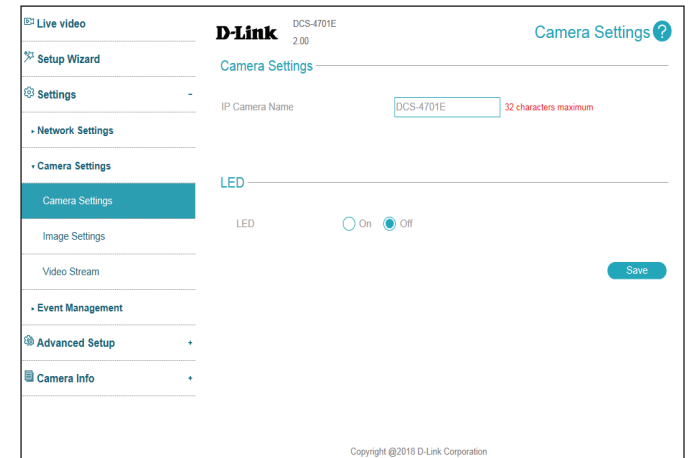



## Image Settings

In this section, you may configure the video image settings for your camera. All changes in the Image Settings section will be made immediately. For the other sections, after making any changes, click the **Save** button to save your changes.

### Image

**Mirror:** This will mirror the image horizontally.

**Flip:** This will flip the image vertically. When turning Flip on, you may want to consider turning **Mirror** on as well.

**Anti-Flicker:** Select the frequency used by your power lines to avoid interference or distortion.

**White Balance:** Use the drop-down box to change white balance settings to help balance colors for different environments. You can choose from **Auto**, **Outdoor**, **Indoor**.

**Exposure Mode:** Changes the exposure mode. Use the drop-down box to set the camera for **Indoor**, **Outdoor**, or **Night** environments, or to **Moving** to capture moving objects. You can also create 3 different custom exposure modes. Max Gain will limit the brightness of the exposure.

**Denoise:** This setting controls the amount of noise reduction that will be applied to the picture.



**Brightness:** Adjust this setting to compensate for backlit subjects.

**Contrast:** Adjust this setting to alter the color intensity/strength.

**Saturation:** This setting controls the amount of coloration, from grayscale to fully saturated.

**Sharpness:** Specify a value to determine how much sharpening to apply to the image.

**WDR Level:** Wide Dynamic Range (WDR) helps improve exposure, making it easier to see objects in very bright or dark areas of the camera's image. Specify a value to determine how much WDR adjustment to apply to the image, or select **None**.

**3D Filter:** This reduces the amount of image noise when viewing a low-light environment.

**Reset Default:** Click this button to reset the image to factory default settings.

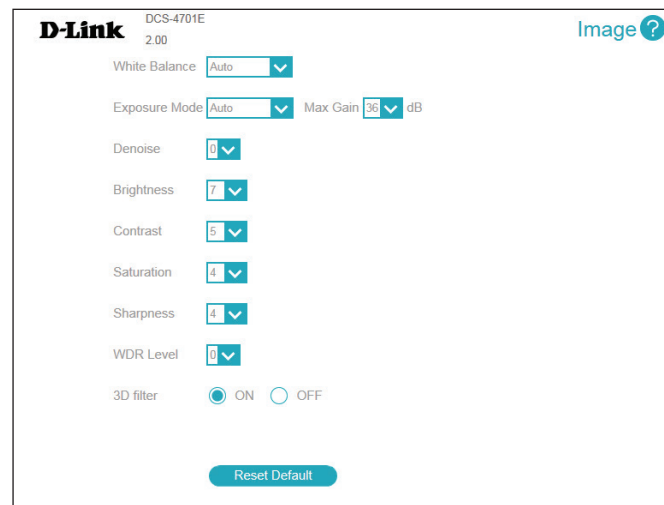

## ICR & IR

Use this section to configure the IR LED and IR-cut removable filter behavior for your camera.

### ICR

**Automatic:** The Day/Night mode is set automatically. Generally, the camera uses Day mode and switches to Night mode when needed. Use the **Sensitivity** drop-down box to select when the camera should switch to Night mode. The text to the right of the drop-down box shows what the current lighting conditions are like, and you can refresh this information by clicking the **Refresh** button.

**Day Mode:** Day mode enables the IR Cut Filter and turns off the IR LEDs.

**Night Mode:** Night mode disables the IR Cut Filter and turns on the IR LEDs.

**Schedule Mode:** Set Day/Night mode using the schedule set in the drop-down boxes. The camera will enter Day mode at the starting time and return to Night mode at the ending time.

Activate the **Disable IR LED** to set Day mode for the set times.

### IR Light

**IR Light Control:** The camera can enable or disable the IR (infrared) light according to your preferences. This setting provides additional controls depending on your specific application.

**Off:** Disables the IR light.

**On:** Enables the IR light.

**Sync With ICR:** The IR light will turn on when the ICR filter is disabled (night mode).

**Schedule:** The IR light will turn on or off according to the schedule that you specify below.

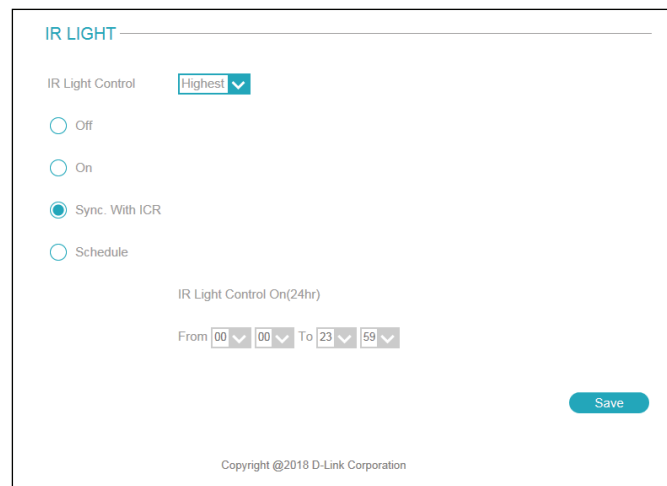
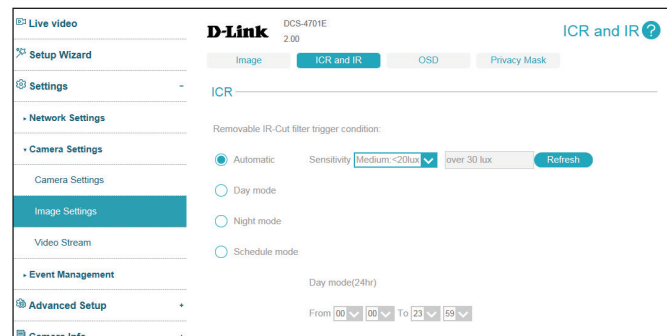

## OSD Settings

**OSD:** Select this option to enable the On-Screen Display feature for your camera. This will allow some information to appear in the top-left corner of the camera's video.

**Label:** Enter a label for the camera, which will be shown on the OSD when it is enabled.

## Privacy Mask

**Enable Privacy Mask Setting:** The Privacy Mask setting allows you to click and drag the mouse cursor over the camera image to draw maximum 3 rectangular areas which will be blocked/excluded from recordings and snapshots. Click the Save button to save your changes.

**Restore All:** Clear all privacy mask areas.

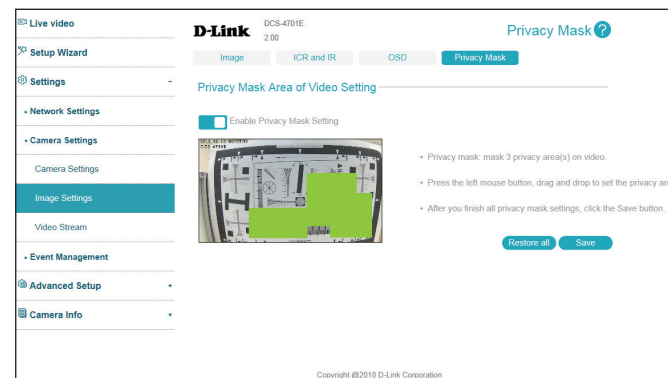
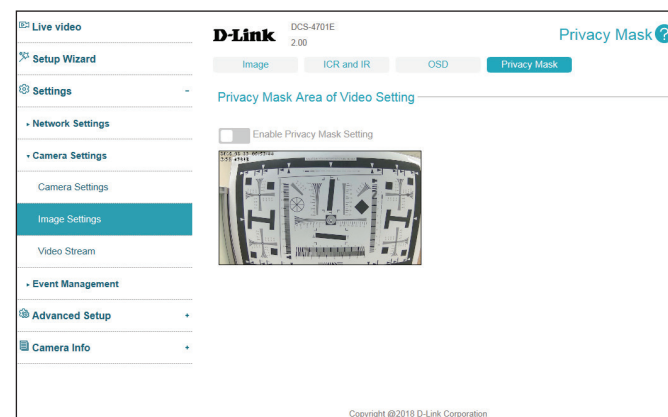
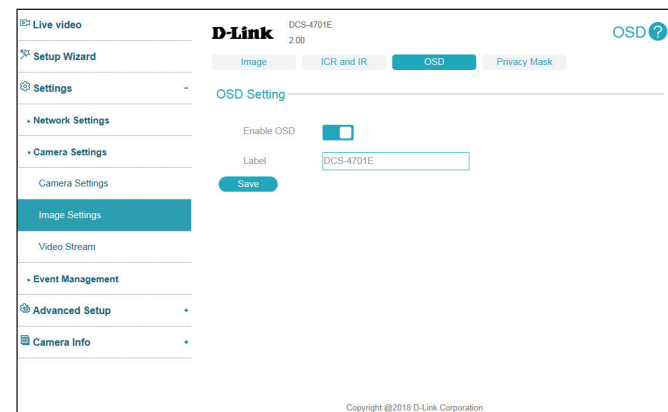

## Video Stream

You may configure up to 2 video profiles with different settings for your camera. This allows you to set different settings for recording video and for viewing your video remotely, for example. After making any changes, click the **Save** button to save your changes.

**Aspect Ratio:** Set whether you want your camera to use a 4:3 or 16:19 aspect ratio for its video. When changing this setting, you will need to redo setup for motion detection, privacy masks, and preset points.

**Mode:** Set the video codec to be used to **H.264**, **H.265**, or **JPEG**.

**Frame Size:** Select what frame size to use. Frame size determines the total capture resolution. Larger frame sizes provide more detail, but will require more bandwidth.

**Maximum Frame Rate:** You can set the maximum frame rate. A higher frame rate provides smoother motion for videos and requires more bandwidth. Lower frame rates will result in stuttering motion and require less bandwidth.

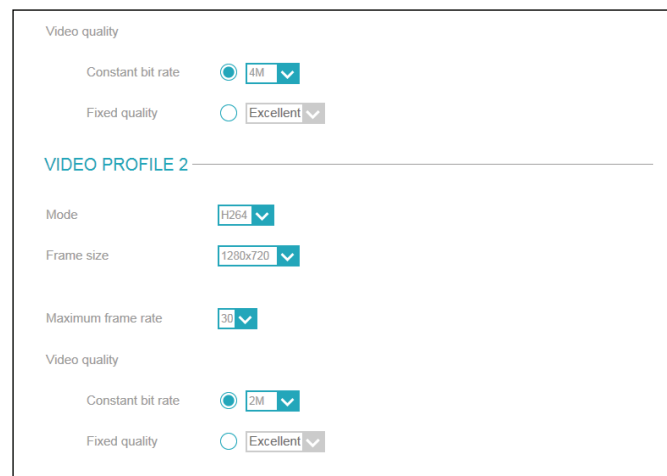
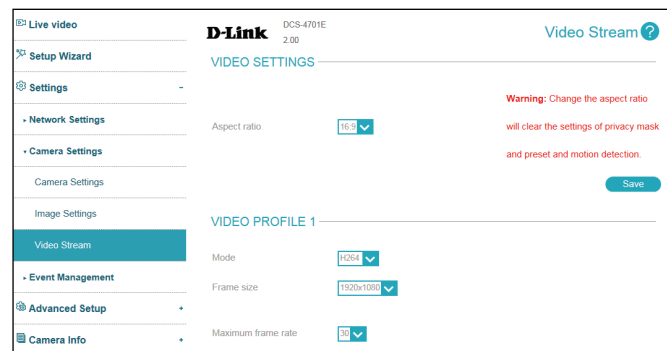

**Constant Bit Rate:** You can set the bit rate to use for this video profile.

**Fixed Quality:** Select the image quality level for the camera to try to maintain. Higher quality levels will result in increased bit rates and use more bandwidth.

The screenshot shows the configuration interface for the D-Link DCS-4701E camera. The interface is titled "D-Link DCS-4701E" and "Video Stream". It features two sections for video profile configuration. The top section is for "VIDEO PROFILE 1" and the bottom section is for "VIDEO PROFILE 2".

**VIDEO PROFILE 1:**

- Constant bit rate:  4M
- Fixed quality:  Excellent

**VIDEO PROFILE 2:**

- Mode: H264
- Frame size: 1280x720
- Maximum frame rate: 30
- Video quality:
  - Constant bit rate:  2M
  - Fixed quality:  Excellent

At the bottom right, there are "Save" and "Cancel" buttons. At the bottom center, there is a copyright notice: "Copyright ©2018 D-Link Corporation".

# Event Management

## Event Management

The DCS-4701E has a comprehensive event management system that lets you configure the camera to perform certain actions when an event occurs. For example, when motion is detected, you can have snapshots sent to an e-mail address. You can also configure the camera to take regular video recordings according to a schedule you define. Detailed information for the following steps can be found in the following pages.

### Step 1: Select your destination Server and Media type

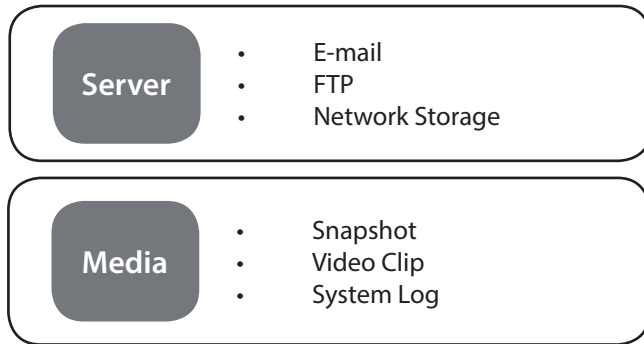

### Step 2: Select your Trigger event and Action

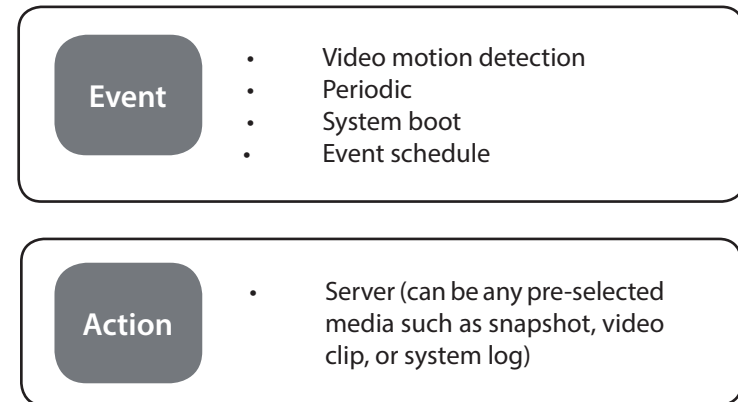

When an event is triggered:

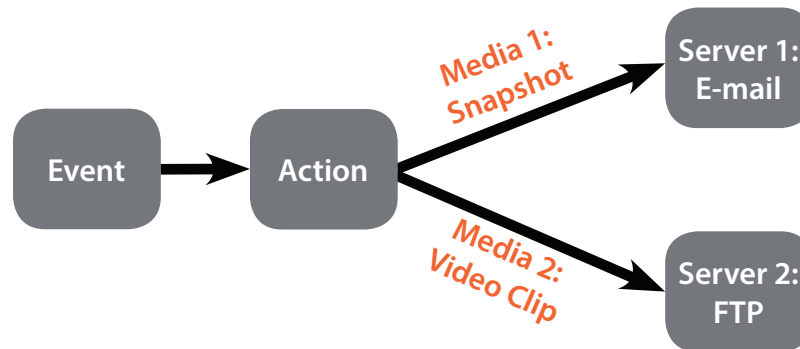

## Event Management

The Event Setup page includes 4 different sections:

- Server
- Media
- Event Settings
- Recording

1. To add a new server, media, event, or recording item, click **Add**. A screen will appear and allow you to update the fields accordingly.
2. To delete the selected item from the server, media, event, or recording drop-down menus, click the **Delete** button next to it.
3. Click on the name of an item to edit it.

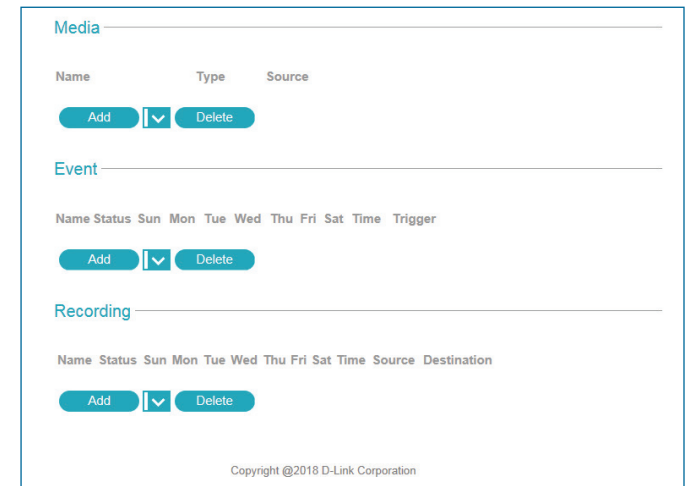
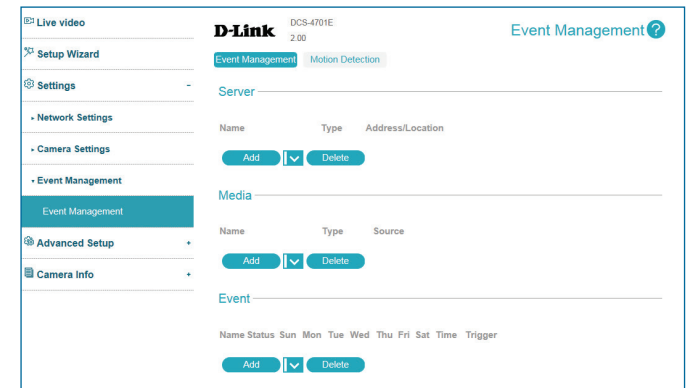



## Server

You can configure a server for each server type, and up to 5 FTP servers. After making any changes, click the **Save** button to save your changes.

**Server Name:** Enter the name for the server.

**Email:** If you want to use an e-mail address for your server, select this and enter the settings for your target e-mail account.

**FTP:** If you want to use an FTP server for your server, select this and enter the settings for your target FTP server.

**Network Storage:** If you want to use a network storage device for your server, select this and enter its settings here.

The screenshot displays the 'Event Management' configuration interface for a D-Link DCS-4701E device. The interface is divided into three main sections for server configuration:

- Email:** This section is currently selected. It includes a 'Server Name' field, a radio button for 'Email', and input fields for 'Sender email address', 'Recipient email address', 'Server address', 'User name', and 'Password'.
- FTP:** This section is unselected. It includes a radio button for 'FTP', input fields for 'Server address', 'Port' (set to 21), a 'Login Type' dropdown menu (set to 'Username & Password'), 'User name', 'Password', and 'Remote folder name' fields. There is also an unchecked checkbox for 'Passive mode'.
- Network storage:** This section is unselected. It includes a radio button for 'Network storage', a 'Network storage location' field, a note '(for example: \\my\_nas\disk\folder)', and input fields for 'Workgroup', 'User name', 'Password', and 'Primary WINS server'.

At the bottom right of the configuration area, there are three buttons: 'Test', 'Save', and 'Cancel'.

## Media

There are three types of media: **Snapshot**, **Video Clip**, and **System Log**. You can make a media entry for each type. After making any changes, click the **Save** button to save your changes.

**Media Name:** Enter a unique name for media type you want to create.

**Snapshot:** Select this option to set the media type to snapshots.

**Source:** Set the video profile to use as the media source. Refer to "**Video Stream**" on **page 37** for more information on video profiles.

**Send pre-event image(s):** Set the number of pre-event images to take. Pre-event images are images taken before the main event snapshot is taken.

**Send post-event image(s):** Set the number of post-event images to take. Post-event images are images taken after the main event snapshot is taken.

For example:

If both the Send pre-event images and Send post-event images are set to 4, a total of 9 images are generated after a trigger is activated.

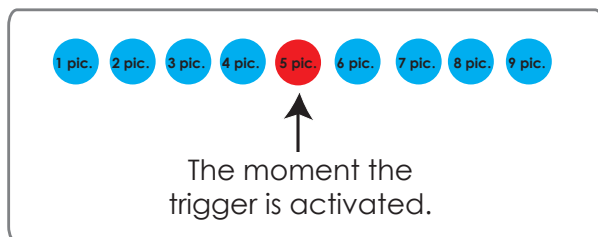

The screenshot shows the D-Link Event Management configuration page. The 'Media Type' is set to 'Snapshot'. The 'Source' is set to 'profile 1'. The 'Send' fields for pre-event and post-event images are both set to 1. The 'File Name Prefix' field is empty. The 'Add date and time suffix to file name' checkbox is unchecked. The 'Video Clip' and 'System log' options are also visible but not selected. A 'Save' button is located at the bottom right of the configuration area.

**File name prefix:** The prefix name will be added to the file name.

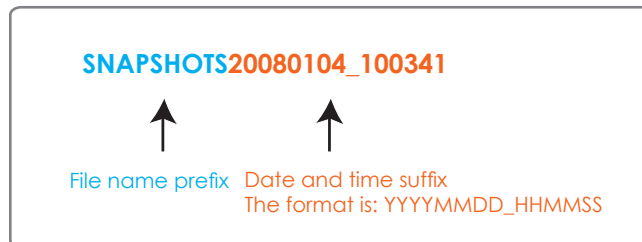

**Add date and time suffix to file name:** Enable this to add the date and time the snapshot was recorded as a file name suffix.

**Video clip:** Select this option to set the media type to video clips.

**Source:** Set the video profile to use as the media source. Refer to **"Video Stream" on page 37** for more information on video profiles.

**Pre-event recording:** This sets how many seconds to record before the main event video clip starts.

**Maximum duration:** Set the maximum length of video to record for your video clips.

**Maximum file size:** Set the maximum file size to record for your video clips.

**File Name Prefix:** This is the prefix that will be added to the filename of saved video clips.

**System log:** Select this option to set the media type to system logs. This will save the event to the camera system log, but will not record any snapshots or video.

The screenshot shows the 'Event Management' configuration page for a D-Link DCS-4701E camera. The page is divided into several sections:

- Media Type:** Includes a 'Media name' field and a radio button for 'Snapshot' (which is selected).
- Source:** A dropdown menu showing 'profile 1'.
- Advanced Setup:** Includes 'Send' fields for pre-event image(s) [0-4] and post-event image(s) [0-7], and a 'File Name Prefix' field.
- Video Clip:** Includes a radio button (not selected), a 'Source' dropdown (set to 'profile 1'), and input fields for 'Pre-event recording' (Second(s) [0-3]), 'Maximum duration' (Second(s) [1-100]), and 'Maximum file size' (Kbytes [300-5000]).
- System log:** Includes a radio button (not selected).

A 'Save' button is located at the bottom right of the configuration area. The footer of the page reads 'Copyright ©2018 D-Link Corporation'.

## Event

Create and schedule up to three events with their own settings here. After making any changes, click the **Save** button to save your changes.

**Event name:** Enter a name for the event.

**Enable this event:** Toggle this to activate this event.

**Priority:** Set the priority for this event. Events with higher priority will be executed first.

**Delay for:** Specify the delay time before allowing this event to be triggered again. This is used for both motion detection events and event triggers.

## Trigger

**Video Motion Detection:** Selecting this will trigger the event when motion is detected during live video monitoring. Make sure you have enabled motion detection and specified what part of the image to monitor for motion. For more details, refer to **"Motion Detection" on page 47**.

**Periodic:** Selecting this will trigger the event in specified intervals. The trigger interval unit is in minutes.

**System Boot:** Selecting this will trigger an event when the system boots up.

The screenshot shows the 'Event Management' configuration page for a D-Link DCS-4701E camera. The page is divided into several sections:

- Event:** Includes an 'Event name' input field, an 'Enable this event' toggle, a 'Priority' dropdown menu (set to 'normal'), and a 'Delay for' input field (set to 10 seconds).
- Trigger:** Offers two options: 'Video motion detection' (selected) and 'Periodic'.
- Trigger every:** A dropdown menu set to '1 minutes'.
- System boot:** A radio button option.
- Event Schedule:** A calendar view with checkboxes for days of the week (Sun, Mon, Tue, Wed, Thu, Fri, Sat).
- Time:** Includes an 'Always' radio button and a 'From' 'To' time range selector (set to 00:00 to 23:59).
- Action:** A radio button option labeled 'test2' with an 'Attached media' dropdown menu (set to 'T2').

A 'Save' button is located at the bottom right of the configuration area.

### Event Schedule

Specify when you want to monitor for this event. Select which days to monitor for this event, then select **Always** or enter the time interval to monitor for the specified event.

**Action:** Select the actions you want the camera to take when the event happens. Select the Server to use, then choose the Media you want to save to it. Please note that you need to set up your Server and Media entries first.

The screenshot shows the 'Event Settings' page for a D-Link camera. The interface is divided into several sections:

- Event Management:** Includes tabs for 'Event MGMT', 'SD Card', 'Motion', and 'Tamper'. The 'Event MGMT' tab is active.
- Event:** Contains an 'Event Name' input field, an 'Enable This Event' checkbox, a 'Priority' dropdown menu (set to 'Normal'), and a 'Delay for' input field (set to '10' seconds).
- Trigger:** Features radio buttons for 'Video Motion Detection' (selected), 'Periodic', 'Camera Boot', 'Network Lost', and 'Tamper Detection'. The 'Periodic' option has a sub-field 'Trigger Every' set to '1' minutes.
- Event Schedule:** Includes a calendar view with days of the week (Sun, Mon, Tue, Wed, Thu, Fri, Sat) and a 'Time' section with radio buttons for 'Always' (selected) and 'From' (with time selection dropdowns).
- Action:** Contains a 'Server' dropdown menu (set to 'Server 1') and an 'Attached media' dropdown menu (set to 'None').

A 'Save' button is located at the bottom right of the form.

## Recording

Here you can configure and schedule the recording settings. After making any changes, click the **Save** button to save your changes.

**Recording Entry Name:** Enter a name for the recording.

**Enable This Recording:** Select this to enable the recording function.

**Priority:** Set the priority for this entry. An entry with a higher priority value will be executed first.

**Source:** Select the video profile to use as the recording source.

### Recording Schedule

Use the checkboxes to set which days to record video on. Select **Always** to record for the entire day, or select **From** and select what period of time you want to record using the drop-down boxes.

**Destination:** Select a storage destination that was configured in Server to send recordings there.

**Size of Each File for Recording:** If this is selected, files will be split based on the file size you specify.

**Time of Each File for Recording:** If this is selected, files will be based on the maximum length you specify.

**File Name Prefix:** The prefix name will be added to the beginning of the file name of the recording file(s).

The screenshot shows the 'Recording' configuration page in the D-Link web interface. The page is titled 'Recording' and is part of the 'Event Management' section. It includes the following fields and options:

- Recording entry name:** A text input field.
- Enable this recording:** A checkbox.
- Priority:** A dropdown menu set to 'normal'.
- Source:** A dropdown menu set to 'profile 1'.
- Recording Schedule:** A section with radio buttons for 'Always' (selected) and 'From' (with time dropdowns for '00:00' to '23:59'). Below this are checkboxes for days of the week: Sun, Mon, Tue, Wed, Thu, Fri, Sat.
- Recording Settings:** A section with a dropdown for 'Destination' (set to 'None'), a text input for 'Total cycling recording size' (set to '1000' Mbytes), a radio button for 'Size of each file for recording' (set to '10' Mbytes), a radio button for 'Time of each file for recording' (set to '10' seconds), and a text input for 'File Name Prefix'.
- Save:** A blue button at the bottom right.

## Motion Detection

Motion detection enables the camera to monitor the video feed for movement. Here, you can adjust the sensitivity settings that determine whether motion is detected by the camera or not. After making any changes, click the **Save** button to save your changes.

**Enable Video Motion:** Enable this to enable the motion detection feature of your camera. Please note that you must create at least one motion detection box for the camera to detect motion.

**Sensitivity:** Set how sensitive motion detection will be from 0% to 100%. A low sensitivity means that there must be large changes between two images in order to detect motion, and a high sensitivity means that even small changes will cause motion to be detected.

Low sensitivities may be useful when monitoring an area that has flickering lights or a window to the outside in view. High sensitivities may be useful when monitoring an area that rarely changes, such as a storeroom or warehouse.

**Percentage:** Set how much of the area being monitored for motion must change for motion to be detected. A low percentage means that only part of the area being monitored has to change to detect motion, and a high percentage means that most of the area needs to change to detect motion.

Low percentages can be useful when monitoring an area such as a large room, and high percentages can be useful when you are only monitoring a specific part of the camera's view, such as a doorway.

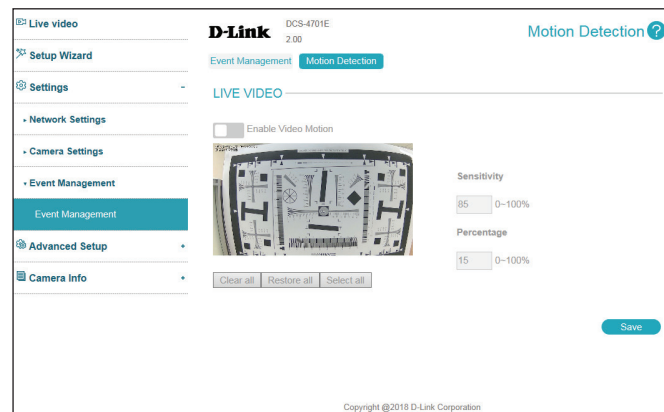

# Advanced Setup

## Advanced UPnP

Enabling Video Motion will allow your camera to use UPnP to automatically set up port forwarding on your router. After making any changes, click the **Save** button to save your changes.

**Enable UPnP Presentation:** Enabling this setting allows your camera to be configured as a UPnP device on your network.

**Enable UPnP Port Forwarding:** Enabling this setting allows the camera to add port forwarding entries into the router automatically on a UPnP capable network.

**Forwarding Port:** If UPnP Port Forwarding is enabled, you can set which port to use for forwarding.

**Forwarding Status:** If UPnP Port Forwarding is enabled, this will show the UPnP Port Forwarding status.

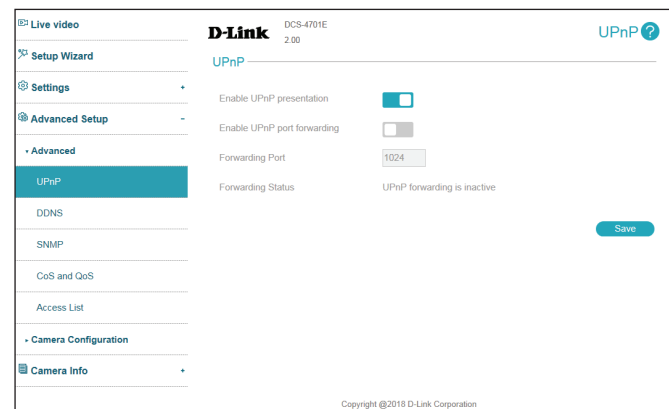



## DDNS

DDNS allows you to compensate for changing IP addresses by having a URL that automatically points to the current IP address of your camera. To do this, you will need to have an account with one of the DDNS services listed in the drop-down box on this page. After making any changes, click the **Save** button to save your changes.

**DDNS:** Check this box to enable the DDNS function.

**Server Address:** Enter your DDNS server address, or select a service from the drop-down menu.

**Host Name:** Enter the host name of the DDNS service.

**User Name:** Enter the username or e-mail address used to connect to the DDNS service.

**Password:** Enter the password used to connect to the DDNS service.

**Verify Password:** Enter your DDNS service password again.

**Timeout:** You can set up how often the camera notifies the DDNS service of its current global IP address by entering a whole number in hours.

**Status:** This shows the current status of your DDNS updates.

The screenshot displays the 'DYNAMIC DNS SETTING' interface. On the left, a sidebar contains navigation links: 'Live video', 'Setup Wizard', 'Settings', 'Advanced Setup', 'Advanced', 'UPnP', 'DDNS', 'SNMP', 'CoS and QoS', 'Access List', 'Camera Configuration', and 'Camera Info'. The main panel is titled 'DYNAMIC DNS SETTING' and features the following elements:

- Enable DDNS:** A toggle switch that is currently turned on.
- Server Address:** A dropdown menu showing 'www.dlinkddns.com' with a double arrow icon and a small dropdown arrow.
- Host Name:** An empty text input field.
- User Name:** An empty text input field.
- Password:** An empty text input field.
- Verify Password:** An empty text input field.
- Timeout:** A text input field containing the number '24', followed by '(hours)'.
- Status:** A label indicating the current status is 'Active'.
- Save:** A blue button located at the bottom right of the form.

At the bottom of the page, there is a small copyright notice: 'Copyright ©2018 D-Link Corporation'.

## SNMP

Here you can set the Simple Network Management Protocol (SNMP) settings for the camera, which allow for SNMP management of the camera. After making any changes, click the **Save** button to save your changes.

**Enable SNMPv1, SNMPv2c:** Enable this option to allow for SNMPv1 and SNMPv2c management of the camera.

**Read/Write Community:** Enter a name for the read/write community of your SNMP server.

**Read Only Community:** Enter a name for the read-only community of your SNMP server.

**Enable SNMPv3:** Enable this option to allow SNMPv3 management of the camera.

**Read/Write Security Name:** Enter a name for the read/write community of your read/write SNMP server.

**Authentication Type:** Enter the type of authentication used by your read/write SNMP server.

**Authentication Password:** Enter the authentication password used for your read/write SNMP server.

**Encryption Password:** Enter the encryption password used for your read/write SNMP server.

**Read Only Security Name:** Enter a name for the read-only community of your read-only SNMP server.

The screenshot displays the D-Link DCS-4701E web interface for SNMP configuration. The interface is split into two main sections: 'SNMP Configuration' and 'SNMPv3 Configuration'. In the 'SNMP Configuration' section, there are checkboxes for 'Enable SNMPv1, SNMPv2c' and 'Enable SNMPv3'. Below these are text input fields for 'Read/Write community', 'Read only community', 'Read/Write Security name', and 'Read only security name'. There are also dropdown menus for 'Authentication type' (set to MD5) and input fields for 'Authentication password' and 'Encryption password'. The 'SNMPv3 Configuration' section has a similar layout with its own set of fields and checkboxes. A 'Save' button is positioned at the bottom right of the configuration area. The page footer includes the copyright notice: 'Copyright ©2018 D-Link Corporation'.

**Authentication Type:** Enter the type of authentication used by your read-only SNMP server.

**Authentication Password:** Enter the authentication password used for your read-only SNMP server.

**Encryption Password:** Enter the encryption password used for your read-only SNMP server.

The screenshot shows the configuration page for the D-Link DCS-4701E device, specifically the SNMP settings. The page is titled "D-Link DCS-4701E 2.00" and has an "SNMP ?" link in the top right corner. The configuration is organized into two sections. The first section, "Enable SNMPv3", has a toggle switch that is currently turned off. Below this, there are three fields: "Read/Write Security name" with the value "public", "Authentication type" with a dropdown menu set to "MD5", and "Authentication password" with an empty text box. The second section, "Read only security name", has a field with the value "private", "Authentication type" with a dropdown menu set to "MD5", "Authentication password" with an empty text box, and "Encryption password" with an empty text box. A "Save" button is located at the bottom right of the configuration area. At the bottom of the page, there is a copyright notice: "Copyright ©2018 D-Link Corporation".

## CoS and QoS

Class of Service (CoS) and Quality of Service (QoS) allow you to prioritize surveillance traffic on your network to ensure that your cameras can stream video smoothly and remain accessible even when there is heavy traffic on your network. Your network must support CoS or QoS in order to use them. After making any changes, click the **Save** button to save your changes.

**Enable CoS:** Enabling the Class of Service setting implements a best-effort policy to prioritize traffic without making any bandwidth reservations.

To use CoS, enable it, enter the VLAN ID to use for the camera, and set the priority for your **Live Video**, **Live Audio**, **Event/Alarm**, and **Management** camera traffic.

**Enable QoS:** Enabling QoS allows you to specify a traffic priority policy to ensure a consistent Quality of Service during busy periods. If the network camera is connected to a router that itself implements QoS, the router's settings will override the QoS settings of the camera.

To use QoS, enable it and set the priority for your **Live Video**, **Live Audio**, **Event/Alarm**, and **Management** camera traffic.

The screenshot displays the configuration page for a D-Link DCS-4701E camera. The interface is divided into several sections:

- Navigation Menu:** Includes Live video, Setup Wizard, Settings, Advanced Setup, UPnP, DDNS, SNMP, CoS and QoS (highlighted), Access List, and Camera Configuration.
- CoS SETTINGS:**
  - CoS:  (disabled)
  - VLAN ID:  (with a red warning icon and text [0-4095])
  - Live video:  (dropdown)
  - Live audio:  (dropdown)
  - Event/Alarm:  (dropdown)
  - Management:  (dropdown)
- QoS SETTINGS:**
  - QoS:  (disabled)
  - Live video:  (dropdown)
  - Live audio:  (dropdown)
  - Event/Alarm:  (dropdown)
  - Management:  (dropdown)
- Bottom Section:**
  - Live audio:  (dropdown)
  - Event/Alarm:  (dropdown)
  - Management:  (dropdown)
  - QoS SETTINGS:**
    - QoS:  (disabled)
    - Live video:  (dropdown)
    - Live audio:  (dropdown)
    - Event/Alarm:  (dropdown)
    - Management:  (dropdown)
- Buttons:** A blue **Save** button is located at the bottom right.
- Footer:** Copyright ©2018 D-Link Corporation.

## Access List

Here you can define which IP addresses are allowed to view your DCS-4701E. You can set up to 7 IP address ranges for both the allow and deny lists.

**Allow List:** The section lets you define what IP addresses have access rights to the camera.

**Note:** When adding entries to the Allow list, make sure the first entry includes the IP address of the computer or device you are using to access the camera. Otherwise, you may be blocked from accessing the camera after adding the entry to the Allow list.

**Start IP Address:** The starting IP address of the IP address range for the devices (such as a computer) that have permission to access the video of the camera.

**End IP Address:** The ending IP address of the IP address range for the devices (such as a computer) that have permission to access the video of the camera. Click **Add** to save your changes.

**Delete Allow List:** Select an entry to remove from the Allow List, then click **Delete**.

**Deny List:** The list of IP addresses that have no access rights to the camera.

**Start IP Address:** The starting IP address of the IP address range for the devices (such as a computer) that will be denied access to the camera.

**End IP Address:** The ending IP address of the IP address range for the devices (such as a computer) that will be denied access to the camera. Click **Add** to save your changes.

**Delete Deny List:** Select an entry to remove from the Deny List, then click **Delete**.

**Note:** All addresses in the Deny List will be denied access, even if they are also in the Allow List.

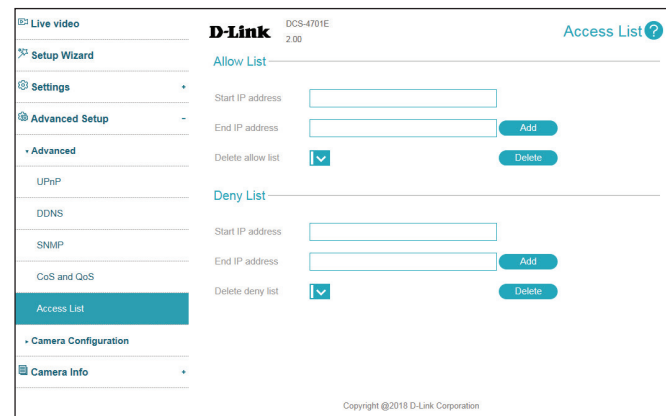

## Camera Configuration

### Save and Load Configuration

In this section, you may back up or restore the camera configuration.

**Save To Local Hard Drive:** You may save your current camera configuration as a file on your computer.

**Load From Local Hard Drive:** Locate a pre-saved configuration by clicking **Browse** and then restore the pre-defined settings to your camera by clicking **Load Configuration**.

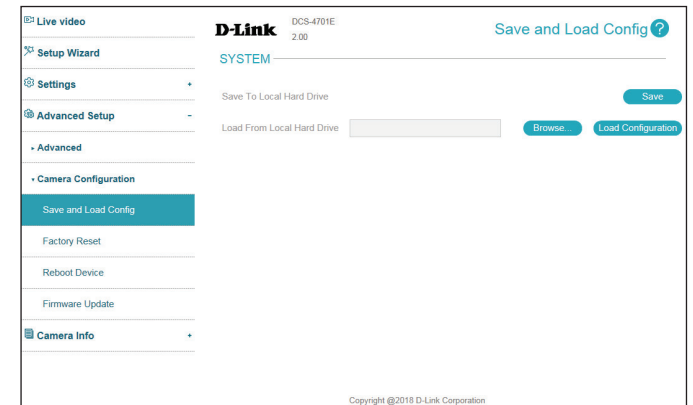

## Factory Reset

Here you can reset the camera configuration back to the factory defaults.

**Restore to Factory Default:** You may reset your camera and restore the factory settings by clicking **Restore Factory Defaults**.

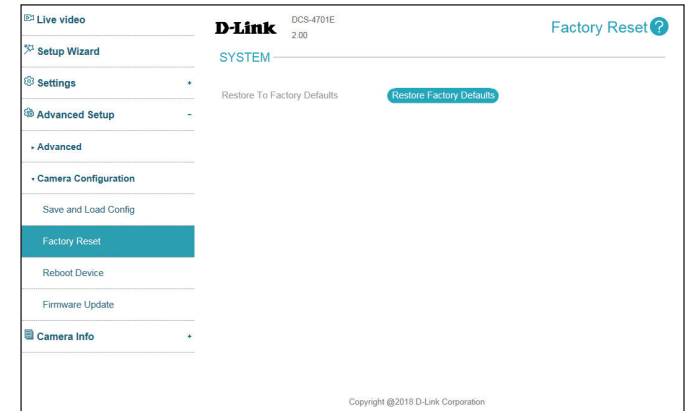

## Reboot Device

Here you can reboot the camera, or set a schedule to reboot the camera automatically.

**Reboot Device:** This will restart your camera.

**Schedule Reboot:** If you want your camera to reboot on a regular schedule, enable this option, then select the days and time you want the camera to reboot on and click the **Save** button.

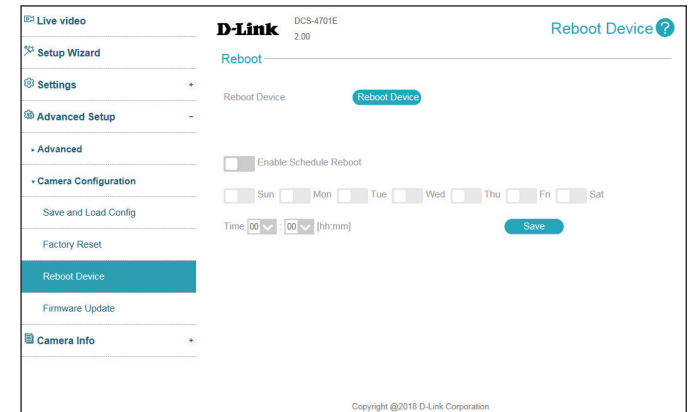



## Firmware Update

Here you can update the camera's firmware. The current version of the firmware is shown next to the D-Link logo at the top of the page.

**File Path:** To update the firmware, select a firmware file to use from your hard drive by clicking **Browse...**, then click the **Upload** button.

**Note:** While the firmware is being updated, do not close the web browser or disconnect your camera's power or network connection until the update is complete.

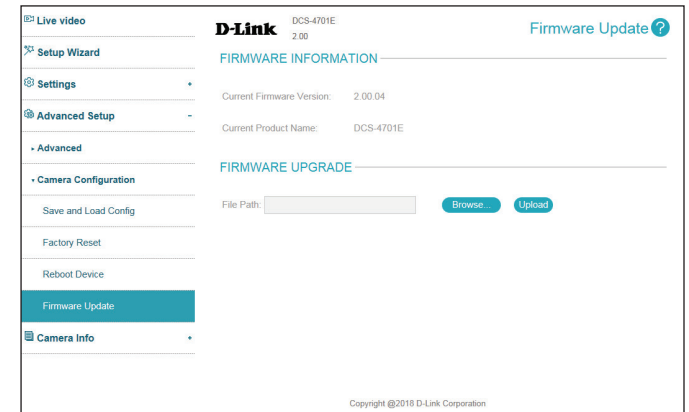

# Camera Options

## Camera Info

This page displays detailed information about your camera, the services running on your camera, and active video streams.

Live video

Setup Wizard

Settings +

Advanced Setup +

Camera Info -

**D-Link** DCS-4701E  
2.00

Camera Info

---

**Camera Info**

Camera Info

▸ Time

▸ Administration Settings

System Log

INFORMATION

IP Camera Name	DCS-4701E
Time & Date	Fri Mar 9 1:52:3 2018
Firmware Version	2.00.04
Hardware Version	B
MAC Address	00:CA:83:71:00:02
IP Address	192.168.1.101
IP Subnet Mask	255.255.255.0
Default Gateway	192.168.1.1
Primary DNS	192.168.168.250
Secondary DNS	192.168.168.201

Copyright ©2018 D-Link Corporation

## Time Time Settings

This section allows you set the time zone and Daylight Saving settings for your camera.

**Time Zone:** Select your time zone from the drop-down menu.

**Daylight Saving:** If your region uses Daylight Saving time, you can enable it here. Select Set date and time manually if you want to manually set the offset and the period of time that the Daylight Saving correction should be used.

**Offset:** Enter the offset that should be used when Daylight Saving is being used.

**Start Time:** Set the date and time that Daylight Saving should start.

**End Time:** Set the date and time that Daylight Saving should end.

The screenshot displays the 'Time Settings' page for a D-Link DCS-4701E camera. The page is titled 'TIME CONFIGURATION' and features a sidebar on the left with navigation options. The main content area includes the following settings:

- Time Zone:** A dropdown menu set to '(GMT) Coordinated Universal Time'.
- Enable Daylight Saving:** A toggle switch that is currently turned off.
- Auto Daylight Saving:** A radio button that is currently unselected.
- Set date and time manually:** A radio button that is currently selected.
- Offset:** A dropdown menu set to '+02:00'.
- Start time:** Fields for Month (1), Week (1), Day of week (Sunday), Hour (0), and Minutes (0).
- End time:** Fields for Month (1), Week (1), Day of week (Sunday), Hour (0), and Minutes (0).

A 'Save' button is located at the bottom right of the settings area. The footer of the page reads 'Copyright ©2018 D-Link Corporation'.

## Auto Time Config

This section lets you set your camera's date and time automatically by using an NTP server.

**NTP Server:** Enable this option to set your camera's time using an NTP server, then select an NTP server to use from the drop-down box.

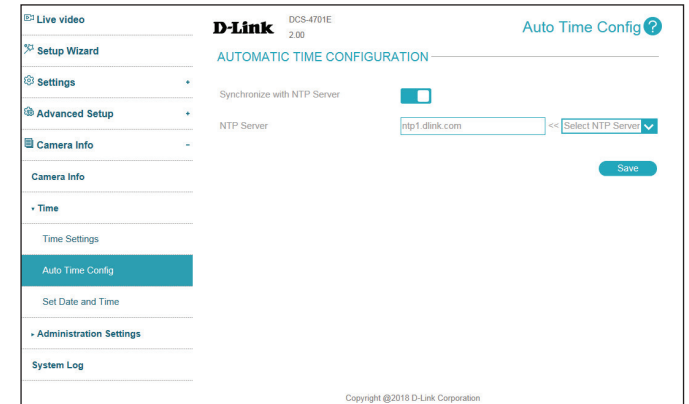

## Set Date and Time

This section lets you manually set your camera's date and time. If you have **NTP Server** enabled in **Auto Time Config**, you will need to disable it before setting the date and time manually.

**Set Date and Time Manually:** Enable this option to manually set the time and date.

**Copy Your PC's Time:** This will synchronize the time information with your PC.

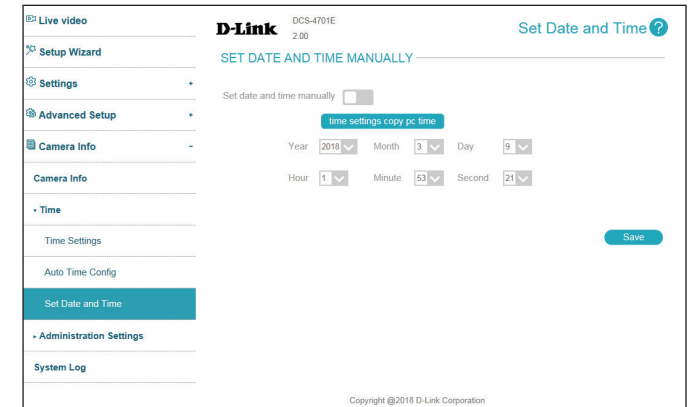

# Administration Settings

## Admin Password

Here, you may modify the administrator's password for your camera.

**New Password / Retype Password:** Set a new password for the administrator's account.

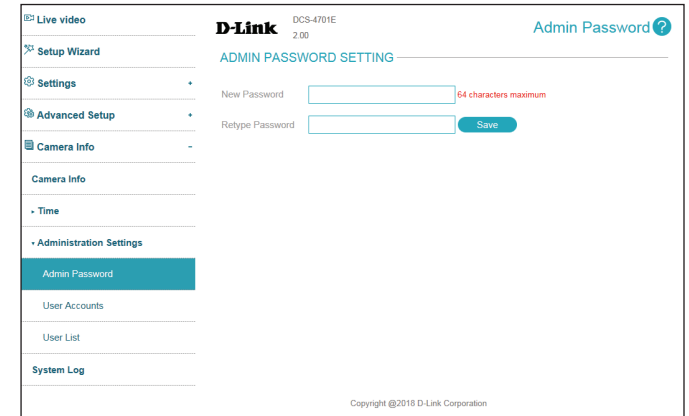

## User Accounts

Here, you may add user accounts for accessing the camera. User accounts are allowed to access the Live Video page, but cannot access any of the camera's configuration pages.

**User Name:** Enter a user name for the user you wish to create.

**New Password / Retype Password:** Enter a password for the user you wish to create.

The screenshot shows the 'ADD USER ACCOUNT' page in the D-Link DCS-4701E web interface. The page has a sidebar on the left with navigation options: Live video, Setup Wizard, Settings, Advanced Setup, Camera Info, Camera Info, Time, Administration Settings, Admin Password, User Accounts (highlighted), User List, and System Log. The main content area is titled 'ADD USER ACCOUNT' and contains three input fields: 'User Name' (with a red note '17 users maximum'), 'New Password' (with a red note '64 characters maximum'), and 'Retype Password'. An 'Add' button is located to the right of the 'Retype Password' field. The top of the page displays 'D-Link DCS-4701E 2.00' and a 'User Accounts' link with a question mark icon. The footer contains the text 'Copyright ©2018 D-Link Corporation'.

## User List

Here, you may manage the user accounts for accessing the camera.

**User Name:** If you want to change a user's password, select a user from the drop-down box, enter the new password, then click the **Modify** button.

If you want to remove a user from the user list, select a user from the drop-down box, then click the **Delete** button.

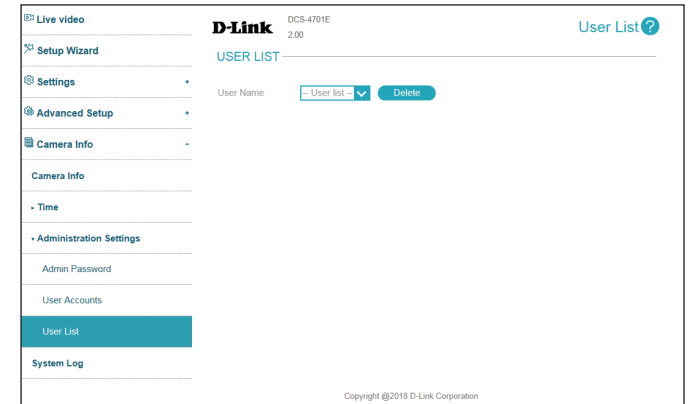



## Camera Log

This page displays the log information of your camera. You may download the information by clicking **Download**. You may also click **Clear** to delete the saved log information.

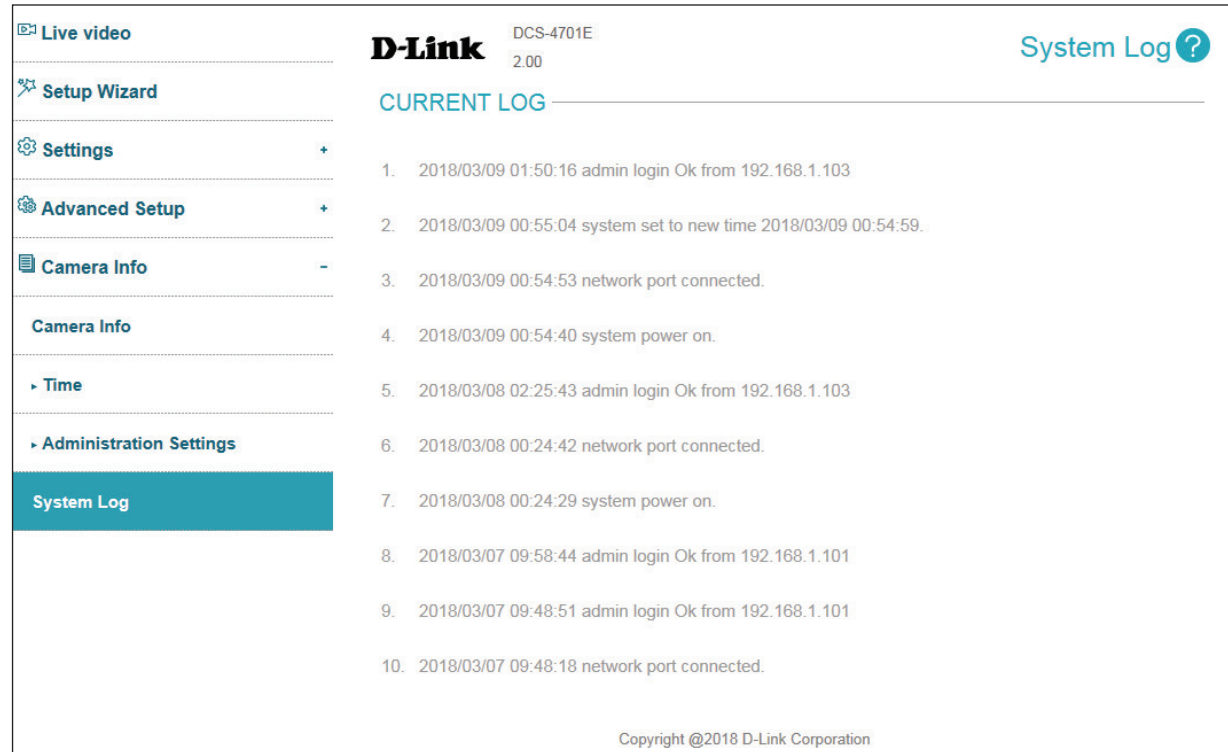

**D-Link** DCS-4701E 2.00 System Log ?

**CURRENT LOG**

1. 2018/03/09 01:50:16 admin login Ok from 192.168.1.103
2. 2018/03/09 00:55:04 system set to new time 2018/03/09 00:54:59.
3. 2018/03/09 00:54:53 network port connected.
4. 2018/03/09 00:54:40 system power on.
5. 2018/03/08 02:25:43 admin login Ok from 192.168.1.103
6. 2018/03/08 00:24:42 network port connected.
7. 2018/03/08 00:24:29 system power on.
8. 2018/03/07 09:58:44 admin login Ok from 192.168.1.101
9. 2018/03/07 09:48:51 admin login Ok from 192.168.1.101
10. 2018/03/07 09:48:18 network port connected.

Copyright ©2018 D-Link Corporation

# Technical Specifications

Technical Specifications		
Camera		
Camera Hardware Profile	<ul style="list-style-type: none"> <li>• 1/2.7" 2-megapixel progressive CMOS sensor</li> <li>• 30 meter IR illumination distance</li> <li>• Minimum illumination:               <ul style="list-style-type: none"> <li>• 0.1 lux (color)</li> <li>• 0.05 lux (B/W)</li> <li>• 0 lux (IR LED on)</li> </ul> </li> <li>• Built-in Infrared-Cut Removable (ICR) Filter module</li> <li>• 10x digital zoom</li> <li>• Minimum object distance 0.5 m</li> </ul>	<ul style="list-style-type: none"> <li>• Focal length: 3.6 mm</li> <li>• Aperture: F1.8</li> <li>• Angle of view:               <ul style="list-style-type: none"> <li>• (H) 90°</li> <li>• (V) 50°</li> <li>• (D) 104°</li> </ul> </li> </ul>
Camera Housing	<ul style="list-style-type: none"> <li>• IP66 compliant weatherproof housing</li> </ul>	<ul style="list-style-type: none"> <li>• Wire-in bracket</li> </ul>
Image Features	<ul style="list-style-type: none"> <li>• Configurable image size, quality, frame rate, and bit rate</li> <li>• Time stamp and text overlays</li> <li>• Configurable motion detection windows</li> <li>• Configurable privacy mask zones</li> </ul>	<ul style="list-style-type: none"> <li>• Configurable shutter speed, brightness, saturation, contrast, and sharpness</li> <li>• WDR</li> <li>• 3D filter</li> </ul>
Video Compression	<ul style="list-style-type: none"> <li>• Simultaneous H.265/H.264/MJPEG format compression</li> <li>• H.265/H.264/MJPEG multicast streaming</li> </ul>	<ul style="list-style-type: none"> <li>• JPEG for still images</li> </ul>
Video Resolution	<ul style="list-style-type: none"> <li>• 16:9 - 1920 x 1080, 1280 x 720, 800 x 448, 640 x 480 up to 30 fps</li> </ul>	<ul style="list-style-type: none"> <li>• 4:3 - 1440 x 1080, 900 x 720, 800 x 592, 640 x 480 up to 30 fps</li> </ul>
External Device Interface	<ul style="list-style-type: none"> <li>• 10/100 BASE-TX Fast Ethernet port</li> </ul>	<ul style="list-style-type: none"> <li>• Supports 802.3af PoE</li> </ul>
Network		
Network Protocols	<ul style="list-style-type: none"> <li>• IPv6</li> <li>• IPv4</li> <li>• TCP/IP</li> <li>• UDP</li> <li>• ICMP</li> <li>• DHCP client</li> <li>• NTP client (D-Link)</li> <li>• DNS client</li> <li>• DDNS client (D-Link)</li> <li>• SMTP client</li> </ul>	<ul style="list-style-type: none"> <li>• FTP client</li> <li>• HTTP / HTTPS</li> <li>• Samba client</li> <li>• PPPoE</li> <li>• UPnP port forwarding</li> <li>• RTP / RTSP / RTCP</li> <li>• IP filtering</li> <li>• Multicast</li> <li>• SNMP</li> <li>• ONVIF compliant</li> </ul>
Security	<ul style="list-style-type: none"> <li>• Administrator and user group protection</li> <li>• Password authentication</li> </ul>	<ul style="list-style-type: none"> <li>• HTTP and RTSP authentication</li> </ul>

## Appendix A: Technical Specifications

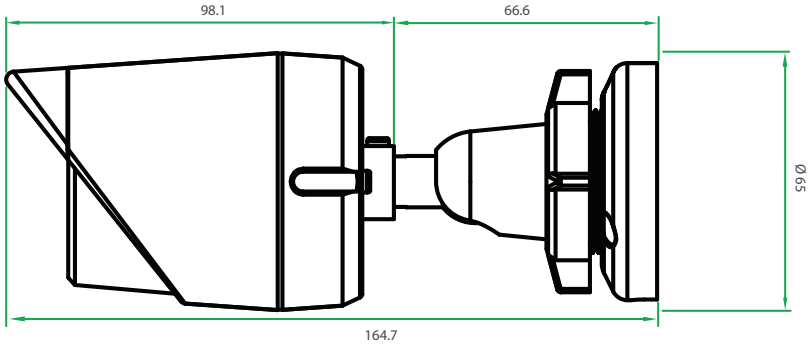
System Management		
Event Management	<ul style="list-style-type: none"> <li>• Motion detection</li> <li>• Event notification and uploading of snapshots/video clips via e-mail or FTP</li> </ul>	<ul style="list-style-type: none"> <li>• Supports multiple SMTP and FTP servers</li> <li>• Multiple event notifications</li> <li>• Multiple recording methods for easy backup</li> </ul>
Remote Management	<ul style="list-style-type: none"> <li>• Remote management via D-ViewCam™ software</li> <li>• Configuration interface accessible via web browser</li> </ul>	<ul style="list-style-type: none"> <li>• Remotely take snapshots/video clips and save to local hard drive</li> </ul>
System Requirements for Web Interface	<ul style="list-style-type: none"> <li>• Windows 10/8/7 or Mac OS X 10.9 and higher</li> </ul>	<ul style="list-style-type: none"> <li>• Internet Explorer 9 and higher (on Windows), Firefox 12-51, 52 ESR, Chrome 42 and higher, or Safari 9 and higher (on Mac OS X).</li> </ul>
D-ViewCam™ System Requirements	<ul style="list-style-type: none"> <li>• Operating System: <ul style="list-style-type: none"> <li>• 32-bit: Windows 8 / 7 (SP1)</li> <li>• 64-bit: Windows 10 / 8 / 7 (SP1) / Server 2012 / Server 2008 R2</li> </ul> </li> </ul>	<ul style="list-style-type: none"> <li>• Web Browser: Internet Explorer 7 or higher</li> <li>• Protocol: Standard TCP/IP</li> </ul>
D-ViewCam™ Software Functions	<ul style="list-style-type: none"> <li>• Remote management of up to 32 cameras</li> <li>• Supports all management functions provided in web interface</li> </ul>	<ul style="list-style-type: none"> <li>• Viewing of up to 32 cameras on one screen</li> <li>• Scheduled, motion triggered, or manual recording options</li> </ul>
General		
Weight	• 445 g ± 5 %	
External Power Adapter	• Input: 100 to 240 V AC, 50/60 Hz	• Output: 12 V DC 1.5 A
Power Consumption	• 3.2 (DC) / 3.1 W (PoE) ± 5%	
Temperature	• Operating: -30 to 50 °C (-22 to 122 °F)	• Storage: -20 to 70° C (-4° to 158° F)
Humidity	• Operating: 20 % to 80 % non-condensing	• Storage: 5 % to 95 % non-condensing
Certifications	<ul style="list-style-type: none"> <li>• CE</li> <li>• CE LVD</li> </ul>	<ul style="list-style-type: none"> <li>• FCC</li> <li>• C-Tick</li> </ul>
Dimensions	 <p>Technical drawing of the D-Link DCS-4701E camera showing dimensions: 98.1 mm (width), 66.6 mm (depth), 164.7 mm (total length), and Ø55 mm (diameter).</p>	