



User Manual

Vigilance H.265 Outdoor Bullet Camera

DCS-4712E
DCS-4714E
DCS-4718E

Preface

D-Link reserves the right to revise this publication and to make changes in the content hereof without obligation to notify any person or organization of such revisions or changes. Information in this document may become obsolete as our services and websites develop and change.

Manual Revisions

Revision	Date	Description
1.00	01/25/2021	Initial release
1.10	04/16/2021	Hardware Overview update

Trademarks

D-Link and the D-Link logo are trademarks or registered trademarks of D-Link Corporation or its subsidiaries in the United States or other countries. All other company or product names mentioned herein are trademarks or registered trademarks of their respective companies.

Copyright © 2021 D-Link Corporation.

All rights reserved. This publication may not be reproduced, in whole or in part, without prior expressed written permission from D-Link Corporation.

Table of Contents

Product Overview.....	4	Advanced.....	51
Package Contents.....	4	Camera Configuration.....	58
Introduction.....	5	Camera Options	61
System Requirements	5	Camera Info.....	61
Features.....	6	Date and Time.....	62
Hardware Overview (DCS-4712E/DCS-4714E)	7	Administration Settings	63
Hardware Overview (DCS-4718E)	8	Camera Log	65
Installation.....	9	Camera Log / Alarm	66
Mounting the Camera.....	9	Technical Specifications - DCS-4712E	69
Waterproofing Your Installation	11	Technical Specifications - DCS-4714E	71
Inserting the MicroSD Card.....	14	Technical Specifications - DCS-4718E	73
Configuration	15	Regulatory Information	75
Installing the Setup Wizard	15		
Accessing the Admin Interface.....	16		
Live Video	17		
Playback.....	18		
Controlling the Playback.....	19		
Setup Wizard	21		
Network Setup Wizard	22		
Motion Detection Setup Wizard.....	28		
Settings	33		
Network Settings	33		
Camera Settings	38		
Advanced Setup.....	51		

Product Overview

Package Contents



Vigilance H.265 Outdoor Bullet Camera



Cable Waterproofing Connector

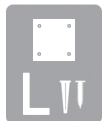

Mounting Kit

- Allen Key
- Alignment Sticker



Documentation

If any of the above items are missing, please contact your reseller.

Safety Notice: Installation and servicing should be done by certified technicians to conform with all local codes and prevent voiding your warranty.

Introduction

The Vigilance H.265 2/4/8 Megapixel Outdoor Bullet Camera is a professional surveillance and security solution for small, medium, and large enterprises. It uses a full-HD progressive scan CMOS sensor to deliver low-noise video and low-light capability ideal for surveillance applications. It offers a complete surveillance solution featuring a built-in IR cut filter and IR LEDs effective up to 30 meters with built-in smart IR function, avoiding overexposure of near objects at night, allowing it to stream simultaneous real-time full-HD resolution video 24/7. In addition, the IP66 certified weatherproof housing make this camera ideal for both indoor and outdoor applications.

To maximize bandwidth efficiency and improve image quality, it provides real-time video compression using H.265, H.264, and MJPEG codecs for simultaneous video streaming and recording. It also incorporates Power over Ethernet (PoE), allowing it to be easily installed in a variety of locations, especially with D-Link Surveillance Switches.

This camera can be accessed remotely, controlled, and configured from any computer over your local network or through the Internet via a web browser. The simple installation and intuitive web-based interface offer easy configuration across the full range of its advanced feature set and make it an ideal choice for a dependable and cost-effective surveillance solution with easy clutter-free installation.

System Requirements

- Computer running Microsoft Windows® 10
- Internet Explorer 11, Google Chrome or Firefox (MJPEG only)

Features

H.265/H.64 Compression

This camera supports the H.265 and H.264 compression algorithms to bring out the best combination of performance, quality, bandwidth, and storage space.

Better Night Vision

Supports night vision technology from Sony which optimizes the display for increased image quality in low-light environments.

microSD Card

The camera comes equipped with an optional microSD card slot for local storage. Recordings can be saved to the microSD card.

IR LEDs for Day and Night Functionality

The built-in infrared LEDs enable night time viewing of up to 30 meters. With built-in smart IR function, it can avoid overexposure of near objects at night.

IP66 Weatherproof and Vandal-Proof Housing

This camera uses IP66 weatherproof housing, allowing you to rest assured that in the toughest of conditions, it will continue to provide round-the-clock surveillance.

PoE (Power over Ethernet) for Flexible Installation

Your camera can draw all the power it needs from a PoE switch or PoE injector for a simple and clutter-free installation. You can also power it with an optional 12 V / 1.5 A power adapter.

Remote Monitoring Utility

The D-Link D-ViewCam™ application adds enhanced features and functionality for the camera and allows administrators to configure and access the camera from a separate site via Intranet or Internet. Other features include image monitoring, recording images to a hard drive, viewing up to 64 cameras on one screen, and taking snapshots.

Hardware Overview (DCS-4712E/DCS-4714E)

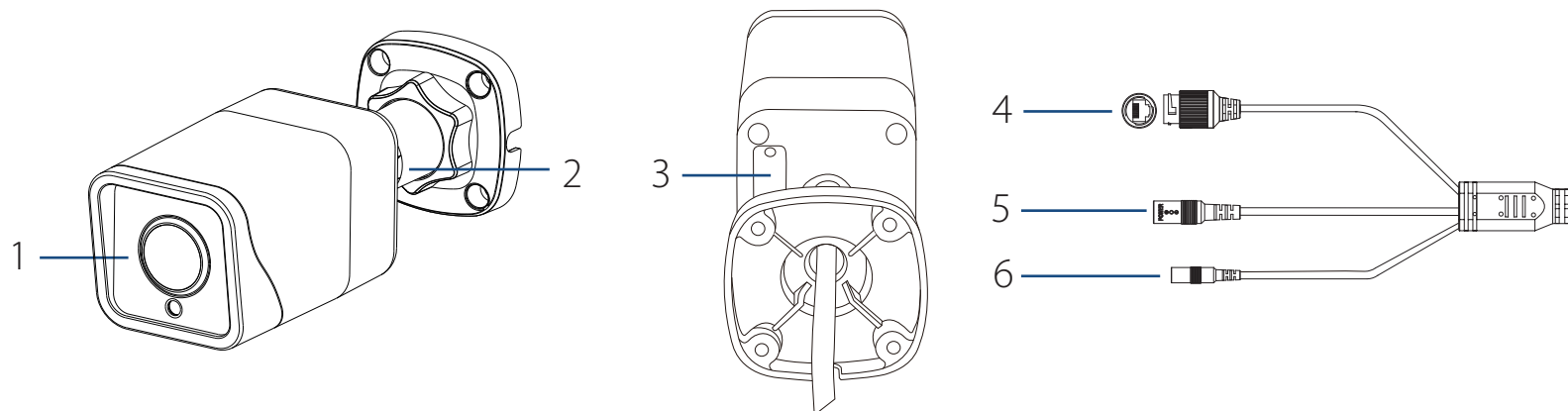

1	Camera Lens	Fixed camera lens.
2	Adjustment Mount	Loosen the screw with the included Allen key to adjust the camera angle. Tighten it to lock the camera angle.
3	microSD Slot	Slot for a microSD card.
4	Ethernet Jack	RJ-45 connector for Ethernet. Can also be used to power the camera using Power over Ethernet (PoE).
5	Power Connector	Connects to an optional 12 V / 1.5 A power adapter (not included).
6	Reset Button	Press and hold for more than five seconds, then release to perform a factory reset.

Hardware Overview (DCS-4718E)

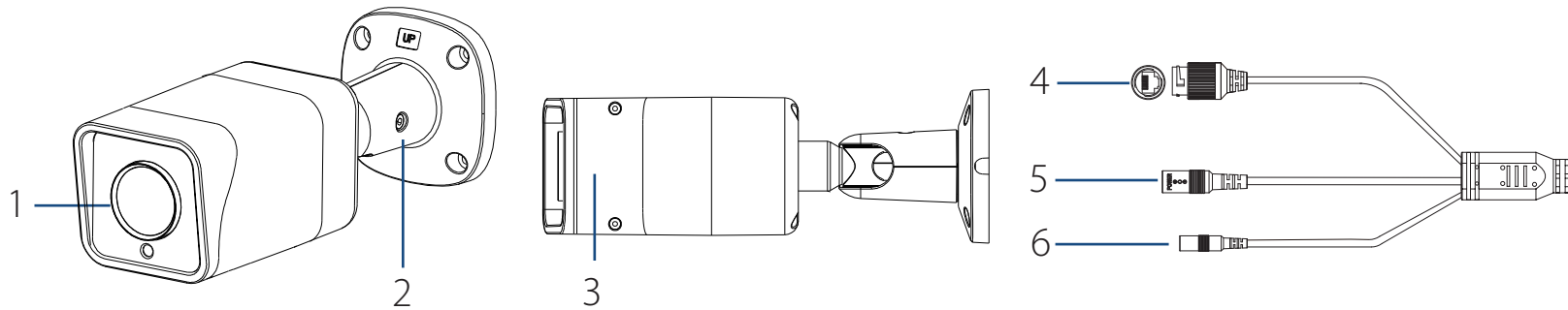

1	Camera Lens	Motorized vari-focal lens.
2	Adjustment Mount	Loosen the screw with the included Allen key to adjust the camera angle. Tighten it to lock the camera angle.
4	microSD Slot	Slot for a microSD card.
5	Ethernet Jack	RJ-45 connector for Ethernet. Can also be used to power the camera using Power over Ethernet (PoE).
6	Power Connector	Connects to an optional 12 V / 1.5 A power adapter (not included).
7	Reset Button	Press and hold for more than five seconds, then release to perform a factory reset.

Installation

Mounting the Camera

It is highly recommended that you configure and test your camera before mounting it. Refer to **"Inserting the microSD Card" on page 14** and **"Installing the Setup Wizard" on page 15** for more information.

Step 1

Place the mounting sticker where you want to position the camera.

Use a 4 mm drill bit to make the required holes approximately 30 mm deep, then insert the wall anchors into the holes.

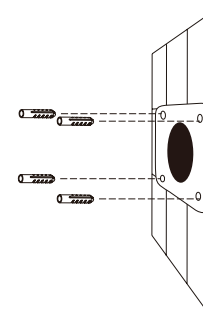

Step 2

If you are running the camera cables out the side of the camera, guide the camera cables through the cable channel on the base.

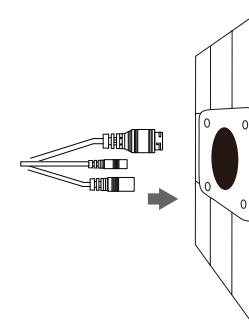

Step 3

Use the screws provided to mount the camera to the wall.

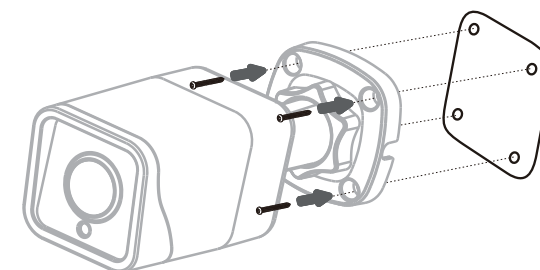

Step 4

Connect the power and Ethernet cables, or just the Ethernet cable if you are using a PoE connection.

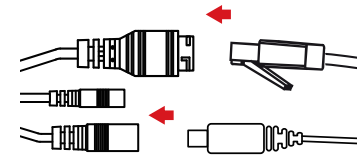

Step 5

To adjust the camera's monitoring direction, use the Allen key to turn the adjustment screw counterclockwise to loosen it, then move the camera to the desired position and angle. When you are finished, turn the adjustment screw clockwise to tighten it.

Waterproofing Your Installation

To waterproof your camera, follow the instructions below. A round Ethernet cable, a crimping tool, and RJ-45 plugs are required for this procedure.

Step 1

Place the washer around the base of the Ethernet connector as shown.

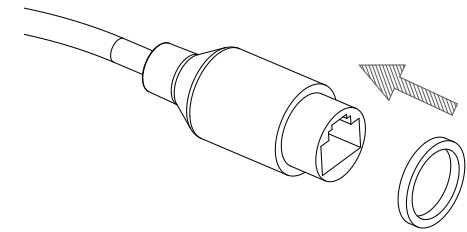

Step 2

Thread the bare Ethernet cable through the waterproof connector as shown, then crimp an RJ-45 plug onto the cable.

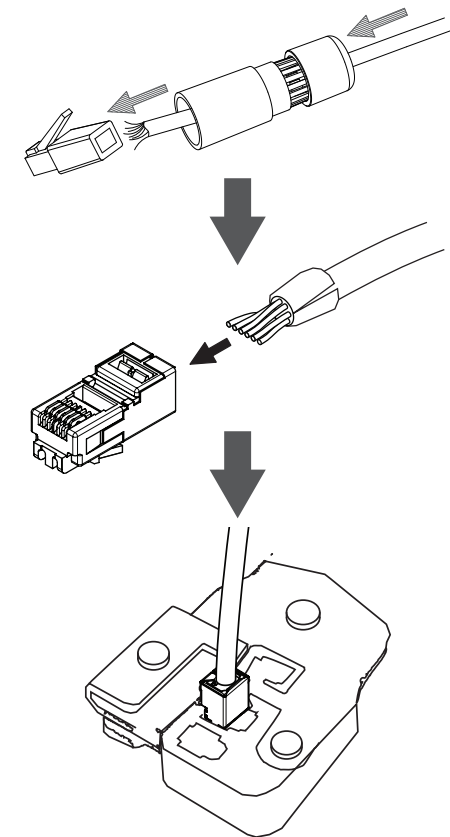

Step 3

Connect the RJ-45 plug into the Ethernet connector, then screw the waterproof connector to the Ethernet connector by turning it about a half-turn clockwise.

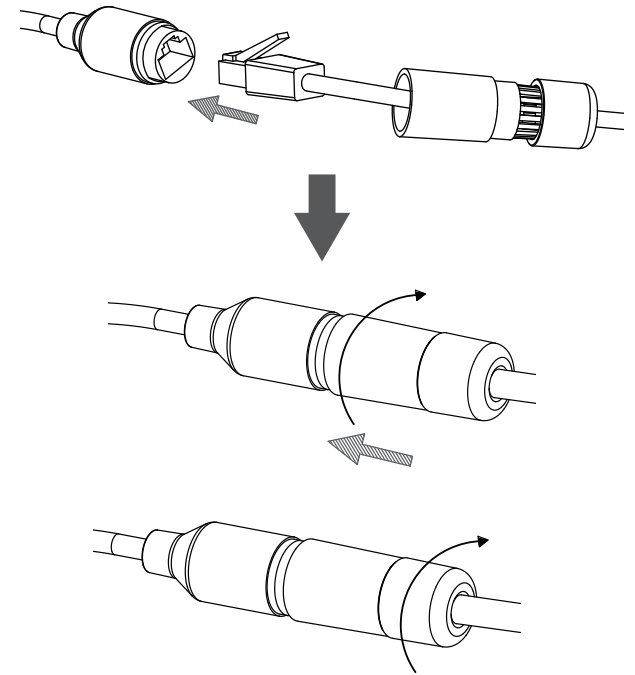

Step 4

Screw the back part of the waterproof connector clockwise until there is a tight seal around the Ethernet cable.

Step 5

The power connector and reset button cables are not waterproof. It is recommended to use waterproof tape to protect them. Wind the tape around each cable in an overlapping manner to cover them.

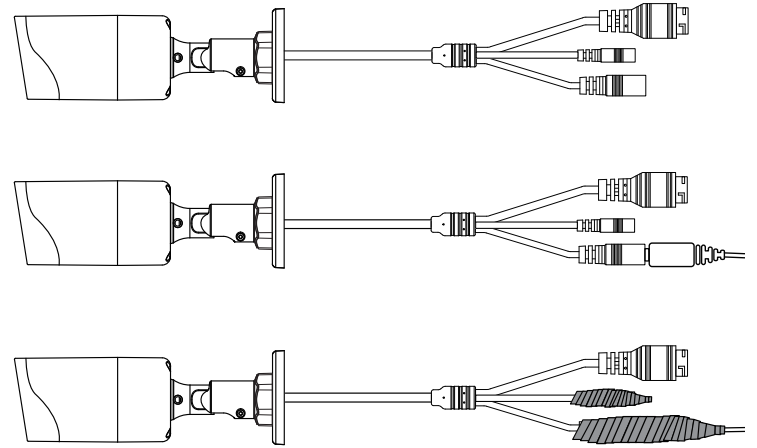

Inserting the microSD Card

You can insert an (optional) microSD card to store recordings. To insert the microSD card, first remove the screws from the small panel on the back of the camera (for the DCS-4712E/DCS-4714E) or the bottom of the camera (for the DCS-4718E). Open the panel, insert a microSD card into the slot, and replace the panel and the screws.

DCS-4712E/DCS-4714E

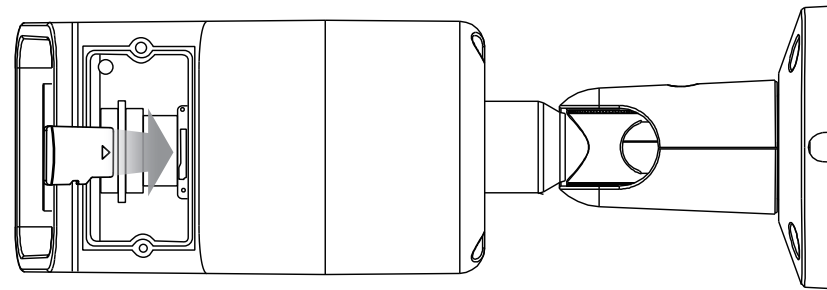
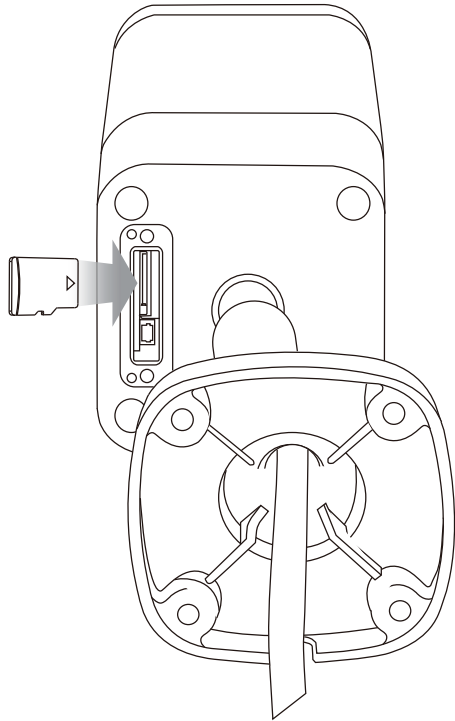

DCS-4718E

Configuration

Installing the Setup Wizard

1. Using a web browser, navigate to **dlink.com/support/** and select your region.
2. On the next screen, enter the model number of your camera in the search bar and click **Search**. Click the picture of your camera. On the product page, click the **Download** button next to **Setup Wizard**.
3. Once the executable file has finished downloading, click it and follow the instructions to install the Setup Wizard.

Accessing the Admin Interface

1. Ensure that your camera is plugged in (either using a 12V 1.5 A power adapter or a PoE-enabled device) and connected to your computer with an Ethernet cable.
2. Open the Setup Wizard. It will display the MAC address and IP address of your camera. If you have a DHCP server on your network, this will be a dynamic IP address. If your network does not use a DHCP server, the network camera's default static IP **192.168.0.20** will be displayed. Select your camera, then click the **Link** button to continue.
3. If this is your first time logging in, you will be prompted to create a password, which must be between 8 and 30 characters and must contain both letters and numbers. Press **Saves**.
4. To view the camera display and configure the camera, on the main screen of the Setup Wizard, click the **Search** button, then select your camera and click the **Link** button to open the Web UI. Alternatively, open a web browser and type the camera's IP address (displayed in step 2) into the URL bar and press **Enter**.
5. Enter the password you created, and click **Login** to continue.



New Password

Confirm New Password

Password

[Administrator | Other User](#)

Live Video

On the Home screen, you can view the camera display and use the icons at the top of the screen to navigate to different pages of the web UI. The icons are:



Setup: Clicking this will take you to the camera configuration pages.



Playback: Click this to view saved recordings.



Video Stream: Select a video profile to use. For more on setting up video profiles, refer to **Video Stream** on page 45.



Snapshot: This will save a snapshot to your PC using the storage folder you have selected.



Record: This will start recording a video clip to a selected folder on your computer.



Select a Folder: Select a storage folder to save snapshots and video clips to.



Alarm: This will flash red when motion is detected.



Recording Status: This will turn red when the camera is recording.



Logout: Click this to log out of the web interface.

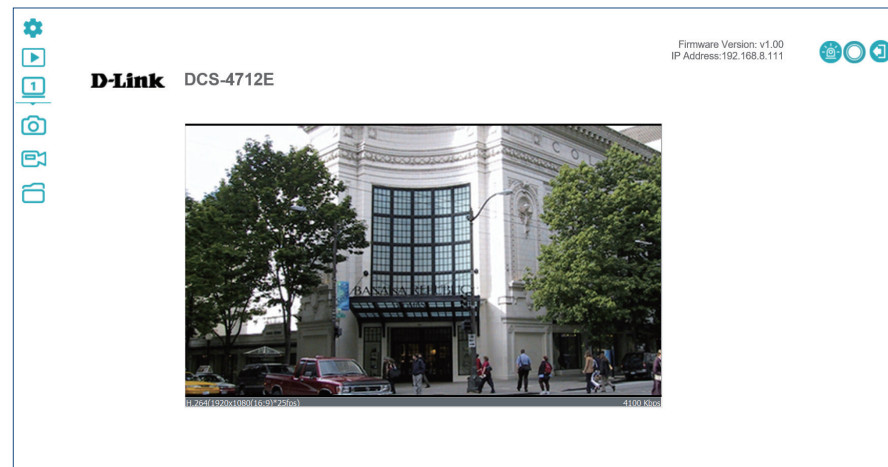

Playback

On this page you can view recorded video stored on your camera's microSD card. Use the buttons below the image to control the playback, and use the bar below the buttons to select which period of time you would like to view recordings from.

D-Link DCS-4712E

Firmware Version: v1.00
IP Address: 192.168.8.111

Displays the video playback

Controls the playback

Display the date and time by adjusting the start/end time settings.

Use this to select the date and time to play the recording from

Controlling the Playback

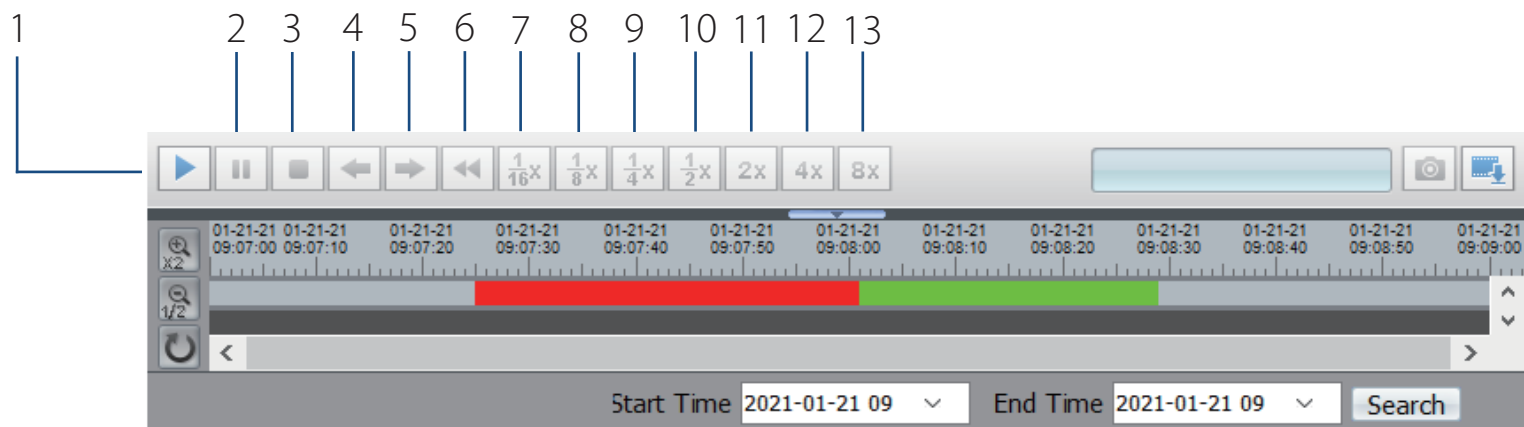

1	Play	Play the recording from the selected location.
2	Pause	Pause the playback.
3	Stop	Stop the playback.
4	Frame back	Step back a frame
5	Frame play	Step forward a frame
6	Go back	Play in reverse
7	1/16x speed	Play at 1/16x speed.
8	1/8x speed	Play at 1/8x speed.
9	1/4x speed	Play at 1/4x speed.
10	1/2x speed	Play at 1/2x speed.
11	2x speed	Play at 2x speed.
12	4x speed	Play at 4x speed.
13	8x speed	Play at 8x speed.

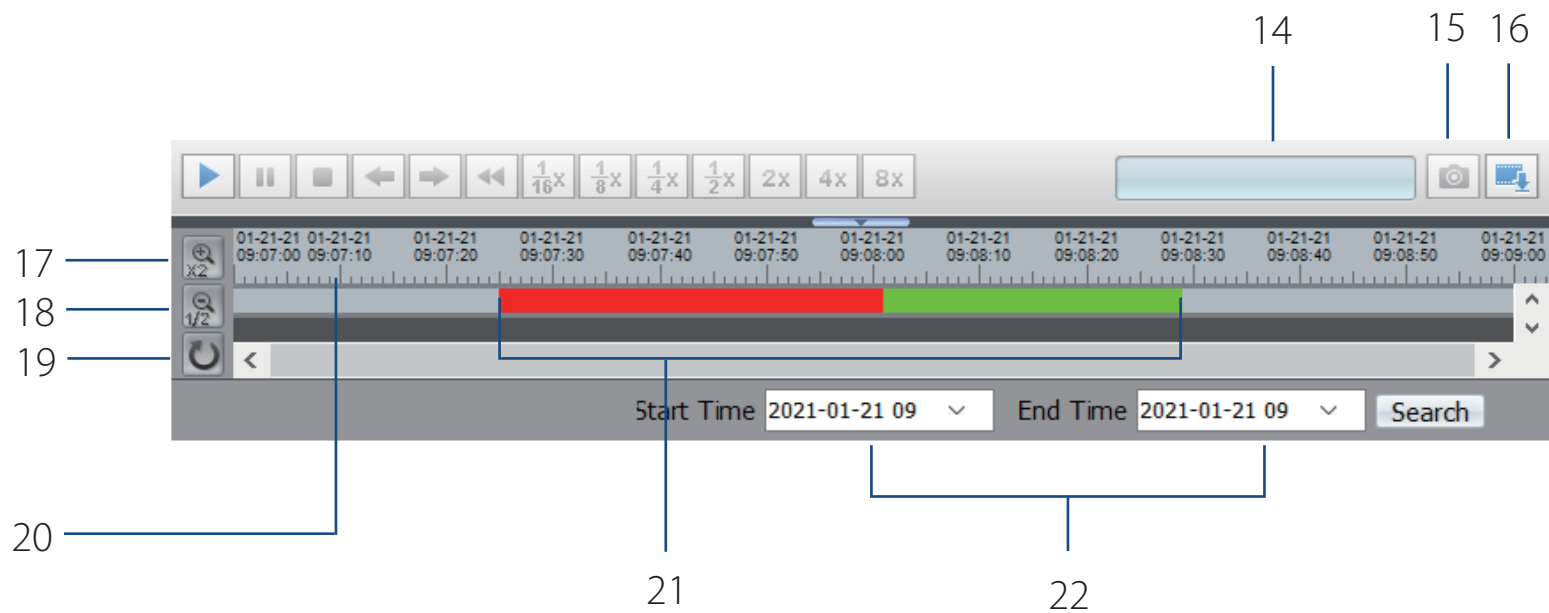

14	Current Time	Displays the current playback time.
15	Snapshot	Take a snapshot of the current frame.
16	Backup	Display the backup file. To back up the video, click the right mouse button and select the desired date/time range to back up.
17	Zoom In	Narrow the range of dates being displayed.
18	Zoom Out	Widen the range of dates being displayed.
19	Default	Reset the zoom settings to the default view.
20	Select Date and Time	Click this bar to start the playback from a particular date and time.
21	Video File Indicator	A red bar indicates recording triggered by a motion alarm, a green bar indicates scheduled recording.
22	Select Time	Select a range of dates and times to view in the bar above.

Setup Wizard

On this screen you can access your camera's two Setup Wizards.

The **Network Setup Wizard** will walk you through configuring your camera on your local network.

The **Motion Detection Setup Wizard** will walk you through setting an alarm to trigger when a motion detection event occurs.

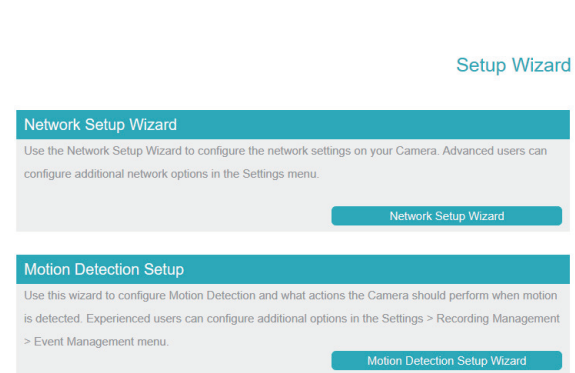

Network Setup Wizard

You can use this wizard to set up your camera on your network. For more information on each step, refer to the following pages.

Step 1: Configure LAN Settings

Step 2: Configure Dynamic DNS

Step 3: Assign a Name to the Camera

Step 4: Set your Camera's Time Zone

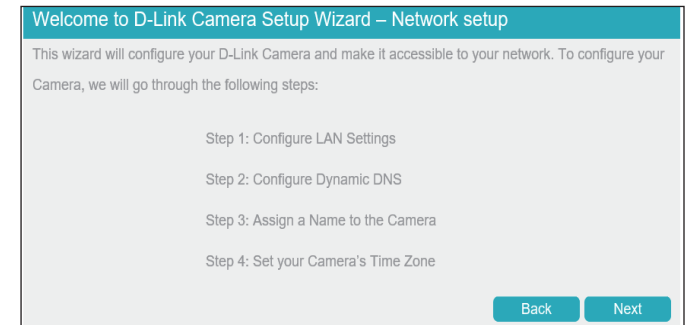

Step 1: Configure LAN Settings

DHCP Select this connection if you have a DHCP server running on your network and would like your camera to obtain an IP address automatically.

If you choose DHCP, you do not need to fill out the IP address settings.

IP Address Enter the fixed IP address in this field.

Subnet Mask This number is used to determine if the destination is in the same subnet. The default value is **255.255.255.0**.

Default Gateway Enter the gateway used to forward frames to destinations in a different subnet. Invalid gateway settings may cause the failure of transmissions to a different subnet.

Default Router Enter the IP address of the default router.

Primary DNS Enter the primary domain name server for translating domain names to IP addresses.

MTU (1280-1500) Enter the maximum transmission unit. The default value is **1500**.

Step 1: Configure LAN Settings

Select how your Camera will connect to your network. If your Camera is connected to a router or you are unsure what settings to choose, select DHCP. Otherwise, select Static IP to configure a static IP address.

DHCP

IP Address

Subnet Mask

Default Gateway

Default Router

Primary DNS

MTU (1280-1500)

[Back](#) [Next](#)

Step 2: Configure Dynamic DNS

DDNS Check this box to enable the DDNS function.

Server IP Address Enter your DDNS server address, or select a service from the drop-down menu.

Host Name Enter the host name of the DDNS service.

User Name Enter the username or e-mail address used to connect to the DDNS service.

Password Enter the password used to connect to the DDNS service.

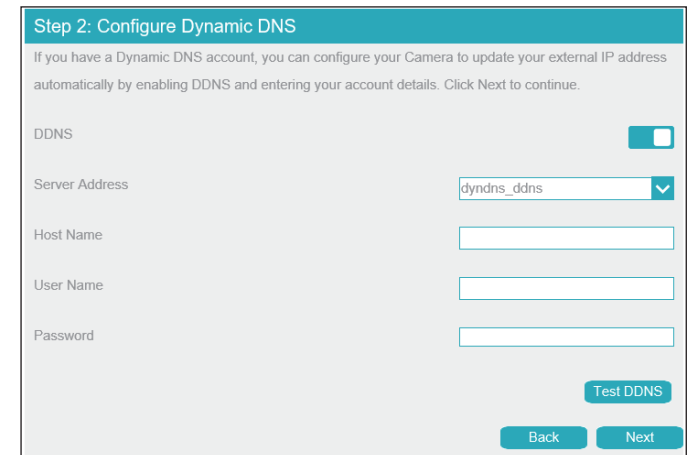

The screenshot shows a configuration page titled "Step 2: Configure Dynamic DNS". The page contains the following elements:

- A teal header bar with the title "Step 2: Configure Dynamic DNS".
- An introductory paragraph: "If you have a Dynamic DNS account, you can configure your Camera to update your external IP address automatically by enabling DDNS and entering your account details. Click Next to continue."
- A "DDNS" section with a checked checkbox.
- A "Server Address" dropdown menu with "dyndns_ddns" selected.
- Input fields for "Host Name", "User Name", and "Password".
- A "Test DDNS" button.
- "Back" and "Next" buttons at the bottom right.

Step 3: Assign a Name to the Camera

Camera Name Enter a name that will be used to identify the camera.

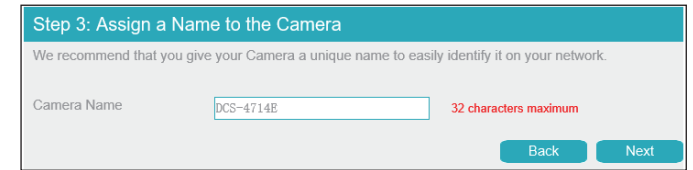

The screenshot shows a configuration window titled "Step 3: Assign a Name to the Camera". Below the title bar, there is a message: "We recommend that you give your Camera a unique name to easily identify it on your network." Below this message is a text input field labeled "Camera Name" containing the text "DCS-4714E". To the right of the input field, there is a red text label that says "32 characters maximum". At the bottom right of the window, there are two buttons: "Back" and "Next".

Step 4: Set your Camera's Time Zone

Time Zone Select your time zone.

Daylight Savings Time Toggle this to enable daylight saving time.

Start Time Select when daylight saving time should start.

End Time Select when daylight saving time should end.

The screenshot shows a configuration page titled "Step 4: Set your Camera's Time Zone". Below the title is a message: "Please set the correct time zone for your Camera to ensure that all events are triggered, captured, and scheduled correctly." The form contains the following fields:

- Time Zone:** A dropdown menu showing "(GMT) Greenwich Mean Time : Dublin, Edinburgh, I".
- Daylight Savings Time:** A toggle switch that is currently turned off.
- Start Time:** A dropdown menu showing "Mar", a date selector showing "5th", a day selector showing "Sun", and a time selector showing "1:00".
- End Time:** A dropdown menu showing "Oct", a date selector showing "5th", a day selector showing "Sun", and a time selector showing "2:00".

At the bottom right of the form are two buttons: "Back" and "Next".

Step 5: Setup Complete

Review the settings you selected and click **Finish** to complete the setup wizard process.

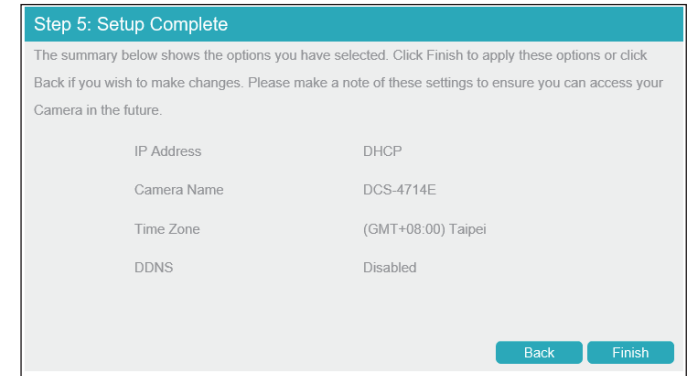

Motion Detection Setup Wizard

You can use this wizard to configure your camera's motion detection functions. For more information on each step, refer to the following pages.

Step 1: Specify Motion Detection Settings

Step 2: Alerts and Notifications

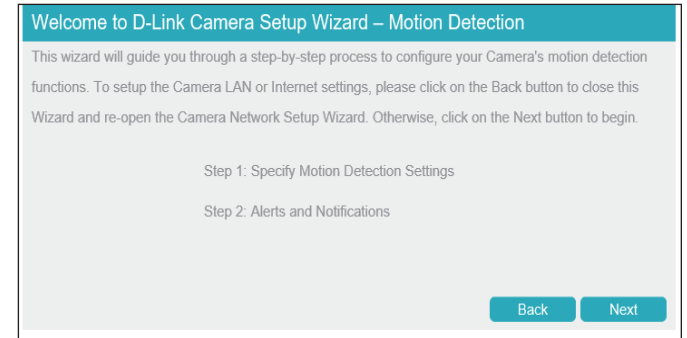

Step 1: Specify Motion Detection Settings

- Enabled** Click this to activate the motion detection alarm.
- Alarm Interval (1-1800S)** Set the alarm interval in seconds.
- Sensitivity** Set the motion detection sensitivity. A higher number indicates greater sensitivity.
- SD Card Recording** Toggle this to record video on the inserted microSD card.
- E-mail** Toggle this to send snapshots via e-mail.
- FTP Upload** Toggle this to upload snapshots via FTP.
- Show motion detection on NVR** Toggle this to display motion detection alarms on the connected NVR.

Click the schedule at the bottom to enable motion detection on a schedule.

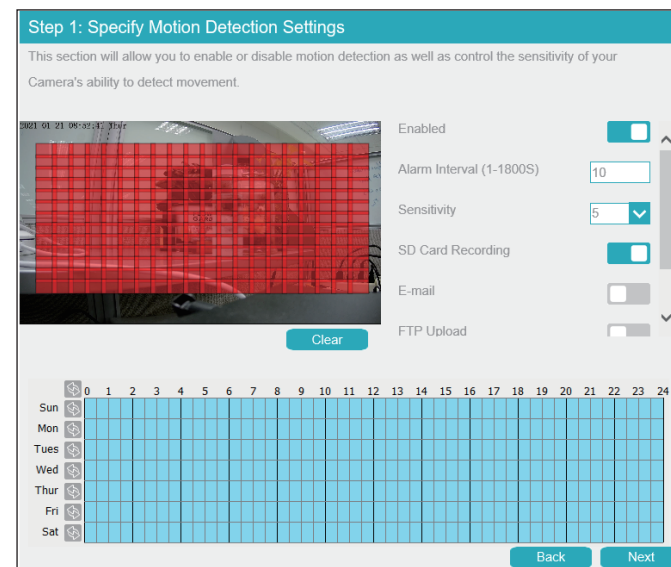

Step 2: Alerts and Notifications

E-mail Check this box to configure the camera to send snapshots to an e-mail address when a motion detection event occurs.

Server Address Enter the address of the email server.

Server Port Enter the port to use to connect to the email server.

User Name Enter the username associated with the email account.

Password Enter the password associated with the above username.

Sender E-mail Address Enter the email address that the email should be sent from.

Recipient E-mail Address Enter the recipients to send the snapshot to.

SSL/TLS Select the protocol to use to secure your email.

E-mail Test Click this to send a test email.

Step 2: Alerts and Notifications

This final step allows you to specify how you receive notification of camera events. Choose between an email notification or alternatively you can setup an FTP Notification. You will need your email account settings or FTP details. If you are unsure of this information, please contact your ISP. Once you have entered this information, please click on the Next button.

E-mail

Server Address

Server Port

User Name

Password

Sender E-mail Address

Recipient E-mail Address

SSL/TLS

[Email Test](#)

FTP Upload Check this box to configure the camera to upload snapshots to an FTP server when a motion detection event occurs.

Server IP Address Enter the address of the FTP server.

Port Enter the port to use to connect to the FTP server.

Account Enter the account to use to access the FTP server.

Password Enter the password associated with the above username.

FTP Path Enter the path to the directory where you would like your snapshots to be stored.

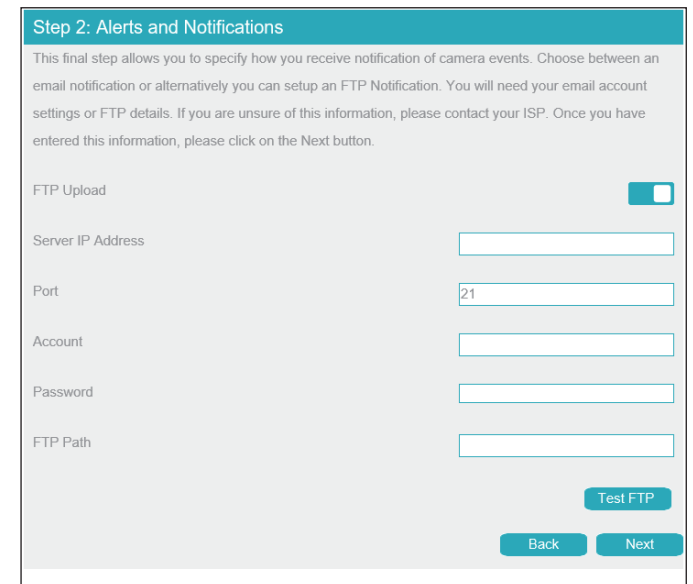

Step 2: Alerts and Notifications

This final step allows you to specify how you receive notification of camera events. Choose between an email notification or alternatively you can setup an FTP Notification. You will need your email account settings or FTP details. If you are unsure of this information, please contact your ISP. Once you have entered this information, please click on the Next button.

FTP Upload

Server IP Address

Port

Account

Password

FTP Path

[Test FTP](#)

[Back](#) [Next](#)

Step 3: Setup Complete

Review the settings you selected and click **Finish** to complete the setup wizard process.

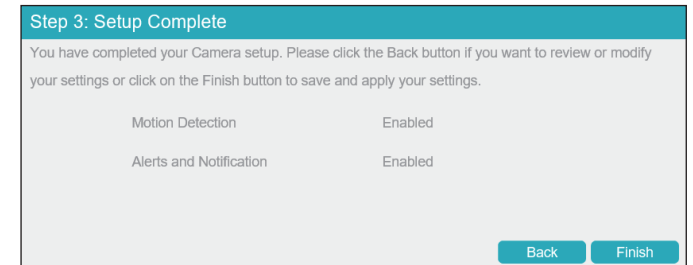

Settings

Network Settings

LAN Settings

Use this section to configure the network connections for your camera. All relevant information must be entered accurately. Please note that PPPoE must be disabled to make any changes on this page; refer to **"PPPoE" on page 34** for more details. After making any changes, click the **Save** button.

DHCP Select this if you have a DHCP server running on your network and would like your camera to obtain an IP address automatically. If you choose DHCP, you do not need to fill out the IP address settings.

IP Address Enter a static IP address in this field.

Subnet Mask This number is used to determine if the destination is in the same subnet. The default is **255.255.255.0**.

Default Gateway Enter the gateway used to forward frames to destinations in a different subnet.

The screenshot shows the LAN settings page for a D-Link camera. The interface includes a sidebar with navigation options: Live Video, Setup Wizard, Settings, Network Settings (highlighted), Camera Settings, Recording Management, Advanced Setup, and Camera Options. The main content area is titled 'LAN settings' and contains the following settings:

- DHCP:** A toggle switch is currently turned on. To the right, the IP address '192.168.8.111' is displayed.
- DHCP IP:** A text input field containing '192.168.8.1'.
- Default Router:** A text input field.
- Primary DNS:** A text input field.
- MTU (1280-1500):** A text input field containing '1500'.

At the bottom right of the settings area, there are two buttons: 'Refresh' and 'Save'.

PPPoE

Use this section to configure your camera's PPPoE settings. After making any changes, click the **Save** button to save your changes.

PPPoE Enable this setting if your network uses PPPoE.

User Name / Password Enter the username and password for your PPPoE account. Re-enter your password in the **Confirm Password** field. You may obtain this information from your ISP.

IP Address This shows your current IP address.

The screenshot shows the D-Link camera's web interface. The top right corner displays the D-Link logo and the model number DCS-412E v1.00. The page title is 'Live Video' and 'PPPoE'. On the left, there is a sidebar menu with the following items: Setup Wizard, Settings, Network Settings, LAN settings, PPPoE (highlighted in blue), HTTP/HTTPS, Device Port, RTSP and Multicast, and Camera Settings. The main content area is titled 'PPPoE' and contains a toggle switch for 'PPPoE' which is currently turned on. Below the toggle are four input fields: 'User Name', 'Password', 'Confirm Password', and 'IP Address'. The 'IP Address' field is labeled 'Empty'. At the bottom right of the form, there are two buttons: 'Refresh' and 'Save'.

HTTP and HTTPS

Use this section to configure the HTTP and HTTPS access settings for your camera. After making any changes, click the **Save** button to save your changes.

Web Mode Choose whether to use HTTP or HTTPS to access your camera.

HTTP Port Select the port to use to access your camera via HTTP. The default is **80**.

Certificate Information Displays information on your camera's HTTPS certificate. The camera's default HTTPS port is **443**.

The screenshot shows the configuration page for a D-Link camera (model DCS-4712E, v1.00). The page is titled "HTTP/HTTPS" and is divided into two main sections: "Web Mode" and "Certificate Information".

Web Mode: This section contains two settings:

- Web Mode:** A dropdown menu currently set to "HTTP". A "Save" button is located to the right of the dropdown.
- HTTP Port:** A text input field containing the number "80". A "Save" button is located to the right of the input field.

Certificate Information: This section displays the following details:

- Status:** Disabled
- Country:** TW
- State Or Province:** Taiwan
- Locality:** Taipei
- Organization:** D-Link Taiwan
- Organization Unit:** R&D Dept
- Common Name:** www.dlink.com.tw

At the bottom right of the "Certificate Information" section, there is a "Refresh" button.

The left sidebar of the interface includes the following menu items: Live Video, Setup Wizard, Settings (selected), Network Settings, LAN settings, PPPoE, HTTP/HTTPS (highlighted), Device Port, RTSP and Multicast, Camera Settings, Recording Management, Advanced Setup, and Camera Options.

Device Port

On this page you can set the ports on which users can access the camera's features.

Control Port Set the camera's control port to be used by a connected NVR. The default is **30001**.

HTTP Port Set the camera's HTTP port. The default is **80**.

RTSP Port Set the camera's RTSP port. The default is **554**.



RTSP and Multicast

Use this section to configure your camera's RTSP and multicast stream settings. After making any changes, click the **Save** button to save your changes.

RTSP

RTSP Port: Set the port to use for RTSP streaming. The default is **554**.

RTSP Rule This indicates the format of the RTSP path.

RTSP Example This provides an example of an RTSP path.

The screenshot shows the 'RTSP and Multicast' configuration page in the D-Link camera web interface. The 'RTSP' tab is selected. The settings include:

- RTSP Port:** 554
- RTSP Rule:** rtsp://ip/livestreamid.sdp
- RTSP Example:** rtsp://192.168.8.11/liv1.sdp

 There are 'Refresh' and 'Save' buttons at the bottom right of the settings area.

The camera allows you to multicast each of the available streams via a group address. Enter the port and settings you wish to use.

Multicast

Stream ID Select an ID for the stream.

Video Port Select the port to multicast the stream over.

Video Address Enter an address for the multicast stream.

The screenshot shows the 'RTSP and Multicast' configuration page in the D-Link camera web interface. The 'Multicast' tab is selected. The settings include:

- Stream ID:** 1
- Video Port:** 25330
- Video Address:** 238.255.255.255

 There are 'Refresh' and 'Save' buttons at the bottom right of the settings area.

Camera Settings

Use this section to configure the name used to identify your camera. After making any changes, click the **Save** button.

Camera Name Create a unique name for your camera.



Image Settings

In this section, you may configure the video image settings for your camera. All changes in the Image Settings section will be made immediately. For the other sections, after making any changes, click the **Save** button to save your changes.

Day/Night Switch The image settings in the tabs below will change according to whether it is day or night. Select **Timing** to schedule this manually.

Image

Brightness Adjust the brightness from 0% to 100%.

Sharpness Adjust the image sharpness level from 0% to 100%.

Saturation Adjust the image saturation level from 0% to 100%.

Contrast Adjust the contrast level from 0% to 100%.

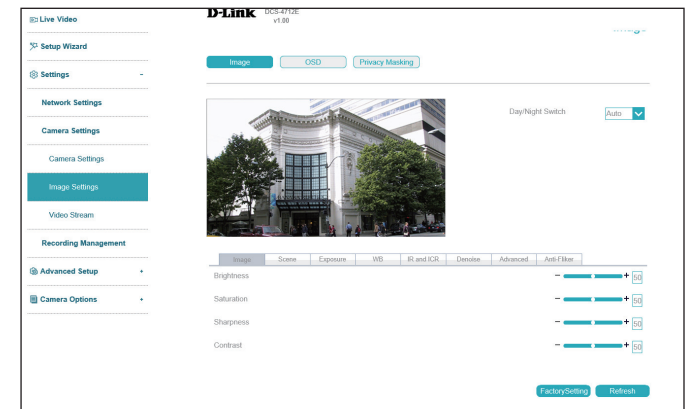

Scene

Scene Select either **Indoor** or **Outdoor**.

Mirror Mirror the image horizontally, vertically, or both.

Corridor Mode Toggle this to narrow the view and prioritize the center of the display. This optimizes the display for narrow environments, such as corridors and aisles.

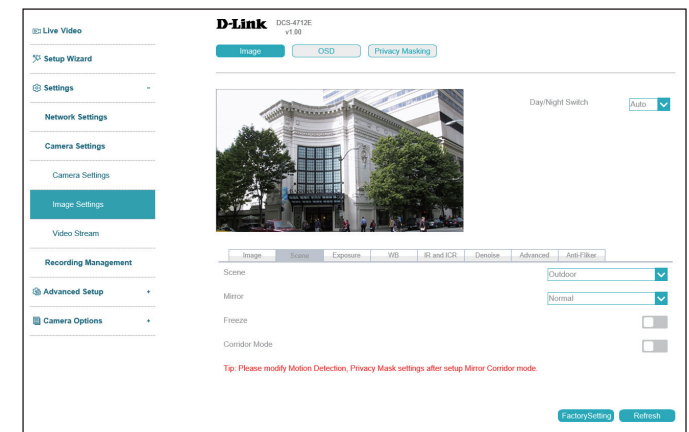

Exposure

Exposure Mode Choose an appropriate mode to limit exposure from backlit subjects. Select **Shutter Priority** to set the exposure time automatically and then adjust the video gain. Select **Manual** to set the shutter speed manually with the settings below.

Meter Area Select the area of the frame to use to determine the exposure.

Max Shutter Select the maximum shutter speed (in seconds) to use. Shorter shutter speeds provide a sharper picture, but require more light.

Max Gain Set the maximum camera gain. A higher gain amplifies the value of each pixel of the display.

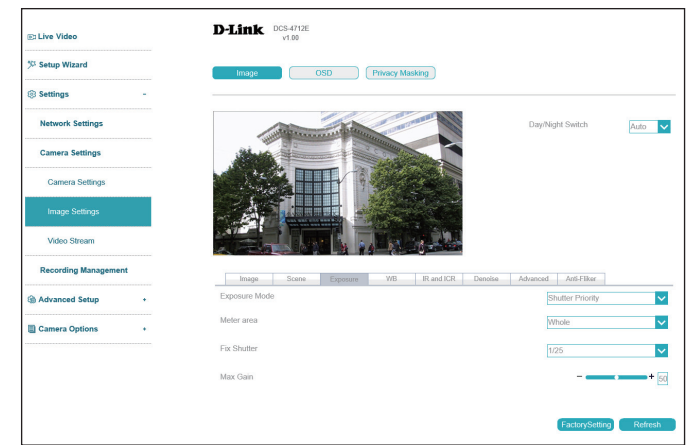

WB

WB Select the White Balance mode from a variety of options. If you select **Manual**, you will need to set the red and blue levels yourself.

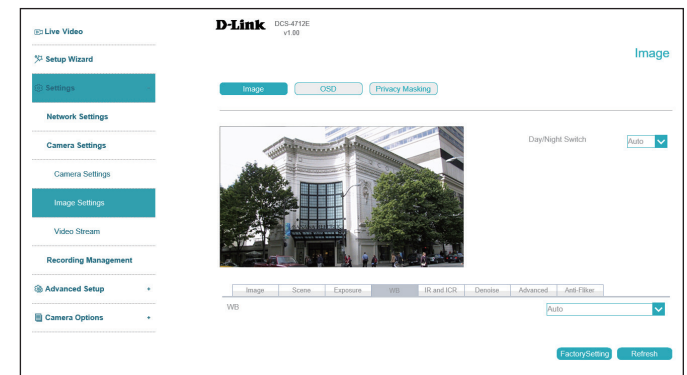

ICR & IR

Use this section to configure the IR LED and IR-cut removable filter behavior for your camera.

D/N Setting **Day Mode** enables the IR Cut Filter and turns off the IR LEDs. **Night Mode** disables the IR Cut Filter and turns on the IR LEDs. Select **Auto** to set the day/night mode automatically according to the amount of light in the environment, or **Timing** to set it according to a schedule.

Delay/Sensitivity If **Auto** is selected, configure how long the camera should wait after a change in lighting conditions to adjust the day/night mode, and how sensitive it should be to changes in the environment.

IR LED Toggle this to enable or disable the IR LED.

IR LED Mode Select **Manual** to set the IR LED level or **Auto** to have the camera adjust it automatically.

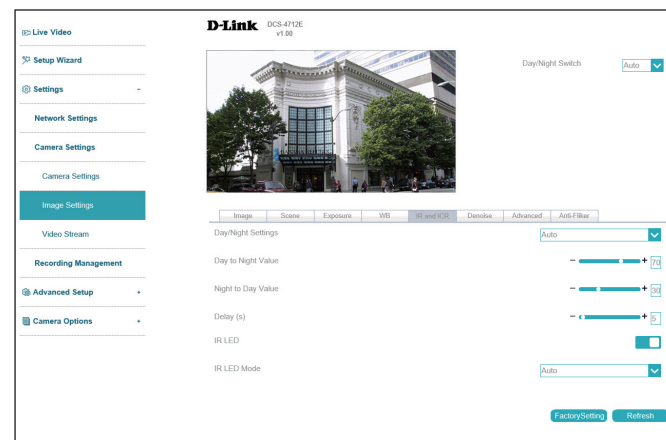

Denoise

- 2D/3D Denoise** Toggle this to enable 2D/3D noise reduction for the image.
- 2D/3D Denoise Mode** Choose whether to configure the denoise settings automatically or manually.
- 2D/3D Denoise Level** Configure the amount of noise reduction to apply. When noise reduction is enabled in a low-light environment with quickly moving objects, an afterimage trail may appear. To compensate for this, select a lower strength level or disable this function.

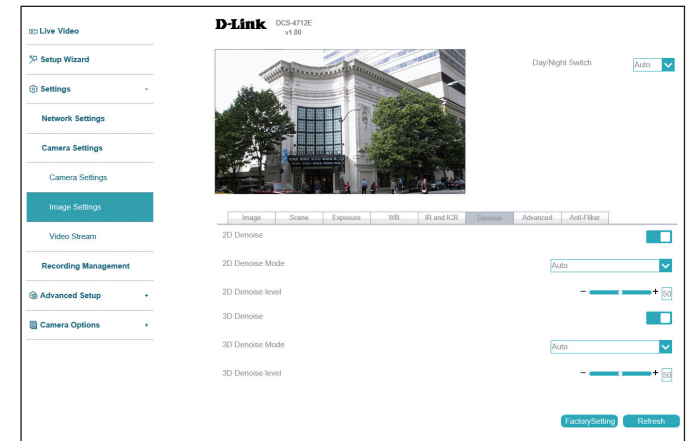

Advanced

WDR Wide Dynamic Range (WDR) helps improve exposure, making it easy to see objects in very bright or dark areas. Specify a value to determine how much WDR to apply, or select **None**.

HLC Adjust for overexposure with highlight compensation (HLC). This will detect strong light sources and compensate by reducing the brightness of overexposed areas.

BLC Adjust the overall lighting of the image with backlight compensation (BLC). This will add a weighted region in the center of the display and automatically adjust the exposure level.

DeFog Defog the image to improve the display quality in environments with poor weather conditions, such as fog or smoke.

Anti-shake Enable this to compensate for minor shaking of the camera, making the display smoother.

Anti-Flicker

Anti-Flicker Select the frequency to use to avoid interference or distortion.

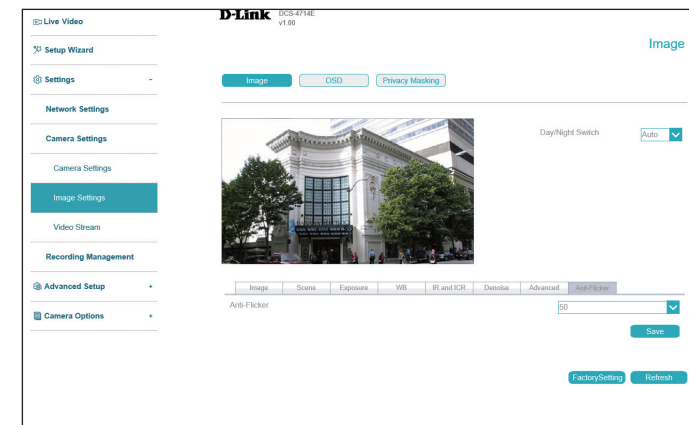
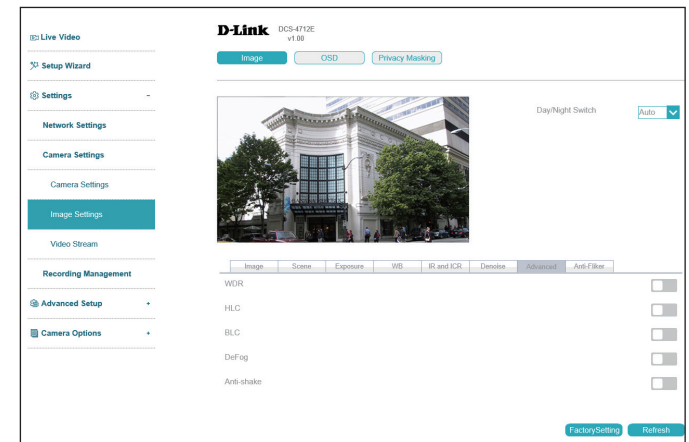

OSD

On this page you can configure the on-screen display (OSD) by using the drop-down menus to change the alignment and choosing what information to display.

Camera Time Display the camera time on the OSD.

Camera Name Display the camera name on the OSD.



Privacy Masking

On this page you can draw a privacy mask on the screen. This area of the camera's display will not be visible in the live video or video playback and cannot be recorded. In the list at the bottom, you can select an existing mask and either **Delete** or **Modify** it.

To create a new privacy mask, select an area of the live video display and click **Add**.

To change the name or color of the privacy mask, click the checkbox next to it under **Privacy Masking List** at the bottom of the screen and click **Modify**.

To clear the mask area, click the checkbox next to the desired privacy mask and click **Delete**. The name and color of the mask area is changeable.

The screenshot shows the D-Link camera web interface for a DCS-4714E v1.00 camera. The page is titled "Privacy Masking" and features a navigation menu on the left with options like Live Video, Setup Wizard, Settings, Network Settings, Camera Settings, Image Settings, Video Stream, Recording Management, Advanced Setup, and Camera Options. The main content area includes a live video feed with a black privacy mask, a "Privacy Masking List" table, and buttons for "Delete" and "Modify".

ID	Name	Type	Color	Enabled
1	Privacy Mask 1	Color Block	Black	Yes
2	Privacy Mask 2	Color Block	Blue	Yes

Video Stream

You may configure up to 2 video profiles with different settings for your camera. This allows you to set different settings for recording video and for viewing your video remotely, for example. After making any changes, click the **Save** button to save your changes.

Stream ID Select the stream ID to configure.

Video Encoding Type Select the video encoding type (**H265**, **H264**, or **MJPEG**).

Frame Size Select the frame size and aspect ratio.

Max. Frame Rate Set the max. frame rate.

Intra Frame Period Select the interval (in frames) at which the camera should record a complete image frame. A shorter interval is more resource-intensive than a longer one.

Rate Control Select the bitrate type (i.e. **CBR** or **VBR**).

- **VBR**: Variable Bit Rate will automatically change the bit rate based on the camera video's complexity. If the Mode is set to MJPEG, this will be the only choice available
- **CBR**: Constant Bit Rate will use a fixed bit rate that you set.

Bit Rate Enter the bitrate in kbps.

The screenshot shows the 'Video Stream' configuration page for a D-Link DCS-4712E v1.00 camera. The interface includes a sidebar with navigation options: Live Video, Setup Wizard, Settings (selected), Network Settings, Camera Settings, Camera Settings, Image Settings, Video Stream (highlighted), Recording Management, Advanced Setup, and Camera Options. The main content area is titled 'Stream' and contains the following settings:

- Stream ID: 1
- Video Encoding Type: H264
- Frame size: 1920x1080(16:9)
- Maximum Frame Rate: 25
- Intra Frame Period: 50
- Rate Control: CBR
- Bit Rate (Kbps) (500-12000): 4096

At the bottom right of the settings area, there are 'Refresh' and 'Save' buttons.

Recording Management

Your camera has a comprehensive event system that lets you configure the camera to perform certain actions when an event occurs. For example, when motion is detected, you can have snapshots sent to an e-mail address. You can also configure the camera to take regular video recordings according to a schedule you define.

Event Management / E-mail

- Server Address** Enter the address of the email server.
- Server Port** Enter the port to use to connect to the email server.
- User Name** Enter the username associated with the email account.
- Password** Enter the password associated with the above username.
- Sender E-mail Address** Enter the email address that the email should be sent from.
- Recipient E-mail Address** Enter the recipients to send the snapshot to.
- SSL/TLS** Select the protocol to use to secure your email.

The screenshot shows the D-Link camera web interface. The top navigation bar includes 'Live Video', 'Setup Wizard', and 'Settings'. The 'Settings' menu is expanded to show 'Recording Management', which is selected. Under 'Recording Management', there are tabs for 'Event MGMT', 'Motion Alarm', 'E-mail', 'FTP', and 'SD Card'. The 'E-mail' tab is active, displaying configuration fields for:

- Server IP Address
- Server Port (set to 25)
- User Name
- Password
- Sender E-mail Address
- Recipient E-mail Address
- SSL/TLS (set to No Encryption)

 An 'Email Test' button is located at the bottom right of the configuration area.

Event Management / FTP

FTP Upload Check this to upload recordings via FTP.

Server IP Address Enter the IP address of the FTP server you want to use.

Port Enter the port to use to connect to the server.

User Name Enter the username for the FTP server.

Password Enter the password associated with the username above.

FTP Path Enter the path to the directory where you would like your snapshots to be stored.

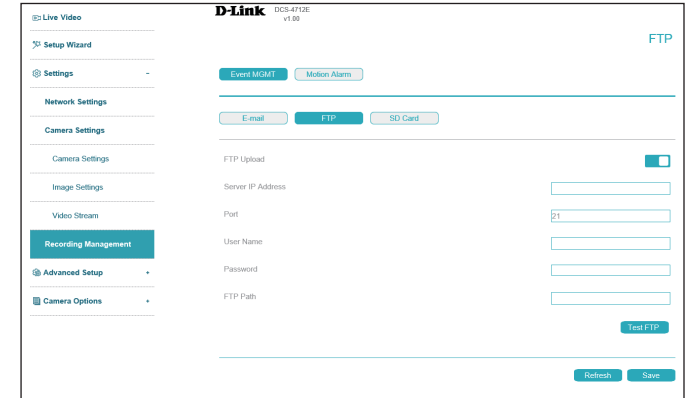

Event Management / SD Card

On this page you can configure your camera to record video to an inserted microSD card. Click **Format** to format the SD card (note that this will overwrite all current data on the card). Click **Schedule Record** to only save footage at set times. Click the blue square at the bottom of the screen and then click the schedule to indicate when you would like recordings to be stored. Click **Save** to save your recordings from the microSD card.

Schedule Record Toggle this to enable scheduled recording.

Post-Event Record This setting allows you to set the length of time to delay before taking a post-event snapshot. You can enter a value between 1 and 86400 seconds.

Record Rule Indicate whether the camera should continuously record and overwrite old data (**Cycle Store**) or save video for a set number of days (**Save Days**). If this option is selected, enter the number of days in the field below.

Stream Name Select the stream to record.

Scheduled Motion Detection Click the schedule at the bottom to specify a schedule to enable motion detection.

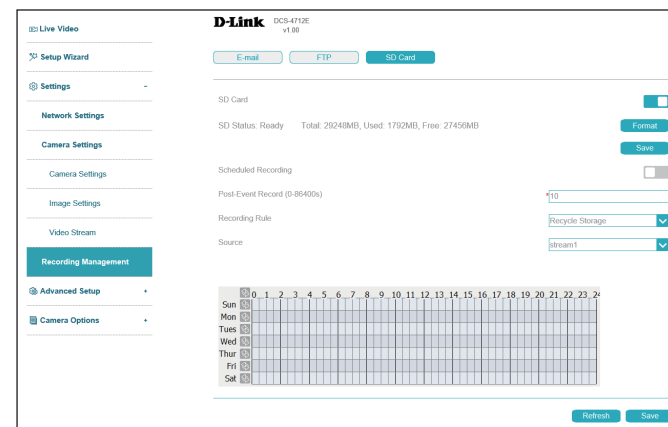

Motion Alarm

On this page you can configure an alarm to trigger when motion is detected in the camera's display. Click and drag on the screen to determine the area to monitor for motion.

Enable Click this to activate the motion detection alarm.

Alarm Interval Set the alarm interval in seconds.

Sensitivity Set the motion detection sensitivity. A higher number indicates greater sensitivity.

SD Card/Email/FTP Toggle these to send a snapshot via email or FTP or record video on the inserted microSD card. Click the blue square at the bottom of the screen for schedule setting.

Show motion detection on NVR Toggle this to display motion detection alarms on the connected NVR.

Click the blue square on the bottom of the screen to schedule the motion alarm.

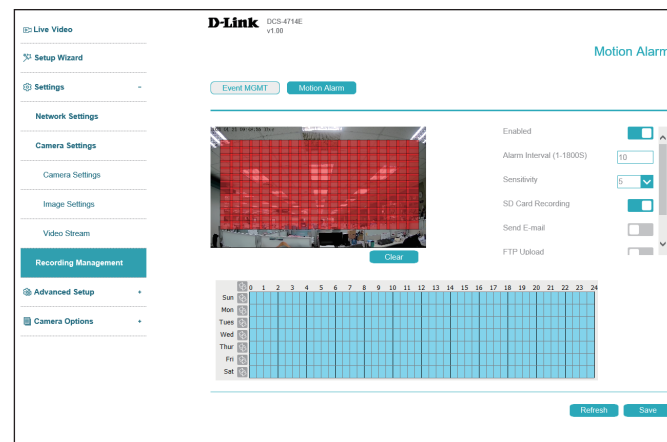

Advanced Setup

Advanced Port mapping

On this page you can enable or disable the port mapping feature.

Port Mapping Toggle this to enable or disable port mapping. If you enable this, you will also have to select a mode (Manual or Auto) and HTTP, RTSP and Control ports.

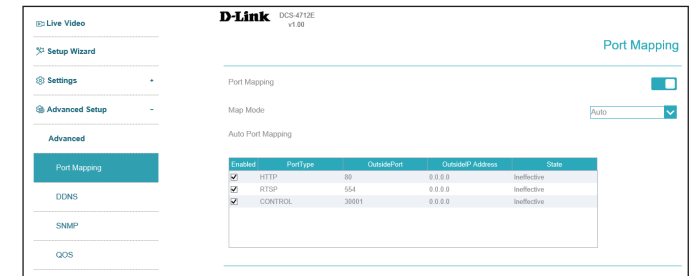

Port Mapping

Map Mode: Auto

Auto Port Mapping

Enabled	PortType	OutsidePort	OutsideIP Address	State
<input checked="" type="checkbox"/>	HTTP	80	0.0.0.0	Reflective
<input checked="" type="checkbox"/>	RTSP	554	0.0.0.0	Reflective
<input checked="" type="checkbox"/>	CONTROL	3001	0.0.0.0	Reflective

DDNS

DDNS allows you to compensate for changing IP addresses by having a URL that automatically points to the current IP address of the camera. To do this, you will need to have an account with one of the DDNS services listed in the drop-down box on this page. After making any changes, click the **Save** button.

DDNS Click here to enable DDNS.

Server Address Select your DDNS server from the drop-down menu.

Host Name Enter the host name of the DDNS service.

User Name Enter the username or email address used to connect to the DDNS server.

Password Enter the password used to connect to the DDNS service.

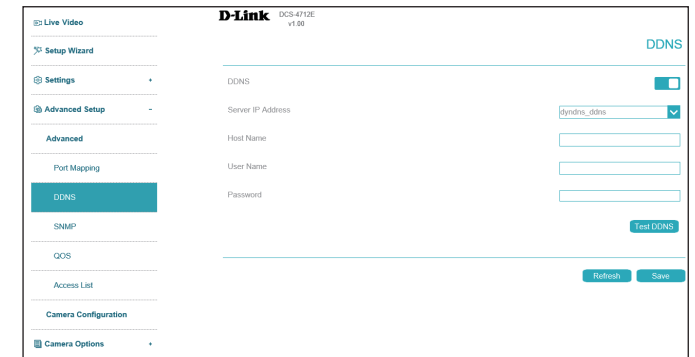

The screenshot shows the DDNS configuration interface for a D-Link camera. The page title is "D-Link DCS-4712E v1.00". The left sidebar contains a navigation menu with the following items: Live Video, Setup Wizard, Settings (selected), Advanced Setup, Advanced, Port Mapping, DDNS (highlighted), SNMP, QOS, Access List, Camera Configuration, and Camera Options. The main content area is titled "DDNS" and features a toggle switch for "DDNS" which is currently turned on. Below the toggle are three input fields: "Server IP Address" (with a dropdown menu showing "dyndns.com"), "Host Name", "User Name", and "Password". A "Test DDNS" button is located below the "Password" field. At the bottom right of the configuration area, there are "Refresh" and "Save" buttons.

SNMP

Here you can set the Simple Network Management Protocol (SNMP) settings for the camera. After making any changes, click the **Save** button.

Enable SNMPv1/v2c Enable this option to allow for SNMPv1 and SNMPv2c management of the camera.

Read/Write Community Enter a name for the R/W community of your SNMP server.

Read-Only Community Enter a name for the read-only community of your SNMP server.

Trap Address Enter the IP address where SNMP traps should be sent.

Trap Port Enter port of the IP address to which the trap messages will be sent.

Trap Community Enter the SNMP trap community name.

The screenshot shows the configuration page for a D-Link camera (model DCS-4702E v1.00). The left sidebar contains a navigation menu with options: Live Video, Setup Wizard, Settings, Advanced Setup, Advanced, Port Mapping, DDNS, SNMP (highlighted in teal), QoS, Access List, Camera Configuration, and Camera Options. The main content area is titled 'SNMP' and includes the following settings:

- Enable SNMPv3: A toggle switch that is currently turned on.
- Read Only Security Name: A text input field.
- Security Level: A dropdown menu set to 'AuthNoPriv'.
- Authentication Type: A dropdown menu set to 'SHA'.
- Authentication Password: A text input field.
- Encryption Algorithm: A dropdown menu set to 'AES'.
- Encryption Password: A text input field.
- Write Security Name: A text input field.
- Security Level: A dropdown menu set to 'AuthPriv'.
- Authentication Type: A dropdown menu set to 'SHA'.
- Authentication Password: A text input field.

Enable SNMPv3 Click this to enable SNMPv3.

Read Only Security Name Enter a name for the R/O community of your SNMP server.

Security Level Select the security level used by your SNMP server.

Authentication Type Select the type of hash (**MD5** or **SHA**) to use.

Authentication Password Enter the authentication password used for your R/O SNMP server.

Encryption Algorithm Select the encryption algorithm used by your R/O SNMP server.

Encryption Password Select the password used for your R/O SNMP server.

Write Security Name Enter the name for the R/W community of your SNMP server.

Security Level Select the security level used by your R/W SNMP server.

The screenshot shows the D-Link web interface for the DCS-4712E v1.00 camera. The left sidebar contains a navigation menu with the following items: Live Video, Setup Wizard, Settings, Advanced Setup, Port Mapping, DDNS, QoS, Access List, Camera Configuration, and Camera Options. The 'SNMP' option is highlighted in blue. The main content area displays the SNMP configuration page. At the top right, there is a toggle switch for 'Enable SNMPv3' which is currently turned on. Below this, there are several configuration fields: 'Read Only Security Name' (text input), 'Security Level' (dropdown menu set to 'AuthPriv'), 'Authentication Type' (dropdown menu set to 'SHA256'), 'Authentication Password' (text input), 'Encryption Algorithm' (dropdown menu set to 'AES256'), 'Encryption Password' (text input), 'Write Security Name' (text input), 'Security Level' (dropdown menu set to 'AuthPriv'), 'Authentication Type' (dropdown menu set to 'SHA256'), 'Authentication Password' (text input), 'Encryption Algorithm' (dropdown menu set to 'AES256'), and 'Encryption Password' (text input).

Section 3: Configuration

- Authentication Type** Select the type of hash (**MD5** or **SHA**) to use.
- Authentication Password** Enter the authentication password used for your R/W SNMP server.
- Encryption Algorithm** Select the encryption algorithm used by your R/W SNMP server.
- Encryption Password** Select the password used for your R/W SNMP server.
- SNMP Port** Enter the SNMP port to use. The default is **161**.

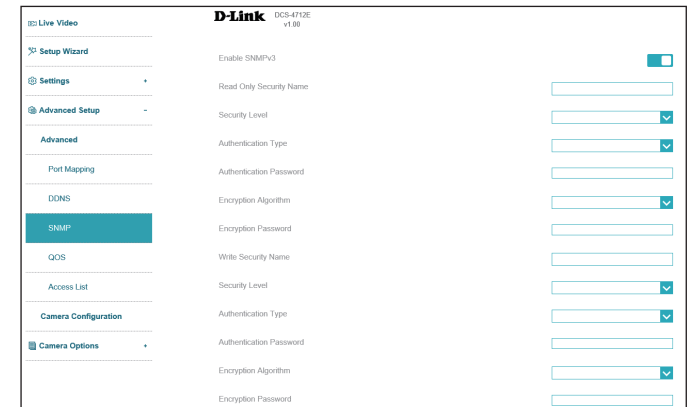

D-Link DCS-4712E v1.00

Live Video

Setup Wizard

Settings

Advanced Setup

Advanced

Port Mapping

DDNS

SNMP

QoS

Access List

Camera Configuration

Camera Options

Enable SNMPv3

Read Only Security Name

Security Level

Authentication Type

Authentication Password

Encryption Algorithm

Encryption Password

Write Security Name

Security Level

Authentication Type

Authentication Password

Encryption Algorithm

Encryption Password

QoS

Class of Service (CoS) and Quality of Service (QoS) allow you to prioritize surveillance traffic on your network to ensure that your cameras can stream video smoothly and remain accessible even when there is heavy traffic on your network. Your network must support CoS or QoS in order to use them. After making changes, click the **Save** button.

Live Video Set the priority level for live video.

Event Alarm Set the priority level for event alarms.

Command DSCP Set the priority level for command DSCP.

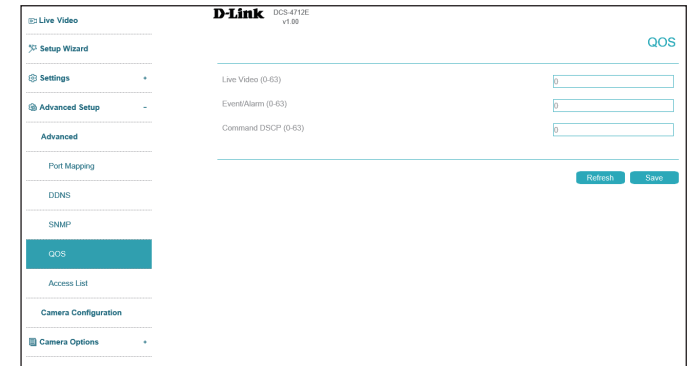

The screenshot shows the D-Link web interface for QoS configuration. The page title is "QoS" and the device model is "D-Link DCS-4112E v1.00". The left sidebar contains a navigation menu with the following items: Live Video, Setup Wizard, Settings, Advanced Setup, Advanced, Port Mapping, DDNS, SNMP, QoS (highlighted), Access List, Camera Configuration, and Camera Options. The main content area displays three configuration fields: "Live Video (0-63)" with a value of 0, "Event/Alarm (0-63)" with a value of 0, and "Command DSCP (0-63)" with a value of 0. At the bottom right of the main content area, there are "Refresh" and "Save" buttons.

Access List

Here you can define which IP addresses are allowed to access your camera.

IP Filter Click this to enable or disable the IP filter.

Rule Type Select the type of rule to implement, **Allow** or **Deny**. Depending on the rule, the IPs you enter will either be allowed through (meaning others will be blocked), or they will be blocked (meaning that by default, others will be allowed through). Click the plus (+) icon to add a new IP range to apply the rule to.

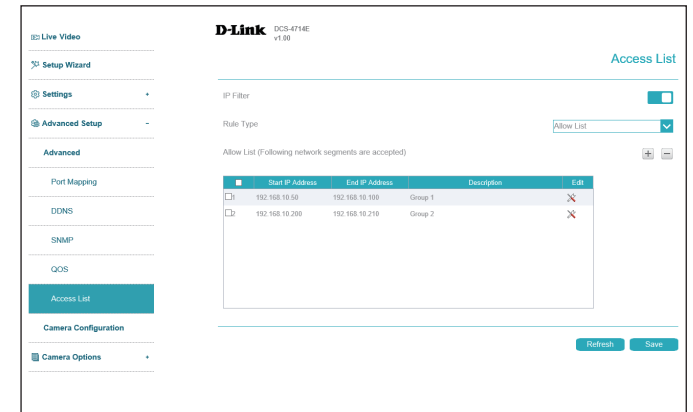

Camera Configuration Factory Reset

Here you can reset the camera configuration back to the factory defaults.

Keep Network Setting Click this to preserve your current network settings when you restore your camera to factory default settings.

Restore to Factory Default Click this to restore your camera to factory default settings.

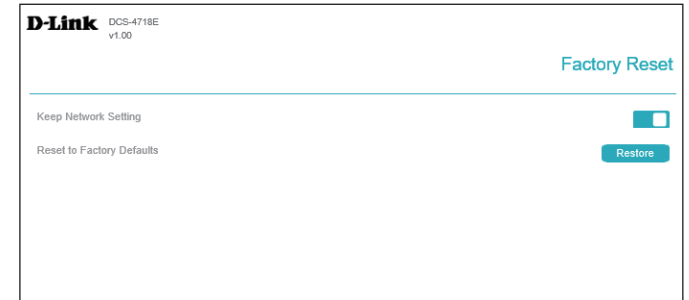

Reboot Device

Here you can reboot the camera, or set a schedule to reboot the camera automatically.

Reboot Device This will restart your camera.

Schedule Reboot If you want your camera to reboot on a regular schedule, enable this option, then select the days of the week and the time that you want the camera to reboot and click the **Save** button.

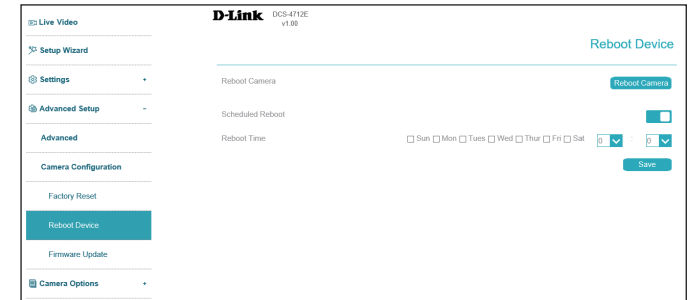

Firmware Update

Here you can check and update the camera's firmware.

Current/Latest Version Click this to check for the latest firmware version online.

Update Now Click this to perform a firmware upgrade immediately.

Auto Check Latest Version Toggle this to automatically check for new firmware versions at the time you specify with the drop-down menu below.

Auto Update Toggle this to automatically update to a new version when the auto check is performed.

Below, you can schedule the automatic check/update with the drop-down menus. Enter the time of day (in hours/minutes, from left to right) and the day of the week to perform the check.

File Path To upgrade from a firmware file, click the folder icon, navigate to the file on your hard drive, and click **Upload**.

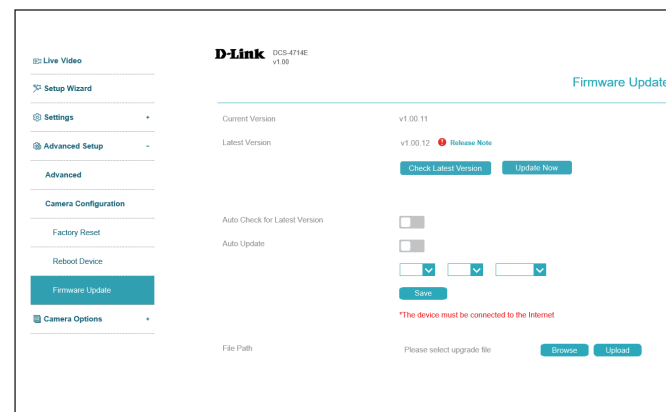

Camera Options

Camera Info

This page displays detailed information about your camera, the services running on your camera, and active video streams.

D-Link DCS-4714E
v1.00

Camera Info

IP Address	192.168.10.119
PPPOE Address	
Camera Name	DCS-4714E
Firmware Version	v1.00.12
MAC Address	00:1C:27:15:4B:2E
Hardware Version	A

Time & Date

Time & Date	Thu Jan 21 2021 10:04:12 GMT
-------------	------------------------------

Service Status

Service	Enabled/Disabled
Port Mapping	Disabled
DDNS	Disabled
Access List	Enabled

[Refresh](#)

Date and Time Time Settings

This section allows you set the time zone and Daylight Saving settings for your camera.

Time Zone Select your time zone from the drop-down menu.

Daylight Savings Time If your region uses Daylight Saving time, you can enable it here. Select Set date and time manually if you want to manually set the offset and the period of time that the Daylight Saving correction should be used.

Start Time: If you enabled the previous option, set the date and time that Daylight Saving should start.

End Time: Set the date and time that Daylight Saving should end.

Current PC Time Click **Save** to synchronize the camera according to your current PC time.

Set Manually Enter a time and click **Save** to set it manually.

NTP Server Enable this option to set your camera's time using an NTP server, then select an NTP server to use from the drop-down box.

NTP Port Enter the port to use to access the NTP server.

Check time interval Enter an interval (in seconds) at which to check the camera's time against the NTP server.

Administration Settings

Admin Password

Here, you may modify the administrator's password for your camera. Click **Add** to add a new user, or click the pencil icon under **Operate** to edit an existing user's information.

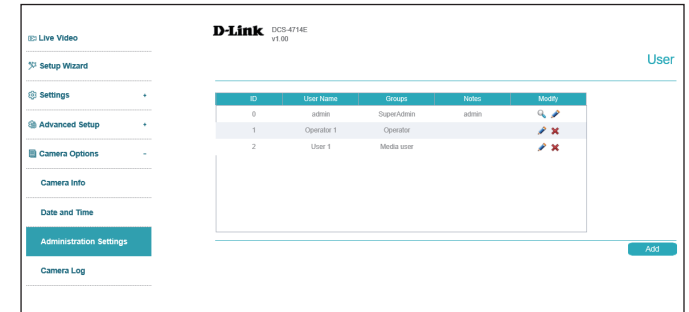

Admin / Add or Edit User

Here, you may add user accounts for accessing the camera. User accounts are allowed to access the Live Video page, but cannot access any of the camera's configuration pages.

User Name Enter a user name for the user you wish to create.

New/Confirm Password Enter a password for the user you wish to create. Retype the password to confirm it.

Group Designate the new user's group. This will affect the user privileges they have. This will affect the options that appear in the **Privilege** menu.

Privilege Click the boxes in this menu to determine that level of access the specified user should have to the camera's video display and configuration options.

Notes Enter any notes you would like to record here.

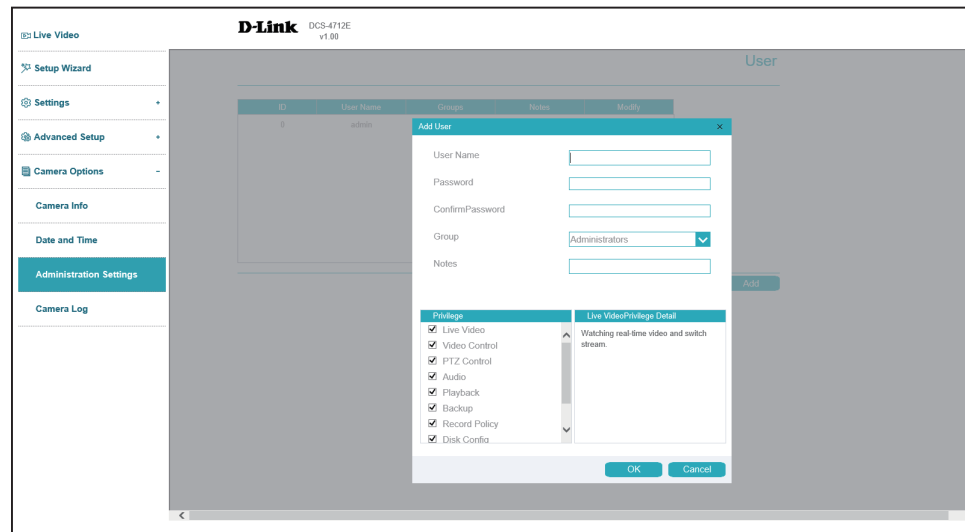

Camera Log

This page displays a log of events, such as motion detection alarms. You may download the information by clicking **Download**. You may also click **Query** to search for an event.

Operation Log

Start Time

End Time

Device

2020-12-16 16:25:05

2020-12-17 16:27:05

Download
Query

Reboot Time	User Name	Log Info
2020-12-17 16:27:04	admin	Stop IntelligenceAnalyse Stream
2020-12-17 16:27:00	admin	Configure motion detection linkage
2020-12-17 16:26:50	admin	Start IntelligenceAnalyse Stream
2020-12-17 16:26:43	admin	Configure AV stream parameter
2020-12-17 16:26:31	admin	Stop IntelligenceAnalyse Stream
2020-12-17 16:26:31	admin	Start IntelligenceAnalyse Stream
2020-12-17 16:26:25	admin	Configure device name
2020-12-17 16:24:43	admin	Collect Alarm Log
2020-12-17 16:23:15	admin	Stop IntelligenceAnalyse Stream
2020-12-17 16:23:04	admin	Start IntelligenceAnalyse Stream

K <

> >

Camera Log / Alarm

An alarm log records information about an alarm generated on a device, including the **Security, Disk, and Recording alarms**. Choose the **Alarm Type** from the drop box, setup **Start Time** and **End Time**, and then click **Query**. The all alarm log will be displayed on the web, click **Download** to save the logs to your PC.

Alarm Type ▼

Start Time

End Time

Alarm Begin Time	Alarm End Time	Log Info	Source ID
2020-12-17 16:22:58	2020-12-17 16:27:12	Motion Detect Alarm	1

K < ▼ > >|

Section 3: Configuration

Operation logs record user operations and scheduled task commands during the running of the device. Operation logs can be classified into the following types: **Privilege Manager, System maintenance, Device, Recording operation, Video control, and Live video.**

Choose the **Operation logs Type** from the drop box, setup **Start Time** and **End Time**, and then click **Query**.

The all alarm log will be displayed on the web, click **Download** to save the logs to your PC.

Operation Log Device

Start Time

End Time

Reboot Time	User Name	Log Info
2020-12-17 16:27:04	admin	Stop IntelligenceAnalyse Stream
2020-12-17 16:27:00	admin	Configure motion detection linkage
2020-12-17 16:26:50	admin	Start IntelligenceAnalyse Stream
2020-12-17 16:26:43	admin	Configure AV stream parameter
2020-12-17 16:26:31	admin	Stop IntelligenceAnalyse Stream
2020-12-17 16:26:31	admin	Start IntelligenceAnalyse Stream
2020-12-17 16:26:25	admin	Configure device name
2020-12-17 16:24:43	admin	Collect Alarm Log
2020-12-17 16:23:15	admin	Stop IntelligenceAnalyse Stream
2020-12-17 16:23:04	admin	Start IntelligenceAnalyse Stream

Section 3: Configuration

You can collect logs about a device, which help you analyze and solve possible problems occurring on the device. The logs include overview information, key parameters, operation logs, alarm logs, upgrade logs. Click **Collect All Log** and save the logs to your PC.

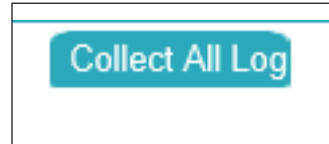

Technical Specifications - DCS-4712E

Technical Specifications		
Camera		
Camera Hardware Profile	<ul style="list-style-type: none"> • 1/2.8" 2-megapixel progressive CMOS sensor • 30 meter IR illumination distance • Minimum illumination: <ul style="list-style-type: none"> • Color: 0.05 lux @(F1.4, AGC ON) • B/W: 0 lux @(IR LED ON) • Built-in Infrared-Cut Removable (ICR) Filter module • 18x digital zoom • Minimum object distance 0.5 m 	<ul style="list-style-type: none"> • Focal length: 2.8 m • Aperture: F2.0 • Angle of view: <ul style="list-style-type: none"> • (H) 106.8° • (V) 58° • (D) 126°
Camera Housing	<ul style="list-style-type: none"> • IP66 compliant weatherproof housing 	<ul style="list-style-type: none"> • Wire-in bracket
Image Features	<ul style="list-style-type: none"> • Configurable image size/quality/frame rate/bit rate • Time stamp and text overlays • Configurable shutter speed/brightness/saturation/contrast/sharpness/3D filter • Configurable motion detection area • Configurable privacy mask zones 	<ul style="list-style-type: none"> • Auto White Balance (AWB) • Auto Gain Control (AGC) • Wide Dynamic Range (WDR) • Corridor mode
Video Compression	<ul style="list-style-type: none"> • Simultaneous H.265/H.264/MJPEG format compression 	<ul style="list-style-type: none"> • JPEG for still images
Video Resolution	<ul style="list-style-type: none"> • 1920 x 1080 at up to 30 fps 	
External Device Interface	<ul style="list-style-type: none"> • 10/100 BASE-TX Fast Ethernet port • microSD card slot 	<ul style="list-style-type: none"> • Supports 802.3af PoE • Reset button
Network		
Network Protocols	<ul style="list-style-type: none"> • IPv4 • HTTP/HTTPS • RTSP/RTP/RTCP • TCP • UDP • DHCP • DNS • DDNS • NTP 	<ul style="list-style-type: none"> • FTP • SMTP Client • ONVIF Profile S compliant • ARP • ICMP • PPPoE • SNMP v1/v2c/v3

Appendix A: Technical Specifications

System Management		
Event Management	<ul style="list-style-type: none"> • Motion detection • Multiple event notifications 	<ul style="list-style-type: none"> • Event notification and uploading of snapshots via e-mail or FTP • Event video recording via microSD card, D-ViewCam, D-Link NVR or ONVIF-compliant NAS
Remote Management	<ul style="list-style-type: none"> • Remote management via D-ViewCam software • Remotely take snapshots/video clips and save to a local hard drive 	<ul style="list-style-type: none"> • Configuration interface accessible via a web browser
System Requirements for Web Interface	<ul style="list-style-type: none"> • Operating System: Microsoft Windows • Browser: Internet Explorer 11 for full functionality, Chrome and Firefox (MJPEG only) 	
D-ViewCam™ System Requirements	<ul style="list-style-type: none"> • Operating System: Windows 10 • Browser: Internet Explorer 11 	<ul style="list-style-type: none"> • Protocol: Standard TCP/IP
D-ViewCam™ Software Functions	<ul style="list-style-type: none"> • Supports all management functions provided in the web interface • Scheduled motion trigger or manual recording options 	<ul style="list-style-type: none"> • Remote management of up to 64 cameras • Viewing of up to 64 cameras on one screen
General		
Weight	<ul style="list-style-type: none"> • 500 g (1.1 lb) 	
External Power Adapter	<ul style="list-style-type: none"> • 100 to 240 V AC, 50/60 Hz (Input), 12 V DC 1.5 A (Output) 	
Power Consumption	<ul style="list-style-type: none"> • 8 W ± 5% (PoE) 	
Temperature	<ul style="list-style-type: none"> • Operating: -30 to 50 °C (-22 to 122 °F) 	<ul style="list-style-type: none"> • Storage: -20 to 70° C (-4 to 158 °F)
Operating/Storage Humidity	<ul style="list-style-type: none"> • Max. 90% non-condensing 	
Certifications	<ul style="list-style-type: none"> • CE, FCC, RCM 	
Dimensions	<ul style="list-style-type: none"> • 187.6 x 64 x 64 mm (7.4 x 2.5 x 2.5 in) 	

Technical Specifications - DCS-4714E

Technical Specifications		
Camera		
Camera Hardware Profile	<ul style="list-style-type: none"> • 1/2.8" 4-megapixel progressive CMOS sensor • 30 meter IR illumination distance • Minimum illumination: <ul style="list-style-type: none"> • Color: 0.05 lux @(F2.0, AGC ON) • B/W: 0 lux @(IR LED ON) • Built-in Infrared-Cut Removable (ICR) Filter module • 18x digital zoom • Minimum object distance 0.5 m 	<ul style="list-style-type: none"> • Focal length: 2.8 m • Aperture: F2.0 • Angle of view: <ul style="list-style-type: none"> • (H) 100° • (V) 58° • (D) 126°
Camera Housing	<ul style="list-style-type: none"> • IP66 compliant weatherproof housing 	<ul style="list-style-type: none"> • Wire-in bracket
Image Features	<ul style="list-style-type: none"> • Configurable image size/quality/frame rate/bit rate • Time stamp and text overlays • Configurable shutter speed/brightness/saturation/contrast/sharpness/3D filter • Configurable motion detection area • Configurable privacy mask zones 	<ul style="list-style-type: none"> • Auto White Balance (AWB) • Auto Gain Control (AGC) • Wide Dynamic Range (WDR) • Corridor mode
Video Compression	<ul style="list-style-type: none"> • Simultaneous H.265/H.264/MJPEG format compression 	<ul style="list-style-type: none"> • JPEG for still images
Video Resolution	<ul style="list-style-type: none"> • 2592 x 1520 at up to 30 fps 	
External Device Interface	<ul style="list-style-type: none"> • 10/100 BASE-TX Fast Ethernet port • microSD card slot 	<ul style="list-style-type: none"> • Supports 802.3af PoE • Reset button
Network		
Network Protocols	<ul style="list-style-type: none"> • IPv4 • HTTP/HTTPS • RTSP/RTP/RTCP • TCPL • UDP • DHCP • DNS • DDNS • NTP 	<ul style="list-style-type: none"> • FTP • SMTP Client • ONVIF Profile S compliant • ARP • ICMP • PPPoE • SNMP v1/v2c/v3

Appendix A: Technical Specifications

System Management		
Event Management	<ul style="list-style-type: none"> • Motion detection • Multiple event notifications 	<ul style="list-style-type: none"> • Event notification and uploading of snapshots via e-mail or FTP • Event video recording via microSD card, D-ViewCam, D-Link NVR or ONVIF-compliant NAS
Remote Management	<ul style="list-style-type: none"> • Remote management via D-ViewCam software • Remotely take snapshots/video clips and save to a local hard drive 	<ul style="list-style-type: none"> • Configuration interface accessible via a web browser
System Requirements for Web Interface	<ul style="list-style-type: none"> • Operating System: Microsoft Windows • Browser: Internet Explorer 11 for full functionality, Chrome and Firefox (MJPEG only) 	
D-ViewCam™ System Requirements	<ul style="list-style-type: none"> • Operating System: Windows 10 • Browser: Internet Explorer 11 	<ul style="list-style-type: none"> • Protocol: Standard TCP/IP
D-ViewCam™ Software Functions	<ul style="list-style-type: none"> • Supports all management functions provided in the web interface • Scheduled motion trigger or manual recording options 	<ul style="list-style-type: none"> • Remote management of up to 64 cameras • Viewing of up to 64 cameras on one screen
General		
Weight	<ul style="list-style-type: none"> • 500 g (1.1 lb) 	
External Power Adapter	<ul style="list-style-type: none"> • 100 to 240 V AC, 50/60 Hz (Input), 12 V DC 1.5 A (Output) 	
Power Consumption	<ul style="list-style-type: none"> • 8 W ± 5% (PoE) 	
Temperature	<ul style="list-style-type: none"> • Operating: -30 to 50 °C (-22 to 122 °F) 	<ul style="list-style-type: none"> • Storage: -20 to 70° C (-4 to 158 °F)
Operating/Storage Humidity	<ul style="list-style-type: none"> • Max. 90% non-condensing 	
Certifications	<ul style="list-style-type: none"> • CE, FCC, RCM 	
Dimensions	<ul style="list-style-type: none"> • 187.6 x 64 x 64 mm (7.4 x 2.5 x 2.5 in) 	

Technical Specifications - DCS-4718E

Technical Specifications		
Camera		
Camera Hardware Profile	<ul style="list-style-type: none"> • 1/2.5" 8-megapixel progressive CMOS sensor • 30 meter IR illumination distance • Minimum illumination: <ul style="list-style-type: none"> • Color: 0.02 lux @(F1.4, AGC ON) • B/W: 0 lux @(IR LED ON) • Built-in Infrared-Cut Removable (ICR) Filter module • 18x digital zoom • Minimum object distance 0.5 m 	<ul style="list-style-type: none"> • Focal length: 3.3 - 12 m • Aperture: F1.4 • Angle of view: <ul style="list-style-type: none"> • (H) 108.6° - 35° • (V) 56° - 21° • (D) 125° - 42°
Camera Housing	<ul style="list-style-type: none"> • IP66 compliant weatherproof housing 	<ul style="list-style-type: none"> • Wire-in bracket
Image Features	<ul style="list-style-type: none"> • Configurable image size/quality/frame rate/bit rate • Time stamp and text overlays • Configurable shutter speed/brightness/saturation/contrast/sharpness/3D filter • Configurable motion detection area • Configurable privacy mask zones 	<ul style="list-style-type: none"> • Auto White Balance (AWB) • Auto Gain Control (AGC) • Wide Dynamic Range (WDR) • Corridor mode
Video Compression	<ul style="list-style-type: none"> • Simultaneous H.265/H.264/MJPEG format compression 	<ul style="list-style-type: none"> • JPEG for still images
Video Resolution	<ul style="list-style-type: none"> • 3840 x 2160 at up to 20 fps 	
External Device Interface	<ul style="list-style-type: none"> • 10/100 BASE-TX Fast Ethernet port • microSD card slot 	<ul style="list-style-type: none"> • Supports 802.3af PoE • Reset button
Network		
Network Protocols	<ul style="list-style-type: none"> • IPv4 • HTTP/HTTPS • RTSP/RTP/RTCP • TCP • UDP • DHCP • DNS • DDNS • NTP 	<ul style="list-style-type: none"> • FTP • SMTP • ONVIF Profile S compliant • ARP • ICMP • PPPoE • SNMP v1/v2c/v3

Appendix A: Technical Specifications

System Management		
Event Management	<ul style="list-style-type: none"> • Motion detection • Multiple event notifications 	<ul style="list-style-type: none"> • Event notification and uploading of snapshots via e-mail or FTP • Event video recording via microSD card, D-ViewCam, D-Link NVR or ONVIF-compliant NAS
Remote Management	<ul style="list-style-type: none"> • Remote management via D-ViewCam software • Remotely take snapshots/video clips and save to a local hard drive 	<ul style="list-style-type: none"> • Configuration interface accessible via a web browser
System Requirements for Web Interface	<ul style="list-style-type: none"> • Operating System: Microsoft Windows • Browser: Internet Explorer 11 for full functionality, Chrome and Firefox (MJPEG only) 	
D-ViewCam™ System Requirements	<ul style="list-style-type: none"> • Operating System: Windows 10 • Browser: Internet Explorer 11 	<ul style="list-style-type: none"> • Protocol: Standard TCP/IP
D-ViewCam™ Software Functions	<ul style="list-style-type: none"> • Supports all management functions provided in the web interface • Scheduled motion trigger or manual recording options 	<ul style="list-style-type: none"> • Remote management of up to 64 cameras • Viewing of up to 64 cameras on one screen
General		
Weight	<ul style="list-style-type: none"> • 700 g (1.5 lb) 	
External Power Adapter	<ul style="list-style-type: none"> • 100 to 240 V AC, 50/60 Hz (Input), 12 V DC 1.5 A (Output) 	
Power Consumption	<ul style="list-style-type: none"> • 8 W ± 5% (PoE) 	
Temperature	<ul style="list-style-type: none"> • Operating: -30 to 50 °C (-22 to 122 °F) 	<ul style="list-style-type: none"> • Storage: -20 to 70° C (-4 to 158 °F)
Operating/Storage Humidity	<ul style="list-style-type: none"> • Max. 90% non-condensing 	
Certifications	<ul style="list-style-type: none"> • CE, FCC, RCM 	
Dimensions	<ul style="list-style-type: none"> • 232 x 74 x 80 mm (9.1 x 2.9 x 3.1 in) 	

Regulatory Information

Federal Communication Commission Interference Statement

This equipment has been tested and found to comply with the limits for a Class A digital device, pursuant to part 15 of the FCC Rules. These limits are designed to provide reasonable protection against harmful interference when the equipment is operated in a commercial environment. This equipment generates, uses, and can radiate radio frequency energy and, if not installed and used in accordance with the instruction manual, may cause harmful interference to radio communications. Operation of this equipment in a residential area is likely to cause harmful interference in which case the user will be required to correct the interference at his own expense.

Non-modification Statement

Any changes or modifications not expressly approved by the party responsible for compliance could void the user's authority to operate the equipment.

Caution

This device complies with Part 15 of the FCC Rules. Operation is subject to the following two conditions:

(1) This device may not cause harmful interference, and (2) this device must accept any interference received, including interference that may cause undesired operation.

Innovation, Science and Economic Development Canada (ISED) Statement:

This Class A digital apparatus complies with Canadian ICES-003.

Cet appareil numérique de la classe A est conforme à la norme NMB-003 du Canada.

CE EMI Class A Warning

This equipment is compliant with Class A of CISPR 32. In a residential environment this equipment may cause radio interference.

SAFETY INSTRUCTIONS

The following general safety guidelines are provided to help ensure your own personal safety and protect your product from potential damage. Remember to consult the product user instructions for more details.

- Static electricity can be harmful to electronic components. Discharge static electricity from your body (i.e. touching grounded bare metal) before touching the product.
- Do not attempt to service the product and never disassemble the product. For some products with a user replaceable battery, please read and follow the instructions in the user manual.
- Do not spill food or liquid on your product and never push any objects into the openings of your product.
- Do not use this product near water, areas with high humidity, or condensation unless the product is specifically rated for outdoor application.
- Keep the product away from radiators and other heat sources.
- Always unplug the product from mains power before cleaning and use a dry lint free cloth only.

SICHERHEITSVORSCHRIFTEN

Die folgenden allgemeinen Sicherheitsvorschriften dienen als Hilfe zur Gewährleistung Ihrer eigenen Sicherheit und zum Schutz Ihres Produkts. Weitere Details finden Sie in den Benutzeranleitungen zum Produkt.

- Statische Elektrizität kann elektronischen Komponenten schaden. Um Schäden durch statische Aufladung zu vermeiden, leiten Sie elektrostatische Ladungen von Ihrem Körper ab, (z. B. durch Berühren eines geerdeten blanken Metallteils), bevor Sie das Produkt berühren.
- Unterlassen Sie jeden Versuch, das Produkt zu warten, und versuchen Sie nicht, es in seine Bestandteile zu zerlegen. Für einige Produkte mit austauschbaren Akkus lesen Sie bitte das Benutzerhandbuch und befolgen Sie die dort beschriebenen Anleitungen.
- Vermeiden Sie, dass Speisen oder Flüssigkeiten auf Ihr Produkt gelangen, und stecken Sie keine Gegenstände in die Gehäuseschlitze oder -öffnungen Ihres Produkts.
- Verwenden Sie dieses Produkt nicht in unmittelbarer Nähe von Wasser und nicht in Bereichen mit hoher Luftfeuchtigkeit oder Kondensation, es sei denn, es ist speziell zur Nutzung in Außenbereichen vorgesehen und eingestuft.
- Halten Sie das Produkt von Heizkörpern und anderen Quellen fern, die Wärme erzeugen.
- Trennen Sie das Produkt immer von der Stromzufuhr, bevor Sie es reinigen und verwenden Sie dazu ausschließlich ein trockenes fusselfreies Tuch.

CONSIGNES DE SÉCURITÉ

Les consignes générales de sécurité ci-après sont fournies afin d'assurer votre sécurité personnelle et de protéger le produit d'éventuels dommages. Veuillez consulter les consignes d'utilisation du produit pour plus de détails.

- L'électricité statique peut endommager les composants électroniques. Déchargez l'électricité statique de votre corps (en touchant un objet en métal relié à la terre par exemple) avant de toucher le produit.
- N'essayez pas d'intervenir sur le produit et ne le démontez jamais. Pour certains produits contenant une batterie remplaçable par l'utilisateur,

- veuillez lire et suivre les consignes contenues dans le manuel d'utilisation.
- Ne renversez pas d'aliments ou de liquide sur le produit et n'insérez jamais d'objets dans les orifices.
- N'utilisez pas ce produit à proximité d'un point d'eau, de zones très humides ou de condensation sauf si le produit a été spécifiquement conçu pour une application extérieure.
- Éloignez le produit des radiateurs et autres sources de chaleur.
- Débranchez toujours le produit de l'alimentation avant de le nettoyer et utilisez uniquement un chiffon sec non pelucheux.

INSTRUCCIONES DE SEGURIDAD

Las siguientes directrices de seguridad general se facilitan para ayudarle a garantizar su propia seguridad personal y para proteger el producto frente a posibles daños. No olvide consultar las instrucciones del usuario del producto para obtener más información.

- La electricidad estática puede resultar nociva para los componentes electrónicos. Descargue la electricidad estática de su cuerpo (p. ej., tocando algún metal sin revestimiento conectado a tierra) antes de tocar el producto.
- No intente realizar el mantenimiento del producto ni lo desmonte nunca. Para algunos productos con batería reemplazable por el usuario, lea y siga las instrucciones del manual de usuario.
- No derrame comida o líquidos sobre el producto y nunca deje que caigan objetos en las aberturas del mismo.
- No utilice este producto cerca del agua, en zonas con humedad o condensación elevadas a menos que el producto esté clasificado específicamente para aplicación en exteriores.
- Mantenga el producto alejado de los radiadores y de otras fuentes de calor.
- Desenchufe siempre el producto de la alimentación de red antes de limpiarlo y utilice solo un paño seco sin pelusa"

ISTRUZIONI PER LA SICUREZZA

Las siguientes directrices de seguridad general se facilitan para ayudarle a garantizar su propia seguridad personal y para proteger el producto frente a posibles daños. No olvide consultar las instrucciones del usuario del producto para obtener más información.

- La electricidad estática puede resultar nociva para los componentes electrónicos. Descargue la electricidad estática de su cuerpo (p. ej., tocando algún metal sin revestimiento conectado a tierra) antes de tocar el producto.
- No intente realizar el mantenimiento del producto ni lo desmonte nunca. Para algunos productos con batería reemplazable por el usuario, lea y siga las instrucciones del manual de usuario.
- No derrame comida o líquidos sobre el producto y nunca deje que caigan objetos en las aberturas del mismo.
- No utilice este producto cerca del agua, en zonas con humedad o condensación elevadas a menos que el producto esté clasificado específicamente para aplicación en exteriores.
- Mantenga el producto alejado de los radiadores y de otras fuentes de calor.
- Desenchufe siempre el producto de la alimentación de red antes de limpiarlo y utilice solo un paño seco sin pelusa"

VEILIGHEIDSINFORMATIE

De volgende algemene veiligheidsinformatie werd verstrekt om uw eigen persoonlijke veiligheid te waarborgen en uw product te beschermen tegen mogelijke schade. Denk eraan om de gebruikersinstructies van het product te raadplegen voor meer informatie.

- Statische elektriciteit kan schadelijk zijn voor elektronische componenten. Ontlaad de statische elektriciteit van uw lichaam (d.w.z. het aanraken van geaard bloot metaal) voordat u het product aanraakt.
- U mag nooit proberen het product te onderhouden en u mag het product nooit demonteren. Voor sommige producten met door de gebruiker te vervangen batterij, dient u de instructies in de gebruikershandleiding te lezen en te volgen.
- Mors geen voedsel of vloeistof op uw product en u mag nooit voorwerpen in de openingen van uw product duwen.
- Gebruik dit product niet in de buurt van water, gebieden met hoge vochtigheid of condensatie, tenzij het product specifiek geclassificeerd is voor gebruik buitenshuis.
- Houd het product uit de buurt van radiators en andere warmtebronnen.
- U dient het product steeds los te koppelen van de stroom voordat u het reinigt en gebruik uitsluitend een droge pluisvrije doek"

Disposing and Recycling Your Product

ENGLISH

EN



This symbol on the product or packaging means that according to local laws and regulations this product should be not be disposed of in household waste but sent for recycling. Please take it to a collection point designated by your local authorities once it has reached the end of its life, some will accept products for free. By recycling the product and its packaging in this manner you help to conserve the environment and protect human health.

D-Link and the Environment

At D-Link, we understand and are committed to reducing any impact our operations and products may have on the environment. To minimise this impact D-Link designs and builds its products to be as environmentally friendly as possible, by using recyclable, low toxic materials in both products and packaging.

D-Link recommends that you always switch off or unplug your D-Link products when they are not in use. By doing so you will help to save energy and reduce CO2 emissions.

To learn more about our environmentally responsible products and packaging please visit www.dlinkgreen.com.

DEUTSCH

DE



Dieses Symbol auf dem Produkt oder der Verpackung weist darauf hin, dass dieses Produkt gemäß bestehender örtlicher Gesetze und Vorschriften nicht über den normalen Hausmüll entsorgt werden sollte, sondern einer Wiederverwertung zuzuführen ist. Bringen Sie es bitte zu einer von Ihrer Kommunalbehörde entsprechend amtlich ausgewiesenen Sammelstelle, sobald das Produkt das Ende seiner Nutzungsdauer erreicht hat. Für die Annahme solcher Produkte erheben einige dieser Stellen keine Gebühren. Durch ein auf diese Weise durchgeführtes Recycling des Produkts und seiner Verpackung helfen Sie, die Umwelt zu schonen und die menschliche Gesundheit zu schützen.

D-Link und die Umwelt

D-Link ist sich den möglichen Auswirkungen seiner Geschäftstätigkeiten und seiner Produkte auf die Umwelt bewusst und fühlt sich verpflichtet, diese entsprechend zu mindern. Zu diesem Zweck entwickelt und stellt D-Link seine Produkte mit dem Ziel größtmöglicher Umweltfreundlichkeit her und verwendet wiederverwertbare, schadstoffarme Materialien bei Produktherstellung und Verpackung.

D-Link empfiehlt, Ihre Produkte von D-Link, wenn nicht in Gebrauch, immer auszuschalten oder vom Netz zu nehmen. Auf diese Weise helfen Sie, Energie zu sparen und CO2-Emissionen zu reduzieren.

Wenn Sie mehr über unsere umweltgerechten Produkte und Verpackungen wissen möchten, finden Sie entsprechende Informationen im Internet unter www.dlinkgreen.com.

FRANÇAIS**FR**

Ce symbole apposé sur le produit ou son emballage signifie que, conformément aux lois et réglementations locales, ce produit ne doit pas être éliminé avec les déchets domestiques mais recyclé. Veuillez le rapporter à un point de collecte prévu à cet effet par les autorités locales; certains accepteront vos produits gratuitement. En recyclant le produit et son emballage de cette manière, vous aidez à préserver l'environnement et à protéger la santé de l'homme.

D-Link et l'environnement

Chez D-Link, nous sommes conscients de l'impact de nos opérations et produits sur l'environnement et nous engageons à le réduire. Pour limiter cet impact, D-Link conçoit et fabrique ses produits de manière aussi écologique que possible, en utilisant des matériaux recyclables et faiblement toxiques, tant dans ses produits que ses emballages.

D-Link recommande de toujours éteindre ou débrancher vos produits D-Link lorsque vous ne les utilisez pas. Vous réaliserez ainsi des économies d'énergie et réduirez vos émissions de CO₂.

Pour en savoir plus sur les produits et emballages respectueux de l'environnement, veuillez consulter le www.dlinkgreen.com.

ESPAÑOL**ES**

Este símbolo en el producto o el embalaje significa que, de acuerdo con la legislación y la normativa local, este producto no se debe desechar en la basura doméstica sino que se debe reciclar. Llévelo a un punto de recogida designado por las autoridades locales una vez que ha llegado al fin de su vida útil; algunos de ellos aceptan recogerlos de forma gratuita. Al reciclar el producto y su embalaje de esta forma, contribuye a preservar el medio ambiente y a proteger la salud de los seres humanos.

D-Link y el medio ambiente

En D-Link, comprendemos y estamos comprometidos con la reducción del impacto que puedan tener nuestras actividades y nuestros productos en el medio ambiente. Para reducir este impacto, D-Link diseña y fabrica sus productos para que sean lo más ecológicos posible, utilizando materiales reciclables y de baja toxicidad tanto en los productos como en el embalaje.

D-Link recomienda apagar o desenchufar los productos D-Link cuando no se estén utilizando. Al hacerlo, contribuirá a ahorrar energía y a reducir las emisiones de CO₂.

Para obtener más información acerca de nuestros productos y embalajes ecológicos, visite el sitio www.dlinkgreen.com.

ITALIANO

IT



La presenza di questo simbolo sul prodotto o sulla confezione del prodotto indica che, in conformità alle leggi e alle normative locali, questo prodotto non deve essere smaltito nei rifiuti domestici, ma avviato al riciclo. Una volta terminato il ciclo di vita utile, portare il prodotto presso un punto di raccolta indicato dalle autorità locali. Alcuni questi punti di raccolta accettano gratuitamente i prodotti da riciclare. Scegliendo di riciclare il prodotto e il relativo imballaggio, si contribuirà a preservare l'ambiente e a salvaguardare la salute umana.

D-Link e l'ambiente

D-Link cerca da sempre di ridurre l'impatto ambientale dei propri stabilimenti e dei propri prodotti. Allo scopo di ridurre al minimo tale impatto, D-Link progetta e realizza i propri prodotti in modo che rispettino il più possibile l'ambiente, utilizzando materiali riciclabili a basso tasso di tossicità sia per i prodotti che per gli imballaggi.

D-Link raccomanda di spegnere sempre i prodotti D-Link o di scollegarne la spina quando non vengono utilizzati. In questo modo si contribuirà a risparmiare energia e a ridurre le emissioni di anidride carbonica.

Per ulteriori informazioni sui prodotti e sugli imballaggi D-Link a ridotto impatto ambientale, visitate il sito all'indirizzo www.dlinkgreen.com.

NEDERLANDS

NL



Dit symbool op het product of de verpakking betekent dat dit product volgens de plaatselijke wetgeving niet mag worden weggegooid met het huishoudelijk afval, maar voor recyclage moeten worden ingeleverd. Zodra het product het einde van de levensduur heeft bereikt, dient u het naar een inzamelpunt te brengen dat hiertoe werd aangeduid door uw plaatselijke autoriteiten, sommige autoriteiten accepteren producten zonder dat u hiervoor dient te betalen. Door het product en de verpakking op deze manier te recyclen helpt u het milieu en de gezondheid van de mens te beschermen.

D-Link en het milieu

Bij D-Link spannen we ons in om de impact van onze handelingen en producten op het milieu te beperken. Om deze impact te beperken, ontwerpt en bouwt D-Link zijn producten zo milieuvriendelijk mogelijk, door het gebruik van recycleerbare producten met lage toxiciteit in product en verpakking.

D-Link raadt aan om steeds uw D-Link producten uit te schakelen of uit de stekker te halen wanneer u ze niet gebruikt. Door dit te doen bespaart u energie en beperkt u de CO₂-emissies.

Breng een bezoek aan www.dlinkgreen.com voor meer informatie over onze milieuverantwoorde producten en verpakkingen.

POLSKI**PL**

Ten symbol umieszczony na produkcie lub opakowaniu oznacza, że zgodnie z miejscowym prawem i lokalnymi przepisami niniejszego produktu nie wolno wyrzucać jak odpady czy śmieci z gospodarstwa domowego, lecz należy go poddać procesowi recyklingu. Po zakończeniu użytkowania produktu, niektóre odpowiednie do tego celu podmioty przyjmą takie produkty nieodpłatnie, dlatego prosimy dostarczyć go do punktu zbiórki wskazanego przez lokalne władze. Poprzez proces recyklingu i dzięki takiemu postępowaniu z produktem oraz jego opakowaniem, pomogą Państwo chronić środowisko naturalne i dbać o ludzkie zdrowie.

D-Link i środowisko

D-Link podchodzimy w sposób świadomy do ochrony otoczenia oraz jesteśmy zaangażowani w zmniejszanie wpływu naszych działań i produktów na środowisko naturalne. W celu zminimalizowania takiego wpływu firma D-Link konstruuje i wytwarza swoje produkty w taki sposób, aby były one jak najbardziej przyjazne środowisku, stosując do tych celów materiały nadające się do powtórnego wykorzystania, charakteryzujące się małą toksycznością zarówno w przypadku samych produktów jak i opakowań.

Firma D-Link zaleca, aby Państwo zawsze prawidłowo wyłączali z użytku swoje produkty D-Link, gdy nie są one wykorzystywane. Postępując w ten sposób pozwalają Państwo oszczędzać energię i zmniejszać emisje CO₂.

Aby dowiedzieć się więcej na temat produktów i opakowań mających wpływ na środowisko prosimy zapoznać się ze stroną Internetową www.dlinkgreen.com.

ČESKY**CZ**

Tento symbol na výrobku nebo jeho obalu znamená, že podle místně platných předpisů se výrobek nesmí vyhazovat do komunálního odpadu, ale odeslat k recyklaci. Až výrobek doslouží, odneste jej prosím na sběrné místo určené místními úřady k tomuto účelu. Některá sběrná místa přijímají výrobky zdarma. Recyklací výrobku i obalu pomáháte chránit životní prostředí i lidské zdraví.

D-Link a životní prostředí

Ve společnosti D-Link jsme si vědomi vlivu našich provozů a výrobků na životní prostředí a snažíme se o minimalizaci těchto vlivů. Proto své výrobky navrhujeme a vyrábíme tak, aby byly co nejekologičtější, a ve výrobcích i obalech používáme recyklovatelné a nízkotoxické materiály.

Společnost D-Link doporučuje, abyste své výrobky značky D-Link vypnuli nebo vytáhli ze zásuvky vždy, když je nepoužíváte. Pomůžete tak šetřit energii a snížit emise CO₂.

Více informací o našich ekologických výrobcích a obalech najdete na adrese www.dlinkgreen.com.

MAGYAR**HU**

Ez a szimbólum a terméken vagy a csomagoláson azt jelenti, hogy a helyi törvényeknek és szabályoknak megfelelően ez a termék nem semmisíthető meg a háztartási hulladékkal együtt, hanem újrahasznosításra kell küldeni. Kérjük, hogy a termék élettartamának elteltét követően vigye azt a helyi hatóság által kijelölt gyűjtőhelyre. A termékek egyes helyeken ingyen elhelyezhetők. A termék és a csomagolás újrahasznosításával segíti védeni a környezetet és az emberek egészségét.

A D-Link és a környezet

A D-Linknél megértjük és elköteleztük magunkat a műveleteink és termékeink környezetre gyakorolt hatásainak csökkentésére. Az ezen hatás csökkentése érdekében a D-Link a lehető leginkább környezetbarát termékeket tervez és gyárt azáltal, hogy újrahasznosítható, alacsony károsanyag-tartalmú termékeket gyárt és csomagolásokat alkalmaz.

A D-Link azt javasolja, hogy mindig kapcsolja ki vagy húzza ki a D-Link termékeket a tápforrásból, ha nem használja azokat. Ezzel segít az energia megtakarításában és a széndioxid kibocsátásának csökkentésében.

Környezetbarát termékeinkről és csomagolásainkról további információkat a www.dlinkgreen.com weboldalon tudhat meg.

NORSK**NO**

Dette symbolet på produktet eller forpakningen betyr at dette produktet ifølge lokale lover og forskrifter ikke skal kastes sammen med husholdningsavfall, men leveres inn til gjenvinning. Vennligst ta det til et innsamlingssted anvist av lokale myndigheter når det er kommet til slutten av levetiden. Noen steder aksepteres produkter uten avgift. Ved på denne måten å gjenvinne produktet og forpakningen hjelper du å verne miljøet og beskytte folks helse.

D-Link og miljøet

Hos D-Link forstår vi oss på og er forpliktet til å minske innvirkningen som vår drift og våre produkter kan ha på miljøet. For å minimalisere denne innvirkningen designer og lager D-Link produkter som er så miljøvennlig som mulig, ved å bruke resirkulerbare, lav-toksiske materialer både i produktene og forpakningen.

D-Link anbefaler at du alltid slår av eller frakobler D-Link-produkter når de ikke er i bruk. Ved å gjøre dette hjelper du å spare energi og å redusere CO2-utslipp.

For mer informasjon angående våre miljøansvarlige produkter og forpakninger kan du gå til www.dlinkgreen.com.

DANSK

DK



Dette symbol på produktet eller emballagen betyder, at dette produkt i henhold til lokale love og regler ikke må bortskaffes som husholdningsaffald, mens skal sendes til genbrug. Indlever produktet til et indsamlingssted som angivet af de lokale myndigheder, når det er nået til slutningen af dets levetid. I nogle tilfælde vil produktet blive modtaget gratis. Ved at indlevere produktet og dets emballage til genbrug på denne måde bidrager du til at beskytte miljøet og den menneskelige sundhed.

D-Link og miljøet

Hos D-Link forstår vi og bestræber os på at reducere enhver indvirkning, som vores aktiviteter og produkter kan have på miljøet. For at minimere denne indvirkning designer og producerer D-Link sine produkter, så de er så miljøvenlige som muligt, ved at bruge genanvendelige materialer med lavt giftighedsniveau i både produkter og emballage.

D-Link anbefaler, at du altid slukker eller frakobler dine D-Link-produkter, når de ikke er i brug. Ved at gøre det bidrager du til at spare energi og reducere CO₂-udledningerne.

Du kan finde flere oplysninger om vores miljømæssigt ansvarlige produkter og emballage på www.dlinkgreen.com.

SUOMI

FI



Tämä symboli tuotteen pakkauksessa tarkoittaa, että paikallisten lakien ja säännösten mukaisesti tätä tuotetta ei pidä hävittää yleisen kotitalousjätteen seassa vaan se tulee toimittaa kierrätettäväksi. Kun tuote on elinkaarensa päässä, toimita se lähimpään viranomaisten hyväksymään kierrätyspisteeseen. Kierrättämällä käytetyn tuotteen ja sen pakkauksen autat tukemaan sekä ympäristön että ihmisten terveyttä ja hyvinvointia.

D-Link ja ympäristö

D-Link ymmärtää ympäristönsuojelun tärkeyden ja on sitoutunut vähentämään tuotteistaan ja niiden valmistuksesta ympäristölle mahdollisesti aiheutuvia haittavaikutuksia. Nämä negatiiviset vaikutukset minimoidakseen D-Link suunnittelee ja valmistaa tuotteensa mahdollisimman ympäristöystävällisiksi käyttämällä kierrätettäviä, alhaisia pitoisuuksia haitallisia aineita sisältäviä materiaaleja sekä tuotteissaan että niiden pakkauksissa.

Suosittellemme, että irrotat D-Link-tuotteesi virtalähteestä tai sammutat ne aina, kun ne eivät ole käytössä. Toimimalla näin autat säästämään energiaa ja vähentämään hiilidioksiidipäästöjä.

Lue lisää ympäristöystävällisistä D-Link-tuotteista ja pakkauksistamme osoitteesta www.dlinkgreen.com.

SVENSKA

SE

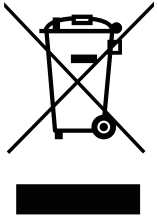

Den här symbolen på produkten eller förpackningen betyder att produkten enligt lokala lagar och föreskrifter inte skall kastas i hushållssoporna utan i stället återvinnas. Ta den vid slutet av dess livslängd till en av din lokala myndighet utsedd uppsamlingsplats, vissa accepterar produkter utan kostnad. Genom att på detta sätt återvinna produkten och förpackningen hjälper du till att bevara miljön och skydda människors hälsa.

D-Link och miljön

På D-Link förstår vi och är fast beslutna att minska den påverkan våra verksamheter och produkter kan ha på miljön. För att minska denna påverkan utformar och bygger D-Link sina produkter för att de ska vara så miljövänliga som möjligt, genom att använda återvinningsbara material med låg gifthalt i både produkter och förpackningar.

D-Link rekommenderar att du alltid stänger av eller kopplar ur dina D-Link produkter när du inte använder dem. Genom att göra detta hjälper du till att spara energi och minska utsläpp av koldioxid.

För mer information om våra miljöansvariga produkter och förpackningar www.dlinkgreen.com.

PORTUGUÊS

PT

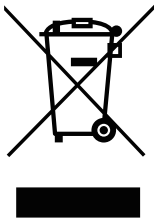

Este símbolo no produto ou embalagem significa que, de acordo com as leis e regulamentações locais, este produto não deverá ser eliminado juntamente com o lixo doméstico mas enviado para a reciclagem. Transporte-o para um ponto de recolha designado pelas suas autoridades locais quando este tiver atingido o fim da sua vida útil, alguns destes pontos aceitam produtos gratuitamente. Ao reciclar o produto e respectiva embalagem desta forma, ajuda a preservar o ambiente e protege a saúde humana.

A D-Link e o ambiente

Na D-Link compreendemos e comprometemo-nos com a redução do impacto que as nossas operações e produtos possam ter no ambiente. Para minimizar este impacto a D-Link concebe e constrói os seus produtos para que estes sejam o mais inofensivos para o ambiente possível, utilizando materiais recicláveis e não tóxicos tanto nos produtos como nas embalagens.

A D-Link recomenda que desligue os seus produtos D-Link quando estes não se encontrarem em utilização. Com esta acção ajudará a poupar energia e reduzir as emissões de CO₂.

Para saber mais sobre os nossos produtos e embalagens responsáveis a nível ambiental visite www.dlinkgreen.com.