



User Manual

Vigilance Full HD H.265 Outdoor PoE Mini Dome Camera

DCS-4802E

Preface

D-Link reserves the right to revise this publication and to make changes in the content hereof without obligation to notify any person or organization of such revisions or changes. Information in this document may become obsolete as our services and websites develop and change.

Manual Revisions

Revision	Date	Description
1.00	08/19/2015	DCS-4802E Revision A1 with firmware version 1.00
1.10	03/09/2016	Added DCS-37-1/DCS-37-2 information
1.20	12/05/2018	Update safety & EN55032 Class A statement
1.21	12/05/2018	Add DCS-37-3 optional bracket
2.00	25/10/2018	DCS-4802E Revision B1 with firmware version 2.00

Trademarks

D-Link and the D-Link logo are trademarks or registered trademarks of D-Link Corporation or its subsidiaries in the United States or other countries. All other company or product names mentioned herein are trademarks or registered trademarks of their respective companies.

Copyright © 2018 D-Link Corporation.

All rights reserved. This publication may not be reproduced, in whole or in part, without prior expressed written permission from D-Link Corporation.

Table of Contents

Product Overview.....	4	Event Management.....	44
Package Contents.....	4	Advanced Setup.....	53
Introduction.....	5	Advanced.....	53
System Requirements	5	Camera Configuration.....	59
Features.....	6	Camera Options	63
Hardware Overview	7	Camera Info.....	63
Installation.....	8	Time	64
Connecting the Camera	8	Administration Settings	67
Mounting the Camera.....	9	Camera Log.....	70
Using the DCS-37-1 Mount (optional).....	11	Technical Specifications.....	71
Using the DCS-37-2 Mount (optional).....	13		
Using the DCS-37-3 Mount (optional).....	15		
Waterproofing Your Installation	16		
Software Installation	19		
Configuration	22		
Using the Configuration Interface.....	22		
Live Video	24		
Setup Wizard	26		
Network Setup Wizard.....	27		
Motion Detection Setup Wizard.....	29		
Settings	31		
Network Settings	31		
Camera Settings.....	37		

Product Overview

Package Contents



DCS-4802E Vigilance Full HD H.265 Outdoor PoE Mini Dome Camera



Cable Waterproofing Connector



Rubber Power Connector Plug



Mounting Kit



CD-ROM with User Manual and software



Quick Installation Guide



If any of the above items are missing, please contact your reseller.

Safety Notice: Installation and servicing should be done by certified technicians so as to conform to all local codes and prevent voiding your warranty.

Introduction

Congratulations on your purchase of the DCS-4802E Vigilance Full HD H.265 Outdoor PoE Mini Dome Camera. The DCS-4802E is a professional surveillance and security solution for small, medium, and large enterprises alike. The DCS-4802E uses a Full HD progressive scan CMOS sensor; the professional sensor results in low noise and high sensitivity capabilities ideal for surveillance applications.

The DCS-4802E is a complete system with a built-in CPU and incorporates a web server, allowing it to transmit excellent real-time Full HD resolution video for security and outdoor surveillance.

The DCS-4802E can be accessed remotely, controlled and configured from any PC/Notebook over your local network or through the Internet via a web browser. The simple installation and intuitive web-based interface offer easy configuration across the full range of its advanced feature set, including granular control over multiple video streams with different configurations and multicast video streams which helps you manage your network load.

The DCS-4802E has an IP66 certified weatherproof housing designed for both indoor and outdoor applications. The built-in removable IR-cut filter and IR LEDs give the DCS-4802E the capability to view up to 20M at night. The DCS-4802E also incorporates Power over Ethernet (PoE), allowing it to be easily installed in a variety of locations without the need for supplemental power cabling. The combination of IP66 weatherproof housing, IR-Cut Filter, IR LEDs, and PoE make the DCS-4802E an ideal solution for a dependable and cost-effective 24 hour surveillance solution with easy clutter-free installation.

System Requirements

- Computer with Microsoft Windows® 10, 8, or 7, Mac OSX 10.9 or above
- Internet Explorer 9 or higher for Windows®, Firefox 2-51, 52 ESR, Chrome 42 or higher, or Safari 9 or higher for MacOS X
- Existing 10/100 Ethernet-based network with an available 802.3af Power over Ethernet (PoE) port

Features

H.265 Compression

The DCS-4802E supports the latest H.265 compression algorithm to bring out the best combination of performance, quality, bandwidth, and storage space.

Simple to Maintain

The DCS-4802E is a stand-alone system with a built-in CPU, requiring no special hardware or software. The DCS-4802E can be viewed and managed through most web browsers, including Internet Explorer®, Firefox®, and Safari®.

Supports a Variety of Platforms

With support for TCP/IP networking, HTTP, and other Internet related protocols, the DCS-4802E can also be integrated easily into other Internet/ Intranet applications because of its standards-based features. The DCS-4802E works with any 10/100 Ethernet network, making the DCS-4802E easy to integrate into your existing network environment.

Advanced Event Management

The DCS-4802E can be set up to send e-mail notifications with snapshots when an event occurs, such as when motion is detected. Events can be triggered from several sources, such as motion detection and time based events.

IR LEDs for Day and Night Functionality

The built-in infrared LEDs enable night time viewing of up to 20 meters.

IP66 Weatherproof Housing

The DCS-4802E uses an IP66 weatherproof housing, allowing you to rest assured that in the toughest of conditions, it will continue to provide round-the-clock surveillance.

PoE (Power over Ethernet) for Flexible Installation

The DCS-4802E can draw all the power it needs from a PoE switch or PoE injector for a simple and clutter-free installation.

Remote Monitoring Utility

The D-ViewCam application adds enhanced features and functionality for the Network Camera and allows administrators to configure and access the Network Camera from a remote site via Intranet or Internet. Other features include image monitoring, recording images to a hard drive, viewing up to 32 cameras on one screen, and taking snapshots.

Hardware Overview

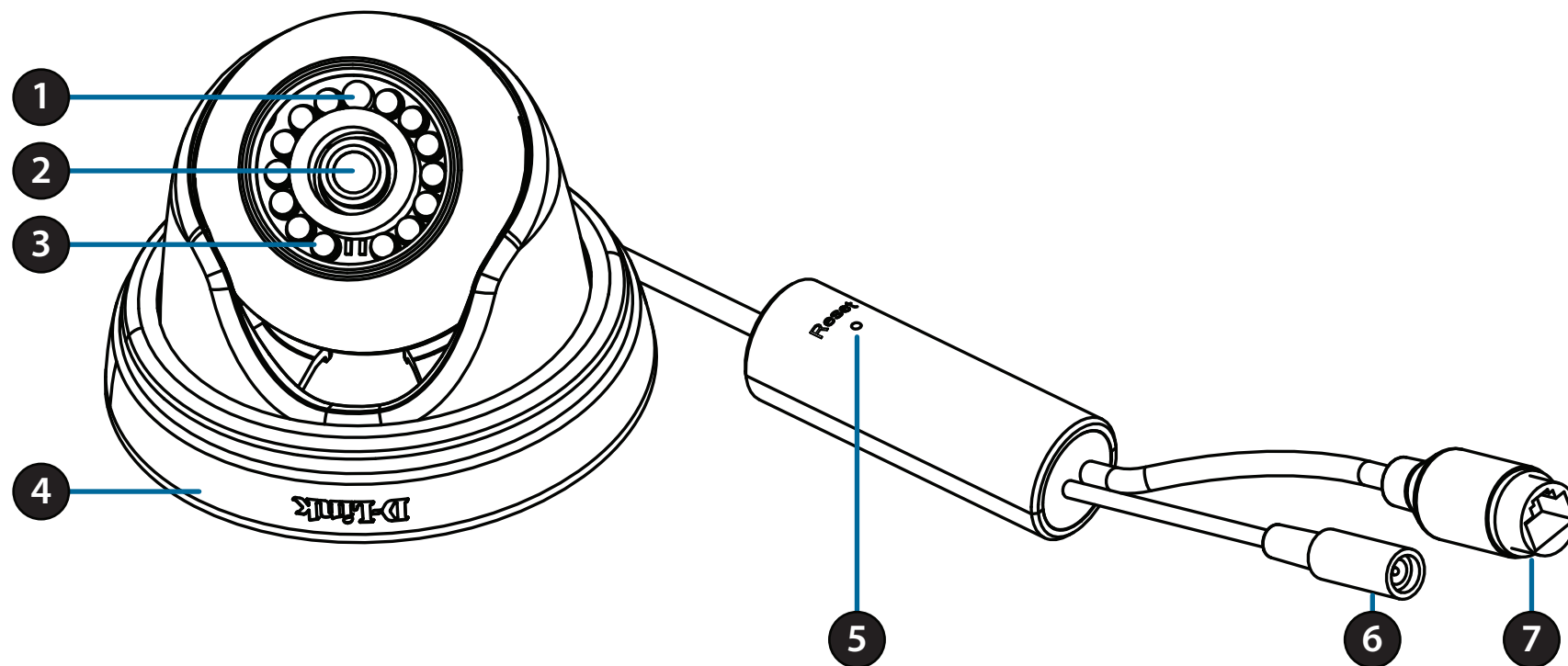

1	Light Sensor	Detects lighting conditions
2	Camera Lens	Fixed lens to record video of the surrounding area
3	IR LEDs	Provide illumination for low-light environments
4	Camera Base Cover	Covers the mounting holes on the camera base
5	Reset Button	Press and hold for 10 seconds to reset camera back to the factory default settings
6	Power Connector	Connects to an optional 12V, 1.5 A power adapter (not included)
7	Ethernet Jack	RJ-45 connector for Ethernet which can also be used to power the camera using Power over Ethernet (PoE)

Installation

Connecting the Camera

You can power the DCS-4802E two different ways: through PoE or through a power adapter.

Powering the camera through PoE (Class 2):

Connect an Ethernet cable to the LAN(PoE) port on the camera. Connect the other end of the cable to your PoE switch or PoE injector.

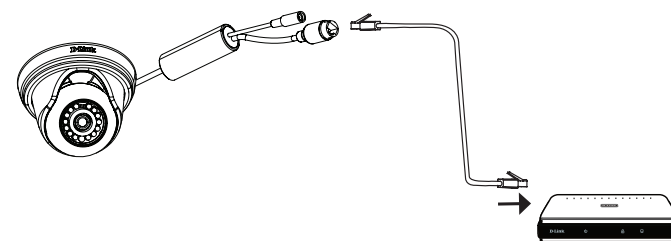

Powering the camera through a power adapter (not included):

Connect a 12 V, 1.5 A power adapter to the power connector.

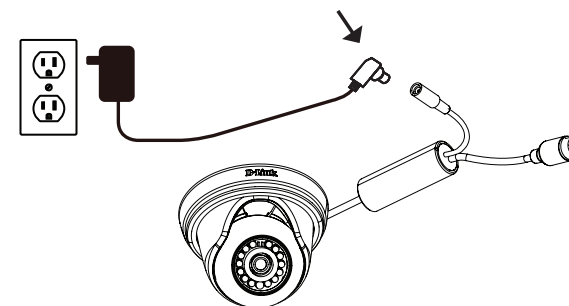

Connect an Ethernet cable to the LAN(PoE) port on the camera. Connect the other end of the cable to your network.

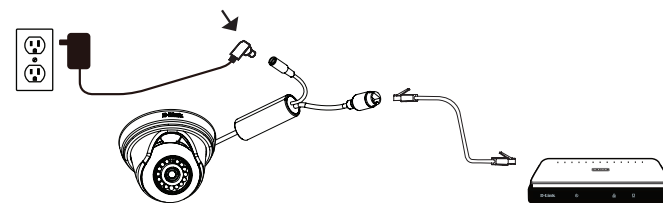

Mounting the Camera

It is highly recommended that you configure and test your camera before mounting it.

Step 1

Place the mounting sticker where you want to position the camera.

Use a 6 mm drill bit to make the required holes approximately 25 mm deep, then insert the wall anchors into the holes.

If you are running the camera cables through the wall or ceiling, drill a hole in the center and pull the cables through the hole.

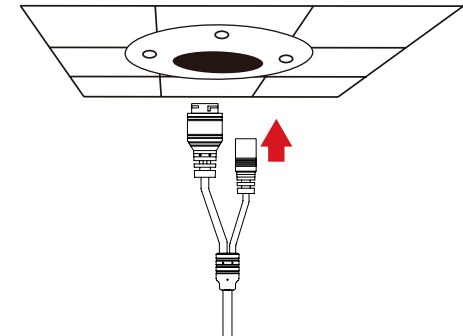
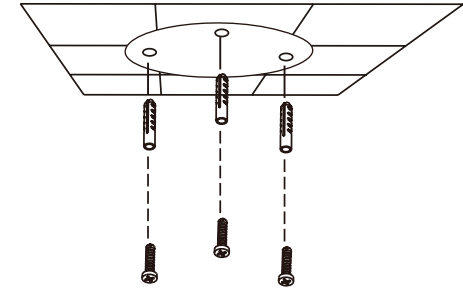

Step 2

Use the screws provided to mount the camera to the wall.

If you are running the camera cables out the side of the camera, guide the camera cables through the cable channel on the base.

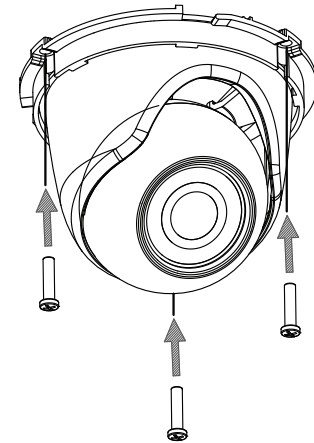

Step 3

Attach the camera base cover by lining up the cable channel on it with the mark on the camera base, then turn the camera base cover clockwise until it clicks.

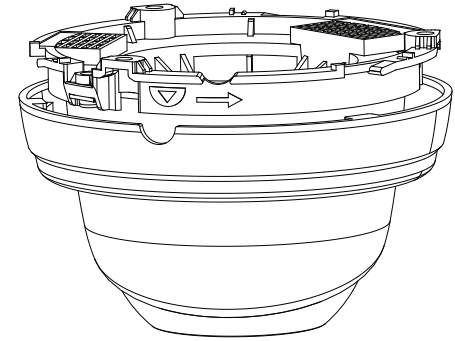

Using the DCS-37-1 Mount (optional)

To mount the camera with the DCS-37-1 mount, follow the instructions below.

Step 1

Place the DCS-37-1 mounting sticker in the desired location, then use a 6 mm drill bit to drill the required holes 25 mm deep and insert the wall anchors into the holes. If you plan to pass cables through the wall, you will also need to drill a hole for the cable channel.

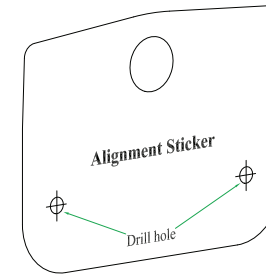

Step 2

Use the provided screws to mount the DCS-37-1 to the wall.

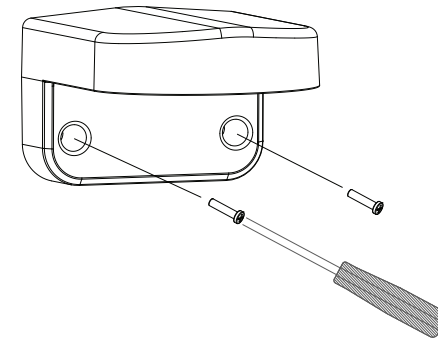

Step 3

Remove the cover from the camera.

Pass the camera connectors through the back or bottom cable channel on the DCS-37-1. Use the provided screws to mount the camera to the DCS-37-1 using the set of mounting holes marked B.

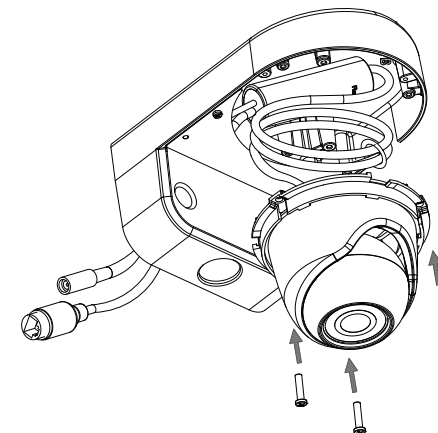

Step 4

Adjust the angle of the camera as desired, then put the cover back on the camera and rotate it clockwise to lock it in place.

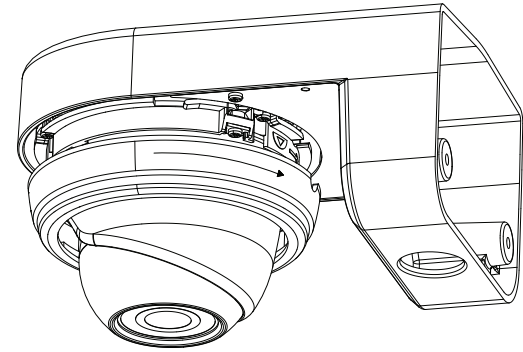

Step 5

If you are passing the camera cables through the wall, place the rubber stopper into the bottom cable channel to seal it.

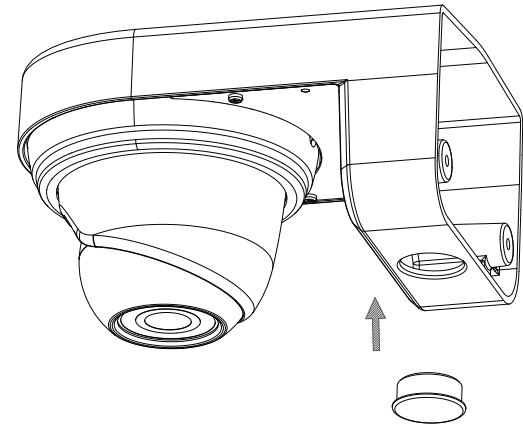

Using the DCS-37-2 Mount (optional)

To mount the camera with the DCS-37-2 mount, follow the instructions below.

Step 1

Place the DCS-37-2 mounting sticker in the desired location, then use a 6 mm drill bit to drill the required holes 25 mm deep and insert the wall anchors into the holes. If you plan to pass cables through the wall, you will also need to drill a hole for the cable channel.

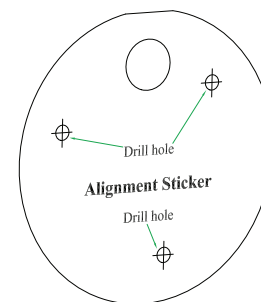

Step 2

Use the provided screws to mount the DCS-37-2 to the wall using the inner mounting holes.

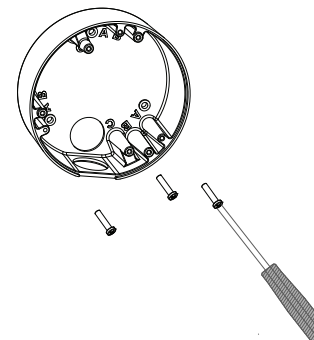

Step 3

Remove the cover from the camera.

Pass the camera connectors through the back or side cable channel on the DCS-37-2. Use the provided screws to mount the camera to the DCS-37-2 using the set of mounting holes marked B.

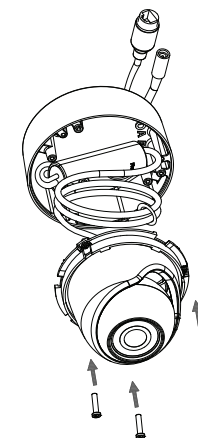

Step 4

Adjust the angle of the camera as desired, then put the cover back on the camera and rotate it clockwise to lock it in place.

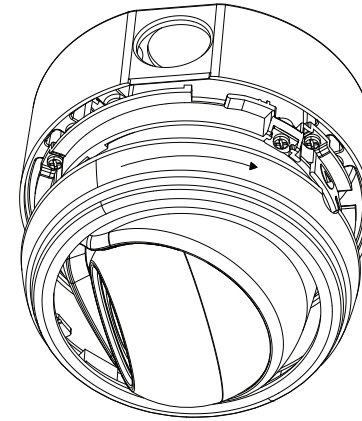

Step 5

If you are passing the camera cables through the wall, place the rubber stopper into the side cable channel to seal it.

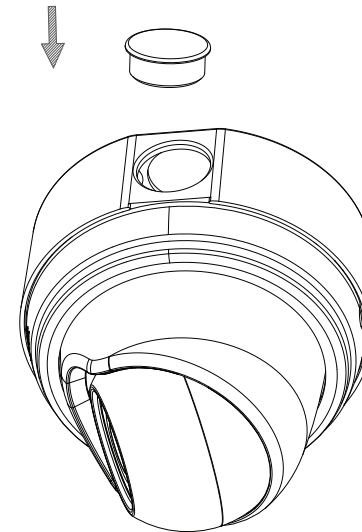

Using the DCS-37-3 Mount (optional)

To mount the camera with the DCS-37-3 mount, follow the instructions below.

Step 1

Place the DCS-37-3 mounting sticker in the desired location, then use a 6 mm drill bit to drill the required holes 25 mm deep and insert the wall anchors into the holes. If you plan to pass cables through the wall, you will also need to drill a hole for the cable channel.

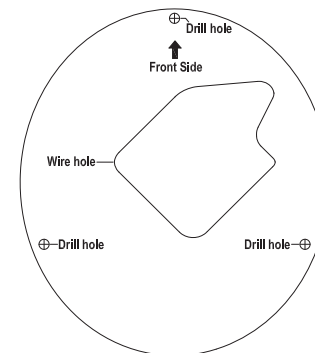

Step 2

Use the provided screws to mount the DCS-37-3 to the wall using the inner mounting holes.

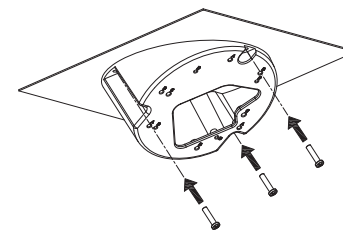

Step 3

Remove the cover from the camera.

Pass the camera connectors through the cable channel on the DCS-37-3. Use the provided screws to mount the camera to the DCS-37-3 using the set of mounting holes marked B.

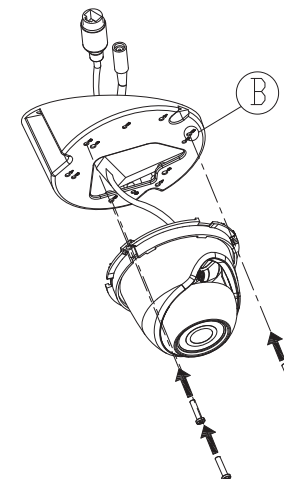

Step 4

Adjust the angle of the camera as desired, then put the cover back on the camera and rotate it clockwise to lock it in place.

Step 5

Attach the camera cover.

Waterproofing Your Installation

To waterproof your camera installation, follow the instructions below. Round Ethernet cable, a crimping tool, and RJ-45 plugs are required for this procedure.

Step 1

Place the washer around the base of the Ethernet connector as shown.

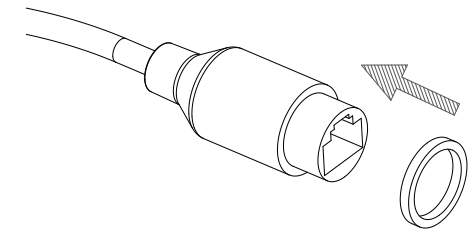

Step 2

Thread bare Ethernet cable through the waterproof connector as shown, then crimp an RJ-45 plug onto the cable.

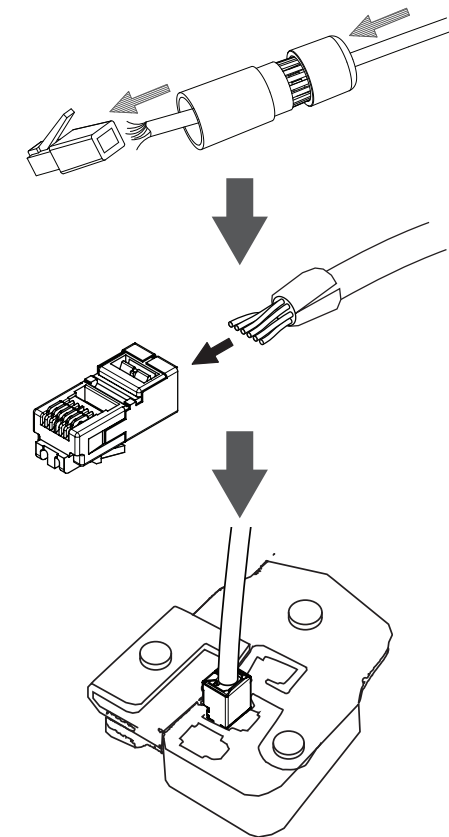

Step 3

Connect the RJ-45 plug into the Ethernet connector, then screw the waterproof connector to the Ethernet connector by turning it about a half-turn clockwise.

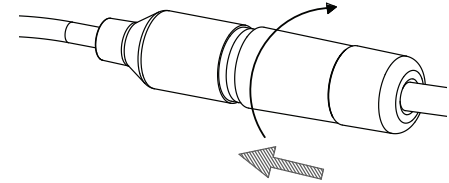
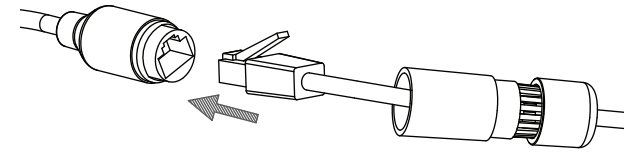

Step 4

Screw the back part of the waterproof connector clockwise until there is a tight seal around the Ethernet cable.

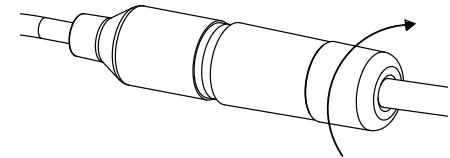

If you are using PoE to power your camera, use the included rubber power connector plug to the power connector.

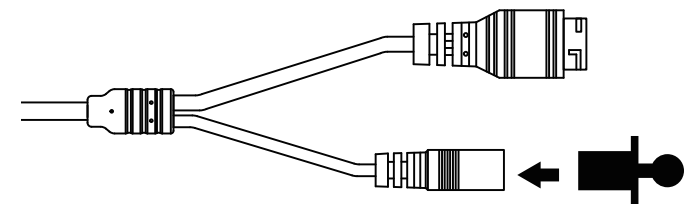

If you are using a power adapter (not included) to power your camera, wind waterproof tape around the connection in an overlapping manner to cover it.

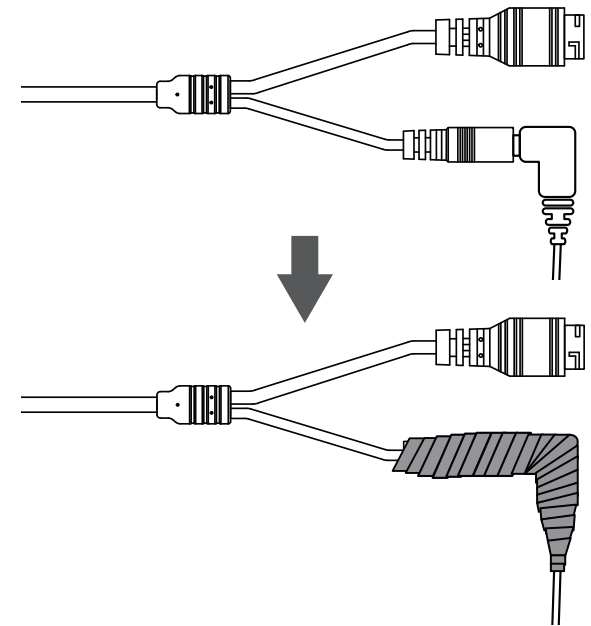

Software Installation

Step 1

Insert the DCS-4802E CD into your computer's CD-ROM drive to begin the installation.

If the Autorun function on your computer is disabled, or if the D-Link Launcher fails to start automatically, click the Start button and type **D:\autorun.exe** (where D: represents the drive letter of your CD-ROM drive) and press Enter.



Step 2

Click on the **D-Link Setup Wizard SE** icon that was created in your Windows Start menu (**Start > D-Link > Setup Wizard SE**).

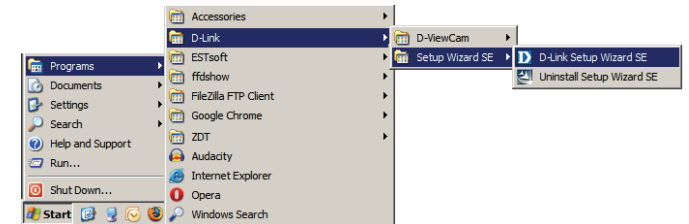

Step 3

The Setup Wizard will appear and display the MAC address and IP address of your camera(s). If you have a DHCP server on your network, a valid IP Address will be displayed. If your network does not use a DHCP server, the network camera's default static IP **192.168.0.20** will be displayed.

Select your camera, then click the **Wizard** button to continue.

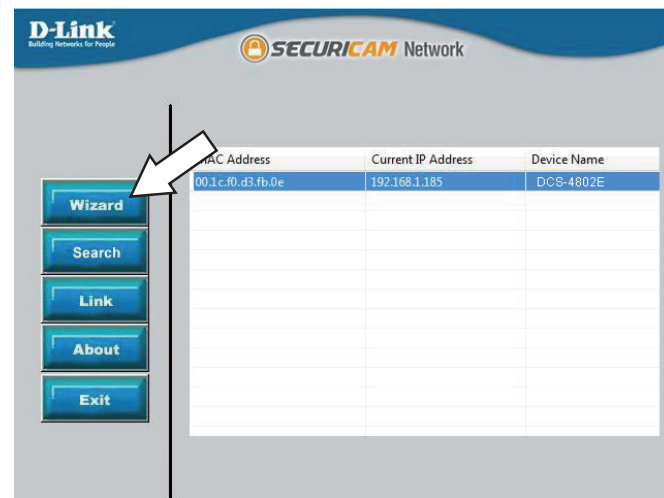

Step 4

Enter the Admin ID and password. When logging in for the first time, the default Admin ID is **admin** with the password left blank.

Click the checkboxes if you wish to change the admin ID and password for the camera, and enter the new ID and password you wish to use.

Click **Next** to continue.

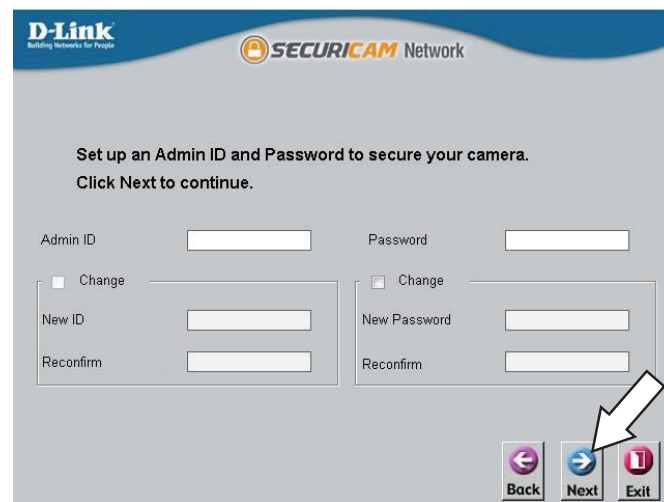

Step 5

Select **DHCP** if your camera obtains an IP address automatically from a DHCP server such as a router. Select **Static IP** if you want to manually enter the IP settings for the camera.

Click **Next** to continue.

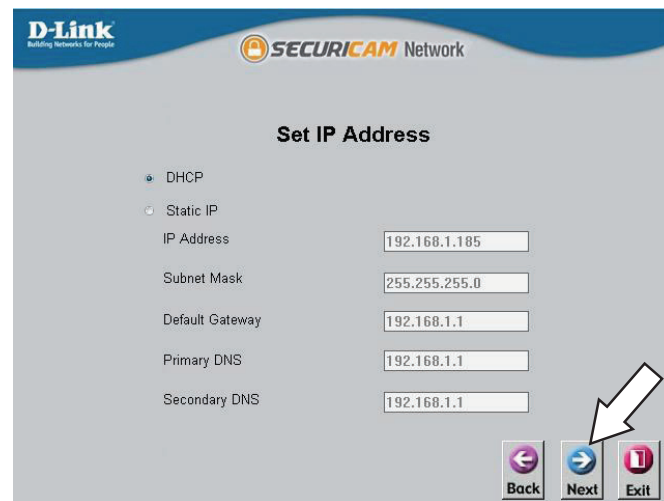

Step 6

Take a moment to confirm your settings and click **Restart**.

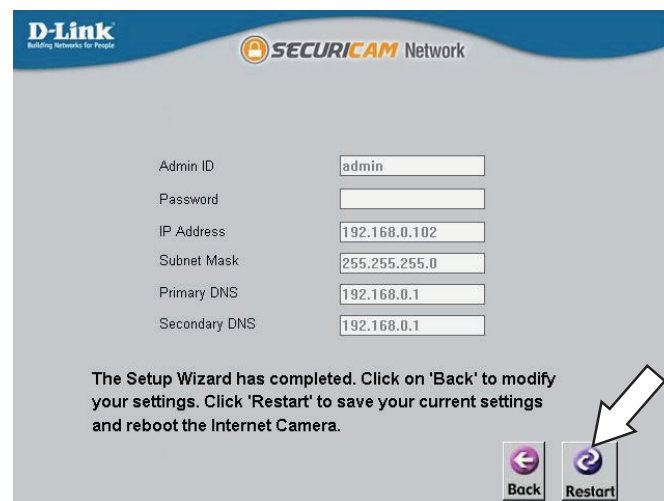

Configuration

Using the Configuration Interface

After completing the Camera Installation Wizard, you are ready to use your camera. The camera's built-in Web configuration utility is designed to allow you to easily access and configure your DCS-4802E. At the end of the wizard, click **Link**, or enter the IP address of your camera into a web browser, such as Firefox. To log in, use the User name **admin** and the password you created in the Installation Wizard. If you did not create a password, the default password is blank. After entering your password, click **OK**.

Step 1

Click on the **D-Link Setup Wizard SE** icon that was created in your Windows Start menu (**Start > D-Link > Setup Wizard SE**).

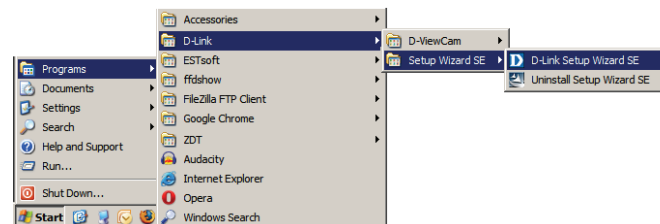

Step 2

Select the camera and click **Link** to access the web configuration.

The Setup Wizard will automatically open your web browser to the IP address of the camera.

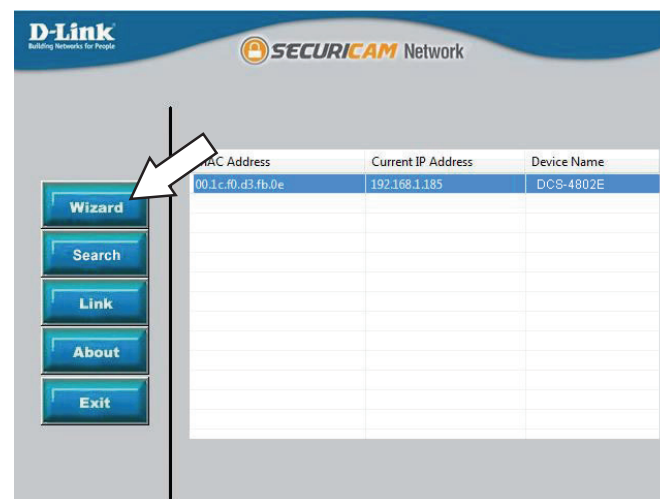

Step 3

The first time you connect to the camera, you will be asked to set a password for the administrator account. After entering a password, click **Save**.

OR

Under Password, enter the same password configured during setup and click **Login** to continue.

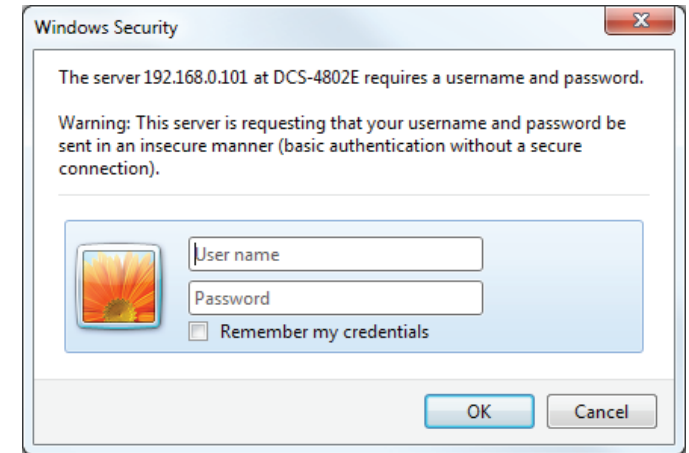

Step 4

This section displays your camera's live video. You can select your video profile and view or operate the camera.











Live Video

This section shows your camera's live video. You may select any of the available icons listed below to operate the camera. You may also select your language using the drop-down menu on the left side of the screen.



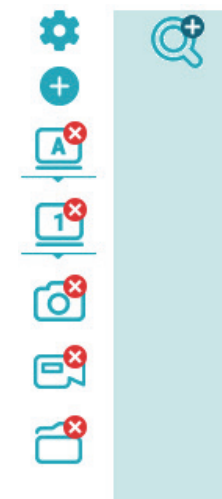

If your view window area is less than your frame size, you can click and drag on the live video to move the camera view around. Refer to **"Video Stream" on page 42**.

Note: If a system error message appears when clicking the snap or record buttons, you may need to (re)install the **Microsoft Visual C++ 2010 Redistributable Package (x86)** found on the included CD or download it from the Microsoft support site.

	Setup	Clicking this will take you to the camera configuration pages.
	Edit Toolbar	Clicking this will allow you to add and remove icons from the toolbar. This lets you create a custom toolbar with only the options you want.
	Window Size	You can choose between various screen sizes for your camera's video: <ul style="list-style-type: none"> ▪ Auto Screen: Automatically resize the camera video to match your browser window ▪ Full Screen: View your camera video using the entire screen ▪ 100% Screen: View your camera's video at 100% size ▪ 50% Screen: View your camera's video at 50% size ▪ 25% Screen: View your camera's video at 25% size
	Video Profile 1/2	Select a video profile to use. For more on setting up your video profiles, refer to "Video Stream" on page 42 .
	Take a Snapshot	This will save a snapshot to your PC using the storage folder you have selected.
	Record a Video Clip	This will start recording a video clip to your PC using the storage folder you have selected. Click it again to stop recording. If you close the browser window, the recording will stop.
	Set a Storage Folder	Select a storage folder to save snapshots and video clips to.
	Zoom In/Out	Click this and use the slider to zoom in and out of your camera's video.



You can find these icons in the top-right corner of the Live Video screen:

	Alarm	This will flash red when motion is detected.
	Record Status	This will turn red when the camera is recording.
	Help	Click this to open a window that describes the Live Video controls.
	Logout	Click this to log out of the web interface.

Setup Wizard

This page lets your use setup wizards to walk you through setting up your camera's network and motion detection settings.

Network Setup Wizard: Click on this button to start the Network Setup Wizard. Refer to **"Network Setup Wizard" on page 27**.

Motion Detection Setup Wizard: Click on this button to start the Motion Detection Setup Wizard. Refer to **"Motion Detection Setup Wizard" on page 29**.

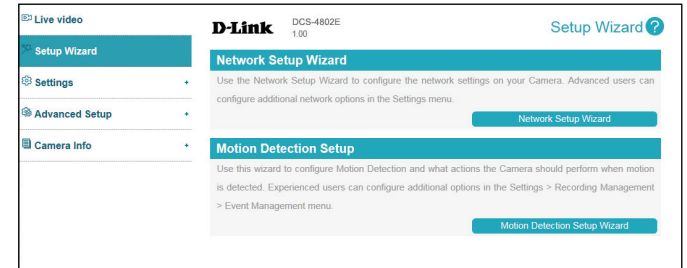

Network Setup Wizard

This wizard will guide you through a step-by-step process to configure your camera and connect it to the Internet. Click **Next** to continue.

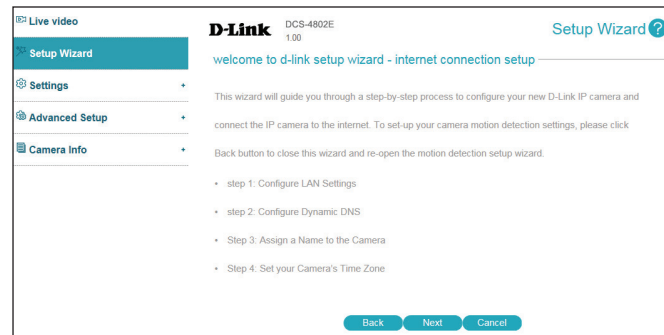

Step 1:

Select how the camera will connect to the Internet.

- If your camera is connected to a router, or you are unsure how your camera will connect to the Internet, select **DHCP**.
- Select **Static IP Client** if your Internet Service Provider has provided you with connection settings, or if you wish to set a static address within your home network. Enter the correct configuration information and click **Next** to continue.
- If you are using PPPoE, select **PPPoE** and enter your user name and password.

Click **Next** to continue.

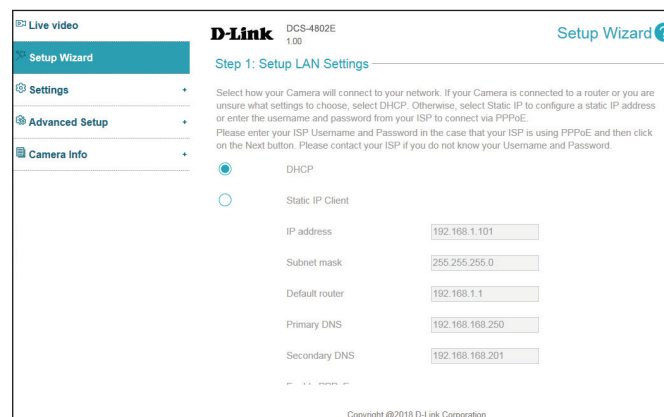

Step 2:

If you have a Dynamic DNS account and would like the camera to update your IP address automatically, select **Enable DDNS** and enter your host information. Click **Next** to continue.

The screenshot shows the 'Step 2: Configure Dynamic DNS' screen in the D-Link Setup Wizard. The left sidebar contains 'Setup Wizard', 'Settings', 'Advanced Setup', and 'Camera Info'. The main content area has a heading 'step 2: Configure Dynamic DNS' and a sub-heading 'step 2: Configure Dynamic DNS'. Below this, there is a paragraph: 'If you have a Dynamic DNS account, you can configure your Camera to update your external IP address automatically by enabling DDNS and entering your account details. Click Next to continue.' There are several input fields: 'Enable DDNS' (checkbox, unchecked), 'Server Address' (text box with 'www.dlinkddns.com'), 'Host Name' (text box with '<< www.dlinkddns.com'), 'User Name' (text box), 'Password' (text box), 'Verify Password' (text box), and 'Timeout' (text box with '24' and '(hours)'). At the bottom right, there are three buttons: 'Back', 'Next', and 'Cancel'.

Step 3:

Enter a name for your camera and click **Next** to continue.

The screenshot shows the 'Step 3: Assign a Name to the Camera' screen in the D-Link Setup Wizard. The left sidebar contains 'Setup Wizard', 'Settings', 'Advanced Setup', and 'Camera Info'. The main content area has a heading 'Step 3: Assign a Name to the Camera' and a sub-heading 'Step 3: Assign a Name to the Camera'. Below this, there is a paragraph: 'We recommend that you give your Camera a unique name to easily identify it on your network.' There is one input field: 'IP camera Name' (text box with 'DCS-4802E'). At the bottom right, there are three buttons: 'Back', 'Next', and 'Cancel'.

Step 4:

Set the correct time to ensure that all events will be triggered as scheduled. Click **Next** to continue.

The screenshot shows the 'Step 4: Set your Camera's Time Zone' screen in the D-Link Setup Wizard. The left sidebar contains 'Setup Wizard', 'Settings', 'Advanced Setup', and 'Camera Info'. The main content area has a heading 'Step 4: Set your Camera's Time Zone' and a sub-heading 'Step 4: Set your Camera's Time Zone'. Below this, there is a paragraph: 'Please set the correct time zone for your Camera to ensure that all events are triggered, captured, and scheduled correctly.' There are two input fields: 'Time Zone' (dropdown menu with '(GMT) Coordinated Universal Time') and 'Enable Daylight Saving' (checkbox, unchecked). At the bottom right, there are three buttons: 'Back', 'Next', and 'Cancel'.

Step 5:

Confirm the settings are correct and click **Apply** to save them. The settings will be saved to the DCS-4802E and the camera will restart.

The screenshot shows the 'Step 5: Setup Complete' screen in the D-Link Setup Wizard. The left sidebar contains 'Setup Wizard', 'Settings', 'Advanced Setup', and 'Camera Info'. The main content area has a heading 'Step 5: Setup Complete' and a sub-heading 'Step 5: Setup Complete'. Below this, there is a paragraph: 'The summary below shows the options you have selected. Click Finish to apply these options or click Back if you wish to make changes. Please make a note of these settings to ensure you can access your Camera in the future.' There is a table with the following data:

IP Address	DHCP
IP camera Name	DCS-4802E
Time Zone	(GMT) Coordinated Universal Time
DDNS	Disable
PPPoE	Disable

At the bottom right, there are three buttons: 'Back', 'Apply', and 'Cancel'.

Motion Detection Setup Wizard

This wizard will guide you through a step-by-step process to configure your camera's motion detection functions.

Click **Next** to continue.

Step 1

This step will allow you to enable or disable motion detection, specify the detection sensitivity, and define what parts of the camera's view to monitor for motion.

You may specify whether the camera should capture a snapshot or record a video clip when motion is detected.

Please refer to "**Motion Detection**" on page 52 for more information about how to configure motion detection.

Click **Next** to continue.

Step 2

This step allows you to enable motion detection based on a customized schedule. Specify the day and hours. You may also choose to always record whenever motion is detected.

Click **Next** to continue.

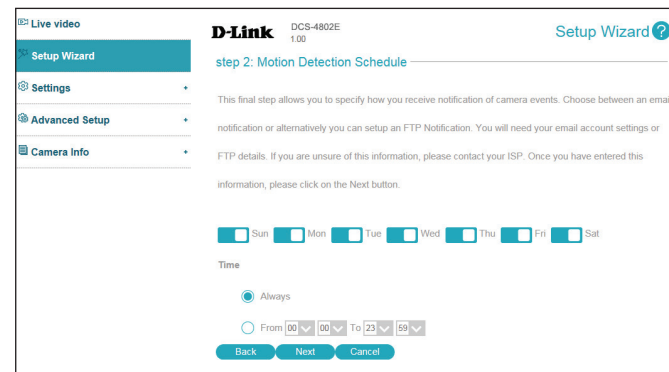
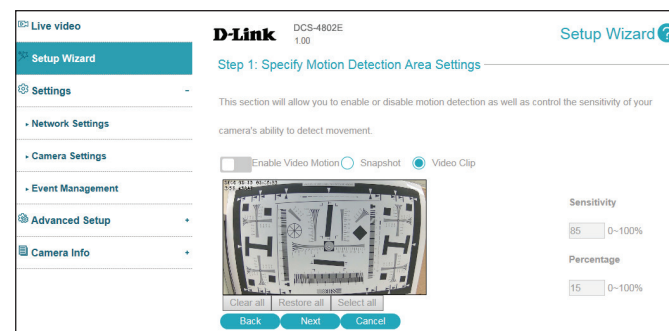
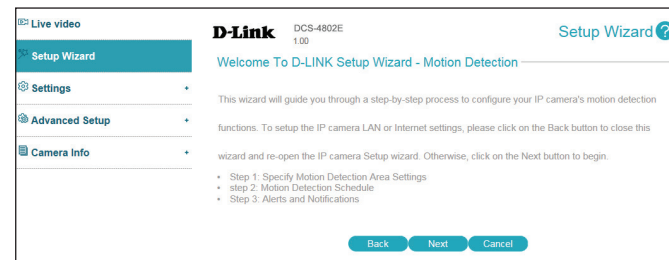

Step 3

This step allows you to specify where to send the snapshot/video clip/system log when motion is detected. Select **E-mail**, **FTP**, or **Network Storage** and enter the relevant information.

Click **Next** to continue.

Live video D-Link DCS-4802E 1.00 Setup Wizard ?

Setup Wizard

Settings

Advanced Setup

Camera Info

Step 3: Alerts and Notification

This final step allows you to specify how you receive notification of camera events. Choose between an email notification or alternatively you can setup an FTP Notification. You will need your email account settings or FTP details. If you are unsure of this information, please contact your ISP. Once you have entered this information, please click on the Next button.

Do not notify me

Email

Sender email address

Recipient email address

Server address

D-Link DCS-4802E 1.00 Setup Wizard ?

User name

Password

Port 25

This server requires a secure connection (StartTLS)

FTP

Server address

Port 21

User name

Password

Remote folder name

Back Next Cancel

Step 4

You have completed the Motion Detection Wizard.

Please verify your settings and click **Apply** to save them.

Please wait a few moments while the camera saves your settings and restarts.

Live video D-Link DCS-4802E 1.00 Setup Wizard ?

Setup Wizard

Settings

Advanced Setup

Camera Info

Step 4: Setup Complete

You have completed your IP camera setup. Please click the Back button if you want to review or modify your settings or click on the Apply button to save and apply your settings.

Motion Detection : Disable

EVENT : Video Clip

Schedule Day : Sun ,Mon ,Tue ,Wed ,Thu ,Fri ,Sat ,

Schedule Time : Always

Alerts and Notification : Do not notify me

Back Apply Cancel

Settings

Network Settings

LAN Settings

Use this section to configure the network connections for your camera. All relevant information must be entered accurately. Please note that PPPoE must be disabled to make any changes on this page; refer to **"PPPoE" on page 32** for more details. After making any changes, click the **Save** button to save your changes.

DHCP: Select this connection if you have a DHCP server running on your network and would like your camera to obtain an IP address automatically.

Static IP Client: If you choose DHCP, you do not need to fill out the IP address settings. You may obtain a static or fixed IP address and other network information from your network administrator for your camera. A static IP address may simplify access to your camera in the future.

IP address: Enter the fixed IP address in this field.

Subnet mask: This number is used to determine if the destination is in the same subnet. The default value is 255.255.255.0.

Default router: Enter the router/gateway used to forward frames to destinations in a different subnet. Invalid router/gateway settings may cause the failure of transmissions to a different subnet.

Primary DNS: Enter the primary domain name server for translating domain names to IP addresses.

Secondary DNS: Enter the secondary domain name server for translating domain names to IP addresses.

The screenshot displays the LAN Settings interface for a D-Link DCS-4802E camera. The 'DHCP' option is selected, and the 'Static IP Client' option is unselected. The following fields are populated with values:

Field	Value
IP address	192.168.1.101
Subnet mask	255.255.255.0
Default router	192.168.1.1
Primary DNS	192.168.168.250
Secondary DNS	192.168.168.201

A 'Save' button is located at the bottom right of the settings area.

IPv6

Use this section to configure your camera's IPv6 settings. After making any changes, click the **Save** button to save your changes.

Enable IPv6: Enable the IPv6 setting to use the IPv6 protocol.

Manually Setup The IP Address: Enabling the option allows you to manually set up the address, specify an optional IP address, specify an optional router address, and an optional primary DNS address. You can click the **Information** button to see the IPv6 address lists for the host, gateway, and DNS server.

PPPoE

Use this section to configure your camera's PPPoE settings. After making any changes, click the **Save** button to save your changes.

Enable PPPoE: Enable this setting if your network uses PPPoE.

User Name / Password: Enter the username and password for your PPPoE account. Re-enter your password in the Confirm Password field. You may obtain this information from your ISP.

PPPoE Status: This shows your current PPPoE connection status.

HTTP and HTTPS

Use this section to configure the HTTP and HTTPS access settings for your camera. After making any changes, click the **Save** button to save your changes.

HTTP

HTTP Port: The default port number is 80.

Access Name for Stream 1~2: The default name is **video#.mjpeg**, where # is the number of the stream.

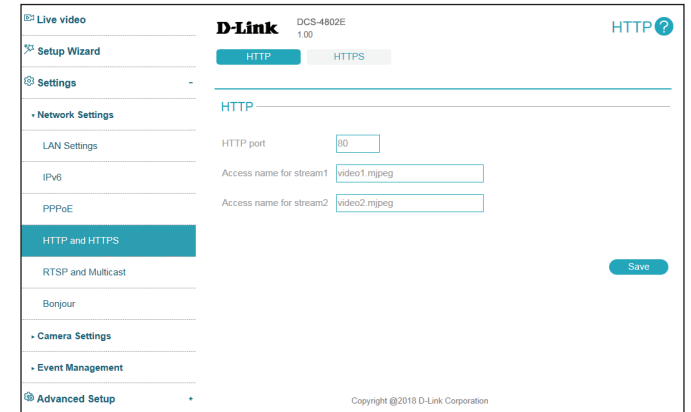

HTTPS

HTTPS Port: You may use a PC with a secure browser to connect to the HTTPS port of the camera. The default port number is 443.

Enable HTTPS Secure Connection: Enable the HTTPS service.

Create Certificate Method: Choose the way the certificate should be created. Three options are available:

- Create a self-signed certificate automatically
- Create a self-signed certificate manually
- Create a certificate request and install

Status: Displays the status of the certificate.

Note: The certificate cannot be removed while the HTTPS is still enabled. To remove the certificate, you must first uncheck **HTTPS secure connection**.

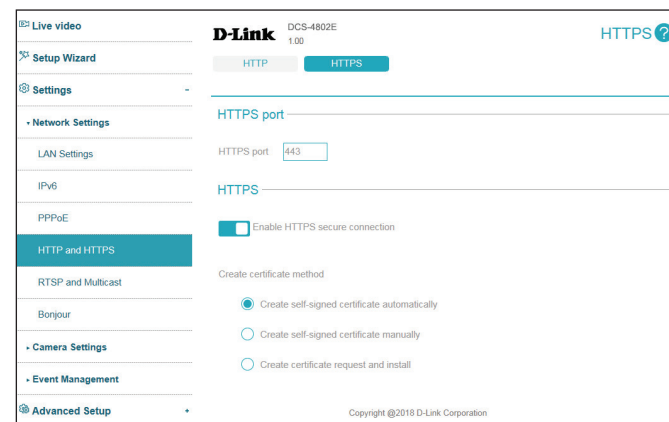

RTSP and Multicast

Use this section to configure your camera's RTSP and multicast stream settings. After making any changes, click the **Save** button to save your changes.

RTSP

Authentication: Choose to enable or disable RTSP digest encryption. Digest encryption uses MD5 hashes.

RTSP Port: The port number that you use for RTSP streaming to mobile devices, such as mobile phones or tablets. The default port number is 554.

Access Name for Stream 1/2: You may specify the address of a particular stream. For instance, live1.sdp can be accessed at rtsp://x.x.x.x/live1.sdp where the x.x.x.x represents the ip address of your camera.

Multicast

Multicast for Stream 1/2: The DCS-4802E allows you to multicast each of the available streams via a group address and specify the TTL value for each stream. Enter the port and TTL settings you wish to use if you do not want to use the defaults.

The screenshot shows the 'RTSP' configuration page for a D-Link DCS-4802E camera. The page has a sidebar with navigation options: Live video, Setup Wizard, Settings, Network Settings, LAN Settings, IPv6, PPPoE, HTTP and HTTPS, RTSP and Multicast (selected), Bonjour, Camera Settings, Event Management, and Advanced Setup. The main content area is titled 'RTSP' and includes the following fields:

- Authentication: A dropdown menu set to 'Digest'.
- RTSP port: A text input field containing '554'.
- Access name for stream1: A text input field containing 'live1.sdp'.
- Access name for stream2: A text input field containing 'live2.sdp'.

A 'Save' button is located at the bottom right of the configuration area. The footer indicates 'Copyright ©2018 D-Link Corporation'.

The screenshot shows the 'Multicast' configuration page for a D-Link DCS-4802E camera. The page has a sidebar with navigation options: Live video, Setup Wizard, Settings, Network Settings, LAN Settings, IPv6, PPPoE, HTTP and HTTPS, RTSP and Multicast, Bonjour, Camera Settings, Event Management, and Advanced Setup. The main content area is titled 'Multicast' and includes the following fields:

- Enable multicast for stream 1: A toggle switch that is currently turned off.
- Multicast group address: A text input field containing '239.1.1.1'.
- Multicast video port: A text input field containing '8550'.
- Multicast RTCP video port: A text input field containing '8551'.
- Multicast TTL [1~255]: A text input field containing '64'.
- Enable multicast for stream 2: A toggle switch that is currently turned off.
- Multicast group address: A text input field containing '239.1.1.2'.
- Multicast video port: A text input field containing '8554'.

The footer indicates 'Copyright ©2018 D-Link Corporation'.

This image shows a detailed view of the multicast configuration for two streams. The settings are as follows:

- Multicast group address: 239.1.1.1
- Multicast video port: 8550
- Multicast RTCP video port: 8551
- Multicast TTL [1~255]: 64
- Enable multicast for stream 2:
- Multicast group address: 239.1.1.2
- Multicast video port: 8554
- Multicast RTCP video port: 8555
- Multicast TTL [1~255]: 64

Bonjour

Use this section to enable Bonjour, which allows your camera to be accessed more easily on your network. After making any changes, click the **Save** button to save your changes.

Bonjour: Enable this to enable Bonjour support.

Bonjour Name: Enter a name to identify this camera on Bonjour.

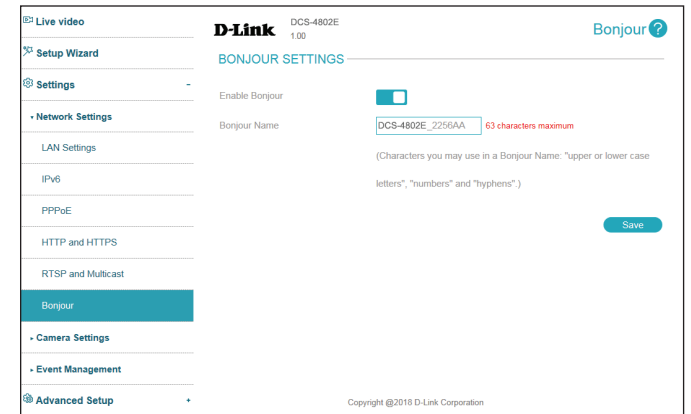

Camera Settings

Camera Settings

Use this section to configure the device name and LED behavior for your camera. After making any changes, click the **Save** button to save your changes.

IP Camera Name: Create a unique name for your camera that will be added to the file name prefix when creating a snapshot or a video clip.

LED: You may specify whether or not to illuminate the status LED on the camera.
For security reasons, this setting is set to **Off** by default.

The screenshot displays the D-Link camera configuration web interface. On the left is a navigation sidebar with a teal header and menu items: Live video, Setup Wizard, Settings, Network Settings, Camera Settings (highlighted), Image Settings, Video Stream, Event Management, Advanced Setup, and Camera Info. The main panel shows the 'Camera Settings' page for a DCS-4802E camera. It includes a title bar with 'D-Link DCS-4802E 1.00' and 'Camera Settings ?'. The 'IP Camera Name' field contains 'DCS-4802E' with a '32 characters maximum' warning. The 'LED' section has two radio buttons: 'On' (unselected) and 'Off' (selected). A teal 'Save' button is positioned at the bottom right. The footer contains the text 'Copyright ©2018 D-Link Corporation'.

Image Settings

In this section, you may configure the video image settings for your camera. All changes in the Image Settings section will be made immediately. For the other sections, after making any changes, click the **Save** button to save your changes.

Image

Mirror: This will mirror the image horizontally.

Flip: This will flip the image vertically. When turning Flip on, you may want to consider turning **Mirror** on as well.

Anti-Flicker: Select the frequency used by your power lines to avoid interference or distortion.

White Balance: Use the drop-down box to change white balance settings to help balance colors for different environments. You can choose from **Auto, Outdoor, Indoor**.

Exposure Mode: Changes the exposure mode. Use the drop-down box to set the camera for **Indoor, Outdoor, or Night** environments, or to **Moving** to capture moving objects. You can also create 3 different custom exposure modes. Max Gain will limit the brightness of the exposure.

Denoise: This setting controls the amount of noise reduction that will be applied to the picture.

The screenshot displays the D-Link DCS-4802E web interface. The top navigation bar includes 'Live video', 'D-Link DCS-4802E 1.00', and 'Image' with a help icon. Below the navigation bar, there are tabs for 'Image', 'ICR and IR', 'OSD', and 'Privacy Mask'. The main content area is divided into two sections: 'LIVE VIDEO' and 'IMAGE SETTINGS'. The 'LIVE VIDEO' section shows a live camera feed of a circuit board. The 'IMAGE SETTINGS' section contains the following controls:

- Mirror: On Off
- Flip: On Off
- Anti Flicker: 60 Hz 50 Hz
- White Balance: Auto (dropdown)
- Exposure Mode: Auto (dropdown) Max Gain: 36 dB (dropdown)
- Denoise: 0 (dropdown)
- Brightness: 7 (dropdown)
- Contrast: 5 (dropdown)
- Saturation: 4 (dropdown)
- Sharpness: 4 (dropdown)
- White Balance: Auto (dropdown)
- Exposure Mode: Auto (dropdown) Max Gain: 36 dB (dropdown)
- Denoise: 0 (dropdown)
- Brightness: 7 (dropdown)
- Contrast: 5 (dropdown)
- Saturation: 4 (dropdown)
- Sharpness: 4 (dropdown)
- WDR Level: 0 (dropdown)
- 3D filter: ON OFF

A 'Reset Default' button is located at the bottom of the 'IMAGE SETTINGS' section.

Brightness: Adjust this setting to compensate for backlit subjects.

Contrast: Adjust this setting to alter the color intensity/strength.

Saturation: This setting controls the amount of coloration, from grayscale to fully saturated.

Sharpness: Specify a value to determine how much sharpening to apply to the image.

WDR Level: Wide Dynamic Range (WDR) helps improve exposure, making it easier to see objects in very bright or dark areas of the camera's image. Specify a value to determine how much WDR adjustment to apply to the image, or select **None**.

3D Filter: This reduces the amount of image noise when viewing a low-light environment.

Reset Default: Click this button to reset the image to factory default settings.

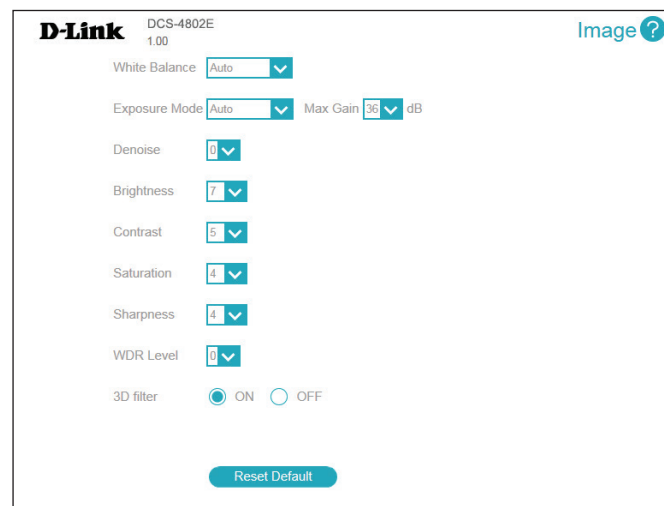

ICR & IR

Use this section to configure the IR LED and IR-cut removable filter behavior for your camera.

ICR

Automatic: The Day/Night mode is set automatically. Generally, the camera uses Day mode and switches to Night mode when needed. Use the **Sensitivity** drop-down box to select when the camera should switch to Night mode. The text to the right of the drop-down box shows what the current lighting conditions are like, and you can refresh this information by clicking the **Refresh** button.

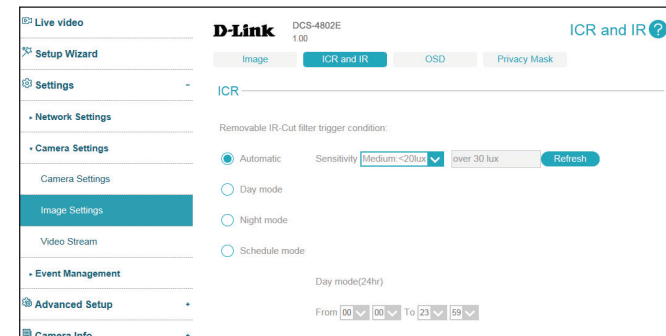

Day Mode: Day mode enables the IR Cut Filter and turns off the IR LEDs.

Night Mode: Night mode disables the IR Cut Filter and turns on the IR LEDs.

Schedule Mode: Set Day/Night mode using the schedule set in the drop-down boxes. The camera will enter Day mode at the starting time and return to Night mode at the ending time. Activate the **Disable IR LED** to set Day mode for the set times.

IR Light

IR Light Control: The camera can enable or disable the IR (infrared) light according to your preferences. This setting provides additional controls depending on your specific application.

Off: Disables the IR light.

On: Enables the IR light.

Sync With ICR: The IR light will turn on when the ICR filter is disabled (night mode).

Schedule: The IR light will turn on or off according to the schedule that you specify below.

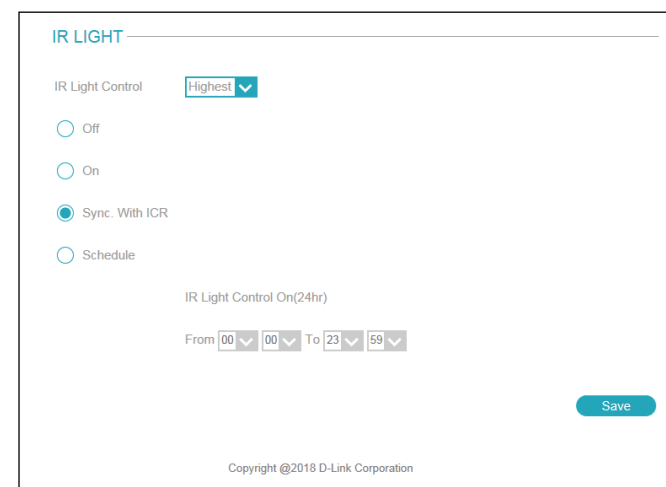

OSD Settings

OSD: Select this option to enable the On-Screen Display feature for your camera. This will allow some information to appear in the top-left corner of the camera's video.

Label: Enter a label for the camera, which will be shown on the OSD when it is enabled.

Privacy Mask

Enable Privacy Mask Setting: The Privacy Mask setting allows you to click and drag the mouse cursor over the camera image to draw maximum 3 rectangular areas which will be blocked/excluded from recordings and snapshots. Click the Save button to save your changes.

Restore All: Clear all privacy mask areas.

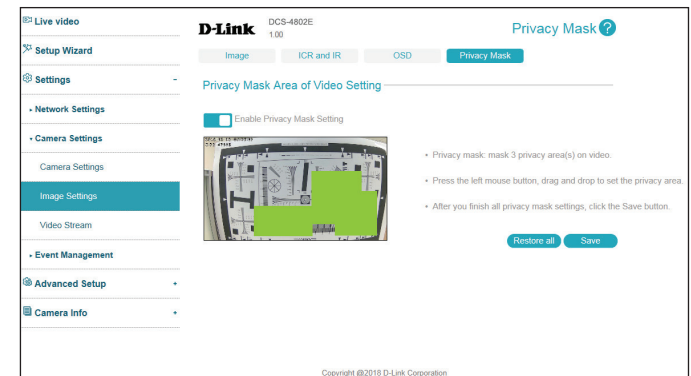
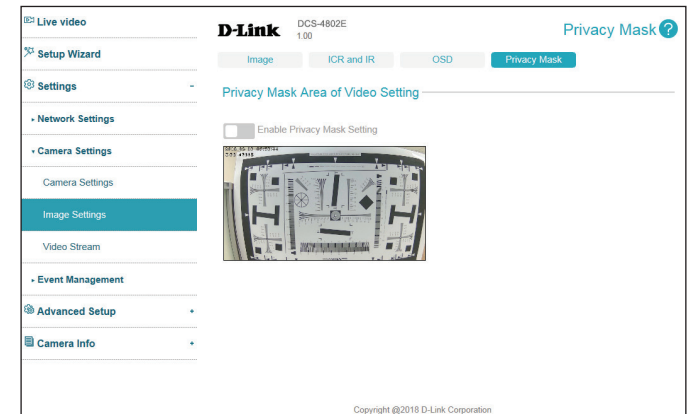
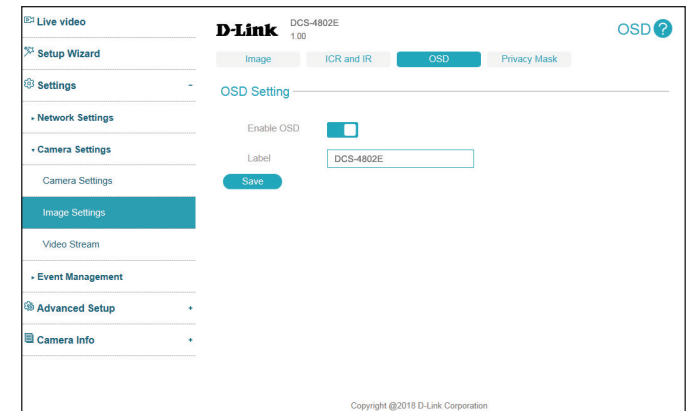

Video Stream

You may configure up to 2 video profiles with different settings for your camera. This allows you to set different settings for recording video and for viewing your video remotely, for example. After making any changes, click the **Save** button to save your changes.

Aspect Ratio: Set whether you want your camera to use a 4:3 or 16:9 aspect ratio for its video. When changing this setting, you will need to redo setup for motion detection, privacy masks, and preset points.

Mode: Set the video codec to be used to **H.264**, **H.265**, or **JPEG**.

Frame Size: Select what frame size to use. Frame size determines the total capture resolution. Larger frame sizes provide more detail, but will require more bandwidth.

Maximum Frame Rate: You can set the maximum frame rate. A higher frame rate provides smoother motion for videos and requires more bandwidth. Lower frame rates will result in stuttering motion and require less bandwidth.

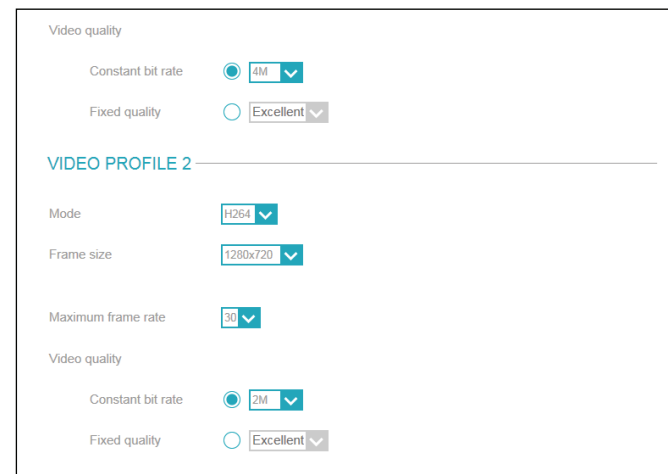
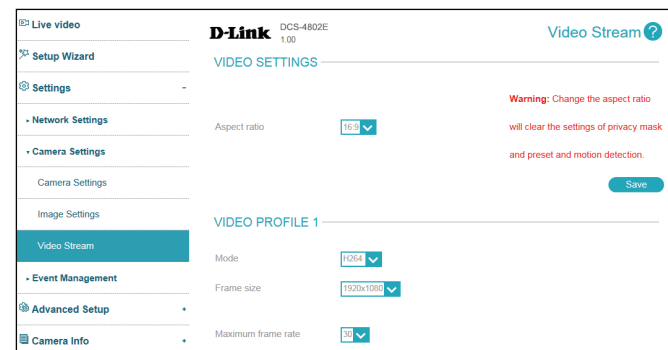

Constant Bit Rate: You can set the bit rate to use for this video profile.

Fixed Quality: Select the image quality level for the camera to try to maintain. Higher quality levels will result in increased bit rates and use more bandwidth.

The screenshot shows the configuration page for the D-Link DCS-4802E camera's video stream. The page is titled "D-Link DCS-4802E" and "Video Stream". It features two sections for video quality settings. The top section has a "Constant bit rate" option selected with a radio button and a dropdown menu set to "4M", and a "Fixed quality" option with a radio button and a dropdown menu set to "Excellent". The bottom section, titled "VIDEO PROFILE 2", has a "Mode" dropdown set to "H264", a "Frame size" dropdown set to "1280x720", and a "Maximum frame rate" dropdown set to "30". Under "Video quality", the "Constant bit rate" option is selected with a radio button and a dropdown menu set to "2M", and the "Fixed quality" option has a radio button and a dropdown menu set to "Excellent". At the bottom right, there are "Save" and "Cancel" buttons. The footer of the page reads "Copyright ©2018 D-Link Corporation".

Event Management Event Management

The DCS-4802E has a comprehensive event management system that lets you configure the camera to perform certain actions when an event occurs. For example, when motion is detected, you can have snapshots sent to an e-mail address. You can also configure the camera to take regular video recordings according to a schedule you define. Detailed information for the following steps can be found in the following pages.

Step 1: Select your destination Server and Media type

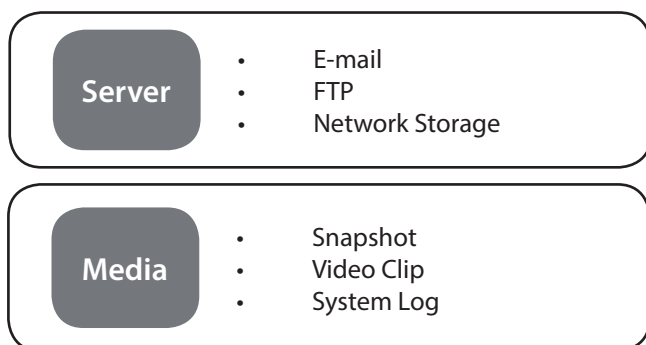

Step 2: Select your Trigger event and Action

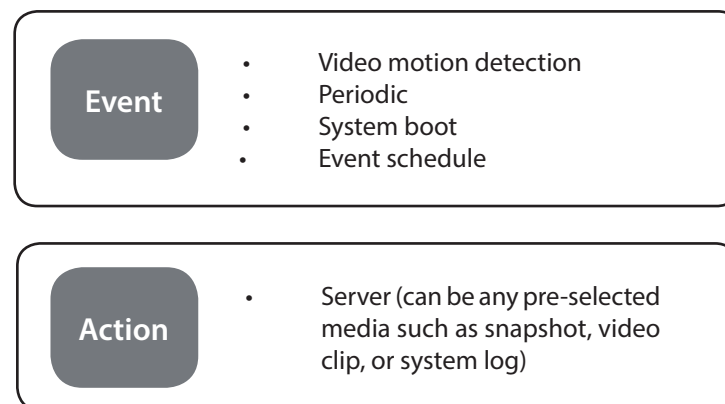

When an event is triggered:

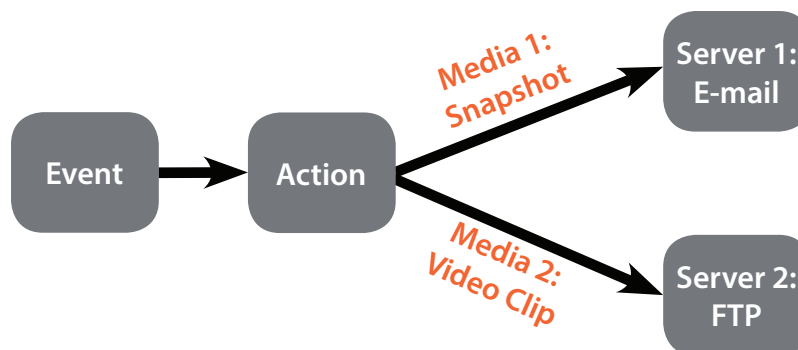

Event Management

The Event Setup page includes 4 different sections:

- Server
- Media
- Event Settings
- Recording

1. To add a new server, media, event, or recording item, click **Add**. A screen will appear and allow you to update the fields accordingly.
2. To delete the selected item from the server, media, event, or recording drop-down menus, click the **Delete** button next to it.
3. Click on the name of an item to edit it.

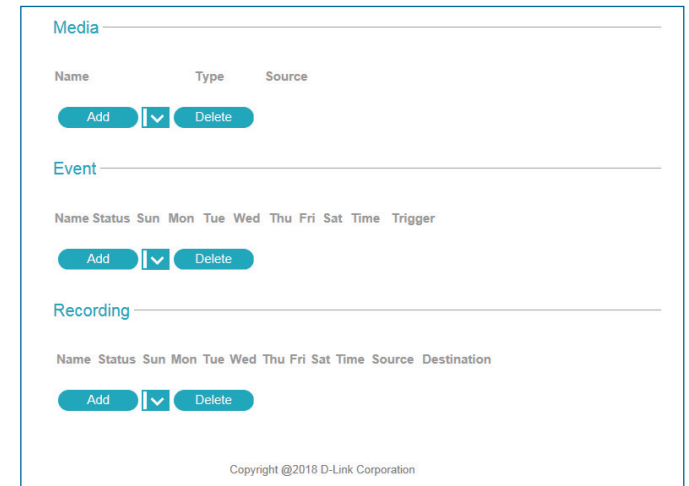
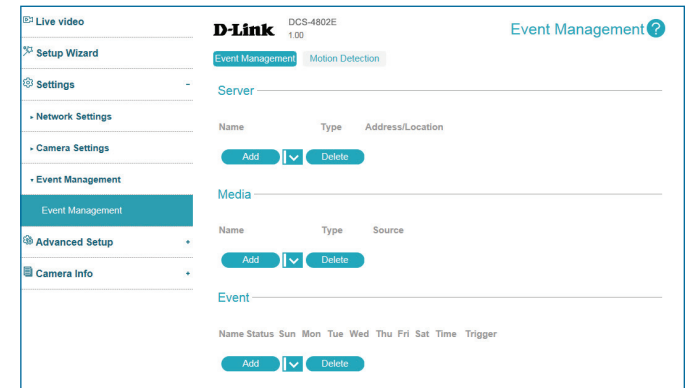

Server

You can configure a server for each server type, and up to 5 FTP servers. After making any changes, click the **Save** button to save your changes.

Server Name: Enter the name for the server.

Email: If you want to use an e-mail address for your server, select this and enter the settings for your target e-mail account.

FTP: If you want to use an FTP server for your server, select this and enter the settings for your target FTP server.

Network Storage: If you want to use a network storage device for your server, select this and enter its settings here.

The screenshot displays the 'Event Management' configuration interface for a D-Link DCS-4802E device. The left sidebar shows a navigation menu with 'Event Management' selected. The main content area is titled 'Server Type' and offers three options: Email, FTP, and Network storage. The 'Email' option is currently selected, indicated by a radio button. Below this selection, there are several input fields: 'Server Name', 'Sender email address', 'Recipient email address', 'Server address', 'User name', and 'Password'. A checkbox labeled 'This server requires a secure connection (StartTLS)' is present but unchecked. The 'FTP' section is also visible, with fields for 'Server address', 'Port' (set to 21), 'Login Type' (set to 'Username & Password'), 'User name', 'Password', and 'Remote folder name'. A 'Passive mode' checkbox is also present and unchecked. The 'Network storage' section is partially visible at the bottom, with fields for 'Network storage location', 'Workgroup', 'User name', 'Password', and 'Primary WINS server'. At the bottom right of the configuration area, there are three buttons: 'Test', 'Save', and 'Cancel'.

Media

There are three types of media: **Snapshot**, **Video Clip**, and **System Log**. You can make a media entry for each type. After making any changes, click the **Save** button to save your changes.

Media Name: Enter a unique name for media type you want to create.

Snapshot: Select this option to set the media type to snapshots.

Source: Set the video profile to use as the media source. Refer to "**Video Stream**" on page 42 for more information on video profiles.

Send pre-event image(s): Set the number of pre-event images to take. Pre-event images are images taken before the main event snapshot is taken.

Send post-event image(s): Set the number of post-event images to take. Post-event images are images taken after the main event snapshot is taken.

For example:

If both the Send pre-event images and Send post-event images are set to 4, a total of 9 images are generated after a trigger is activated.

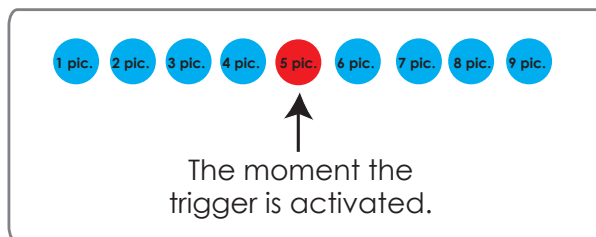

The screenshot shows the D-Link DCS-4802E Event Management configuration page. The 'Media Type' is set to 'Snapshot'. The 'Source' is set to 'profile 1'. The 'Send' fields for pre-event images (0-4) and post-event images (0-7) are both set to 1. The 'File Name Prefix' field is empty. The 'Add date and time suffix to file name' checkbox is unchecked. The 'Video Clip' and 'System log' options are also visible but not selected. A 'Save' button is located at the bottom right of the configuration area.

File name prefix: The prefix name will be added to the file name.

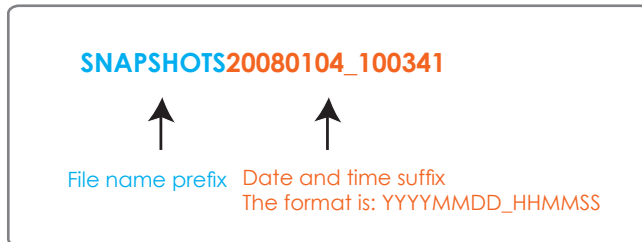

Add date and time suffix to file name: Enable this to add the date and time the snapshot was recorded as a file name suffix.

Video clip: Select this option to set the media type to video clips.

Source: Set the video profile to use as the media source. Refer to **"Video Stream" on page 42** for more information on video profiles.

Pre-event recording: This sets how many seconds to record before the main event video clip starts.

Maximum duration: Set the maximum length of video to record for your video clips.

Maximum file size: Set the maximum file size to record for your video clips.

File Name Prefix: This is the prefix that will be added to the filename of saved video clips.

System log: Select this option to set the media type to system logs. This will save the event to the camera system log, but will not record any snapshots or video.

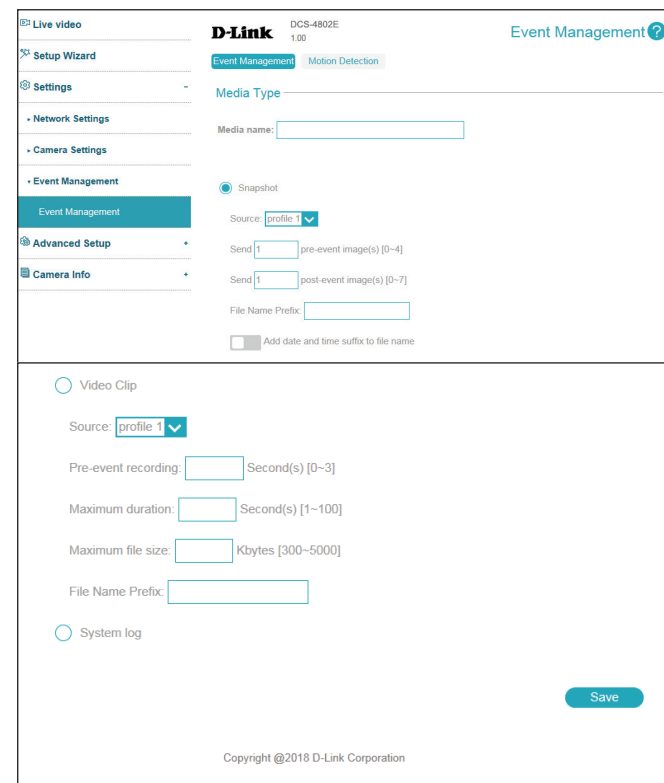

Event

Create and schedule up to three events with their own settings here. After making any changes, click the **Save** button to save your changes.

Event name: Enter a name for the event.

Enable this event: Toggle this to activate this event.

Priority: Set the priority for this event. Events with higher priority will be executed first.

Delay for: Specify the delay time before allowing this event to be triggered again. This is used for both motion detection events and event triggers.

Trigger

Video Motion Detection: Selecting this will trigger the event when motion is detected during live video monitoring. Make sure you have enabled motion detection and specified what part of the image to monitor for motion. For more details, refer to **"Motion Detection" on page 52**.

Periodic: Selecting this will trigger the event in specified intervals. The trigger interval unit is in minutes.

System Boot: Selecting this will trigger an event when the system boots up.

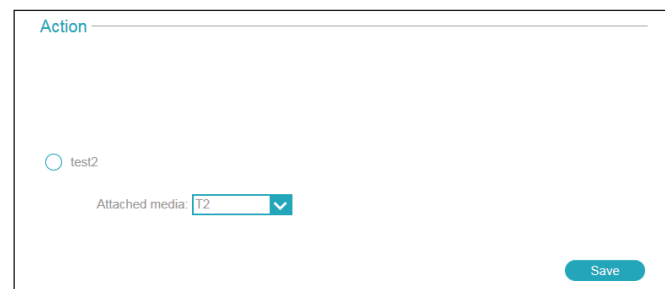
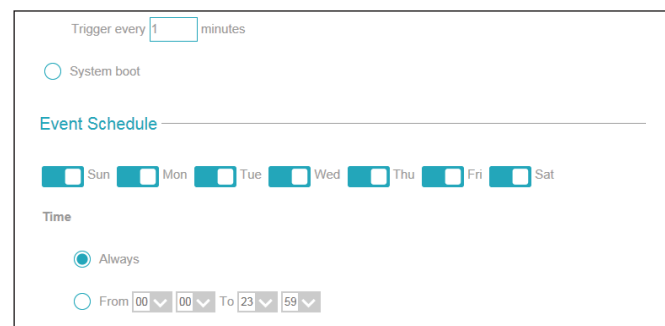
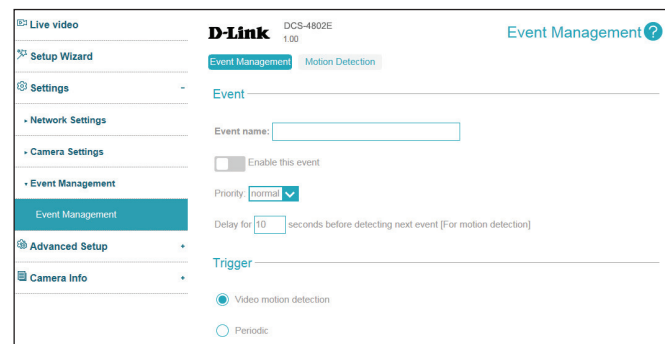

Event Schedule

Specify when you want to monitor for this event. Select which days to monitor for this event, then select **Always** or enter the time interval to monitor for the specified event.

Action: Select the actions you want the camera to take when the event happens. Select the Server to use, then choose the Media you want to save to it. Please note that you need to set up your Server and Media entries first.

The screenshot shows the 'Event Settings' page for a D-Link DCS-4802E camera. The page is divided into several sections:

- Event (Name):** A text input field for naming the event.
- Enable This Event:** A checkbox to toggle the event on or off.
- Priority:** A dropdown menu currently set to 'Normal'.
- Delay for:** A text input field set to '10' seconds before detecting the next event.
- Trigger:** A section with radio buttons for:
 - Video Motion Detection
 - Periodic (with a 'Trigger Every' field set to '1' minutes)
 - Camera Boot
 - Network Lost
 - Tamper Detection
- Event Schedule:** A section with a row of day selection buttons (Sun, Mon, Tue, Wed, Thu, Fri, Sat) and a 'Time' section with:
 - Always
 - From [00:00] To [23:59]
- Action:** A section with:
 - Server 1
 - Attached media: [None]

A 'Save' button is located at the bottom right of the form.

Recording

Here you can configure and schedule the recording settings. After making any changes, click the **Save** button to save your changes.

Recording Entry Name: Enter a name for the recording.

Enable This Recording: Select this to enable the recording function.

Priority: Set the priority for this entry. An entry with a higher priority value will be executed first.

Source: Select the video profile to use as the recording source.

Recording Schedule

Use the checkboxes to set which days to record video on. Select **Always** to record for the entire day, or select **From** and select what period of time you want to record using the drop-down boxes.

Destination: Select a storage destination that was configured in Server to send recordings there.

Size of Each File for Recording: If this is selected, files will be split based on the file size you specify.

Time of Each File for Recording: If this is selected, files will be based on the maximum length you specify.

File Name Prefix: The prefix name will be added to the beginning of the file name of the recording file(s).

Motion Detection

Motion detection enables the camera to monitor the video feed for movement. Here, you can adjust the sensitivity settings that determine whether motion is detected by the camera or not. After making any changes, click the **Save** button to save your changes.

Enable Video Motion: Enable this to enable the motion detection feature of your camera. Please note that you must create at least one motion detection box for the camera to detect motion.

Sensitivity: Set how sensitive motion detection will be from 0% to 100%. A low sensitivity means that there must be large changes between two images in order to detect motion, and a high sensitivity means that even small changes will cause motion to be detected.

Low sensitivities may be useful when monitoring an area that has flickering lights or a window to the outside in view. High sensitivities may be useful when monitoring an area that rarely changes, such as a storeroom or warehouse.

Percentage: Set how much of the area being monitored for motion must change for motion to be detected. A low percentage means that only part of the area being monitored has to change to detect motion, and a high percentage means that most of the area needs to change to detect motion.

Low percentages can be useful when monitoring an area such as a large room, and high percentages can be useful when you are only monitoring a specific part of the camera's view, such as a doorway.



Advanced Setup

Advanced UPnP

Enabling Video Motion will allow your camera to use UPnP to automatically set up port forwarding on your router. After making any changes, click the **Save** button to save your changes.

Enable UPnP Presentation: Enabling this setting allows your camera to be configured as a UPnP device on your network.

Enable UPnP Port Forwarding: Enabling this setting allows the camera to add port forwarding entries into the router automatically on a UPnP capable network.

Forwarding Port: If UPnP Port Forwarding is enabled, you can set which port to use for forwarding.

Forwarding Status: If UPnP Port Forwarding is enabled, this will show the UPnP Port Forwarding status.

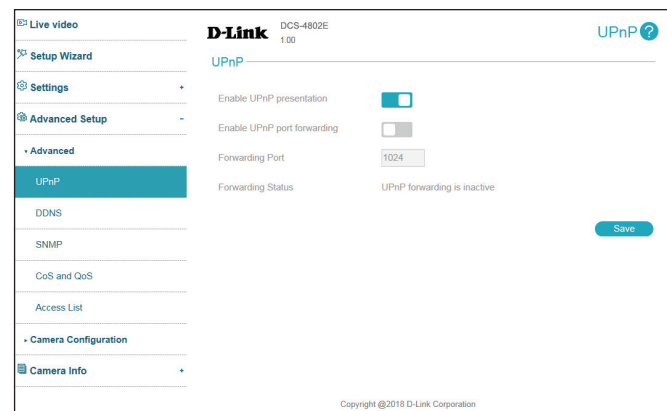

DDNS

DDNS allows you to compensate for changing IP addresses by having a URL that automatically points to the current IP address of your camera. To do this, you will need to have an account with one of the DDNS services listed in the drop-down box on this page. After making any changes, click the **Save** button to save your changes.

DDNS: Check this box to enable the DDNS function.

Server Address: Enter your DDNS server address, or select a service from the drop-down menu.

Host Name: Enter the host name of the DDNS service.

User Name: Enter the username or e-mail address used to connect to the DDNS service.

Password: Enter the password used to connect to the DDNS service.

Verify Password: Enter your DDNS service password again.

Timeout: You can set up how often the camera notifies the DDNS service of its current global IP address by entering a whole number in hours.

Status: This shows the current status of your DDNS updates.

The screenshot displays the 'DYNAMIC DNS SETTING' configuration page for a D-Link DCS-4802E camera. The interface includes a sidebar on the left with various configuration categories. The main area is titled 'DYNAMIC DNS SETTING' and contains the following fields and controls:

- Enable DDNS:** A toggle switch that is currently turned on.
- Server Address:** A dropdown menu showing 'www.dlinkddns.com'.
- Host Name:** An empty text input field.
- User Name:** An empty text input field.
- Password:** An empty text input field.
- Verify Password:** An empty text input field.
- Timeout:** A text input field containing '24' with '(hours)' next to it.
- Status:** A label indicating the current status is 'Active'.

A 'Save' button is located at the bottom right of the configuration area. The footer of the page reads 'Copyright ©2018 D-Link Corporation'.

SNMP

Here you can set the Simple Network Management Protocol (SNMP) settings for the camera, which allow for SNMP management of the camera. After making any changes, click the **Save** button to save your changes.

Enable SMNPv1, SNMPv2c: Enable this option to allow for SNMPv1 and SNMPv2c management of the camera.

Read/Write Community: Enter a name for the read/write community of your SNMP server.

Read Only Community: Enter a name for the read-only community of your SNMP server.

Enable SNMPv3: Enable this option to allow SNMPv3 management of the camera.

Read/Write Security Name: Enter a name for the read/write community of your read/write SNMP server.

Authentication Type: Enter the type of authentication used by your read/write SNMP server.

Authentication Password: Enter the authentication password used for your read/write SNMP server.

Encryption Password: Enter the encryption password used for your read/write SNMP server.

Read Only Security Name: Enter a name for the read-only community of your read-only SNMP server.

The screenshot displays the D-Link DCS-4802E web interface for SNMP Configuration. The interface is divided into two main sections: 'SNMP Configuration' and 'SNMPv3 Configuration'.

SNMP Configuration:

- Enable SNMPv1, SNMPv2c:
- Read/Write community:
- Read only community:
- Enable SNMPv3:
- Read/Write Security name:
- Authentication type:
- Authentication password:
- Encryption password:
- Read only security name:

SNMPv3 Configuration:

- Enable SNMPv3:
- Read/Write Security name:
- Authentication type:
- Authentication password:
- Encryption password:
- Read only security name:
- Authentication type:
- Authentication password:
- Encryption password:

A **Save** button is located at the bottom right of the configuration area. The footer indicates 'Copyright ©2018 D-Link Corporation'.

Authentication Type: Enter the type of authentication used by your read-only SNMP server.

Authentication Password: Enter the authentication password used for your read-only SNMP server.

Encryption Password: Enter the encryption password used for your read-only SNMP server.

The screenshot shows the configuration page for the D-Link DCS-4802E 1.00 device. The page is titled "D-Link DCS-4802E 1.00" and has an "SNMP ?" link in the top right corner. The configuration is organized into two sections. The first section, "Enable SNMPv3", has a toggle switch that is currently turned off. Below this, there are three fields: "Read/Write Security name" with the value "public", "Authentication type" with a dropdown menu set to "MD5", and "Authentication password" with an empty text box. The second section, "Read only security name", has a field with the value "private", "Authentication type" with a dropdown menu set to "MD5", "Authentication password" with an empty text box, and "Encryption password" with an empty text box. A blue "Save" button is located at the bottom right of the configuration area. At the bottom of the page, there is a copyright notice: "Copyright ©2018 D-Link Corporation".

CoS and QoS

Class of Service (CoS) and Quality of Service (QoS) allow you to prioritize surveillance traffic on your network to ensure that your cameras can stream video smoothly and remain accessible even when there is heavy traffic on your network. Your network must support CoS or QoS in order to use them. After making any changes, click the **Save** button to save your changes.

Enable CoS: Enabling the Class of Service setting implements a best-effort policy to prioritize traffic without making any bandwidth reservations.

To use CoS, enable it, enter the VLAN ID to use for the camera, and set the priority for your **Live Video**, **Live Audio**, **Event/Alarm**, and **Management** camera traffic.

Enable QoS: Enabling QoS allows you to specify a traffic priority policy to ensure a consistent Quality of Service during busy periods. If the network camera is connected to a router that itself implements QoS, the router's settings will override the QoS settings of the camera.

To use QoS, enable it and set the priority for your **Live Video**, **Live Audio**, **Event/Alarm**, and **Management** camera traffic.

The screenshot displays the configuration page for a D-Link DCS-4802E camera. The interface is divided into two main sections: CoS SETTINGS and QoS SETTINGS. The CoS SETTINGS section includes a toggle for CoS (currently disabled), a VLAN ID field (set to 1), and dropdown menus for Live video, Live audio, Event/Alarm, and Management (all set to 0). The QoS SETTINGS section includes a toggle for QoS (currently disabled) and dropdown menus for Live video, Live audio, Event/Alarm, and Management (all set to 0). A 'Save' button is located at the bottom right of the settings area. The footer of the page reads 'Copyright ©2018 D-Link Corporation'.

Access List

Here you can define which IP addresses are allowed to view your DCS-4802E. You can set up to 7 IP address ranges for both the allow and deny lists.

Allow List: The section lets you define what IP addresses have access rights to the camera.

Note: When adding entries to the Allow list, make sure the first entry includes the IP address of the computer or device you are using to access the camera. Otherwise, you may be blocked from accessing the camera after adding the entry to the Allow list.

Start IP Address: The starting IP address of the IP address range for the devices (such as a computer) that have permission to access the video of the camera.

End IP Address: The ending IP address of the IP address range for the devices (such as a computer) that have permission to access the video of the camera. Click **Add** to save your changes.

Delete Allow List: Select an entry to remove from the Allow List, then click **Delete**.

Deny List: The list of IP addresses that have no access rights to the camera.

Start IP Address: The starting IP address of the IP address range for the devices (such as a computer) that will be denied access to the camera.

End IP Address: The ending IP address of the IP address range for the devices (such as a computer) that will be denied access to the camera. Click **Add** to save your changes.

Delete Deny List: Select an entry to remove from the Deny List, then click **Delete**.

Note: All addresses in the Deny List will be denied access, even if they are also in the Allow List.

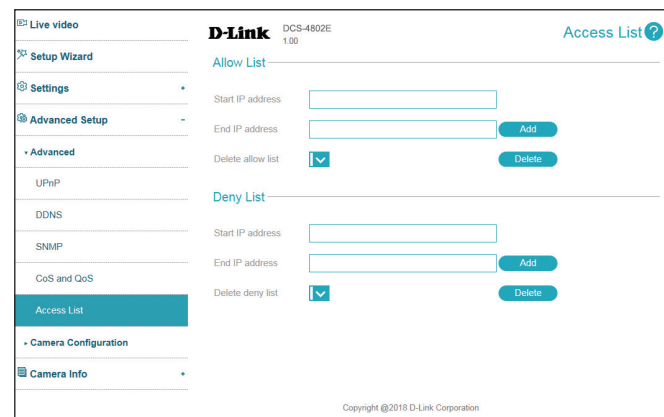

Camera Configuration

Save and Load Configuration

In this section, you may back up or restore the camera configuration.

Save To Local Hard Drive: You may save your current camera configuration as a file on your computer.

Load From Local Hard Drive: Locate a pre-saved configuration by clicking **Browse** and then restore the pre-defined settings to your camera by clicking **Load Configuration**.

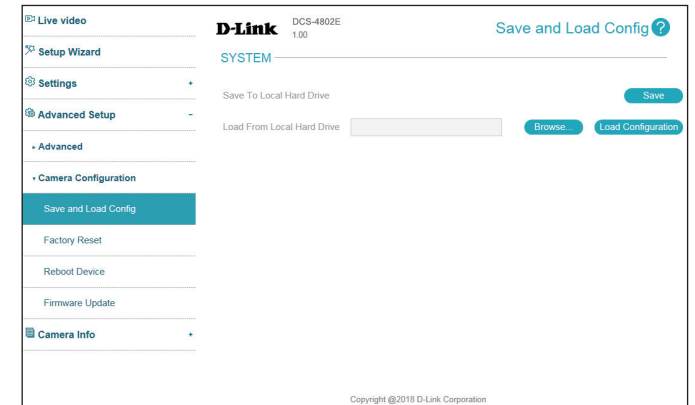

Factory Reset

Here you can reset the camera configuration back to the factory defaults.

Restore to Factory Default: You may reset your camera and restore the factory settings by clicking **Restore Factory Defaults**.

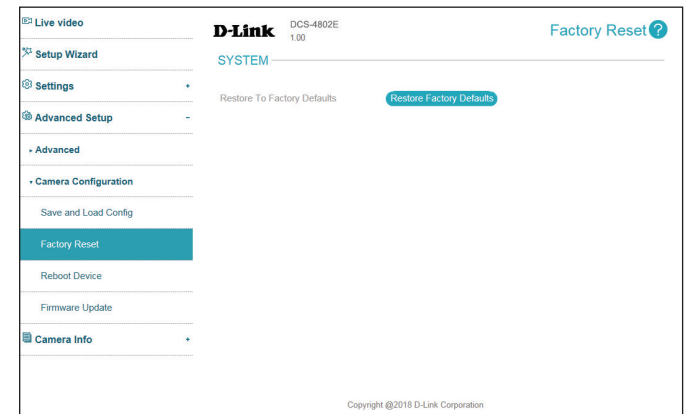

Reboot Device

Here you can reboot the camera, or set a schedule to reboot the camera automatically.

Reboot Device: This will restart your camera.

Schedule Reboot: If you want your camera to reboot on a regular schedule, enable this option, then select the days and time you want the camera to reboot on and click the **Save** button.

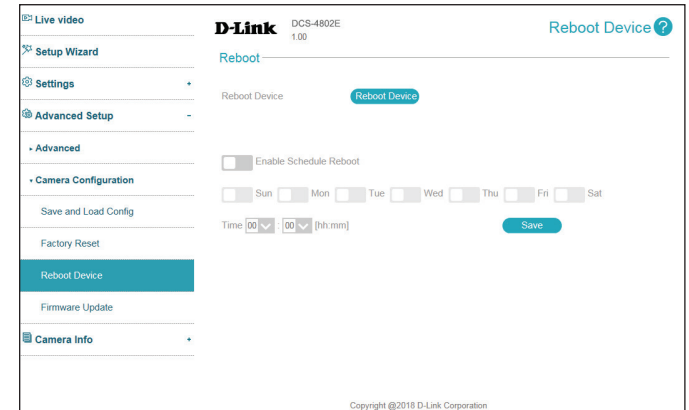

Firmware Update

Here you can update the camera's firmware. The current version of the firmware is shown next to the D-Link logo at the top of the page.

File Path: To update the firmware, select a firmware file to use from your hard drive by clicking **Browse...**, then click the **Upload** button.

Note: While the firmware is being updated, do not close the web browser or disconnect your camera's power or network connection until the update is complete.

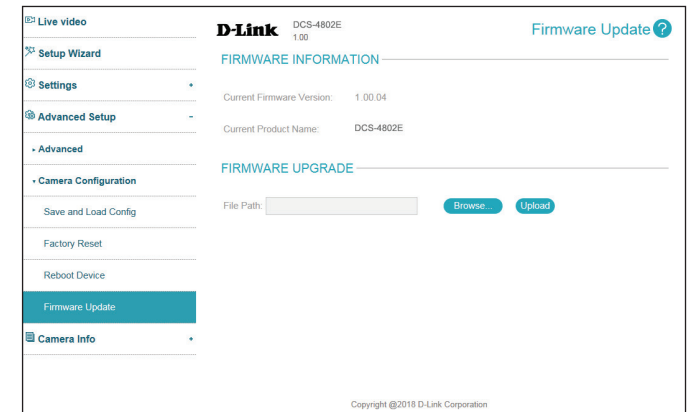

Camera Options

Camera Info

This page displays detailed information about your camera, the services running on your camera, and active video streams.

Live video

Setup Wizard

Settings +

Advanced Setup +

Camera Info -

DCS-4802E
1.00

Camera Info

Camera Info

Camera Info

▸ Time

▸ Administration Settings

System Log

INFORMATION

IP Camera Name	DCS-4802E
Time & Date	Fri Mar 9 1:52:3 2018
Firmware Version	1.00.04
Hardware Version	B
MAC Address	00:CA:83:71:00:02
IP Address	192.168.1.101
IP Subnet Mask	255.255.255.0
Default Gateway	192.168.1.1
Primary DNS	192.168.168.250
Secondary DNS	192.168.168.201

Copyright ©2018 D-Link Corporation

Time Time Settings

This section allows you set the time zone and Daylight Saving settings for your camera.

Time Zone: Select your time zone from the drop-down menu.

Daylight Saving: If your region uses Daylight Saving time, you can enable it here. Select Set date and time manually if you want to manually set the offset and the period of time that the Daylight Saving correction should be used.

Offset: Enter the offset that should be used when Daylight Saving is being used.

Start Time: Set the date and time that Daylight Saving should start.

End Time: Set the date and time that Daylight Saving should end.

The screenshot displays the 'Time Settings' interface for a D-Link DCS-4802E camera. The interface is divided into two main sections: 'TIME CONFIGURATION' and a detailed settings area.

TIME CONFIGURATION:

- Time Zone:** (GMT) Coordinated Universal Time (dropdown menu)
- Enable Daylight Saving:** Disabled (toggle switch)
- Auto Daylight Saving:** Disabled (radio button)
- Set date and time manually:** Enabled (radio button)
- Offset:** +02:00 (dropdown menu)

Set Date and Time:

	Month	Week	Day of week	Hour	Minutes
Start time	1	1	Sunday	0	0
End time	1	1	Sunday	0	0

Enable Daylight Saving: Disabled (toggle switch)

Auto Daylight Saving: Disabled (radio button)

Set date and time manually: Enabled (radio button)

Offset: +02:00 (dropdown menu)

Set Date and Time:

	Month	Week	Day of week	Hour	Minutes
Start time	1	1	Sunday	0	0
End time	1	1	Sunday	0	0

Save (button)

Copyright ©2018 D-Link Corporation

Auto Time Config

This section lets you set your camera's date and time automatically by using an NTP server.

NTP Server: Enable this option to set your camera's time using an NTP server, then select an NTP server to use from the drop-down box.

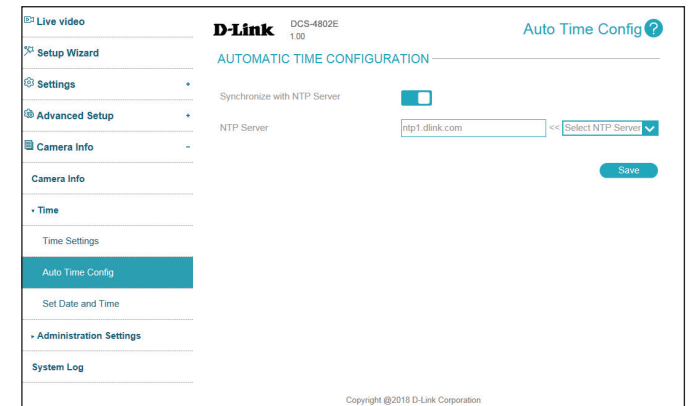

Set Date and Time

This section lets you manually set your camera's date and time. If you have **NTP Server** enabled in **Auto Time Config**, you will need to disable it before setting the date and time manually.

Set Date and Time Manually: Enable this option to manually set the time and date.

Copy Your PC's Time: This will synchronize the time information with your PC.

The screenshot shows the D-Link DCS-4802E web interface. The left sidebar contains a navigation menu with the following items: Live video, Setup Wizard, Settings, Advanced Setup, Camera Info, Camera Info, Time, Time Settings, Auto Time Config, Set Date and Time (highlighted), Administration Settings, and System Log. The main content area is titled 'SET DATE AND TIME MANUALLY' and includes a toggle for 'Set date and time manually' which is currently turned on. Below this, there are two buttons: 'time settings copy pc time' and 'Save'. The date and time are set using dropdown menus: Year (2013), Month (3), Day (9), Hour (1), Minute (03), and Second (21). The footer of the page reads 'Copyright ©2018 D-Link Corporation'.

Administration Settings

Admin Password

Here, you may modify the administrator's password for your camera.

New Password / Retype Password: Set a new password for the administrator's account.

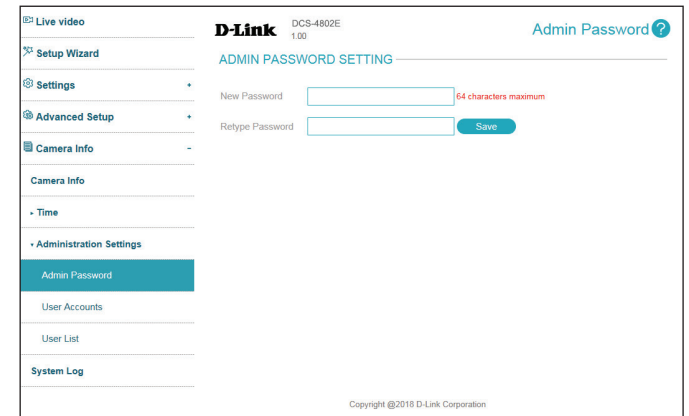

User Accounts

Here, you may add user accounts for accessing the camera. User accounts are allowed to access the Live Video page, but cannot access any of the camera's configuration pages.

User Name: Enter a user name for the user you wish to create.

New Password / Retype Password: Enter a password for the user you wish to create.

The screenshot shows the 'User Accounts' page in the D-Link DCS-4802E web interface. The page title is 'ADD USER ACCOUNT'. On the left, there is a navigation menu with options: Live video, Setup Wizard, Settings, Advanced Setup, Camera Info, Camera Info, Time, Administration Settings, Admin Password, User Accounts (highlighted), User List, and System Log. The main content area contains three input fields: 'User Name' (with a red note '17 users maximum'), 'New Password' (with a red note '64 characters maximum'), and 'Retype Password'. An 'Add' button is located to the right of the 'Retype Password' field. The D-Link logo and model number 'DCS-4802E 1.00' are at the top left, and 'User Accounts' with a help icon is at the top right. The footer contains the copyright notice 'Copyright ©2018 D-Link Corporation'.

User List

Here, you may manage the user accounts for accessing the camera.

User Name: If you want to change a user's password, select a user from the drop-down box, enter the new password, then click the **Modify** button.

If you want to remove a user from the user list, select a user from the drop-down box, then click the **Delete** button.

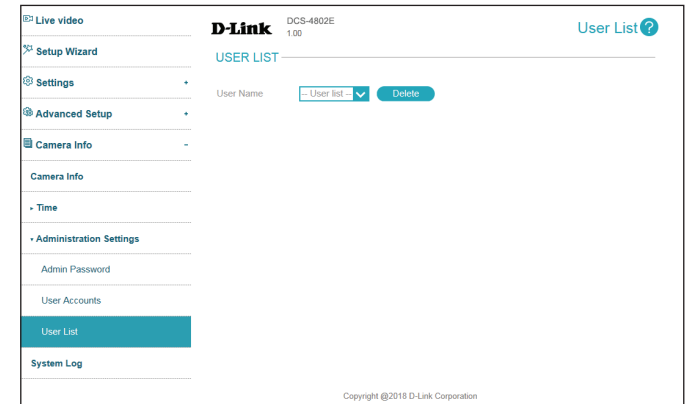

Camera Log

This page displays the log information of your camera. You may download the information by clicking **Download**. You may also click **Clear** to delete the saved log information.

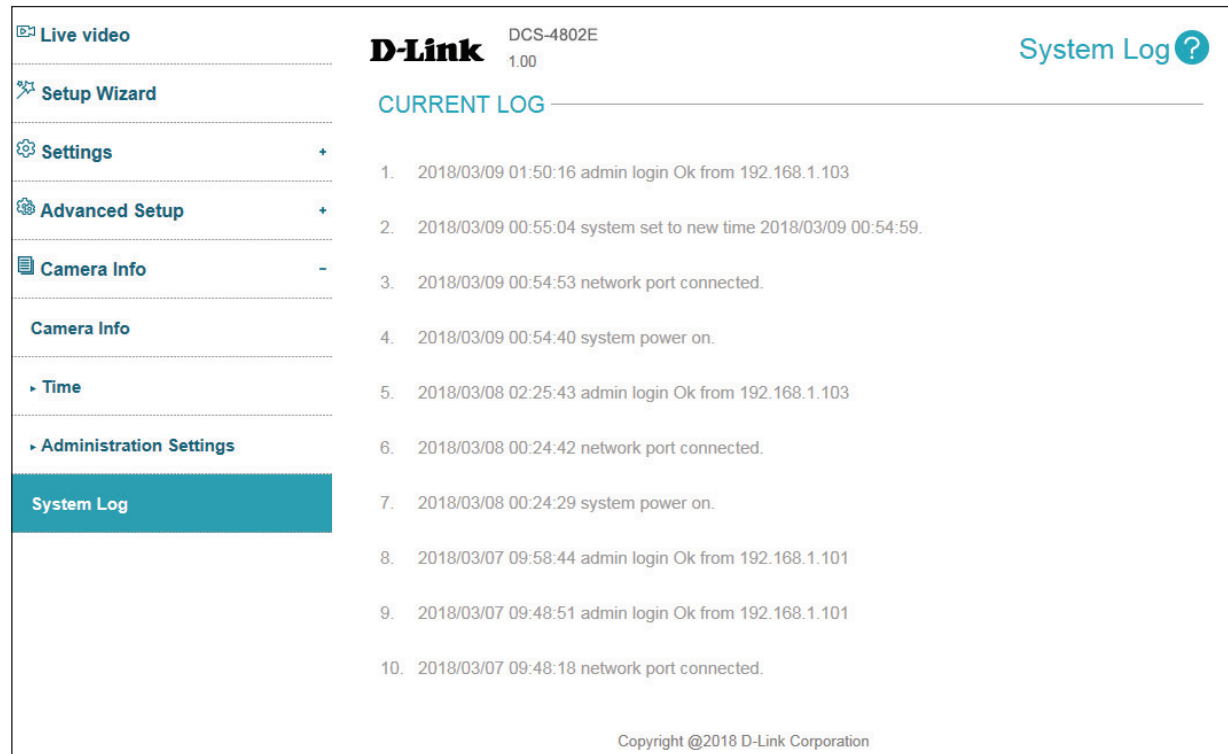

D-Link DCS-4802E 1.00 [System Log ?](#)

CURRENT LOG

1. 2018/03/09 01:50:16 admin login Ok from 192.168.1.103
2. 2018/03/09 00:55:04 system set to new time 2018/03/09 00:54:59.
3. 2018/03/09 00:54:53 network port connected.
4. 2018/03/09 00:54:40 system power on.
5. 2018/03/08 02:25:43 admin login Ok from 192.168.1.103
6. 2018/03/08 00:24:42 network port connected.
7. 2018/03/08 00:24:29 system power on.
8. 2018/03/07 09:58:44 admin login Ok from 192.168.1.101
9. 2018/03/07 09:48:51 admin login Ok from 192.168.1.101
10. 2018/03/07 09:48:18 network port connected.

Copyright ©2018 D-Link Corporation

Technical Specifications

Camera	Camera Hardware Profile	<ul style="list-style-type: none"> ▪ 1/2.7" 2 Megapixel progressive CMOS sensor ▪ 20 meter IR illumination distance ▪ Minimum illumination: <ul style="list-style-type: none"> ▪ Color (Day Mode), IR LEDs off: 1.0 lux ▪ B/W (Night Mode), IR LEDs off: 0.5 lux ▪ B/W (Night Mode), IR LEDs on: 0 lux ▪ Built-in Infrared-Cut Removable (ICR) Filter module ▪ 10x digital zoom ▪ Minimum object distance 0.5 m ▪ Focal length: 3.6 mm 	<ul style="list-style-type: none"> ▪ Aperture: F1.8 ▪ Angle of view: <ul style="list-style-type: none"> ▪ (H) 88° ▪ (V) 50° ▪ (D) 97° ▪ Adjustment angle (non-motorized): <ul style="list-style-type: none"> ▪ Vertical: 75° ▪ Horizontal: 360° ▪ Rotation: 360°
	Camera Housing	<ul style="list-style-type: none"> ▪ IP-66 compliant weatherproof housing 	
	Image Features	<ul style="list-style-type: none"> ▪ Configurable image size, quality, frame rate, and bit rate ▪ Time stamp and text overlays ▪ Configurable motion detection windows ▪ Configurable privacy mask zones 	<ul style="list-style-type: none"> ▪ Configurable exposure time, brightness, saturation, contrast, sharpness ▪ Wide Dynamic Range (WDR) ▪ 3D filtering
	Video Compression	<ul style="list-style-type: none"> ▪ Simultaneous H.265/H.264/MJPEG format compression ▪ H.265/H.264/MJPEG multicast streaming 	<ul style="list-style-type: none"> ▪ JPEG for still images
	Video Resolution	16:9 - 1920 x 1080, 1280 x 720, 800 x 448, 640 x 360 up to 30 fps ¹	4:3 - 1440 x 1080, 1280 x 960, 800 x 600, 640 x 480 up to 30 fps ¹
	External Device Interface	<ul style="list-style-type: none"> ▪ 10/100 BASE-TX Ethernet port with PoE (Class 2) 	<ul style="list-style-type: none"> ▪ Supports 802.3af PoE (Class 2)
Network	Network Protocols	<ul style="list-style-type: none"> ▪ IPv6 ▪ IPv4 ▪ ARP ▪ TCP/IP ▪ UDP ▪ ICMP ▪ DHCP client ▪ NTP client (D-Link) ▪ DNS client ▪ DDNS client (D-Link) ▪ SMTP client ▪ FTP client 	<ul style="list-style-type: none"> ▪ HTTP/HTTPS ▪ Samba client ▪ PPPoE ▪ UPnP port forwarding ▪ RTP/RTSP/RTCP ▪ IP filtering ▪ Multicast ▪ CoS ▪ QoS/DSCP ▪ SNMP ▪ Bonjour
	Security	Administrator and user group protection Password authentication	HTTP and RTSP authentication

Appendix A: Technical Specifications

System Management	System Requirements for Web Interface	<ul style="list-style-type: none"> Operating system: Microsoft Windows 10/8/7 or Mac OS X 10.9 or higher 	<ul style="list-style-type: none"> Browser: Internet Explorer 9 and higher (on Windows), Firefox 12-51, 52 ESR, Chrome 42 and higher, or Safari 9 and higher (on Mac OS X)
	Event Management	<ul style="list-style-type: none"> Motion detection Event notification and uploading of snapshots/video clips via e-mail or FTP 	<ul style="list-style-type: none"> Supports multiple SMTP and FTP servers Multiple event notifications Multiple recording methods for easy backup
	Remote Management	<ul style="list-style-type: none"> Take snapshots/video clips and save to local hard drive 	<ul style="list-style-type: none"> Configuration interface accessible via web browser
	D-ViewCam™ System Requirements	<ul style="list-style-type: none"> Operating System: <ul style="list-style-type: none"> 32-bit: Windows 8 / 7 (SP1) 64-bit: Windows 10 / 8 / 7 (SP1) / Server 2012 / Server 2008 R2 	<ul style="list-style-type: none"> Web Browser: Internet Explorer 8 or higher Protocol: Standard TCP/IP
	D-ViewCam™ Software Functions	<ul style="list-style-type: none"> Remote management/control of up to 32 cameras Supports all management functions provided in the web interface 	<ul style="list-style-type: none"> Viewing of up to 32 cameras on one screen Scheduled motion triggered, or manual recording options
General	Weight	370 grams (13 ounces) ± 5%	
	Power Input	12 V DC / 1.5 A, 50/60 Hz	IEEE 802.3af PoE Class 2
	Power Consumption	3.68 watts ± 5% (PoE Class 2)	
	Temperature	Operating: -30 to 50 °C (-22 to 122 °F)	Storage: -20° to 70° C (-4° to 158° F)
	Humidity	Operating: 20% to 80% non-condensing	Storage: 5% to 95% non-condensing
	Certifications	CE CE LVD ICES	FCC RCM

Dimensions

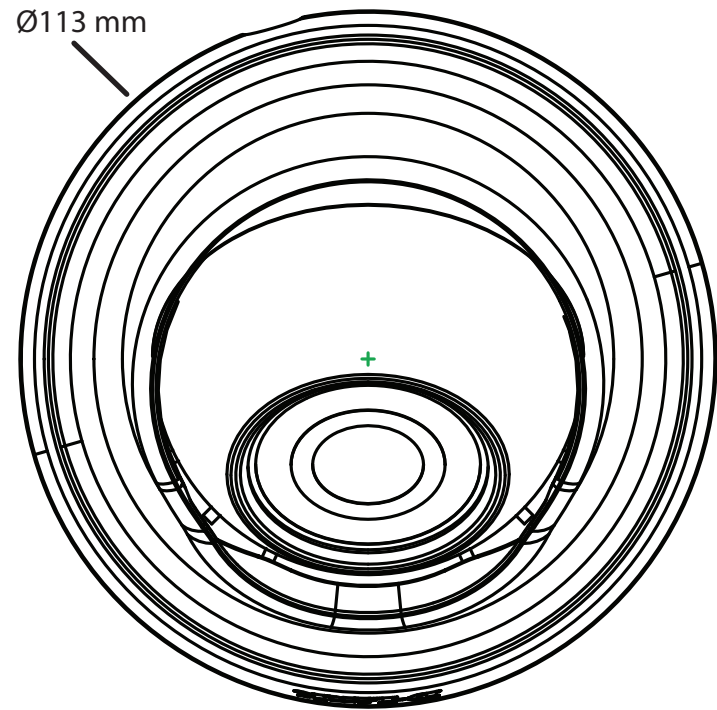
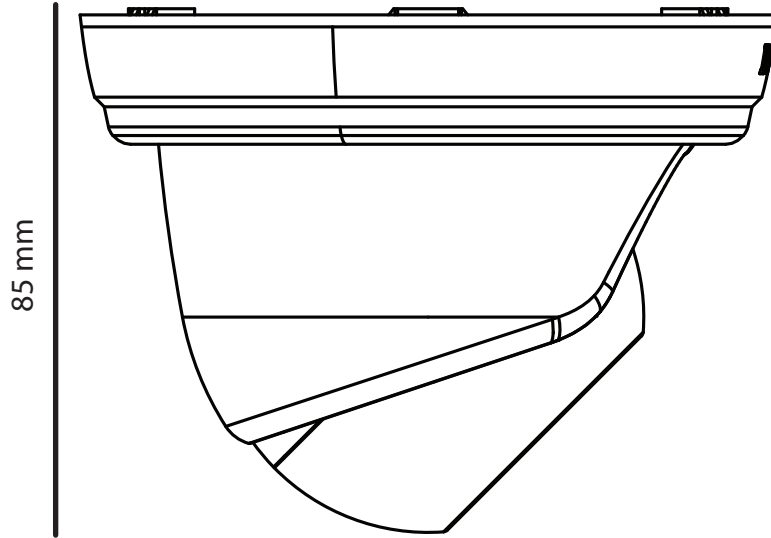

Regulatory Statements (Only for Class A product)

Federal Communication Commission Interference Statement

This equipment has been tested and found to comply with the limits for a Class A digital device, pursuant to part 15 of the FCC Rules. These limits are designed to provide reasonable protection against harmful interference when the equipment is operated in a commercial environment. This equipment generates, uses, and can radiate radio frequency energy and, if not installed and used in accordance with the instruction manual, may cause harmful interference to radio communications. Operation of this equipment in a residential area is likely to cause harmful interference in which case the user will be required to correct the interference at his own expense.

Non-modification Statement

Any changes or modifications not expressly approved by the party responsible for compliance could void the user's authority to operate the equipment.

Caution

This device complies with Part 15 of the FCC Rules. Operation is subject to the following two conditions:

(1) This device may not cause harmful interference, and (2) this device must accept any interference received, including interference that may cause undesired operation.

Innovation, Science and Economic Development Canada (ISED) Statement:

This Class A digital apparatus complies with Canadian ICES-003.

Cet appareil numérique de la classe A est conforme à la norme NMB-003 du Canada.

警告使用者:

此為甲類的資訊技術設備，在居住環境中使用時，可能會造成射頻擾動，在這種情況下，使用者會被要求採取某些適當的對策。

CE EMI Class A Warning

This equipment is compliant with Class A of CISPR 32. In a residential environment this equipment may cause radio interference.

Regulatory Statements (Only for Class B product)

Federal Communication Commission Interference Statement

This equipment has been tested and found to comply with the limits for a Class B digital device, pursuant to Part 15 of the FCC Rules. These limits are designed to provide reasonable protection against harmful interference in a residential installation. This equipment generates, uses and can radiate radio frequency energy and, if not installed and used in accordance with the instructions, may cause harmful interference to radio communications. However, there is no guarantee that interference will not occur in a particular installation. If this equipment does cause harmful interference to radio or television reception, which can be determined by turning the equipment off and on, the user is encouraged to try to correct the interference by one of the following measures:

- Reorient or relocate the receiving antenna.
- Increase the separation between the equipment and receiver.
- Connect the equipment into an outlet on a circuit different from that to which the receiver is connected.
- Consult the dealer or an experienced radio/TV technician for help.

Non-modification Statement

Any changes or modifications not expressly approved by the party responsible for compliance could void the user's authority to operate the equipment.

Caution

This device complies with Part 15 of the FCC Rules. Operation is subject to the following two conditions: (1) This device may not cause harmful interference, and (2) this device must accept any interference received, including interference that may cause undesired operation.

Innovation, Science and Economic Development Canada (ISED) Statement:

This Class B digital apparatus complies with Canadian ICES-003.

Cet appareil numérique de la classe B est conforme à la norme NMB-003 du Canada.

English

CE EMI CLASS A WARNING

This equipment is compliant with Class A of CISPR 32. In a residential environment this equipment may cause radio interference.

SAFETY INSTRUCTIONS

The following general safety guidelines are provided to help ensure your own personal safety and protect your product from potential damage. Remember to consult the product user instructions for more details.

- Static electricity can be harmful to electronic components. Discharge static electricity from your body (i.e. touching grounded bare metal) before touching the product.
- Do not attempt to service the product and never disassemble the product. For some products with a user replaceable battery, please read and follow the instructions in the user manual.
- Do not spill food or liquid on your product and never push any objects into the openings of your product.
- Do not use this product near water, areas with high humidity, or condensation unless the product is specifically rated for outdoor application.
- Keep the product away from radiators and other heat sources.
- Always unplug the product from mains power before cleaning and use a dry lint free cloth only.

DISPOSING AND RECYCLING YOUR PRODUCT

This symbol on the product or packaging means that according to local laws and regulations this product should be not be disposed of in the household waste but sent for recycling. Please take it to a collection point designated by your local authorities once it has reached the end of its life, some will accept products for free. By recycling the product and its packaging in this manner you help to conserve the environment and protect human health.



Bulgarian [България]

ПРЕДУПРЕЖДЕНИЕ ЗА СЪОТВЕТСТВИЕ С ЕВРОПЕЙСКАТА ОБЩНОСТ (СЕ) И ЕЛЕКТРОМАГНИТНИТЕ СМУЩЕНИЯ (ЕМИ) ОТНОСНО ПРОДУКТИ ОТ КЛАС А

Настоящото оборудване е в съответствие с Клас А по CISPR 32. В жилищна среда настоящото оборудване може да предизвика радиосмущения.

ИНСТРУКЦИИ ЗА БЕЗОПАСНОСТ

Следните общи насоки за безопасност се предоставят, за да Ви помогнат да гарантирате своята лична безопасност и да защитите продукта си от евентуална повреда. Не забравяйте да се консултирате с инструкциите за потребителя за повече подробности.

- Статичното електричество може да е опасно за електронните компоненти. Отстранете статичното електричество от тялото си (напр. като докоснете заземен открит метал) преди да пипате продукта.
- Не се опитвайте да ремонтирате продукта и никога не го разглобявайте. Относно някои продукти с батерия, която се сменя от потребителя, моля, прочетете и следвайте инструкциите в ръководството за потребителя.
- Не изсипвайте храни и напитки върху продукта и никога не вкарвайте предмети в отворите на Вашия продукт.
- Не използвайте продукта в близост до вода, зони с висока влажност или кондензация, освен ако продуктът не е специално одобрен за употреба на открито.
- Дръжте продукта далеч от радиатори и други източници на топлина.
- Винаги изключвайте продукта от контакта преди почистване и използвайте само сухи кърпи без мъх.

ИЗХВЪРЛЯНЕ И РЕЦИКЛИРАНЕ НА ВАШИЯ ПРОДУКТ



Този символ върху продукта или опаковката означава, че според местните закони и разпоредби, продуктът не бива да се изхвърля заедно с битови отпадъци, а да се изпрати за рециклиране. Моля, занесете го в посоченият от местните власти пункт за събиране на отпадъци, след като вече е достигнал края на полезния си живот. В някои пунктове се приемат такива продукти безплатно. Чрез рециклирането на продукта и опаковката по този начин, Вие помагате за опазването на природата и здравето на човека.

Czech [Česky]

UPOZORNĚNÍ NA CE EMI TŘÍDY A

Toto zařízení je v souladu s třídou A CISPR 32. V obytných oblastech může toto zařízení způsobovat rádiové rušení.

BEZPEČNOSTNÍ POKYNY

Dodržujte prosím následující bezpečnostní pravidla, která pomáhají zajistit vaši osobní bezpečnost a chránit výrobek před možným poškozením. Více podrobností najdete v pokynech pro uživatele výrobku.

- Statická elektřina může poškodit elektronické součástky. Dříve než se výrobku dotknete, zajistěte výboj statické elektřiny z těla (např. tak, že se dotknete uzemněného čistého kovu).
- Nepokoušejte se provádět servis výrobku a nikdy výrobek nedemontujte. V případě některých produktů s baterií vyměnitelnou uživatelem si prosím přečtěte pokyny uvedené v příručce pro uživatele.
- Na výrobek se nesmí dostat jídlo nebo tekutiny a do otvorů výrobku nesmíte zasouvat žádné předměty.
- Nepoužívejte tento výrobek v blízkosti vody, oblastí s vysokou vlhkostí nebo kondenzací, pokud je výrobek určen především pro používání v exteriéru.
- Výrobek uchovávejte mimo dosah radiátorů a jiných zdrojů tepla.
- Před čištěním výrobek vždy odpojte ze sítě a používejte pouze suchou látku bez vláken.

LIKVIDACE A RECYKLACE VÝROBKU



Tento symbol na výrobku nebo jeho obalu znamená, že podle místně platných předpisů se výrobek nesmí vyhazovat do komunálního odpadu, ale odeslat k recyklaci. Až výrobek doslouží, odнесите jej prosím na sběrné místo určené místními úřady k tomuto účelu. Některá sběrná místa přijímají výrobky zdarma. Recyklací výrobku i obalu pomáháte chránit životní prostředí i lidské zdraví.

Croatian [Hrvatski]

UPOZORENJE ZA CE EMI KLASU A

Ova oprema je sukladna s Klasom A CISPR-a 32. U stambenim okruženjima ova oprema može uzrokovati radijske interferencije.

SIGURNOSNE UPUTE

Sljedeće opće sigurnosne smjernice se pružaju kako bi se osigurala vaša osobna sigurnost i zaštita vašeg proizvoda od mogućeg oštećenja. Uvijek pogledajte korisničke upute za proizvod za više pojedinosti.

- Statički elektricitet može oštetiti elektroničke komponente. Ispraznite statički elektricitet iz svog tijela (npr. dodirujući uzemljeni neizolirani metal) prije dodirivanja proizvoda.
- Nemojte pokušavati servisirati proizvod i nikad nemojte rastavljati proizvod. Za proizvode u kojima se nalazi baterija koju mijenja korisnik, pročitajte upute u korisničkom priručniku i pridržavajte ih se.
- Nemojte prosipati hranu ili tekućinu na vaš proizvod i nikad nemojte gurati bilo koje predmete u otvore na proizvodu.
- Nemojte koristiti ovaj proizvod u blizini vode, u područjima s visokom vlažnošću ili kondenzacijom, osim ako je proizvod posebice namijenjen uporabi na otvorenom prostoru.
- Držite proizvod dalje od radijatora i drugih izvora toplote.
- Uvijek isključite proizvod iz električne utičnice prije čišćenja i za čišćenje upotrijebite samo suhu tkaninu koja ne otpušta dlake.

ODLAGANJE I RECIKLIRANJE VAŠEG PROIZVODA

Ovaj simbol na pakiranju proizvoda znači da, sukladno lokalnim zakonima i propisima, ovaj proizvod ne treba odlagati u kućni otpad, nego ga treba poslati na recikliranje. Na kraju životnog vijeka proizvoda odnesite proizvod u sakupljalište otpada koji odrede vaše lokalne vlasti, neka sakupljališta besplatno preuzimaju proizvode. Recikliranjem proizvoda i njegovog pakiranja na ovaj način pomažete u očuvanju okoliša i zaštiti zdravlja ljudi.

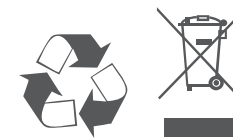

Danish [Dansk]

CE EMI-KLASSE A-ADVARSEL

Dette udstyr overholder Klasse A i CISPR 32. I et beboelsesmiljø kan dette udstyr medføre radiointerferens.

SIKKERHEDSFORSKRIFTER

Følgende generelle sikkerhedsforholdsregler gives for at sikre din personlige sikkerhed og beskytte produktet mod potentiel skade. Husk at se i produktets brugerinstruktioner for at få flere detaljer.

- Statisk elektricitet kan skade elektroniske komponenter. Aflad statisk elektricitet fra kroppen (dvs. berør jordet nøgent metal), før du berører produktet.
- Prøv ikke at servicere produktet, og tag det aldrig fra hinanden. Ved nogle produkter med et brugerudskifteligt batteri, skal du læse og følge instruktionerne i brugervejledningen.
- Spild ikke mad eller væsker på produktet, og skub aldrig nogen genstand ind i produktets åbninger.
- Brug ikke produktet tæt på vand, områder med høj fugtighed eller kondens, medmindre produktet er specifikt klassificeret til udendørs anvendelse.
- Opbevar produktet væk fra radiatorer og andre varmekilder.
- Træk altid produktet ud af stikkontakten, før du rengør, og brug kun en tør, fnugfri klud.



BORTSKAFFELSE OG GENBRUG AF PRODUKTET

Dette symbol på produktet eller emballagen betyder, at dette produkt i henhold til lokale love og regler ikke må bortskaffes som husholdningsaffald, mens skal sendes til genbrug. Indlever produktet til et indsamlingssted som angivet af de lokale myndigheder, når det er nået til slutningen af dets levetid. I nogle tilfælde vil produktet blive modtaget gratis. Ved at indlevere produktet og dets emballage til genbrug på denne måde bidrager du til at beskytte miljøet og den menneskelige sundhed.

Dutch [Nederlands]

CE EMI KLASSE A-WAARSCHUWING

Dit apparaat voldoet aan Klasse A van CISPR 32. Dit apparaat kan in een woonomgeving radio-interferentie veroorzaken.

VEILIGHEIDSINSTRUCTIES

De volgende algemene veiligheidsrichtlijnen worden verstrekt om uw eigen persoonlijke veiligheid te helpen garanderen en uw product tegen potentiële schade te beschermen. Raadpleeg de productinstructies voor meer details.

- Statische elektriciteit kan elektronische componenten beschadigen. Ontlaad de statische elektriciteit van uw lichaam (bijv. door een geaarde metalen objecten aan te raken) alvorens het product aan te raken.
- Probeer het product niet zelf te repareren of te demonteren. Voor producten met een door de gebruiker vervangbare batterij moet de gebruiker de instructies in de gebruikershandleiding lezen en volgen.
- Mors geen voedsel of vloeistof op uw product en duw geen voorwerpen in de openingen van uw product.
- Gebruik dit product niet in de buurt van water, plekken met hoge luchtvochtigheid of condensatie, tenzij het product speciaal voor buitengebruik is ontwikkeld.
- Houd uw product uit de buurt van radiatoren en andere warmtebronnen.
- Koppel het product altijd los van de stroomvoorziening alvorens het te reinigen en gebruik uitsluitend een droge pluisvrije doek.



AFVALVERWERKING EN RECYCLING VAN UW PRODUCT

Dit symbool op het product of op de verpakking betekent dat dit product in overeenstemming met lokale wetgeving en regelgevingen niet als huishoudelijk vuil mag worden verwerkt, maar voor recycling moet worden ingeleverd. Wanneer dit product het einde van zijn levensduur bereikt, moet het bij een door de gemeente erkend verzamelpunt worden ingeleverd. Bepaalde producten worden gratis geaccepteerd. Door het product en de verpakking te recyclen beschermt u het milieu en de menselijke gezondheid.

Finnish [Suomi]

CE EMI -LUOKAN VAROITUS

Tämä laite noudattaa CISPR 32:n mukaisia A-laitetta koskevia säädöksiä. Tämä laite saattaa aiheuttaa radiohäiriöitä asumisympäristössä.

TURVALLISUUSOHJEITA

Seuraavat turvallisuusohjeet on tarkoitettu varmistamaan turvallisuutesi ja suojaamaan tuotettasi mahdollisilta vaurioilta. Muista katsoa lisäohjeita tuotteen käyttöohjeista.

- Staattinen sähkö voi olla haitallista sähkökomponenteille. Pura kehoosi varautunut staattinen sähkö juuri ennen kuin kosket tuotetta (esim. koskettamalla maadoitettua paljasta metallipintaa).
- Älä yritä huoltaa tuotetta äläkä koskaan pura tuotetta. Jos tuotteessa on paristot, jotka käyttäjän täytyy vaihtaa, lue ja noudata käyttöoppaan ohjeita.
- Älä läikytä ruokaa tai nestettä tuotteeseen äläkä työnnä mitään esineitä tuotteesi aukkoihin.
- Älä käytä tätä tuotetta veden lähellä tai alueilla, joissa kosteus tai kondensaatio on suuri, jos tuotetta ei ole erityisesti luokiteltu käytettäväksi ulkona.
- Pidä tuote pois lämpöpatterien ja muiden lämpölähteiden läheltä.
- Irrota tuotteen pistoke aina verkkovirrasta ennen puhdistusta ja käytä vain nukatonta liinaa.

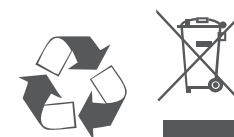

TUOTTEEN HÄVITTÄMINEN JA KIERRÄTTÄMINEN

Tämä symboli tuotteen pakkauksessa tarkoittaa, että paikallisten lakien ja säännösten mukaisesti tätä tuotetta ei pidä hävittää yleisen kotitalousjätteen seassa vaan se tulee toimittaa kierrätettäväksi. Kun tuote on elinkaarensa päässä, toimita se lähimpään viranomaisten hyväksymään kierrätyspisteeseen. Kierrättämällä käytetyn tuotteen ja sen pakkauksen autat tukemaan sekä ympäristön että ihmisten terveyttä ja hyvinvointia.

French [Français]

AVERTISSEMENT CE EMI CLASSE A

Cet équipement est conforme à la classe A de la norme CISPR 32. Dans un environnement résidentiel, cet équipement peut provoquer des interférences radio.

CONSIGNES DE SÉCURITÉ

Les consignes de sécurité générales suivantes sont fournies pour assurer votre propre sécurité et protéger votre produit des dommages potentiels. N'oubliez pas de consulter les instructions d'utilisation du produit pour plus de détails.

- L'électricité statique peut être dangereuse pour les composants électroniques. Déchargez l'électricité statique de votre corps (par ex., en touchant du métal nu mis à la terre) avant de toucher le produit.
- N'essayez pas de réparer le produit et ne le démontez jamais. Pour certains produits avec une batterie remplaçable par l'utilisateur, veuillez lire et suivre les instructions du mode d'emploi.
- Ne renversez pas de nourriture ou de liquide sur votre produit et n'introduisez jamais aucun objet dans les ouvertures de votre produit.
- N'utilisez pas ce produit à proximité d'eau, de zones très humides ou de condensation, à moins que le produit ne soit spécifiquement conçu pour une application extérieure.
- Gardez le produit à l'écart des radiateurs et autres sources de chaleur.
- Débranchez toujours l'appareil du secteur avant de le nettoyer et utilisez uniquement un chiffon sec non pelucheux.

MISE AU REBUT ET RECYCLAGE DE VOTRE PRODUIT

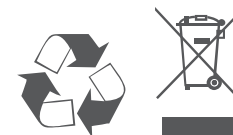

Ce symbole sur le produit ou l'emballage signifie que, conformément aux lois et règlements locaux, ce produit ne doit pas être jeté avec les ordures ménagères mais envoyé au recyclage. Veuillez le déposer à un point de collecte désigné par vos autorités locales une fois qu'il a atteint la fin de sa vie ; certains accepteront les produits gratuitement. En recyclant le produit et son emballage de cette manière, vous contribuez à préserver l'environnement et à protéger la santé humaine.

German [Deutsch]

WARNUNG ZUR CE EMI KLASSE A

Dieses Gerät entspricht Klasse A der CISPR 32. In einer Wohngebäudeumgebung kann dieses Gerät Funkstörungen verursachen.

SICHERHEITSVORSCHRIFTEN

Die folgenden Sicherheitshinweise sollen Ihre eigene Sicherheit gewährleisten und Ihr Produkt vor möglichen Schäden bewahren. Weitere Details finden Sie den Benutzeranweisungen zum Produkt.

- Statische Elektrizität kann schädlich für elektronische Komponenten sein. Entladen Sie statische Elektrizität von Ihrem Körper (z. B. durch Berühren von geerdetem Metall), ehe Sie das Produkt berühren.
- Versuchen Sie nicht, das Produkt zu reparieren und demontieren Sie es auf keinen Fall. Eine Produkte verwenden eine vom Benutzer auszutauschende Batterie. Bitte befolgen Sie die Anweisungen im Benutzerhandbuch.
- Schütten Sie keine Flüssigkeiten auf Ihr Produkt und stecken Sie keine Fremdkörper in die Öffnungen Ihres Produkts.
- Verwenden Sie dieses Produkt nicht in der Nähe von Wasser, in Bereichen mit hoher Feuchtigkeit oder Kondensation, es sei denn, das Produkt ist speziell für die Anwendung im Freien gedacht.
- Halten Sie Ihr Gerät von Heizkörpern und Quellen fern, die Wärme erzeugen.
- Trennen Sie das Gerät immer von der Steckdose, ehe Sie es reinigen, und verwenden Sie nur ein trockenes, fusselfreies Tuch.

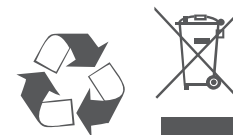

ENTSORGUNG UND RECYCLING IHRES PRODUKTS

Dieses Symbol auf dem Produkt oder der Verpackung weist darauf hin, dass dieses Produkt gemäß bestehender örtlicher Gesetze und Vorschriften nicht über den normalen Hausmüll entsorgt werden sollte, sondern einer Wiederverwertung zuzuführen ist. Bringen Sie es bitte zu einer von Ihrer Kommunalbehörde entsprechend amtlich ausgewiesenen Sammelstelle, sobald das Produkt das Ende seiner Nutzungsdauer erreicht hat. Für die Annahme solcher Produkte erheben einige dieser Stellen keine Gebühren. Durch ein auf diese Weise durchgeführtes Recycling des Produkts und seiner Verpackung helfen Sie, die Umwelt zu schonen und die menschliche Gesundheit zu schützen.

Greek [Ελληνικά]**ΠΡΟΕΙΔΟΠΟΙΗΣΗ CE EMI ΚΛΑΣΗΣ A**

Αυτό ο εξοπλισμός συμμορφώνεται με την Κλάση A του CISPR 32. Σε οικιακό περιβάλλον, αυτός ο εξοπλισμός ενδέχεται να προκαλέσει ραδιοπαρεμβολές.

ΟΔΗΓΙΕΣ ΑΣΦΑΛΕΙΑΣ

Οι ακόλουθες γενικές οδηγίες ασφάλειας παρέχονται με στόχο να σας βοηθήσουν να φροντίσετε την προσωπική σας ασφάλεια και να προστατεύσουν το προϊόν σας από ενδεχόμενη βλάβη. Θυμηθείτε να ανατρέξετε στις οδηγίες χρήστη του προϊόντος σας για περισσότερες λεπτομέρειες.

- Ο στατικός ηλεκτρισμός μπορεί να είναι επιβλαβής για τα ηλεκτρονικά εξαρτήματα. Εκφορτίστε τον στατικό ηλεκτρισμό από το σώμα σας (π.χ. αγγίζοντας ένα γειωμένο γυμνό μέταλλο) πριν αγγίξετε το προϊόν.
- Μην προσπαθήσετε να επισκευάσετε το προϊόν και ποτέ μην το αποσυναρμολογήσετε. Για ορισμένα προϊόντα με μπαταρία αντικαθιστώμενη από τον χρήστη, διαβάστε και ακολουθήστε τις οδηγίες που περιέχονται στο εγχειρίδιο χρήστη.
- Προσέξτε να μην πέσουν τροφές ή υγρά επάνω στο προϊόν και μην εισάγετε ποτέ αντικείμενα μέσα στα ανοίγματα του προϊόντος.
- Μην χρησιμοποιείτε το προϊόν κοντά σε νερό ή σε περιοχές με υψηλή υγρασία ή συμπύκνωση υδρατμών, εκτός εάν το προϊόν είναι ρητά χαρακτηρισμένο ως κατάλληλο για εφαρμογές σε εξωτερικούς χώρους.
- Κρατήστε το προϊόν μακριά από καλοριφέρ και άλλες πηγές θερμότητας.
- Να αποσυνδέετε πάντα το προϊόν από την παροχή ρεύματος πριν να το καθαρίσετε και να χρησιμοποιείτε μόνο ένα στεγνό πανί χωρίς χνούδια.

**ΑΠΟΡΡΙΨΗ ΚΑΙ ΑΝΑΚΥΚΛΩΣΗ ΤΟΥ ΠΡΟΪΟΝΤΟΣ**

Αυτό το σύμβολο στο προϊόν ή στη συσκευασία σημαίνει ότι, σύμφωνα με την τοπική νομοθεσία και τους κανονισμούς, το προϊόν δεν πρέπει να απορρίπτεται μαζί με οικιακά απορρίμματα αλλά να αποστέλλεται για ανακύκλωση. Όταν φτάσει στο τέλος της ζωής του, προσκομίστε το σε ένα σημείο συλλογής καθορισμένο από τις τοπικές αρχές· ορισμένα σημεία δέχονται προϊόντα χωρίς χρέωση. Ανακυκλώνοντας το προϊόν και τη συσκευασία του με αυτόν τον τρόπο, συμβάλλετε στην προστασία του περιβάλλοντος και της ανθρώπινης υγείας.

Hungarian [Magyar]

CE EMI A OSZTÁLYÚ FIGYELMEZTETÉS

Ez a berendezés megfelel a CISPR 32 A osztályának. Lakókörnyezetben ez a berendezés rádióinterferenciát okozhat.

BIZTONSÁGI UTASÍTÁSOK

Az alábbi általános biztonsági útmutató saját személyi biztonságát és a termék lehetséges meghibásodása elleni védelmét szolgálja. Ne feledje, hogy további részleteket a termék használati útmutatójában talál.

- A statikus elektromosság káros lehet az elektronikus alkatrészek számára. Vezesse el testéből a statikus elektromosságot (például földelt csupasz fém megérintésével), mielőtt hozzáérne a termékhez.
- Ne próbálkozzon a termék szervizelésével, és soha ne szedje szét a terméket. Egyes, felhasználó által cserélhető akkumulátorral rendelkező termékeknél olvassa el és kövesse a használati útmutatóban leírt utasításokat.
- Ne öntsön ételt vagy folyadékot a termékre, és soha ne nyomjon semmilyen tárgyat a termék nyílásaiba.
- Ne használja a terméket víz, magas páratartalmú vagy páralecsapódás által jellemzett hely közelében, hacsak a termék kifejezetten szabadtéri alkalmazásra nem készült.
- Tartsa távol a terméket radiátoroktól és más hőforrásoktól.
- Tisztítás előtt mindig húzza ki a termék tápkábelét, és csak száraz, szőszmentes ruhát használjon.

A TERMÉK HULLADÉKKEZELÉSE ÉS ÚJRAFELHASZNÁLÁSA

Ez a szimbólum a terméken vagy a csomagoláson azt jelenti, hogy a helyi törvényeknek és szabályoknak megfelelően ez a termék nem semmisíthető meg a háztartási hulladékkal együtt, hanem újrahasznosításra kell küldeni. Kérjük, hogy a termék élettartamának elteltét követően vigye azt a helyi hatóság által kijelölt gyűjtőhelyre. A termékek egyes helyeken ingyen elhelyezhetők. A termék és a csomagolás újrahasznosításával segíti védeni a környezetet és az emberek egészségét.



Icelandic [Íslenska]

VIÐVÖRUN FYRIR CE EMI FLOKK A

Þessi búnaður er í samræmi við Flokk A í CISPR 32. Þessi búnaður kann að valda fjarskiptatrufunum í íbúaumhverfi.

ÖRYGGISLEIÐBEININGAR

Eftirfarandi almennar öryggisleiðbeiningar eru veittar til að tryggja öryggi þitt og vernda vöruna gegn hugsanlegum skemmdum. Mundu að leita frekari upplýsinga í notkunarupplýsingum vörunnar.

- Stöðurafmagn getur skaðað rafræna hluti. Losaðu stöðurafmagn frá líkamanum (þ.e. með því að snerta jarðtengdan málm) áður en þú snertir vöruna.
- Ekki reyna að sinna viðhaldi á vörunni og aldrei taka hana í sundur. Vinsamlegast lestu og fylgdu leiðbeiningunum í notkunarhandbókinni fyrir þær vörur sem eru með endurnýjanlega rafhlöðu.
- Ekki missa mat eða vökva á vöruna og aldrei þrýsta hlutum í op á vörunni.
- Notaðu ekki þessa vöru nálægt vatni, svæðum með miklum raka eða þéttingu nema varan sé sérstaklega flokkuð fyrir notkun utandyra.
- Geymið vöruna í burtu frá ofnum og öðrum hitagjöfum.
- Vöruna skal ávallt taka úr sambandi fyrir þrif og notast skal aðeins við þurran klút.

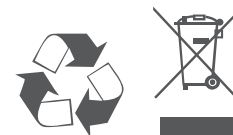

FÖRGUN OG ENDURVINNSLA VÖRUNNAR

Þetta tákn á vörunni eða umbúðunum þýðir að í samræmi við gildandi lög og reglugerðir skal ekki farga þessari vöru með heimilissorpi heldur skal senda hana til endurvinnslu. Vinsamlegast farðu með hana á söfnunarstað sveitarfélags þíns þegar hún hefur ná endingartíma sónum, sumir staðir taka við vörum án endurgjalds. Með því að endurvinna vöruna og umbúðir hennar með þessum hætti hjálpar þú að varðveita umhverfið og vernda heilsu manna.

Italian [Italiano]

CE EMI CLASSE A AVVISO

La presente apparecchiatura è conforme alla Classe A di CISPR 32. In ambienti residenziali, questa apparecchiatura potrebbe causare interferenze radio.

ISTRUZIONI PER LA SICUREZZA

Le seguenti linee generali sulla sicurezza sono fornite per contribuire a garantire la sicurezza personale e proteggere il prodotto da potenziali danni. Per ulteriori dettagli consultare le istruzioni per l'utente:

- L'elettricità statica può essere dannosa per i componenti elettrici. Scaricare l'elettricità statica dal corpo (toccando ad esempio una piastra di metallo con messa a terra).
- Non tentare di riparare il prodotto o di smontarlo. Per i prodotti con batterie sostituibili dall'utente, leggere le istruzioni nell'apposito manuale.
- Non versare alimenti o liquidi nel prodotto né spingere oggetti all'interno delle aperture del prodotto.
- Non usare il prodotto vicino all'acqua, in aree con molta umidità o condensa, tranne se specificamente indicato che il prodotto può essere usato in applicazioni all'aperto.
- Tenere il prodotto lontano da caloriferi e fonti di calore.
- Scollegare sempre il prodotto dalla presa di alimentazione prima di pulirlo e usare un panno pulito senza pelucchi.

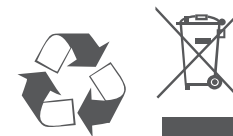

SMALTIMENTO E RICICLO DEL PRODOTTO

La presenza di questo simbolo sul prodotto o sulla confezione del prodotto indica che, in conformità alle leggi e alle normative locali, questo prodotto non deve essere smaltito nei rifiuti domestici, ma avviato al riciclo. Una volta terminato il ciclo di vita utile, portare il prodotto presso un punto di raccolta indicato dalle autorità locali. Alcuni questi punti di raccolta accettano gratuitamente i prodotti da riciclare. Scegliendo di riciclare il prodotto e il relativo imballaggio, si contribuirà a preservare l'ambiente e a salvaguardare la salute umana.

Maltese [Malti]

TWISSIJA CE EMI CLASS A

Dan it-tagħmir huwa konformi mal-Klassi A tas-CISPR 32. F'ambjent residenzjali dan it-tagħmir jista' jikkawża interferenza tar-radju.

STRUZZJONIJIET DWAR IS-SIGURTÀ

Dawn il-linji gwida ġenerali ta' sikurezza li ġejjin huma pprovduti biex jgħinu jiżguraw is-sigurtà personali tiegħek stess u jipproteġu l-prodott tiegħek minn ħsara potenzjali. Ftakar biex tikkonsulta l-istruzzjonijiet tal-utent tal-prodott għal aktar dettalji.

- L-elettriku statiku jista' jkun ta' ħsara għall-komponenti elettronici Skarika l-elettriku statiku mill-ġisem tiegħek (jiġifieri miss ma' metall mhux miksi) qabel tmiss il-prodott.
- Tipprovax tisservisja l-prodott u qatt m'għandek iżżarma l-prodott. Għal xi prodotti b' batterja sostitwibbli mill-utent, aqra u segwi l-istruzzjonijiet fil-manwal tal-utent.
- Ixxerridx ikel jew likwidu fuq il-prodott tiegħek u qatt m'għandek iddañhal xi oġġetti fil-fetħiet tal-prodott tiegħek.
- Tużax dan il-prodott qrib l-ilma, żoni b'umdità għolja, jew kondensazzjoni sakemm il-prodott ma jkunx speċifikament ikklassifikat għall-applikazzjoni fuq barra.
- Żomm il-prodott 'il bogħod minn radjaturi u sorsi oħra ta' sħana.
- Dejjem aqla' l-prodott mill-kurrent tal-elettriku qabel tnaddfu u uża biss drapp xott mingħajr tniyetex.



IR-RIMI U R-RIĊIKLAGĠ TAL-PRODOTT TIEGĦEK

Dan is-simbolu fuq il-prodott jew l-imballaġġ ifisser li skont il-liġijiet u r-regolamenti lokali dan il-prodott m'għandux jintrema fl-iskart domestiku imma jintbagħat għar-riċiklaġġ. Jekk jogħġbok ħudu f'punt ta' ġbir magħżul mill-awtoritajiet lokali tiegħek ladarba ma jkunx jista' jibqa' jintuża, xi wħud jaċċettaw prodotti b'xejn. Meta tirriċikla l-prodott u l-ippakkjar tiegħu b'dan il-mod inti tgħin biex tikkonserva l-ambjent u tipproteġi s-saħħa tal-bniedem.

Norwegian [Norsk]

CE EMI KLASSE A ADVARSEL

Dette utstyret samsvarer med klasse A i CISPR 32. Dette utstyret kan forårsake radioforstyrrelser i bostedsområder.

SIKKERHETSINSTRUKSJONER

Følgende generelle sikkerhetsforbehold er forsynt for å hjelpe med å sikre din egen personlige sikkerhet, og beskytte produktet fra potensiell skade. Husk å se produktets brukerinstruksjoner for mer informasjon.

- Statisk elektrisitet kan være skadelig for elektriske komponenter. Utlad statisk elektrisitet fra kroppen (f.eks. ved å berøre jordet metall) før berøring av produktet.
- Ikke forsøk å utføre service på produktet, og aldri ta produktet fra hverandre. For produkter med et batteri som kan skiftes av brukeren, les og følg instruksjonene i brukerhåndboken.
- Ikke søl mat eller væske på produktet, og dytt aldri gjenstander inn i produktets åpninger.
- Ikke bruk dette produktet i nærheten av vann, områder med høy fuktighetsgrad, eller kondensering, dersom produktet ikke er spesielt ment for utendørsbruk.
- Hold produktet unna radiatorer og andre varmekilder.
- Trekk alltid ut produktets støpsel fra hovedstrømmen før rengjøring, og bruk kun en tørr, lofri klut.

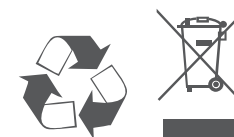

AVHENDIG OG GJENVINNING AV PRODUKTET

Dette symbolet på produkt eller emballasje betyr at i henhold til lokale lover og forskrifter skal dette produktet ikke avhendes i husholdningsavfallet, men sendes for gjenvinning. Bring produktet til et innsamlingspunkt designert av dine lokale myndigheter etter at det har nådd enden av sitt livsløp. Enkelte vil akseptere produktet gratis. Ved å gjenvinne produktet og emballasjen på denne måten, hjelper du med å bevare miljøet og beskytte personhelse.

Polish [Polski]

OSTRZEŻENIE CE EMI KLASAA

Ten sprzęt jest zgodny z klasą A normy CISPR 32. W strefach zamieszkania ten sprzęt może powodować zakłócenia radiowe

INSTRUKCJE DOTYCZĄCE BEZPIECZEŃSTWA

W celu zapewnienia osobistego bezpieczeństwa oraz ochrony produktu przed możliwym uszkodzeniem, należy stosować się do poniższych ogólnych zasad bezpieczeństwa. Więcej szczegółowych informacji można znaleźć w instrukcjach obsługi produktów.

- Elektryczność statyczna może być szkodliwa dla podzespołów elektronicznych. Przed dotknięciem produktu należy odprowadzić elektryczność statyczną ze swojego ciała (np. dotykając uziemionego metalu).
- Nie próbować naprawiać produktu ani go demontować. W przypadku produktów z baterią wymienianą przez użytkownika przeczytać odpowiednie instrukcje w podręczniku użytkownika i stosować się do nich.
- Chronić przed kontaktem z żywnością i cieczami; nigdy nie wkładać żadnych przedmiotów w otwory produktu.
- Nie używać tego produktu w pobliżu wody ani w środowisku z wysoką wilgotnością lub kondensacją, o ile produkt nie jest przeznaczony do zastosowań zewnętrznych.
- Trzymać produkt z dala od grzejników i źródeł ciepła.
- Zawsze odłączać produkt od sieci elektrycznej przed czyszczeniem; czyścić wyłącznie suchą, niepyłącą szmatką.

UTYLIZACJA I RECYKLING PRODUKTU



Ten symbol umieszczony na produkcie lub opakowaniu oznacza, że zgodnie z miejscowym prawem i lokalnymi przepisami niniejszego produktu nie wolno wyrzucać jak odpady czy śmieci z gospodarstwa domowego, lecz należy go poddać procesowi recyklingu. Po zakończeniu użytkowania produktu, niektóre odpowiednie do tego celu podmioty przyjmą takie produkty nieodpłatnie, dlatego, prosimy dostarczyć go do punktu zbiórki, wskazanego przez lokalne władze. Poprzez proces recyklingu i dzięki takiemu postępowaniu z produktem oraz jego opakowaniem, pomogą Państwo chronić środowisko naturalne i dbać o ludzkie zdrowie.

Portuguese [Português]

AVISO CE SOBRE EMISSÕES DA CLASSE A

Este equipamento é compatível com a Classe A da CISPR 32. Em ambiente residencial, este equipamento pode causar interferência de rádio.

INSTRUÇÕES DE SEGURANÇA

São indicadas as seguintes diretrizes gerais de segurança para o ajudar a garantir a sua segurança pessoal e para proteger o seu produto de potenciais danos. Recorde que deve consultar as instruções de utilizador do produto para obter mais detalhes.

- A eletricidade estática pode ser prejudicial para os componentes eletrónicos. Descarregue a eletricidade estática do seu corpo (ou seja, toque numa peça de metal sem isolamento e ligada à terra) antes de tocar o produto.
- Não tente reparar o produto e nunca o desmonte. Para alguns produtos com bateria substituível pelo utilizador, leia e siga as instruções no respetivo manual de utilizador.
- Não derrame alimentos ou líquidos sobre o seu produto e nunca introduza quaisquer objetos através das aberturas do aparelho.
- Não use este produto na proximidade de água, áreas com elevados índices de humidade ou condensação, exceto se o produto estiver especificamente classificado para utilização em espaços exteriores.
- Mantenha o produto afastado de radiadores e outras fontes de calor.
- Desligue sempre o produto da fonte de alimentação antes de limpar e use apenas um pano de microfibras seco.

ELIMINAÇÃO E RECICLAGEM DO SEU PRODUTO



Este símbolo no produto ou na embalagem significa que, de acordo com as leis e regulamentações locais, este produto não deverá ser eliminado juntamente com o lixo doméstico mas que deve ser enviado para reciclagem. Entregue-o para um ponto de recolha designado pelas suas autoridades locais no fim da sua vida útil. Alguns destes pontos aceitam os produtos gratuitamente. Ao reciclar o produto e a respetiva embalagem desta forma, ajuda a preservar o ambiente e protege a saúde humana.

Romanian [Română]

AVERTIZARE PRIVIND CLASA A EMI CE

Acest echipament este conform cu Clasa A din CISPR 32. Într-un mediu rezidențial, acest echipament poate cauza interferență radio.

INSTRUCȚIUNI DE SIGURANȚĂ

Următoarele linii directoare generale de siguranță sunt furnizate pentru a ajuta la asigurarea siguranței dumneavoastră personale și pentru a proteja produsul împotriva potențialei deteriorări. Rețineți să consultați instrucțiunile de utilizare a produsului pentru mai multe detalii.

- Electricitatea statică poate fi periculoasă pentru componentele electronice. Descărcați electricitatea statică din corpul dumneavoastră (adică atingeți un obiect de metal legat la pământ) înainte de a atinge produsul.
- Nu încercați să depanați produsul și nu demontați niciodată produsul. Pentru unele produse a căror baterie poate fi înlocuită de utilizator, vă rugăm să citiți și să respectați instrucțiunile din manualul de utilizare.
- Nu turnați alimente sau lichid pe produs și nu împingeți niciodată obiecte în orificiile produsului.
- Nu utilizați acest produs în apropierea apei, în condiții de umiditate sau condens decât dacă produsul este special clasificat pentru aplicații în aer liber.
- Țineți produsul la distanță de radiatoare și alte surse de căldură.
- Deconectați întotdeauna produsul de la priza de rețea înainte de curățare și utilizați doar o lavetă uscată care nu lasă scame.



ELIMINAREA LA DEȘEURI ȘI RECICLAREA PRODUSULUI

Acest simbol aplicat pe produs sau pe ambalaj înseamnă că, în conformitate cu legile și reglementările locale, acest produs nu trebuie să fie aruncat cu deșeurile menajere, ci trebuie să fie trimis pentru reciclare. Vă rugăm ca, după ce a ajuns la sfârșitul duratei de viață, să îl predați la un centru de colectare desemnat de autoritățile locale. Unele dintre aceste centre acceptă produsele gratuit. Prin reciclarea produsului și a ambalajului său în acest mod, ajutați la conservarea mediului și la protecția sănătății umane.

Slovak [Slovenský]

VAROVANIE PODĽA CE EMI TRIEDA A

Toto zariadenie je v súlade s triedou A predpisu CISPR 32. V obytnom prostredí môže toto zariadenie spôsobovať rádiové rušenie.

BEZPEČNOSTNÉ POKYNY

V rámci zaistenia vlastnej bezpečnosti a ochrany systému pred možným poškodením dodržiavajte nasledujúce všeobecné bezpečnostné usmernenia. Ďalšie podrobnosti nájdete v pokynoch na používanie výrobku.

- Statická elektrina môže poškodzovať elektronické súčasti. Pred tým, než sa dotknete výrobku, vybite z tela statickú elektrinu (tzn. tak, že sa dotknete uzemneného kovu).
- Nepokúšajte sa výrobok opravovať ani ho nikdy nerozoberajte. Pri niektorých výrobkoch s používateľom vymeniteľnou batériou si prečítajte pokyny v používateľskej príručke a dodržiavajte ich.
- Výrobok nesmie prísť do styku s jedlom ani tekutinou. Do otvorov na výrobku nikdy nekladajte žiadne predmety.
- Nepoužívajte výrobok blízko vody, na miestach s vysokou vlhkosťou alebo kondenzáciou, ak výrobok nie je výslovne určený na používanie v exteriéri.
- Zariadenie neumiestňujte do blízkosti radiátorov ani iných zdrojov tepla.
- Pred čistením vždy výrobok odpojte od elektrickej siete a používajte len suchú handričku, ktorá nepúšťa vlákna.

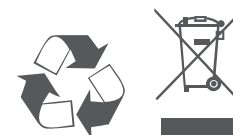

LIKVIDÁCIA A RECYKLÁCIA VÝROBKU

Tento symbol na výrobku alebo na obale znamená, že v súlade s miestnymi zákonmi a predpismi nesmie byť tento výrobok likvidovaný v bežnom domovom odpade, ale musí byť odoslaný na recykláciu. Zaneste ho na zberné miesto určený miestnymi úradmi, keď uplynie jeho životnosť. Niektoré z nich prevezmú výrobok bezplatne. Recykláciou výrobku a jeho obalu týmto spôsobom pomáhate zachovávať životné prostredie a chrániť ľudské zdravie.

Slovenian [Slovenski]

OPOZORILO CE EMI ZA RAZRED A

Ta oprema je združljiva z razredom A CISPR 32. V stanovanjskem okolju lahko povzroča radijske motnje.

VARNOSTNA NAVODILA

Spodnja splošna varnostna navodila so navedena kot pomoč pri zagotavljanju vaše varnosti in zaščiti izdelka pred morebitno škodo. Za podrobnosti ne pozabite prebrati uporabniških navodil za izdelek.

- Statična elektrika lahko poškoduje elektronske komponente. Preden se dotaknete izdelka, se razelektrite (tako da se dotaknete gole ozemljene kovinske površine).
- Ne poskušajte servisirati izdelka in ga nikoli ne razstavlajte. Za izdelke z akumulatorjem, ki ga lahko zamenja uporabnik, preberite in upoštevajte navodila v uporabniškem priročniku.
- Po izdelku ne stresajte hrane ali polivajte tekočin in v odprtine izdelka nikoli ne potiskajte predmetov.
- Tega izdelka ne uporabljajte v bližini vode ali na mestih z visoko stopnjo vlažnosti ali kondenzacije, razen če je izdelek izrecno namenjen za zunanjo uporabo.
- Izdelek postavite stran od radiatorjev in drugih virov toplote.
- Pred čiščenjem izdelek vedno izklopite iz električnega napajanja in uporabljajte samo suho krpo brez vlaken.

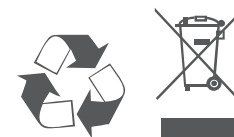

ODLAGANJE IN RECIKLIRANJE IZDELKA

Ta simbol na izdelku ali embalaži pomeni, da izdelka v skladu z lokalno zakonodajo ali predpisi ni dovoljeno odvreči med gospodinjske odpadke, pač pa ga je treba reciklirati. Ko izdelek doseže konec svoje življenjske dobe, ga odnesite na zbirno mesto, ki so ga določili lokalni organi; nekateri sprejemajo izdelke brezplačno. Z recikliranjem izdelka in njegove embalaže na ta način pomagate ohranjati okolje in varovati zdravje ljudi.

Spanish [Español]

ADVERTENCIA DE CE EMI CLASE A

Este equipo cumple la Clase A de CISPR 32. En un entorno residencial, este equipo podría provocar interferencias de radio.

INSTRUCCIONES DE SEGURIDAD

Las siguientes directrices de seguridad generales se proporcionan para ayudar a garantizar su propia seguridad personal y proteger el sistema de posibles daños. Recuerde consultar las instrucciones de uso del producto para obtener más información.

- La electricidad estática puede ser dañina para los componentes electrónicos. Descargue la electricidad estática de su cuerpo (por ejemplo, tocando un metal desnudo conectado a tierra) antes de tocar el producto.
- No intente reparar el producto y nunca desarme el producto. Para algunos productos con una batería reemplazable por el usuario, lea y siga las instrucciones del manual del usuario.
- No derrame comida o líquido sobre su producto y nunca introduzca ningún objeto en las aberturas del producto.
- No utilice este producto cerca del agua, áreas con alta humedad o condensación a menos que el producto esté específicamente especificado para aplicaciones en exteriores.
- Mantenga el dispositivo alejado de radiadores y fuentes de calor.
- Mantenga el producto alejado de radiadores y otras fuentes de calor.

DESECHAR Y RECICLAR EL PRODUCTO

Este símbolo en el producto o el embalaje significa que, de acuerdo con la legislación y la normativa local, este producto no se debe desechar en la basura doméstica sino que se debe reciclar. Llévela a un punto de recogida designado por las autoridades locales una vez que haya llegado al final de su ciclo de vida; algunos aceptan productos de forma gratuita. Al reciclar el producto y su embalaje de esta manera, ayuda a conservar el medio ambiente y proteger la salud humana.



Swedish [Svenska]

CE EMI KLASS A-VARNING

Den här utrustningen efterlever Klass A i CISPR 32. Den här utrustningen kan orsaka radiostörningar i bostadsområden.

SÄKERHETSINSTRUKTIONER

Följande allmänna säkerhetsriktlinjer tillhandahålls för att hjälpa dig att säkerställa din egen personliga säkerhet och skydda din produkt från eventuell skada. Kom ihåg att se produktens användarinstruktioner och få mer information.

- Statisk elektricitet kan vara skadlig för elektriska komponenter. Ladda ur statisk elektricitet från din kropp (dvs. rör vid jordad metall) innan du rör vid produkten.
- Försök inte att utföra service på produkten och montera aldrig isär den. Vissa produkter har ett batteri som användaren kan byta, läs och följ instruktionerna i användarbruksanvisningen.
- Spill inte livsmedel eller vätska på din produkt och tryck aldrig in några föremål i din produkts öppningar.
- Använd inte den här produkten nära vatten, områden med hög luftfuktighet eller kondensering, såvida inte produkten är särskilt klassad för utomhusanvändning.
- Håll produkten på avstånd från element och andra värmekällor.
- Koppla alltid bort produkten från elnätet innan du rengör och använd endast en torr luddfri trasa.

KASSERING OCH ÅTERVINNING AV DIN PRODUKT

Den här symbolen på produkten eller förpackningen betyder att den här produkten enligt lokala lagar och bestämmelser inte ska kastas i hushållsavfallet utan lämnas in för återvinning. Ta den till en uppsamlingsplats som dina lokala myndigheter utsett när den har nått slutet av sin livslängd, vissa tar emot produkter kostnadsfritt. Genom att återvinna produkten och dess förpackning på det här sättet hjälper du till att bevara miljön och skydda människors hälsa.

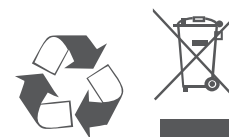



GPL Code Statement

This D-Link product includes software code developed by third parties, including software code subject to the GNU General Public License (“[GPL](#)”) or GNU Lesser General Public License (“[LGPL](#)”). As applicable, the terms of the GPL and LGPL, and information on obtaining access to the GPL code and LGPL code used in this product, are available to view the full GPL Code Statement at:

<https://tsd.dlink.com.tw/GPL>

The GPL code and LGPL code used in this product is distributed WITHOUT ANY WARRANTY and is subject to the copyrights of one or more authors. For details, see the GPL code and the LGPL code for this product and the terms of the GPL and LGPL.

Written Offer for GPL and LGPL Source Code

Where such specific license terms entitle you to the source code of such software, D-Link will provide upon written request via email and/or traditional paper mail the applicable GPL and LGPL source code files via CD-ROM for a nominal cost to cover shipping and media charges as allowed under the GPL and LGPL.

Please direct all inquiries to:

Email:

GPLCODE@dlink.com

Snail Mail:

Attn: GPLSOURCE REQUEST
D-Link Systems, Inc.
17595 Mt. Herrmann Street
Fountain Valley, CA 92708