



# User Manual

## Wireless AC Day/Night HD Mini Bullet Cloud Camera

DCS-7000L

---

# Manual Overview

D-Link reserves the right to revise this publication and to make changes in the content hereof without obligation to notify any person or organization of such revisions or changes. Information in this document may become obsolete as our services and websites develop and change. Please refer to the [www.mydlink.com](http://www.mydlink.com) website for the most current information.

## Manual Revisions

Revision	Date	Description
1.0	May 5, 2014	DCS-7000L Revision A1 with firmware version 1.00
1.01	Oct 07,2015	Minor updates.

## Trademarks

D-Link and the D-Link logo are trademarks or registered trademarks of D-Link Corporation or its subsidiaries in the United States or other countries. All other company or product names mentioned herein are trademarks or registered trademarks of their respective companies.

Copyright © 2015 D-Link Corporation.

All rights reserved. This publication may not be reproduced, in whole or in part, without prior expressed written permission from D-Link Corporation.

---

# Table of Contents

<b>Manual Overview.....</b>	<b>2</b>	Setup Wizard .....	25
Manual Revisions.....	2	Network Setup.....	31
Trademarks .....	2	Wireless Setup.....	34
<b>Product Overview.....</b>	<b>4</b>	Dynamic DNS .....	35
Package Contents.....	4	Image Setup .....	36
Introduction .....	6	Audio and Video.....	38
Features.....	7	Preset.....	40
Hardware Overview .....	8	Motion Detection .....	42
Front .....	8	Sound Detection.....	43
Rear .....	9	Time and Date.....	44
Adjusting Camera Focus .....	10	Event Setup.....	45
<b>Software Installation.....</b>	<b>11</b>	SD Card.....	52
Zero Configuration Setup.....	12	Advanced .....	53
Camera Setup Wizard.....	16	ICR and IR.....	53
Windows Users .....	16	HTTPS.....	54
Mac Users.....	17	Access List.....	55
Manual Hardware Installation.....	18	Maintenance .....	56
Wireless Installation Considerations.....	19	Device Management .....	56
WPS - Push Button Setup.....	20	System .....	57
<b>mydlink.....</b>	<b>21</b>	Firmware Upgrade.....	58
<b>Configuration.....</b>	<b>22</b>	Status .....	59
Live Video .....	23	Device Info .....	59
Setup.....	25	Logs .....	60
		Help .....	61
		<b>Technical Specifications .....</b>	<b>62</b>

# Product Overview

## Package Contents



DCS-7000L Wireless AC Day/Night HD Mini Bullet Cloud Camera



Wall mount kit



Power adapter



CD-ROM with User Manual and software



Quick Installation Guide

If any of the above items are missing, please contact your reseller.

**Note:** Using a power supply with a different voltage than the one included with your product will cause damage and void the warranty for this product.

# System Requirements

<b>Network Requirements</b>	<ul style="list-style-type: none"><li>• Wired (10/100 Fast Ethernet) or Wireless (802.11ac/n/g/a) network</li><li>• Broadband modem and subscription with an Internet Service Provider</li></ul>
<b>CD Setup Wizard Requirements</b>	<b>Computer with the following:</b> <ul style="list-style-type: none"><li>• A PC with a connection to your router</li><li>• Windows 8/7/Vista, Mac OS X 10.7 or above</li></ul>
<b>Web-based Configuration Utility Requirements</b>	<b>Browser Requirements:</b> <ul style="list-style-type: none"><li>• Internet Explorer 8 or higher</li><li>• Firefox 12 or higher</li><li>• Safari 6 or higher</li></ul> <p><b>Note:</b> Make sure you have the latest version of Java installed. Visit <a href="http://www.java.com">www.java.com</a> to download the latest version.</p>
<b>mydlink Website Requirements</b>	<ul style="list-style-type: none"><li>• Broadband Internet connection</li><li>• Computer with:<ul style="list-style-type: none"><li>• Internet Explorer 8 or higher</li><li>• Firefox 12 or higher</li><li>• Safari 6 or higher</li><li>• Chrome 20 or higher</li></ul></li></ul>

## Introduction

Congratulations on your purchase of the DCS-7000L Wireless AC Day/Night HD Mini Bullet Cloud Camera, a versatile surveillance and security solution for your home or small office. Designed for indoor day or night operation, the camera supports distances of up to five meters in darkness.

With Wireless AC support which eliminates the need for network cabling, the DCS-7000L can be accessed remotely, and controlled from any PC or notebook over your local network or through the Internet using a web browser. The simple installation and intuitive web-based interface offer easy integration with your existing network.

The included D-Link D-ViewCam™ is a sophisticated piece of software which allows users to manage up to 32 network cameras, set email alert notifications, create recording schedules, and use motion detection to record directly to a hard drive. D-ViewCam™ also allows users to upload a floor plan to create a realistic layout of the premises where cameras are located, further simplifying the management process.

## Features

### **Simple to Use**

The DCS-7000L is a stand-alone system with a built-in CPU, requiring no special hardware or software. The DCS-7000L supports both ActiveX mode for Internet Explorer and Java mode for other browsers such as Chrome®, Firefox®, and Safari®.

### **Supports a Variety of Platforms**

Supports TCP/IP networking, HTTP, and other Internet related protocols. The DCS-7000L can also be integrated easily into other Internet/Intranet applications because of its standards-based features.

### **Web Configuration**

Using a standard Web browser, administrators can configure and manage the DCS-7000L directly from its own Web page via Intranet or Internet. This means you can access your DCS-7000L anytime, anywhere in the world.

### **All-Day Surveillance with low light color image capability**

With built-in infrared LEDs let you monitor an area 24 hours a day, even in areas with low light or complete darkness, the DCS-7000L is a versatile surveillance and security monitoring device.

### **Broad Range of Applications**

With today's high-speed Internet services, the DCS-7000L can provide the ideal solution for delivering live video images over the Intranet and Internet for remote monitoring. The DCS-7000L allows remote access using a Web browser for live image viewing, and allows the administrator to manage and control the DCS-7000L anytime, anywhere in the world. Many applications exist, including industrial and public monitoring of homes, offices, banks, hospitals, child-care centers, and amusement parks.

### **802.11ac Wireless or Ethernet/Fast Ethernet Support**

The DCS-7000L offers wireless 802.11ac and Ethernet/Fast Ethernet connectivity, making the DCS-7000L easy to integrate into your existing network environment. The DCS-7000L works with 10/100 Mbps Ethernet based networks for traditional wired environments, and works with 802.11ac routers or access points for added flexibility. The Site Survey feature also allows you to view and connect to any available wireless networks.

### **Remote Monitoring Utility**

The D-ViewCam application adds enhanced features and functionality for the DCS-7000L and allows administrators to configure and access the DCS-7000L from a remote site via Intranet or Internet. Other features include image monitoring, recording images to a hard drive, viewing up to 32 cameras on one screen, and taking snapshots.

# Hardware Overview

## Front

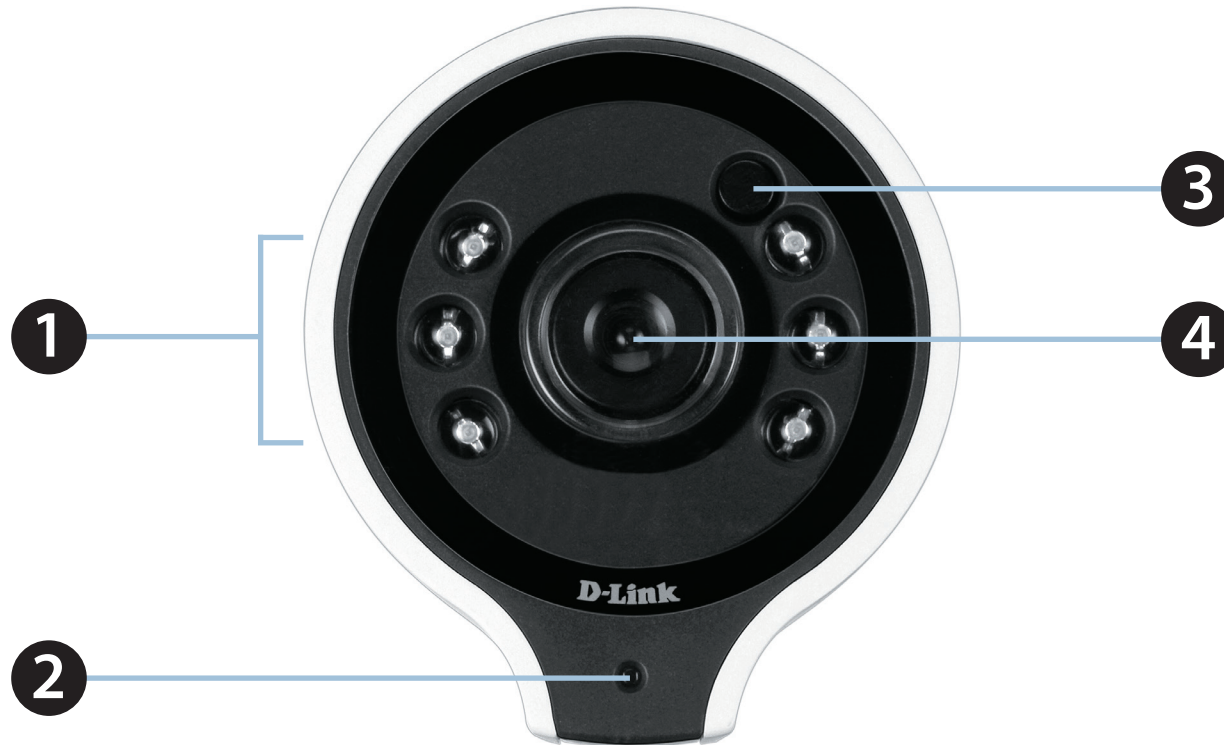

1	<b>IR LEDs</b>	Used to illuminate the camera's field of view at night
2	<b>Power/Link LED</b>	Indicates the camera's current status
3	<b>Light Sensor</b>	Measures the lighting conditions and switches between color and infrared accordingly.
4	<b>Camera Lens</b>	Records video of the surrounding area



## Rear

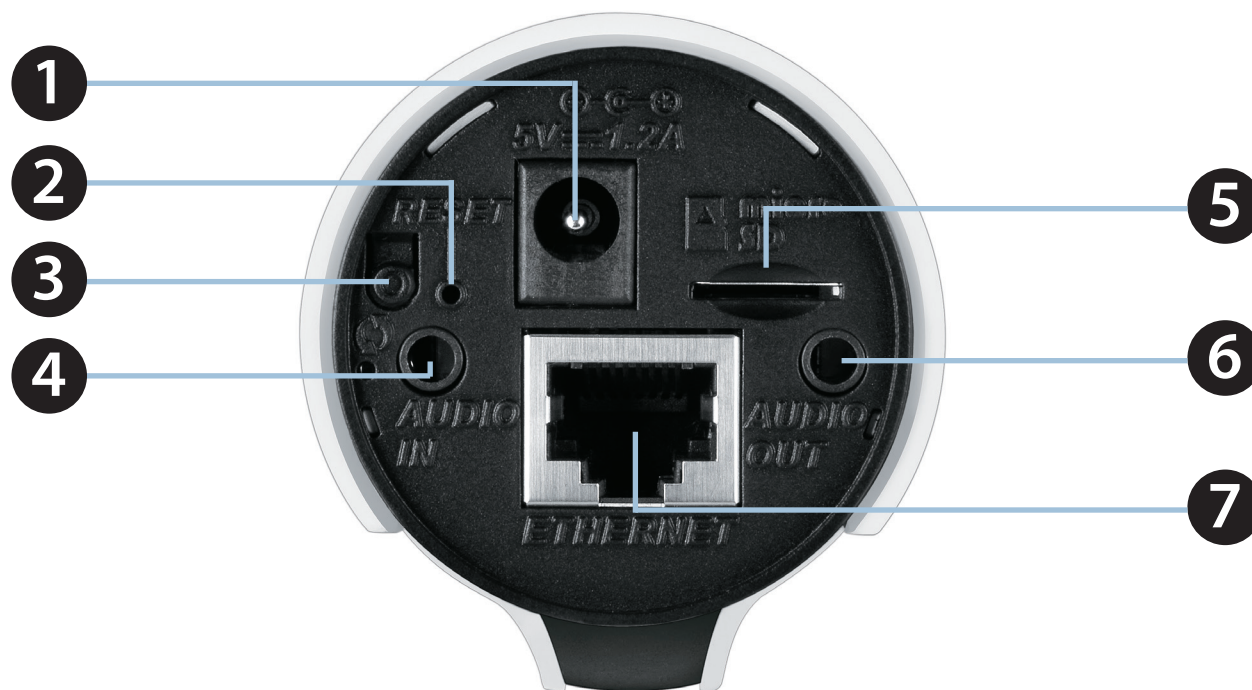

1	<b>Power Connector</b>	Connects to the included DC 5 V power adapter
2	<b>Reset Button</b>	Press and hold this button for 10 seconds to reset the camera
3	<b>WPS Button</b>	Press this button for 3 seconds, then within the next 60 seconds press the WPS button on your router to set up a wireless connection automatically
4	<b>Audio In</b>	Connect an audio jack to override the built-in audio input
5	<b>microSD Card Slot</b>	Insert a microSD or microSDHC card to store recordings (max. capacity 32 GB)
6	<b>Audio Out</b>	Connect an audio jack for audio output
7	<b>Ethernet Port</b>	RJ45 connector for Ethernet

## Adjusting Camera Focus

Use the included focus adjustment tool to adjust the camera focus by rotating the circular frame around the lens clockwise or anti-clockwise.

**Note:** For fine tuning the focus, it is recommended to use the included focus adjustment tool rather than attempting to adjust the lens with your fingers or other objects.



# Software Installation

There are three ways to set up your camera:

**Zero Configuration Setup:** If you have a mydlink-enabled router, this is the easiest way to set up your camera. Refer to page 12.

**Camera Setup Wizard:** If you do not have a mydlink-enabled router, use the Camera Installation Wizard to guide you through setup and initial configuration of your camera. Refer to page 16.

**Manual Hardware Installation:** This section shows you how to manually set up your camera, though in order to use the mydlink features of your camera, you will still need to run the Camera Installation Wizard. Refer to page 18.

## Zero Configuration Setup

If you have a D-Link Cloud Router, you can take advantage of Zero Configuration. Zero Configuration automatically configures your camera's settings for you, and adds it to your mydlink account automatically. This type of setup allows you to set up your camera by simply plugging it in and connecting it to your router.

Connect your camera to your mydlink enabled cloud router and Zero Configuration will automatically configure your DCS-7000L and automatically add the camera to your mydlink account. You can now remotely access your camera from the mydlink.com website to manage and monitor your DCS-7000L.

### Connect the Ethernet Cable

If using an Ethernet connection: Connect the included Ethernet cable to the Ethernet port located on the back of the DCS-7000L and connect it to your router.

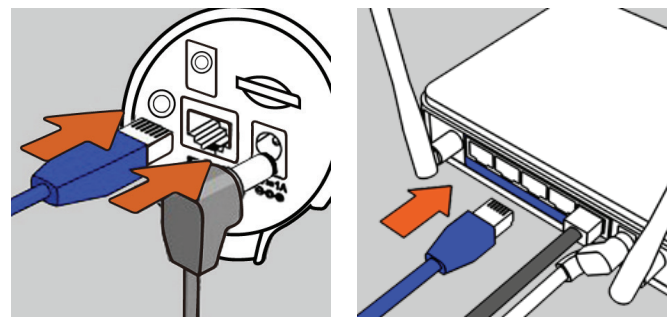

### Attach the External Power Supply

Attach the external power supply to the DC Power receptor located on the rear panel of the DCS-7000L and connect it to your wall outlet or power strip.

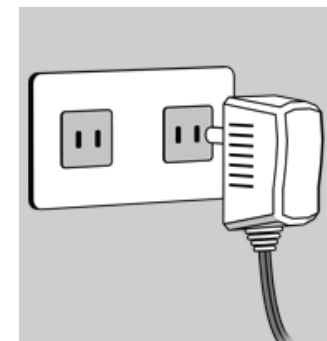

## Optional: WPS Wireless Connection

Alternatively, if your router supports WPS, you can use the WPS button on the camera to easily create a secure wireless connection to your network.

### To create a WPS connection:

#### Step 1

Press and hold the WPS button for approximately 5-6 seconds. The blue WPS status LED above the button will blink.

#### Step 2

Within 60 seconds press the WPS button on your router. On some routers, you may need to log in to the web interface and click on an on-screen button to activate the WPS feature. If you are not sure where the WPS button is on your router, please refer to your router's User Manual.

The DCS-7000L will automatically create a wireless connection to your router. While connecting, the status LED will flash. When the connection process is complete, the status LED will turn solid.

**Note:** If your router does not support WPS, you can still use the wired connection method on the previous page. After Zero Configuration setup is complete, your router's wireless settings will be automatically transferred to the camera.

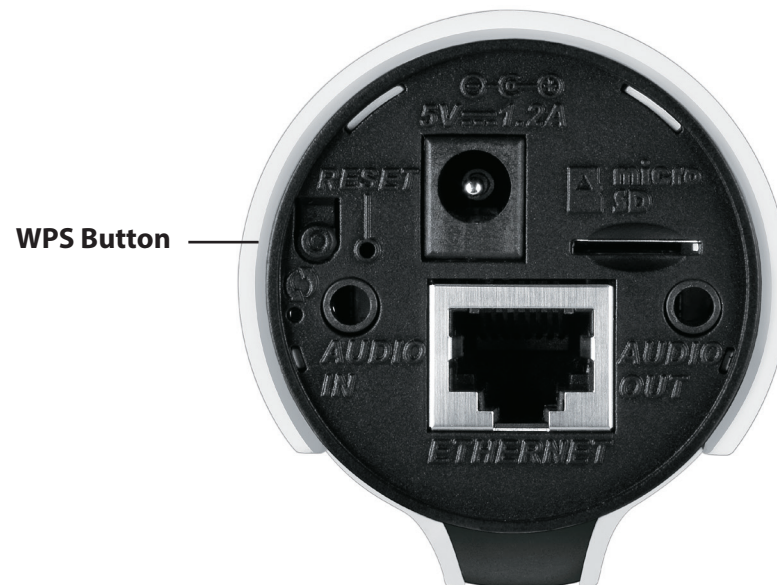

## Check Your mydlink Account

From any computer, open a web browser, go to <http://www.mydlink.com> and log into your account. Once mydlink detects your camera, a **New Device Found!** notice will appear in the bottom-left corner. Click on the device name to continue.

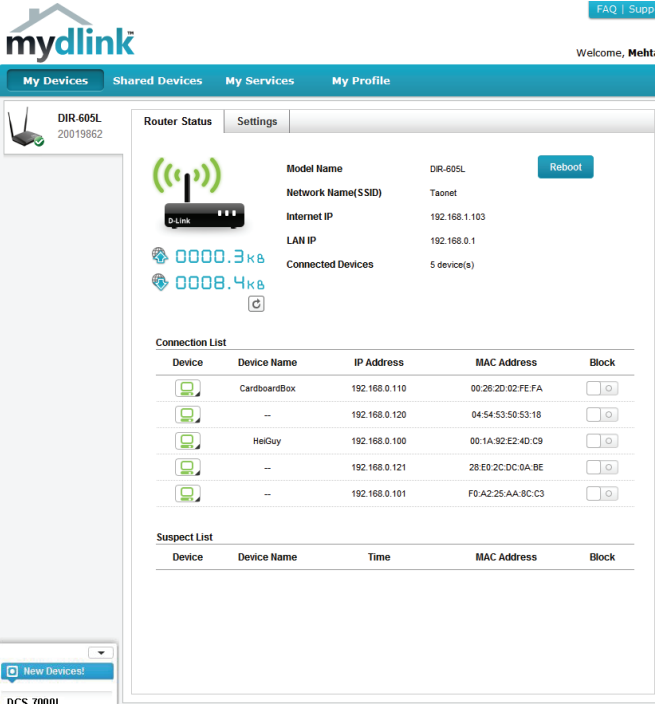

The screenshot shows the mydlink web interface. At the top, there's a navigation bar with "My Devices", "Shared Devices", "My Services", and "My Profile". The user is logged in as "Mehta P". The main content area is titled "Router Status" and "Settings" for a DIR-605L router. It displays various network details: Model Name (DIR-605L), Network Name (SSID) (Taonet), Internet IP (192.168.1.103), LAN IP (192.168.0.1), and Connected Devices (5 device(s)). There are also data usage indicators for 0000.3kB and 0008.4kB. Below this is a "Connection List" table with columns for Device, Device Name, IP Address, MAC Address, and Block. The table lists several devices, including "CardboardBox", "HeiGuy", and others. At the bottom left, a "New Devices" notification is visible, listing "DCS-7000L".

A summary and confirmation notification will appear with the automatically configured details. Make a note of the details and click **Yes** to add the camera to your account.

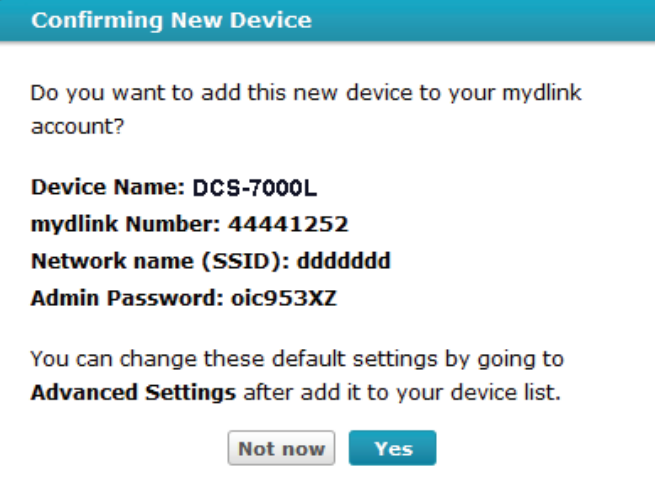

The screenshot shows a "Confirming New Device" dialog box. It asks, "Do you want to add this new device to your mydlink account?". Below the question, the following details are listed:

- Device Name: DCS-7000L**
- mydlink Number: 44441252**
- Network name (SSID): dddddd**
- Admin Password: oic953XZ**

Below the details, it says: "You can change these default settings by going to **Advanced Settings** after add it to your device list." At the bottom, there are two buttons: "Not now" and "Yes".

## Section 2: Installation

Zero Configuration is now complete and your camera has been added to your mydlink account. You can now view your camera on the mydlink Live View tab.

If you wish to connect your camera to your router wirelessly, you can simply disconnect the Ethernet cable and move the camera to its intended location; your router's wireless settings have been automatically transferred to the camera, and no further configuration is required.

Your camera is now set up, and you can skip to "mydlink" on page 21 to learn more about the mydlink features of this camera, or to "Configuration" on page 22 for advanced configuration of your camera.

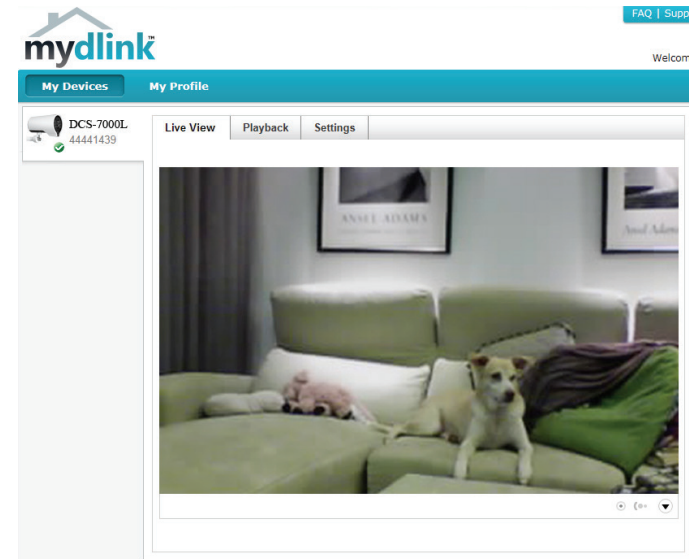

# Camera Setup Wizard

If you do not have a mydlink-enabled Cloud Router, you can use the Camera Setup Wizard to guide you through the process of adding your camera to the mydlink service.

## Windows Users

Insert the Installation CD-ROM into your computer's optical drive to start the autorun program. If the autorun program does not open, go to My Computer, browse to your CD drive, and double-click on the autorun.exe file. Once the wizard has started simply click **Set up your Cloud Camera** to go through the Setup Wizard, which will guide you step-by-step through the installation process from connecting your hardware to configuring your camera and registering it with your mydlink account.





## Mac Users

Insert the Installation CD-ROM into your computer's optical drive. On the desktop, open your CD drive and double-click on the **SetupWizard** file.



After about 20-30 seconds, the Setup Wizard will open, which will guide you step-by-step through the installation process from connecting your hardware to configuring your camera and registering it with your mydlink account.

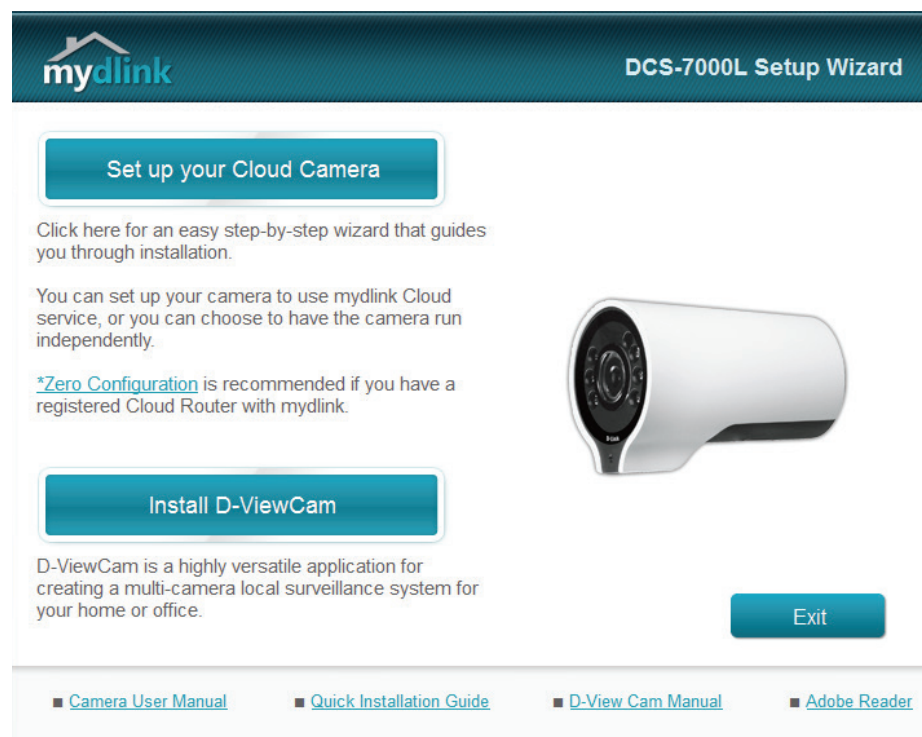

## Manual Hardware Installation

If you wish to set up your camera without using the Camera Setup Wizard, please follow these steps.

**Note:** In order to use the mydlink features of this product, you will need to go through the Camera Setup Wizard.

### Attach the External Power Supply

Attach the external power supply to the DC Power receptor located on the rear panel of the DCS-7000L and connect it to your wall outlet or power strip.

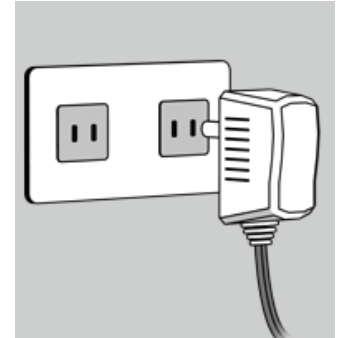

### Connect the Ethernet Cable

Connect the included Ethernet cable to the network cable connector located on the panel at the rear of the DCS-7000L and attach it to the network.

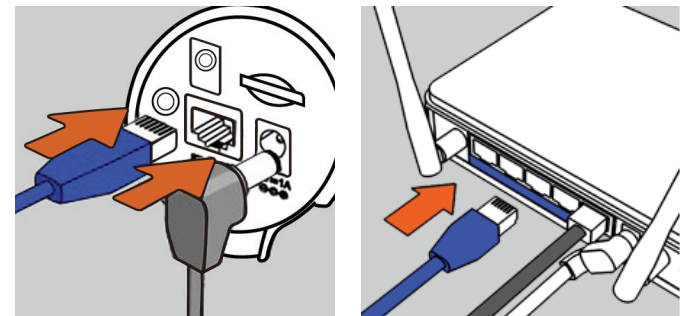

# Installation

## Wireless Installation Considerations

This D-Link device can connect to your wireless network from anywhere within the operating range of your wireless network. However, the number, thickness and location of walls, ceilings, or other objects that the wireless signals must pass through, may limit the range. Typical ranges vary depending on the types of materials and background RF (radio frequency) noise in your home or business. The key to maximizing wireless range is to follow these basic guidelines:

1. Minimize the number of walls and ceilings between your adapter and other network devices (such as your DCS-7000L) - each wall or ceiling can reduce your adapter's range from 3-90 feet (1-30 meters).
2. Be aware of the direct line between network devices. A wall that is 1.5 feet thick (.5 meters), at a 45-degree angle appears to be almost 3 feet (1 meter) thick. At a 2-degree angle, it looks over 42 feet (14 meters) thick. Position your devices so that the signal will travel straight through a wall or ceiling (instead of at an angle) for better reception.
3. Building materials make a difference. A solid metal door or aluminum studs may weaken the wireless signal. Try to position your access points, wireless routers, and other networking devices where the signal passes through drywall or open doorways. Materials and objects such as glass, steel, metal, walls with insulation, water (fish tanks), mirrors, file cabinets, brick, and concrete will degrade your wireless signal.
4. Keep your product at least 3-6 feet or 1-2 meters away from electrical devices or appliances that generate RF noise.
5. If you are using 2.4 GHz cordless phones or other radio frequency sources (such as microwave ovens), your wireless connection may degrade dramatically or drop completely. Make sure your 2.4 GHz phone base is as far away from your wireless devices as possible. The base transmits a signal even if the phone is not in use.

## WPS - Push Button Setup

If your router supports WPS, you can use the WPS button on the camera to easily create a secure wireless connection to your network.

### To create a WPS connection:

#### Step 1

Press and hold the WPS button for approximately 5-6 seconds. The blue WPS status LED above the button will blink.

#### Step 2

Within 60 seconds press the WPS button on your router. On some routers, you may need to log in to the web interface and click on an on-screen button to activate the WPS feature.

The DCS-7000L will automatically create a wireless connection to your router. While connecting, the status LED will flash. When the connection process is complete, the status LED will turn solid.

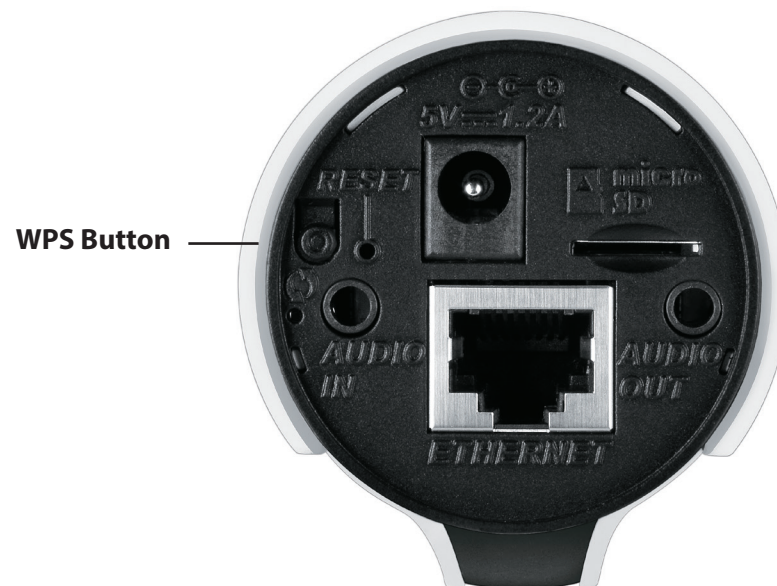

# mydlink

After registering your DCS-7000L camera with a **mydlink** account in the Camera Setup Wizard. You will be able to remotely access your camera from the [www.mydlink.com](http://www.mydlink.com) website. After signing in to your **mydlink** account, you will see a screen similar to the following:

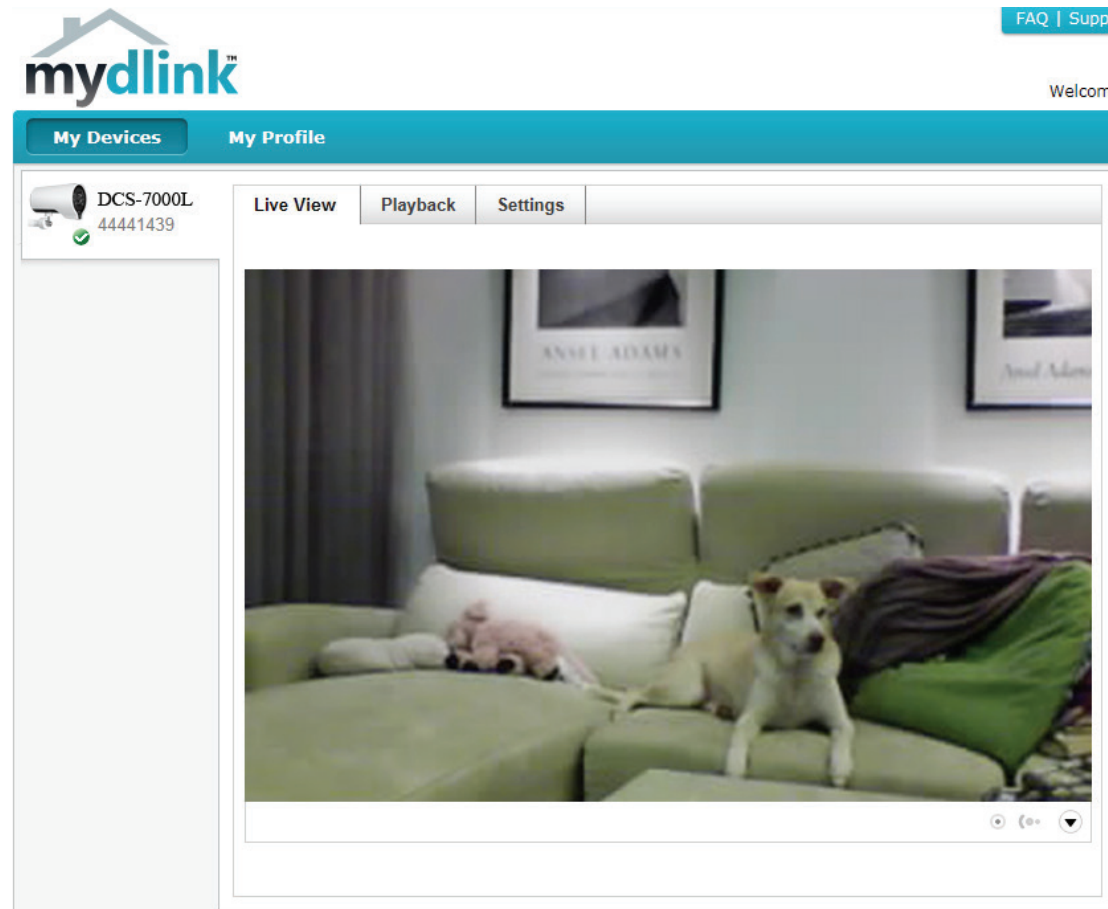

For more details on using your camera with mydlink, go to the **Support** section of the mydlink website and check the **User Manual** section for your product to find the latest instruction guide for your camera's mydlink features.

# Configuration

After completing the Camera Installation Wizard, you are ready to use your camera. The camera's built-in Web configuration interface is designed to allow you to easily access and configure your DCS-7000L. At the end of the wizard, enter the IP address of your camera into a web browser, such as Internet Explorer®. To log in, use the User name **admin** and the password you created during the setup process. If you did not create a password, the default password is blank. After entering your password, click **OK**.

**Note:** If you are directly connecting your PC to the camera, or if you are using the camera on a closed network, the default IP is **192.168.0.20**.







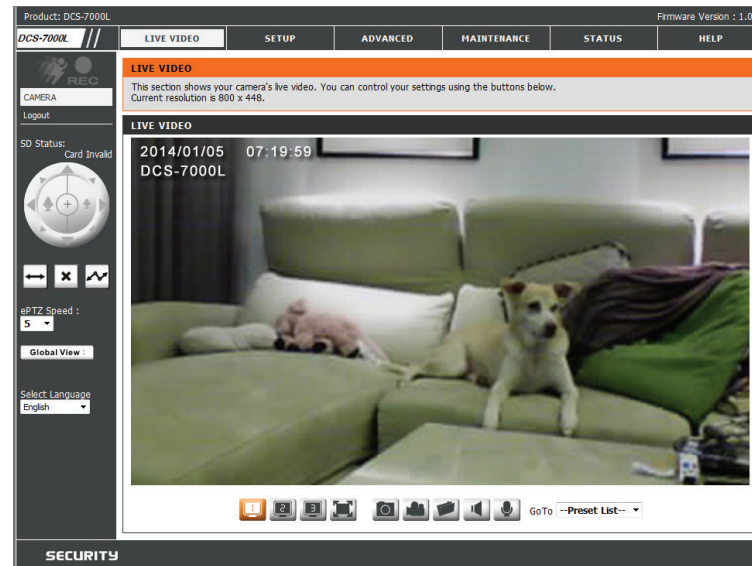

## Live Video

This section shows your camera's live video. You may select any of the available icons listed below to operate the camera. You may also select your language using the drop-down menu on the left side of the screen.

You can zoom in and out on the live video image using your mouse. Right-click to zoom out or left-click to zoom in on the image.

**SD Status:** This option displays the status of the SD card. If no SD card has been inserted, this screen will display the message "Card Invalid."



	<b>Motion Trigger Indicator</b>	This indicator will change color when a trigger event occurs. <b>Note:</b> The video motion feature for your camera must be enabled.
	<b>Recording Indicator</b>	When a recording is in progress, this indicator will change color.
	<b>Control Pad</b>	This control pad can be used to electronically pan, tilt, and zoom (ePTZ) within the camera's predefined view area, if one has been defined.
	<b>Auto Pan</b>	Starts the automatic panning function. The ROI will pan from back and forth within the FOV
	<b>Stop</b>	Stops automatic panning.
	<b>Preset Path</b>	Starts the camera's motion along the predefined path.









## Section 4: Configuration

**ePTZ Speed:** You may select a value between 0 and 64. 0 is the slowest and 64 is the fastest.

**Global View:** This window indicates the total field of view (FOV) of the camera. The red box indicates the visible region of interest (ROI).

**Language:** You may select the interface language using this menu.

**Go To:** If any presets have been defined, selecting a preset **(Preset List)** from this list will display it.

-  Video Profile 1
-  Video Profile 2
-  Video Profile 3
-  Full screen mode
-  Taking a Snapshot
-  Record a Video Clip
-  Set a Storage Folder
-  Listen/Stop Audio In (from microphone)
-  Start/Stop Audio Out (to speaker)

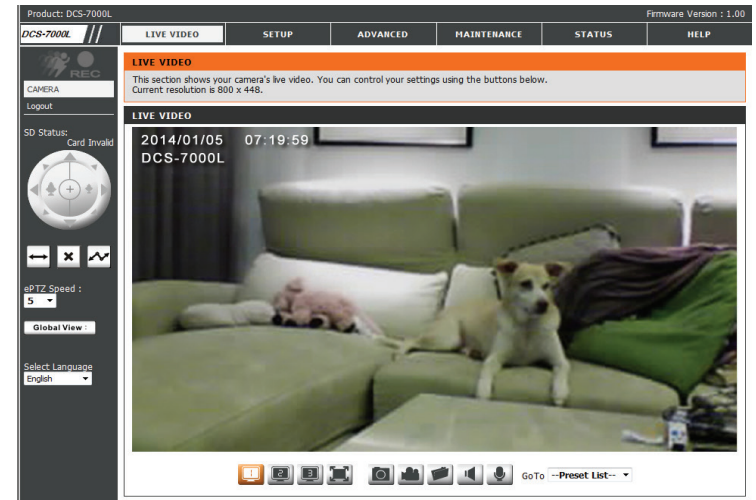



# Setup Setup Wizard

This section allows you to begin setup wizards which will guide you through the process of getting your camera's various functions configured. If you comfortable with adjusting the settings manually, you may skip the wizards and adjust the necessary as needed.

**Internet Connection Setup Wizard:** You may choose to configure your network by using the Internet Connection Setup Wizard that includes step-by-step instructions. Please refer to page "Internet Connection Setup Wizard" on page 26 for more details.

**Manual Internet Connection Setup:** If you would rather manually setup the camera internet connection, you can refer to page "Network Setup" on page 31 which provides more details on the information required.

**Motion Detection Setup Wizard:** You may choose to configure motion detection by using the Motion Detection Setup Wizard that includes step-by-step instructions. Please refer to page "Motion Detection Setup Wizard" on page 29 for more details.

**Manual Motion Detection Setup:** If you would rather manually setup the camera's motion detection features, you can refer to page "Motion Detection" on page 42 which provides more details on the information required.

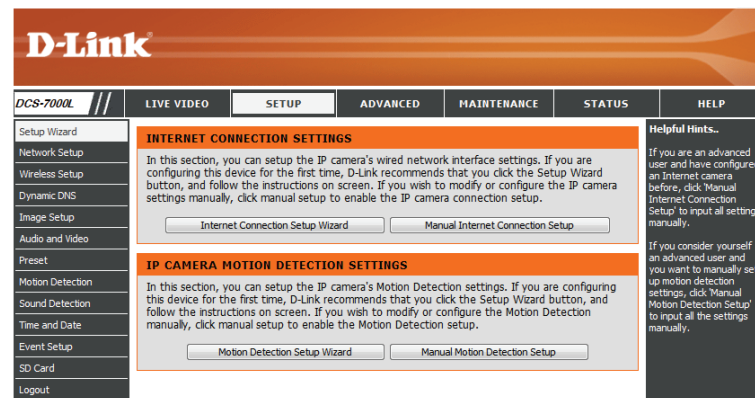

## Internet Connection Setup Wizard

This wizard will guide you through a step-by-step process to configure your new D-Link Camera and connect the camera to the Internet. **Note that this wizard will not register your camera with mydlink.com.**

Click **Next** to continue.

Select **Automatic IP Address** if you want your DHCP server (usually enabled on your router) to assign the camera its IP settings. If you want to manually assign the IP settings, select **Static IP Address** and enter the following details:

**IP Address:** Enter an IP address for your camera.

**Subnet Mask:** Enter the subnet mask of your network.

**Default Gateway:** Enter the default gateway address. This is usually the IP address of your router.

**Primary DNS:** Enter the primary DNS server's IP address. This is usually the IP address of your router.

**Secondary DNS:** Enter the secondary DNS server's IP address. This is optional.

If you are required to connect using PPPoE, select **Enabled** and enter the Username and Password for your PPPoE connection. Only select this option if your camera is directly connected to your broadband modem. If it is on a network with a router or gateway, do not select this option.

Click **Next** to continue.

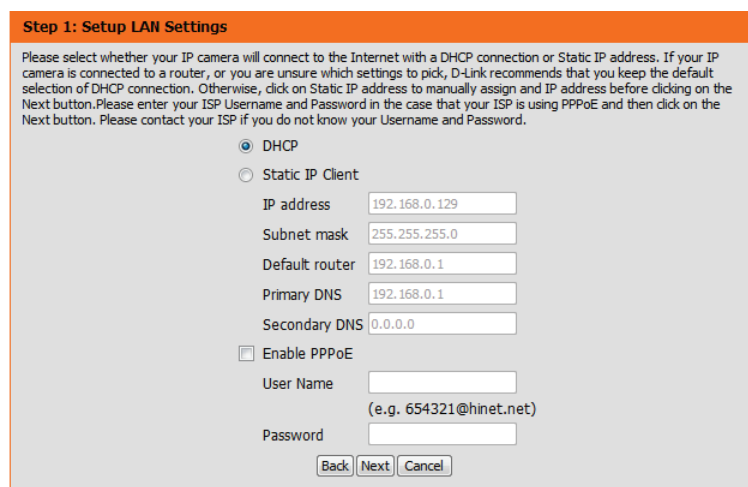
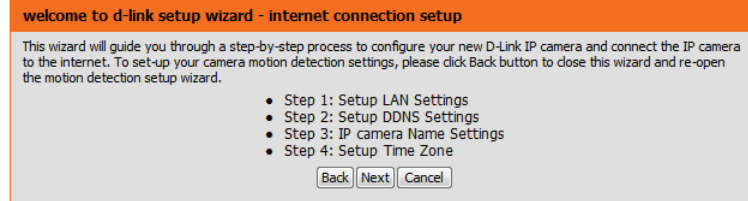

## Section 4: Configuration

A Dynamic DNS account allows you to access your camera over the Internet when you have an IP address that changes each time you connect to the Internet. If you have a Dynamic DNS account, click **Enable** and enter the following details:

**Enable:** Click to enable the DDNS function. The Dynamic Domain Name Server (DDNS) will hold a DNS host name and synchronize the public IP address of the modem when it has been modified. The username and password are required when using the DDNS service.

**Server Address:** Select your Dynamic DNS Server from the drop down menu.

**Host Name:** Enter the host name of the DDNS server.

**User Name:** Enter your username or e-mail address used to connect to the DDNS.

**Password:** Enter your password used to connect to the DDNS server.

**Verify Password:** Re-enter your password for verification.

**Timeout:** You can setup how often the camera notifies the DDNS server of its current global IP address by entering a whole number in hours.

Click **Next** to continue.

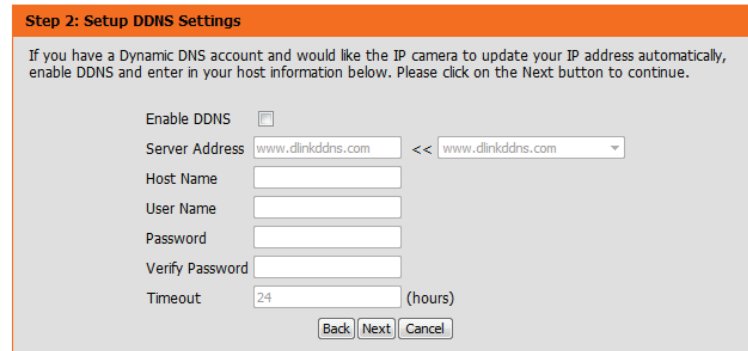

The screenshot shows a web interface for configuring DDNS settings. At the top, there is an orange header with the text "Step 2: Setup DDNS Settings". Below the header, a grey box contains the following text: "If you have a Dynamic DNS account and would like the IP camera to update your IP address automatically, enable DDNS and enter in your host information below. Please click on the Next button to continue." The form includes several fields: "Enable DDNS" with a checked checkbox, "Server Address" with a text input containing "www.dlinkddns.com" and a dropdown menu also showing "www.dlinkddns.com", "Host Name" with an empty text input, "User Name" with an empty text input, "Password" with an empty text input, "Verify Password" with an empty text input, and "Timeout" with a text input containing "24" and the label "(hours)". At the bottom right of the form are three buttons: "Back", "Next", and "Cancel".

## Section 4: Configuration

Create a unique name for your camera. Click **Next** to continue.

Select the time zone that the camera is geographically located in so that scheduled events occur at the correct time. If your time zone observes daylight saving, check the **Enable Daylight Saving** box.

Click **Next** to continue.

A summary of the options you selected is displayed for confirmation. If you are happy with the selected configuration, click **Apply** otherwise click **Back** to make the required changes.

### Step 3: IP camera Name Settings

D-Link recommends that you rename your IP camera for easy accessibility. You can then identify and connect to your IP camera via this name. Please assign a name of your choice before clicking on the Next button.

IP camera Name DCS-7000L

Back Next Cancel

### Step 4: Setup Time Zone

Please configure the correct time to ensure that all events are triggered, captured and scheduled at the correct time and day and then click on the Next button.

Time Zone (UTC-08:00) Pacific Time (US & Canada)

Enable Daylight Saving

Back Next Cancel

### Step 5: Setup complete

Below is a summary of your IP camera settings. Click on the Back button to review or modify settings or click on the Apply button if all settings are correct. It is recommended to note down these settings in order to access your IP camera on the network or via your web browser.

IP Address	DHCP
IP camera Name	DCS-7000L
Time Zone	(UTC-08:00) Pacific Time (US & Canada)
DDNS	Disable
PPPoE	Disable

Back Apply Cancel

## Motion Detection Setup Wizard

This wizard will guide you through a step-by-step process to configure your camera's motion detection functions.

Click **Next** to continue.

### Step 1

This step will allow you to enable or disable motion detection, specify the detection sensitivity, and adjust the camera's ability to detect movement.

You may specify whether the camera should capture a snapshot or a video clip when motion is detected.

Please see "Motion Detection" on page 42 for information about how to configure motion detection.

### Step 2

This step allows you to enable motion detection based on a customized schedule. Specify the day and hours. You may also choose to always record whenever motion is detected.

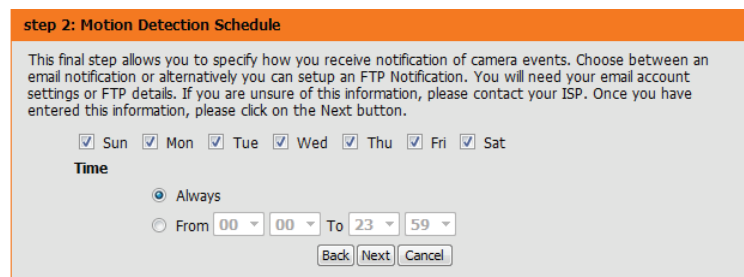
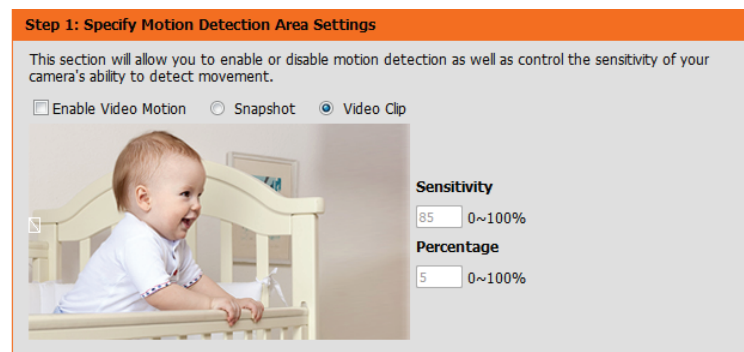
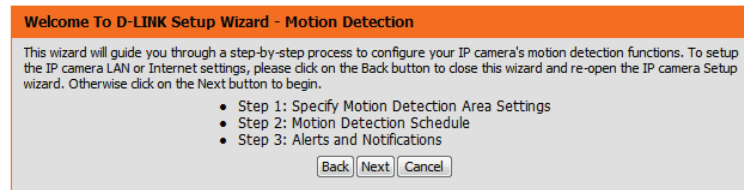

## Section 4: Configuration

### Step 3

This step allows you to specify how you will receive event notifications from your camera. You may choose not to receive notifications, or to receive notifications via e-mail or FTP.

Please enter the relevant information for your e-mail or FTP account.

Click **Next** to continue.

**Step 3: Alerts and Notification**

This final step allows you to specify how you receive notification of camera events. Choose between an email notification or alternatively you can setup an FTP Notification. You will need your email account settings or FTP details. If you are unsure of this information, please contact your ISP. Once you have entered this information, please click on the Next button.

Do not notify me

Email

Sender email address

Recipient email address

Server address

User name

Password

Port

FTP

Server address

Port

User name

Password

Remote folder name

### Step 4

You have completed the Motion Detection Wizard.

Please verify your settings and click **Apply** to save them.

**Step 4: Setup Complete**

You have completed your IP camera setup. Please click the Back button if you want to review or modify your settings or click on the Apply button to save and apply your settings.

Motion Detection : Disable

EVENT : Video Clip

Schedule Day : Sun , Mon , Tue , Wed , Thu , Fri , Sat ,

Schedule Time : Always

Alerts and Notification : Do not notify me

Please wait a few moments while the camera saves your settings and restarts.

# Network Setup

Use this section to configure the network connections for your camera. All relevant information must be entered accurately. After making any changes, click the **Save Settings** button to save your changes.

**DHCP:** Select this connection if you have a DHCP server running on your network and would like your camera to obtain an IP address automatically.

**Static IP Address:** You may obtain a static or fixed IP address and other network information from your network administrator for your camera.

**IP Address:** Enter the fixed IP address in this field.

**Subnet Mask:** This number is used to determine if the destination is in the same subnet. The default value is 255.255.255.0.

**Default Gateway:** The gateway used to forward data to.

**Primary DNS:** The primary domain name server translates names to IP addresses.

**Secondary DNS:** The secondary DNS acts as a backup to the primary.

**Enable UPnP Presentation:** Enabling this setting allows your camera to be configured as a UPnP device on your network.

**Enable UPnP Port Forwarding:** Enabling this setting allows the camera to specify a port to forward for remote UPnP connections.

**Forwarding Port:** Enter the UPnP port you wish to forward, and click **Test** to check whether it is available.

**Forwarding Status:** Displays the current UPnP port forwarding status.

**D-Link**

DCS-7000L // LIVE VIDEO SETUP ADVANCED MAINTENANCE STATUS HELP

Setup Wizard  
 Network Setup  
 Wireless Setup  
 Dynamic DNS  
 Image Setup  
 Audio and Video  
 Preset  
 Motion Detection  
 Sound Detection  
 Time and Date  
 Event Setup  
 SD Card  
 Logout

**NETWORK SETUP**  
 You can configure your LAN and Internet settings here.  
 Save Settings Don't Save Settings

**LAN SETTINGS**

DHCP  
 Static IP Client

IP address 192.168.0.129  
 Subnet mask 255.255.255.0  
 Default router 192.168.0.1  
 Primary DNS 192.168.0.1  
 Secondary DNS 0.0.0.0

Enable UPnP presentation  
 Enable UPnP port forwarding

Forwarding Port 1024 Test  
 Forwarding Status UPnP forwarding is inactive

**PPPOE SETTINGS**

Enable  Disable

User Name  
 Password  
 Confirm password  
 PPPoE Status PPPoE is inactive.

**HTTP**

HTTP port 80  
 Access name for stream1 video1.mjpg  
 Access name for stream2 video2.mjpg  
 Access name for stream3 video3.mjpg

**HTTPS**

HTTPS port 443

**RTSP**

Authentication Digest  
 RTSP port 554  
 Access name for stream1 live1.sdp  
 Access name for stream2 live2.sdp  
 Access name for stream3 live3.sdp

**COS SETTINGS**

Enable CoS

VLAN ID 1 [0-4095]  
 Live video 0  
 Live audio 0  
 Event/Alarm 0  
 Management 0

**QoS SETTINGS**

Enable QoS

Live video 0  
 Live audio 0  
 Event/Alarm 0  
 Management 0

**Helpful Hints...**

Select DHCP ConnectionIf you are running a DHCP server on your network and would like an IP address assigned to your IP camera automatically.

**UPnP:** Enabling UPnP settings will allow you to configure your IP camera as an UPnP device in the network.

**PPPoE Setting:** If you use the IP camera to connect directly to the Internet, you will need to enter the username and password, which were given to you when you set up your account with your Internet Service Provider. If the camera is behind a router or a gateway, you do not need to configure this setting.

**HTTP:** HTTP Port is the port you allocate in order to connect to the IP camera via a standard web browser.

**HTTPS:** HTTPS Port is a IP camera connects it with a PC via a secure web browser.

**RTSP:** RTSP Port is the port you allocate in order to connect to a IP camera by using streaming mobile device(s), such as a mobile phone or PDA.

**CoS (Class of Service):** Coarsely-grained traffic control based on the L2 protocol. Class of Service technologies do not guarantee a level of service in terms of bandwidth and delivery time, they offer a "best-effort".

**QoS (Quality of Service):** Finely-grained traffic control, a resource reservation control mechanism. Quality of service guarantees are important if the network capacity is insufficient, especially for real-time streaming multimedia applications.

**Enable IPv6:** Select this option and click Save to enable IPv6 setting. Please note that this only works if your network environment and hardware equipment support IPv6. The browser should be Microsoft @ Internet Explorer 6.5, Mozilla Firefox 3.0 or above. When IPv6 is enabled, by default, the Network Camera will listen to router advertisements and be assigned a link-local IPv6 address accordingly.

**IPv6 Information:** Click this button to obtain the IPv6 information. If your IPv6 setting are successful, the IPv6 address list will be listed in the status window.

**Enable PPPoE:** Enable this setting if your network uses PPPoE.

**User Name / Password:** Enter the username and password for your PPPoE account. Re-enter your password in the Confirm Password field. You may obtain this information from your ISP.

**HTTP Port:** The default port number is 80.

**Access Name for Stream 1~3:** The default name is video#.mjpg, where # is the number of the stream.

**HTTPS Port:** You may use a PC with a secure browser to connect to the HTTPS port of the camera. The default port number is 443.

**RTSP Port:** The port number that you use for RTSP streaming to mobile devices, such as mobile phones or PDAs. The default port number is 554. You may specify the address of a particular stream. For instance, live1.sdp can be accessed at rtsp://x.x.x.x/video1.sdp where the x.x.x.x represents the ip address of your camera.

**Enable CoS:** Enabling the Class of Service setting implements a best-effort policy without making any bandwidth reservations.

**Enable QoS:** Enabling QoS allows you to specify a traffic priority policy to ensure a consistent Quality of Service during busy periods. If the DCS-7000L is connected to a router that itself implements QoS, the router's settings will override the QoS settings of the camera.

**Enable IPv6:** Enable the IPv6 setting to use the IPv6 protocol. Enabling the option allows you to manually set up the address, specify an optional IP address, specify an optional router and an optional primary DNS.

The screenshot displays the configuration page for the D-Link DCS-7000L camera, organized into several sections:

- HTTP:** HTTP port is set to 80. Access names for streams 1, 2, and 3 are video1.mjpg, video2.mjpg, and video3.mjpg.
- HTTPS:** HTTPS port is set to 443.
- RTSP:** Authentication is set to Digest. RTSP port is 554. Access names for streams 1, 2, and 3 are live1.sdp, live2.sdp, and live3.sdp.
- COS SETTINGS:** Enable CoS is checked. VLAN ID is 1. Live video, audio, Event/Alarm, and Management are all set to 0.
- QOS SETTINGS:** Enable QoS is checked. Live video, audio, Event/Alarm, and Management are all set to 0.
- IPv6:** Enable IPv6 is checked. An IPv6 Information button is present. Below it, fields for manually setting the IP address, optional IP address/prefix length, optional default router, and optional primary DNS are shown.
- MULTICAST:** This section allows enabling multicast for streams 1, 2, and 3. For each stream, fields for Multicast group address, video port, RTCP video port, audio port, RTCP audio port, and TTL [1~255] are provided.

At the bottom of the page, there are "Save Settings" and "Don't Save Settings" buttons.

**HTTP:** Port number that you allocate in order to connect to a IP camera by using streaming mobile device(s), such as a mobile phone or PDA.

**CoS (Class of Service):** Coarsely-grained traffic control based on the L2 protocol. Class of Service technologies do not guarantee a level of service in terms of bandwidth and delivery time; they offer a "best-effort".

**QoS (Quality of Service):** Finely-grained traffic control, a resource reservation control mechanism. Quality of service guarantees are important if the network capacity is insufficient, especially for real-time streaming multimedia applications.

**Enable IPv6:** Select this option and click Save to enable IPv6 setting. Please note that this only works if your network environment and hardware equipment support IPv6. The browser should be Microsoft® Internet Explorer 6.5, Mozilla Firefox 3.0 or above. When IPv6 is enabled, by default, the Network Camera will listen to router advertisements and be assigned a link-local IPv6 address accordingly.

**IPv6 Information:** Click this button to obtain the IPv6 information. If your IPv6 setting are successful, the IPv6 address list will be listed in the pop-up window. Please follow the steps below to link to an IPv6 address.  
 1) Open your web browser.  
 2) Enter the link-global or link-local IPv6 address in the address bar of your web browser.  
 3) Press Enter on the keyboard or click Refresh button to refresh the webpage.

**Manually setup the IP address:** Select this option to manually configure IPv6 setting if your network environment does not have DHCPv6 server and advertisements-enabled routers.

**Multicast:** Click the items to display the detailed configuration information. Select the Always multicast option to enable multicast for stream 1 ~ 3. Unicast video transmission delivers a stream through point-to-point transmission; multicast, on the other hand, sends a stream to the multicast group address and allows multiple clients to acquire the stream at the same time by requesting a copy from the multicast group address. Therefore, enabling multicast can effectively save network bandwidth.

**Multicast RTP video, audio port/Multicast RTCP video, audio port:** The ports can be changed to values between 1024 and 65534. The multicast RTP port must be an even number and the multicast RTCP port number is the multicast RTP port number plus one, and



**Enable Multicast for stream** The DCS-7000L allows you to multicast each of the available streams via group address and specify the TTL value for each stream. Enter the port and TTL settings you wish to use if you do not want to use the defaults.

Please verify your settings and click **Save Settings** to commit them.

**MULTICAST**

Enable multicast for stream 1

Multicast group address: 239.1.1.1

Multicast video port: 6550

Multicast RTP video port: 6551

Multicast audio port: 6552

Multicast RTP audio port: 6553

Multicast TTL [1~255]: 64

Enable multicast for stream 2

Multicast group address: 239.1.1.2

Multicast video port: 6554

Multicast RTP video port: 6555

Multicast audio port: 6556

Multicast RTP audio port: 6557

Multicast TTL [1~255]: 64

Enable multicast for stream 3

Multicast group address: 239.1.1.3

Multicast video port: 6558

Multicast RTP video port: 6559

Multicast audio port: 6560

Multicast RTP audio port: 6561

Multicast TTL [1~255]: 64

**Manually setup the IP address:** Select this option to manually configure IPv6 setting if your network environment does not have DHCPv6 server and advertisements-enabled routers.

**Multicast:** Click the items to display the detailed configuration information. Select the Always multicast option to enable multicast for stream 1 ~ 3. Unicast video transmission delivers a stream through point-to-point transmission; multicast, on the other hand, sends a stream to the multicast group address and allows multiple clients to acquire the stream at the same time by requesting a copy from the multicast group address. Therefore, enabling multicast can effectively save network bandwidth.

**Multicast RTP video, audio port/Multicast RTP video, audio port:** The ports can be changed to values between 1024 and 65534. The multicast RTP port must be an even number and the multicast RTP port number is the multicast RTP port number plus one, and

## Wireless Setup

This section allows you to set up and configure the wireless settings on your camera. After making any changes, click the **Save Settings** button to save your changes.

**Site Survey:** Click the **Rescan** button to scan for available wireless networks. After scanning, you can use the drop-down box to select an available wireless network. The related information (SSID, Wireless Mode, Channel, Authentication, Encryption) will be automatically filled in for you.

**SSID:** Enter the SSID of the wireless access point you wish to use.

**Wireless Mode:** Use the drop-down box to select the mode of the wireless network you wish to connect to. Infrastructure is normally used to connect to an access point or router. Ad-Hoc is usually used to connect directly to another computer.

**Channel:** If you are using Ad Hoc mode, select the channel of the wireless network you wish to connect to, or select **Auto**.

**Authentication:** Select the authentication you use on your wireless network - **Open**, **Shared**, **WPA-PSK**, or **WPA2-PSK**.

**Encryption:** If you use WPA-PSK or WPA2-PSK authentication, you will need to specify whether your wireless network uses TKIP or AES encryption. If you use Open or Shared authentication, WEP encryption should be the setting.

**Key:** If you use WEP, WPA-PSK, or WPA2-PSK authentication, enter the Key (also known as password) used for your wireless network.

The screenshot shows the D-Link web interface for the DCS-7000L camera. The top navigation bar includes 'LIVE VIDEO', 'SETUP', 'ADVANCED', 'MAINTENANCE', 'STATUS', and 'HELP'. The 'SETUP' menu is expanded, showing options like 'Setup Wizard', 'Network Setup', 'Wireless Setup', 'Dynamic DNS', 'Image Setup', 'Audio and Video', 'Preset', 'Motion Detection', 'Sound Detection', 'Time and Date', 'Event Setup', 'SD Card', and 'Logout'. The 'Wireless Setup' page is active, displaying the following configuration options:

- Enable Wireless:**
- Site Survey:**  **SSID List** (dropdown) **Rescan** button
- SSID:** default
- Wireless Mode:** Infrastructure
- Channel:** Auto
- Authentication:** Open
- Encryption:** Disable
- Default Key:** 1
- Key 1:** [password field]
- Key 2:** [password field]
- Key 3:** [password field]
- Key 4:** [password field]

Below the configuration fields are 'Save Settings' and 'Don't Save Settings' buttons. A 'Helpful Hints...' section on the right provides additional information:

- Helpful Hints...:** You may choose which wireless network for the connection using the pull-down menu of Site Survey or enter the SSID manually.
- SSID (Service Set Identifier):** is the name of your wireless network such as Default, Conference, My network, and etc.
- Authentication:**
  - Open:** This option makes the camera visible to all devices on the network. No encryption is provided.
  - Shared:** Allows communication only with other devices that have the identical WEP (Wired Equivalent Privacy) settings.
- WPA-PSK, WPA2-PSK:** Both modes will require you to input a pre-shared Key for the connection that is held between the camera and the wireless device.

## Dynamic DNS

DDNS (Dynamic Domain Name Server) will hold a DNS host name and synchronize the public IP address of the modem when it has been modified. A user name and password are required when using the DDNS service. After making any changes, click the **Save Settings** button to save your changes.

**Enable DDNS:** Select this checkbox to enable the DDNS function.

**Server Address:** Select your Dynamic DNS provider from the pull down menu or enter the server address manually.

**Host Name:** Enter the host name of the DDNS server.

**User Name:** Enter the user name or e-mail used to connect to your DDNS account.

**Password:** Enter the password used to connect to your DDNS server account.

**Timeout:** Enter the DNS timeout values you wish to use.

**Status:** Indicates the connection status, which is automatically determined by the system.

The screenshot shows the D-Link DCS-7000L web interface. The top navigation bar includes 'LIVE VIDEO', 'SETUP', 'ADVANCED', 'MAINTENANCE', 'STATUS', and 'HELP'. The left sidebar lists various setup options: Setup Wizard, Network Setup, Wireless Setup, Dynamic DNS (highlighted), Image Setup, Audio and Video, Preset, Motion Detection, Sound Detection, Time and Date, Event Setup, SD Card, and Logout. The main content area is titled 'DYNAMIC DNS' and contains the following text: 'The Dynamic DNS feature allows you to use a domain name that you have purchased (www.yourdomain.com) to access your IP camera with a dynamically assigned IP address. Most broadband Internet service providers assign dynamic (changing) IP addresses. By using a DDNS service, you can enter your domain name to connect to your IP camera no matter what your IP address is.' Below this text is a link: 'Sign up for D-Link's Free DDNS service at www.DLinkDDNS.com.' and two buttons: 'Save Settings' and 'Don't Save Settings'. The 'DYNAMIC DNS SETTING' section includes: 'Enable DDNS' (checkbox), 'Server Address' (text input with a dropdown menu), 'Host Name' (text input), 'User Name' (text input), 'Password' (text input), 'Verify Password' (text input), 'Timeout' (text input with '(hours)' label), and 'Status' (text input).

## Image Setup

In this section, you may configure the video image settings for your camera. A preview of the image will be shown in Live Video.

**Enable Privacy Mask:** The Privacy Mask setting allows you to specify up to 3 rectangular areas on the camera's image to be blocked/excluded from recordings and snapshots.

You may click and drag the mouse cursor over the camera image to draw a mask area. Right clicking on the camera image brings up the following menu options:

**Disable All:** Disables all mask areas

**Enable All:** Enables all mask areas

**Reset All:** Clears all mask areas.

**Anti Flicker:** If the video flickers, try enabling this setting.

**Mirror:** This will mirror the image horizontally.

**Flip:** This will flip the image vertically. When turning Flip on, you may want to consider turning Mirror on as well.

**Power Line:** Select the frequency used by your power lines to avoid interference or distortion.

**White Balance:** Use the drop-down box to change white balance settings to help balance colors for different environments. You can choose from **Auto**, **Outdoor**, **Indoor**, **Fluorescent**, and **Push Hold**.

The screenshot shows the D-Link DCS-7000L web interface. The top navigation bar includes 'LIVE VIDEO', 'SETUP', 'ADVANCED', 'MAINTENANCE', 'STATUS', and 'HELP'. The left sidebar lists various setup options, with 'Image Setup' selected. The main content area is titled 'IMAGE SETUP' and contains a 'LIVE VIDEO' section with a checkbox for 'Enable Privacy Mask Setting'. Below this is a live video preview showing a dog on a couch. The 'IMAGE SETTINGS' section includes the following controls:

- Anti Flicker: Radio buttons for On and Off (Off is selected).
- Mirror: Radio buttons for On and Off (Off is selected).
- Flip: Radio buttons for On and Off (Off is selected).
- Power Line: Radio buttons for 60 Hz and 50 Hz (60 Hz is selected).
- White Balance: A dropdown menu set to 'Auto'.
- Exposure Mode: A dropdown menu set to 'Auto' and a 'Max Gain' field set to '24' dB.
- Denoise: A dropdown menu set to '0'.
- Brightness: A dropdown menu set to '4'.
- Contrast: A dropdown menu set to '4'.
- Saturation: A dropdown menu set to '128'.
- Sharpness: A dropdown menu set to '4'.

A 'Reset Default' button is located at the bottom of the settings section. The 'Helpful Hints...' sidebar on the right provides detailed instructions for the Privacy Mask, Anti Flicker, Mirror, Flip, Power Line, White Balance, Exposure Mode, and Max Gain settings.

**Exposure Mode:** Changes the exposure mode. Use the drop-down box to set the camera for **Indoor**, **Outdoor**, or **Night** environments, or to **Moving** to capture moving objects. The **Low Noise** option will focus on creating a high-quality picture without noise. You can also create 3 different custom exposure modes. The **Max Gain** setting will allow you to control the maximum amount of gain to apply to brighten the picture.

**Denoise:** This setting controls the amount of noise reduction that will be applied to the picture.

**Brightness:** Adjust this setting to compensate for backlit subjects.

**Contrast:** Adjust this setting to alter the color intensity/strength.

**Saturation:** This setting controls the amount of coloration, from grayscale to fully saturated.

**Sharpness:** Specify a value from 0 to 8 to specify how much sharpening to apply to the image.

**Reset Default:** Click this button to reset the image to factory default settings.

The screenshot shows the D-Link DCS-7000L web interface. The top navigation bar includes 'LIVE VIDEO', 'SETUP', 'ADVANCED', 'MAINTENANCE', 'STATUS', and 'HELP'. The left sidebar lists various setup options, with 'Image Setup' selected. The main content area is divided into 'IMAGE SETUP' and 'IMAGE SETTINGS' sections.

**IMAGE SETUP**

Changes to your IP camera settings are made immediately.

**LIVE VIDEO**

Enable Privacy Mask Setting

The live video feed shows a dog sitting on a green sofa in a living room.

**IMAGE SETTINGS**

Anti Flicker	<input type="radio"/> On	<input checked="" type="radio"/> Off
Mirror	<input type="radio"/> On	<input checked="" type="radio"/> Off
Flip	<input type="radio"/> On	<input checked="" type="radio"/> Off
Power Line	<input checked="" type="radio"/> 60 Hz	<input type="radio"/> 50 Hz
White Balance	Auto	
Exposure Mode	Auto	Max Gain 24 dB
Denoise	0	
Brightness	4	
Contrast	4	
Saturation	128	
Sharpness	4	

Reset Default

**Helpful Hints...**

**Privacy Mask:** Click the attached box to activate this function. Now use your mouse to draw a rectangle covering the area you want hidden. Click the box again to deactivate the function.

**Anti Flicker:** This feature will help to offset the interference of the lighting system and avoid the image flicker issue. ONLY use this option when it is necessary.

**Mirror:** This function horizontally reverses your images 180 degrees.

**Flip:** This function vertically reverses your images 180 degrees.

**Power Line:** This setting is used to remove 50/60 Hz flicker.

**White Balance:** White Balance - Is the process of removing unrealistic color casts, so that objects which appear white in person are rendered white in your photo.

**Exposure Mode:** Exposure is the total amount of light allowed to fall on the image sensor during the process of capturing an image. You may choose different scene modes to produce the better images.

**Max Gain:** It can always

## Audio and Video

You may configure up to 3 video profiles with different settings for your camera. Hence, you may set up different profiles for your computer and mobile display. In addition, you may also configure the two-way audio settings for your camera. After making any changes, click the **Save Settings** button to save your changes.

**Number of active profiles:** You can use the drop-down box to set up to 2 active profiles.

**Aspect ratio:** Set the aspect ratio of the video to 4:3 standard or 16:9 widescreen.

**Mode:** Set the video codec to be used to JPEG, or H.264.

**Frame size / View window area:** Frame size determines the total capture resolution, and View window area determines the Live Video viewing window size. If the Frame size is larger than the Live Video size, you can use the ePTZ controls to look around.

**16:9** 1280 x 720, 800 x 448, 640 x 360, 480 x 272, 320 x 176

**4:3** 960 x 720, 800 x 592, 640 x 480, 480 x 352, 320 x 240

**Note:** If your View window area is the same as your Frame size, you will not be able to use the ePTZ function.

**Maximum frame rate:** A higher frame rate provides smoother motion for videos, and requires more bandwidth. Lower frame rates will result in stuttering motion, and requires less bandwidth.

The screenshot shows the D-Link DCS-7000L web interface. The main navigation bar includes tabs for LIVE VIDEO, SETUP, ADVANCED, MAINTENANCE, STATUS, and HELP. The left sidebar contains a menu with options like Setup Wizard, Network Setup, Wireless Setup, Dynamic DNS, Image Setup, Audio and Video (selected), Preset, Motion Detection, Sound Detection, Time and Date, Event Setup, SD Card, and Logout. The main content area is titled 'AUDIO AND VIDEO' and contains the following sections:

- AUDIO AND VIDEO:** A section with a warning: 'Warning: Change the aspect ratio will clear the settings of privacy mask and preset and motion detection.' It includes 'Save Settings' and 'Don't Save Settings' buttons.
- VIDEO SETTINGS:** Includes 'Aspect ratio' (16:9), 'Mode' (H.264), 'Frame size' (1280x720), 'View window area' (1280x720), 'Maximum frame rate' (30), and 'Video quality' (Excellent).
- VIDEO PROFILE 1:** Includes 'Mode' (H.264), 'Frame size' (1280x720), 'View window area' (1280x720), 'Maximum frame rate' (30), and 'Video quality' (Excellent).
- VIDEO PROFILE 2:** Includes 'Mode' (JPEG), 'Frame size' (640x360), 'View window area' (640x360), 'Maximum frame rate' (30), and 'Video quality' (Excellent).
- VIDEO PROFILE 3:** Includes 'Mode' (H.264), 'Frame size' (640x360), 'View window area' (640x360), 'Maximum frame rate' (30), and 'Video quality' (Excellent).
- AUDIO SETTINGS:** Includes 'Audio in off' (checkbox), 'Audio in gain level' (20dB), 'Audio out off' (checkbox), and 'Audio out volume level' (7).

Helpful Hints on the right side provide additional information:
 

- Higher frame size, frame rate and bit rate gives better video quality.** At the same time, it requires more network bandwidth.
- For best viewing results on a mobile phone, we suggest setting the Frame Rate to 5fps and the Bit Rate to 64 kbps.**
- Aspect Ratio:** An aspect ratio is the ratio between the width and height of an image.
- Mode:** It can be H.264, JPEG, or MPEG4. In JPEG mode, the video frames are independent; MPEG4 consumes much less network bandwidth than JPEG, and H.264 can use less bandwidth but better image quality.
- Frame Size:** 5 options exist for the sizes of the video display. It is recommended using 320x176 for mobile viewing and 1280x720 for computer viewing.
- View window area:** The viewing region of the current video stream.
- Max frame rate:** The maximum number of frames that is displayed in 1 second. 30fps is the highest video quality for this camera. In general, any frame rate above 15 fps is imperceptible to the human eye.
- Video Quality:** This limits the maximal refresh frame rate, which can be combined with the 'Fixed quality' to optimize the bandwidth utilization and video quality. If the User wants to fix the bandwidth utilization regardless of the video quality, choose 'Constant bit rate' and select the desired bandwidth.
- Audio Settings:** You can use the option to switch the external microphone on/off or adjust the volume.

**Video Quality:** This limits the maximum frame rate, which can be combined with the "Fixed quality" option to optimize the bandwidth utilization and video quality. If fixed bandwidth utilization is desired regardless of the video quality, choose "Constant bit rate" and select the desired bandwidth.

**Constant bit rate:** The bps will affect the bit rate of the video recorded by the camera. Higher bit rates result in higher video quality.

**Fixed quality:** Select the image quality level for the camera to try to maintain. High quality levels will result in increased bit rates.

**Audio in off:** Selecting this checkbox will mute incoming audio.

**Audio in gain level:** This setting controls the amount of gain applied to incoming audio to increase its volume.

**Audio out off:** Selecting this checkbox will mute outgoing audio.

**Audio out volume level:** This setting controls the amount of gain applied to outgoing audio to increase its volume.

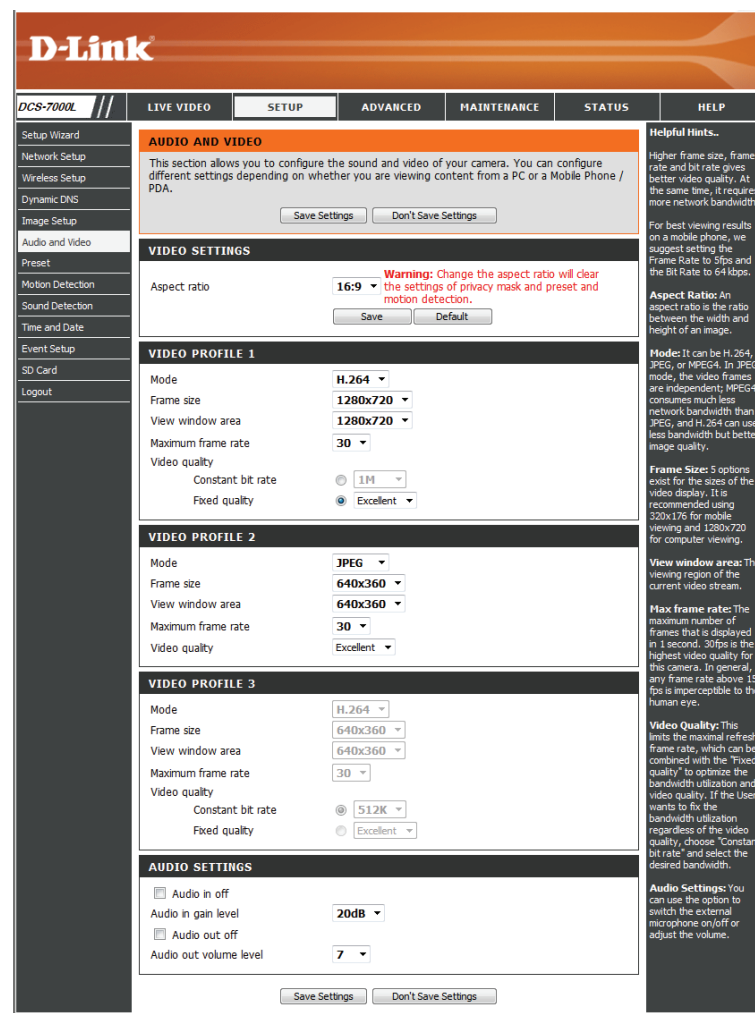



## Preset

This screen allows you to set preset points for the ePTZ function of the camera, which allows you to look around the camera's viewable area by using a zoomed view. Presets allow you to quickly go to and view a specific part of the area your camera is covering, and you can create preset sequences, which will automatically change the camera's view between the different presets according to a defined order and timing you can set.

**Note:** If your View window area is the same as your Frame size, you will not be able to use the ePTZ function.

**Video Profile:** This selects which video profile to use.

**ePTZ Speed:** You may select a value between 0 and 64. 0 is the slowest and 64 is the fastest.

**Arrow Buttons and Home Button:** Use these buttons to move to a specific part of the viewing area, which you can then set as a preset. Click the Home button to return to the center of the viewing area.

**Input Preset Name:** Enter the name of the preset you want to create, then click the **Add** button to make a new preset. If an existing preset has been selected from the Preset List, you can change its name by typing in a new name, then clicking the **Rename** button.

**Preset List:** Click this drop-down box to see a list of all the presets that have been created. You can select one, then click the **GoTo** button to change the displayed camera view to the preset. Clicking the **Remove** button will delete the currently selected preset.

**Preset Sequence:** This section allows you to create a preset sequence, which automatically moves the camera's view between a set of preset views.

The screenshot displays the D-Link web interface for the DCS-7000L camera. The top navigation bar includes tabs for LIVE VIDEO, SETUP, ADVANCED, MAINTENANCE, STATUS, and HELP. The left sidebar lists various setup options, with 'Preset' selected. The main content area is divided into two sections: 'PRESET CONTROL' and 'PRESET SEQUENCE'.

**PRESET CONTROL:** This section features a live video feed of a dog on a green sofa. To the right of the video are controls for VIDEO PROFILE (set to 1) and ePTZ Speed (set to 5). Below these are directional arrow buttons (up, down, left, right) and a Home button.

**PRESET:** This section contains an 'Input Preset Name' field with 'Add' and 'Rename' buttons. Below it is a 'Preset List' dropdown menu with a 'GoTo' button and a 'Remove' button. A note indicates that the preset name should support characters 0-9, A-Z, a-z, \*, /, and \_.

**PRESET SEQUENCE:** This section shows a 'Preset Name' field with 'Dwell time' selected, a 'Preset List' dropdown, and an 'Add' button. Below these are a 'Dwell time' field set to 10 and an 'Update' button. A note indicates that the dwell time should be between 3 and 30 seconds.

**Helpful Hints:** A sidebar on the right provides instructions on how to use the Pan, Tilt, and Zoom (PTZ) controls to move the camera view to a specific position and save it as a preset. It also explains that a preset sequence is an automated series of camera movements from one preset position to another, such as a guard tour.



**Preset List:** To add a preset to the sequence, select it from the drop-down box at the bottom of this window, set the **Dwell time** to determine how long the camera view will stay at that preset, then click the **Add** button. The preset name will appear in the list, followed by the dwell time to view that preset for.

You can rearrange your presets in the sequence by selecting a preset in the sequence, then clicking the arrow buttons to move it higher or lower in the current sequence.

Clicking the trash can button will remove the currently selected preset from the sequence.

If you want to change the dwell time for a preset, select it from the list, enter a new dwell time, then click the **Update** button.



## Motion Detection

Enabling Video Motion will allow your camera to use the motion detection feature. You may define a motion area that will be used for monitoring. After making any changes, click the **Save Settings** button to save your changes.

**Enable Video Motion:** Select this box to enable the motion detection feature of your camera.

**Sensitivity:** Specifies the measurable difference between two sequential images that would indicate motion. Please enter a value between 0 and 100.

**Percentage:** Specifies the amount of motion in the window being monitored that is required to initiate an alert. If this is set to 100%, motion is detected within the whole window will trigger a snapshot.

**Draw Motion Area:** Draw the motion detection area by dragging your mouse in the window (indicated by the red square).

**Erase Motion Area:** To erase a motion detection area, simply click on the red square that you wish to remove.

Right clicking on the camera image brings up the following menu options:

**Select All:** Draws a motion detection area over the entire screen.

**Clear All:** Clears any motion detection areas that have been drawn.

**Restore:** Restores the previously specified motion detection areas.

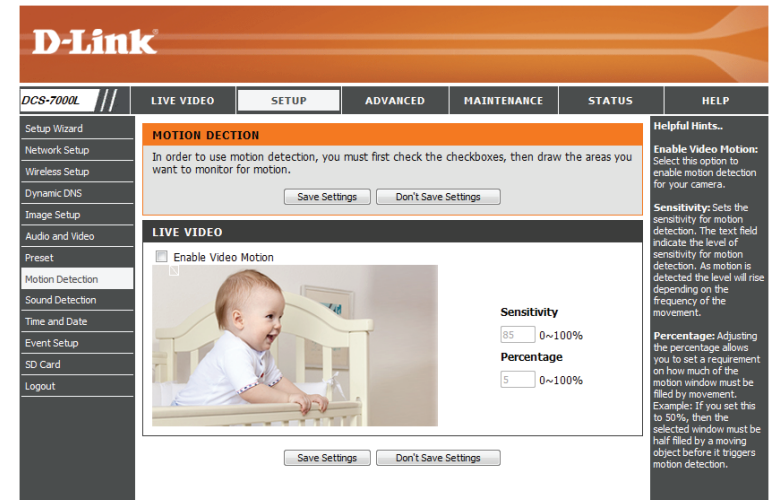

## Sound Detection

Enabling Sound Detection will allow your camera to use the built-in microphone to trigger events with audio. If this option is selected, the trigger by option under SD recording, Video Clip, or Snapshot should also be selected. After making any changes, click the **Save Settings** button to save your changes.

**Enable Sound Detection:** Check this box to enable the motion detection feature of your camera.

**Detection Level:** Specifies the measurable level that would indicate sound. Please enter a value between 50 and 90, the higher the number the more sensitive the camera will be to sound.

The screenshot displays the D-Link DCS-7000L web interface. The top navigation bar includes 'LIVE VIDEO', 'SETUP', 'ADVANCED', 'MAINTENANCE', 'STATUS', and 'HELP'. The left sidebar lists various setup options, with 'Sound Detection' selected. The main content area is titled 'SOUND DETECTION' and contains the following text: 'In order to enable your camera Sound Detection, you must select the checkbox of 'Sound Detection' and configure the Detection Level setting of your camera for your detection environment.' Below this text are two buttons: 'Save Settings' and 'Don't Save Settings'. A checkbox labeled 'Sound Detection' is currently unchecked. The 'Detection Level' is set to 60 dB, shown in a dropdown menu. A graph below the dropdown shows a horizontal red line at the 60 dB level on a scale from 40 to 100 dB. The x-axis is labeled 'Time'. At the bottom of the page, there are two more buttons: 'Save Settings' and 'Don't Save Settings'. On the right side, there is a 'Helpful Hints...' section with text explaining that sound detection uses the microphone and that a lower detection level makes small sounds easier to detect.

## Time and Date

This section allows you to automatically or manually configure, update, and maintain the internal system clock for your camera. After making any changes, click the **Save Settings** button to save your changes.

**Time Zone:** Select your time zone from the drop-down menu.

**Enable Daylight Saving:** Select this to enable Daylight Saving Time.

**Auto Daylight Saving:** Select this option to allow your camera to configure the Daylight Saving settings automatically.

**Set Date and Time Manually:** Selecting this option allows you to configure the Daylight Saving date and time manually.

**Offset:** Sets the amount of time to be added or removed when Daylight Saving is enabled.

**Synchronize with NTP Server:** Enable this feature to obtain time automatically from an NTP server.

**NTP Server:** Network Time Protocol (NTP) synchronizes the DCS-7000L with an Internet time server. Choose the one that is closest to your location.

**Set the Date and Time Manually:** This option allows you to set the time and date manually.

**Copy Your Computer's Time Settings:** This will synchronize the time information from your PC.

**D-Link**

DCS-7000L // LIVE VIDEO SETUP ADVANCED MAINTENANCE STATUS HELP

**TIME AND DATE**

You can set the current time for the IP camera.

Save Settings Don't Save Settings

**TIME CONFIGURATION**

Time Zone (UTC-08:00) Pacific Time (US & Canada)

Enable Daylight Saving

Auto Daylight Saving

Set date and time manually

Offset: +2:00

Month Week Day of week Hour Minutes

Start time: 5 1 Sunday 00 00

End time: 10 1 Sunday 00 00

**AUTOMATIC TIME CONFIGURATION**

Synchronize with NTP Server

NTP Server: ntp.dlink.com.tw << Select NTP Server

**SET DATE AND TIME MANUALLY**

Set date and time manually

Year: 2014 Month: 1 Day: 2

Hour: 4 Minute: 9 Second: 53

Copy Your Computer's Time Settings

Save Settings Don't Save Settings

**Helpful Hints...**

Good timekeeping is important for accurate logs and scheduled firmware updates.

**Time Zone:** Select your time zone from the drop-down menu.

**Enable Daylight Saving:** Select this to enable the daylight saving time.

**Auto Daylight Saving:** When you select it, the clock is automatically adjusted according to the daylight saving time of the selected time zone.

**Offset:** Select the time offset, if your location observes daylight saving time.

**Synchronize with NTP Server:** With the option selected, the camera will synchronize the time settings with the NTP server over the Internet whenever the camera starts up. If the timeserver cannot be reached, no time settings will be applied.

**NTP Server:** Network Time Protocol (NTP) synchronizes the IP camera with an Internet time server. Choose the one that is closest to your location.

**Copy Your Computer's Time Settings:** This will synchronize the time information from your PC.

## Event Setup

In a typical application, when motion is detected, the DCS-7000L sends images to a FTP server or via e-mail as notifications. As shown in the illustration below, an event can be triggered by many sources, such as motion detection or external digital input devices. When an event is triggered, a specified action will be performed. You can configure the DCS-7000L to send snapshots or videos to your e-mail address or FTP site.

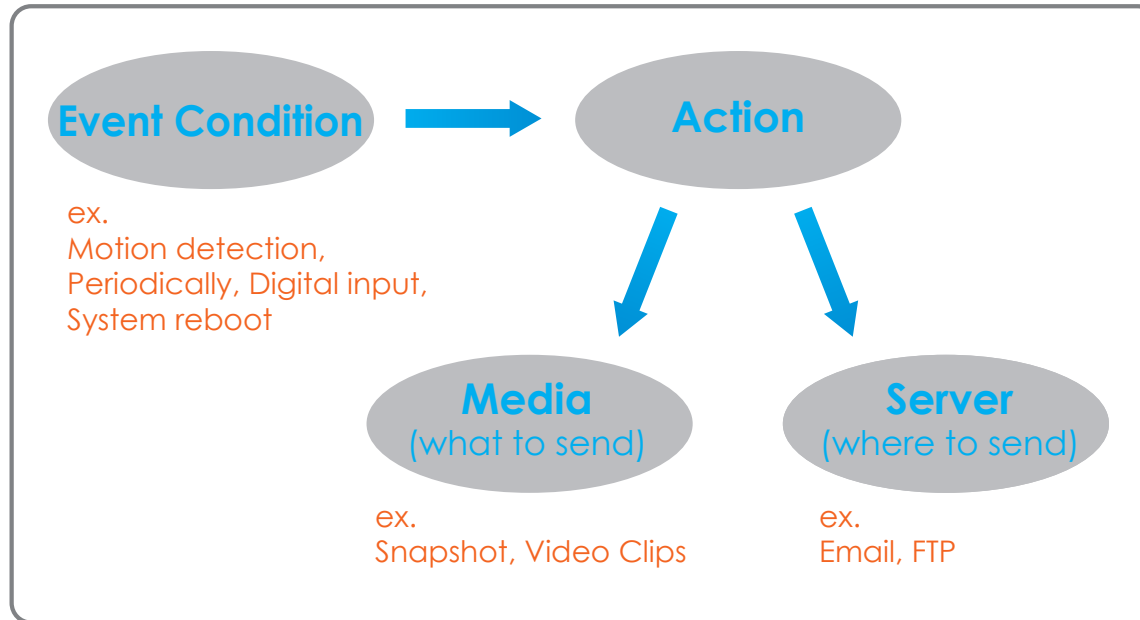

To start plotting an event, it is suggested to configure server and media columns first so that the DCS-7000L will know what action shall be performed when a trigger is activated.

## Section 4: Configuration

The Event Setup page includes 4 different sections.

- Server
- Media
- Event
- Recording

1. To add a new item - "server, media, or event," click **Add**. A screen will appear and allow you to update the fields accordingly.
2. To delete the selected item from the pull-down menu of event, server or media, click **Delete**.
3. Click on the item name to pop up a window for modifying.

**D-Link**

DCS-7000L // LIVE VIDEO SETUP ADVANCED MAINTENANCE STATUS HELP

**EVENT SETUP**

There are four sections in Event Setup page. They are event, server, media and recording. Click Add to pop a window to add a new item of event, server, media or recording. Click Delete to delete the selected item from event, server, media or recording. Click on the item name to pop a window to edit it. There can be at most 2 events and 1 recording. There can be at most 5 server and 5 media configurations.

**SERVER**

Name	Type	Address/Location
<input type="button" value="Add"/>	<input type="button" value="Delete"/>	

**MEDIA**

Name	Type	Source
<input type="button" value="Add"/>	<input type="button" value="Delete"/>	

**EVENT**

Name	Status	Sun	Mon	Tue	Wed	Thu	Fri	Sat	Time	Trigger
<input type="button" value="Add"/>	<input type="button" value="Delete"/>									

**RECORDING**

Name	Status	Sun	Mon	Tue	Wed	Thu	Fri	Sat	Time	Source	Destination
<input type="button" value="Add"/>	<input type="button" value="Delete"/>										

**Helpful Hints...**

Suggest setting server and media first before setting event. The servers and media which selected in event list are not be able to modify or delete. Please remove them first from the event if you want to delete or modify them. Recommend using different media in different event to make use all media be produced and received correctly. If using the same media in different events and the events trigger almost simultaneously, the servers in the second triggered event will not receive any media; there would be only notifications.

## Add Server

You can configure up to 5 servers to save snapshots and/or video to. After making any changes, click the **Save Settings** button to save your changes.

**Server Name:** Enter the unique name of your server.

**E-mail:** Enter the configuration for the target e-mail server account.

**FTP:** Enter the configuration for the target FTP server account.

**Network Storage:** Specify a network storage device. Only one network storage device is supported.

**SD Card:** Use the camera's onboard SD card storage.

**D-Link**

DCS-7000L // LIVE VIDEO SETUP ADVANCED MAINTENANCE STATUS HELP

**SERVER**

You can set at most 5 different servers here for different event.

Test Save Settings Don't Save Settings

**SERVER TYPE**

Server Name:

Email

Sender email address

Recipient email address

Server address

User name

Password

Port

This server requires a secure connection (StartTLS)

FTP

Server address

Port

User name

Password

Remote folder name

Passive mode

Network storage

Network storage location

(for example: \\my\_nas\disk\folder)

Workgroup

User name

Password

Primary WINS server

SD Card

Test Save Settings Don't Save Settings

**Helpful Hints...**

"Server name" The unique name for server. There are four kinds of servers supported. They are email server, FTP server, HTTP server and network storage.

**Email server:**  
 "Sender email address" The email address of the sender.  
 "Recipient email address" The email address of the recipient.

**FTP server:**  
 "Remote folder name" Granted folder on the external FTP server. The string must conform to that of the external FTP server. Some FTP servers cannot accept preceding slash symbol before the path without virtual path mapping. Refer to the instructions for the external FTP server for details. The folder privilege must be open for upload.  
 "Passive Mode" Check it to enable passive mode in transmission.

**Network storage:** Only one network storage is supported.  
 "Network storage location" The path to upload the media.  
 "Workgroup" The workgroup for network storage.

**SD card:** Use the SD card for recording media.

## Add Media

There are three types of media, **Snapshot**, **Video Clip**, and **System Log**. After making any changes, click the **Save Settings** button to save your changes.

**Media Name:** Enter a unique name for media type you want to create.

**Snapshot:** Select this option to set the media type to snapshots.

**Source:** Set the video profile to use as the media source. Refer to **Audio and Video** on "Audio and Video" on page 38 for more information on video profiles.

**Send pre-event image(s) [0~3]:** Set the number of pre-event images to take. Pre-event images are images taken before the main event snapshot is taken.

**Send post-event image(s) [0~7]:** Set the number of post-event images to take. Post-event images are images taken after the main event snapshot is taken. You can set up to 7 post-event images to be taken.

**File name prefix:** The prefix name will be added on the file name.

**Add date and time suffix to file name:** Check it to add timing information as file name suffix.

**Video clip:** Select this option to set the media type to video clips.

**Source:** Set the video profile to use as the media source. Refer to "Audio and Video" on page 51 for more information on video profiles.

**Pre-event recording:** This sets how many seconds to record before the main event video clip starts. You can record up to 3 seconds of pre-event video.

**D-Link**

DCS-7000L // LIVE VIDEO SETUP ADVANCED MAINTENANCE STATUS HELP

Setup Wizard  
Network Setup  
Wireless Setup  
Dynamic DNS  
Image Setup  
Audio and Video  
Preset  
Motion Detection  
Sound Detection  
Time and Date  
Event Setup  
SD Card  
Logout

**MEDIA**  
You can set at most 5 different media here for different event.  
Save Settings Don't Save Settings

**MEDIA TYPE**

Media name:

Snapshot  
Source: Profile1  
Send 1  pre-event image(s) [0~3]  
Send 1  post-event image(s) [0~7]  
File Name Prefix:   
 Add date and time suffix to file name

Video Clip  
Source: Profile1  
Pre-event recording:  Second(s) [0~3]  
Maximum duration:  Second(s) [1~100]  
Maximum file size:  Kbytes [100~5000]  
File Name Prefix:

System log

Save Settings Don't Save Settings

**Helpful Hints...**  
"Media name" The unique name for media. There are three kinds of media. They are snapshot, video clip and system log.  
"Source" The source of profile, profile1 or profile2.  
"Send Pre-event images" The number of pre-event images.  
"Send Post-event images" The number of post-event images.  
"File name prefix" The prefix name will be added on the file name of the snapshot images.  
"Add date and time suffix to file name" Check it to add timing information as file name suffix.  
"Video clip" The source of profile, profile1 or profile2.  
"Pre-event recording" The interval of pre-event recording in seconds. There are two limitations for video clip file.  
"Maximum duration" The maximal recording file duration in seconds.  
"Maximum file size" The maximal file size would be generated.



**Maximum duration:** Set the maximum length of video to record for your video clips.

**Maximum file size:** Set the maximum file size to record for your video clips.

**File name prefix:** This is the prefix that will be added to the filename of saved video clips.

**System log:** Select this option to set the media type to system logs. This will save the event to the camera system log, but will not record any snapshots or video.

**D-Link**

DCS-7000L // LIVE VIDEO SETUP ADVANCED MAINTENANCE STATUS HELP

**MEDIA**

You can set at most 5 different media here for different event.

Save Settings Don't Save Settings

**MEDIA TYPE**

Media name:

Snapshot

Source: Profile 1

Send 1  pre-event image(s) [0~3]

Send 1  post-event image(s) [0~7]

File Name Prefix:

Add date and time suffix to file name

Video Clip

Source: Profile 1

Pre-event recording:  Second(s) [0~3]

Maximum duration:  Second(s) [1~100]

Maximum file size:  Kbytes [100~5000]

File Name Prefix:

System log

Save Settings Don't Save Settings

**Helpful Hints..**

"Media name" The unique name for media. There are three kinds of media. They are snapshot, video clip and system log.

**Snapshot:**

"Source" The source of profile, profile1 or profile2.

"Send Pre-event images" The number of pre-event images.

"Send Post-event images" The number of post-event images.

"File name prefix" The prefix name will be added on the file name of the snapshot images.

"Add date and time suffix to file name" Check it to add timing information as file name suffix.

**Video clip:**

"Source" The source of profile, profile1 or profile2.

"Pre-event recording" The interval of pre-event recording in seconds. There are two limitations for video clip file.

"Maximum duration" The maximal recording file duration in seconds.

"Maximum file size" The maximal file size would be generated.

## Add Event

Create and schedule up to 2 events with their own settings here. After making any changes, click the **Save Settings** button to save your changes.

**Event name:** Enter a name for the event.

**Enable this event:** Select this box to activate this event.

**Priority:** Set the priority for this event. The event with higher priority will be executed first.

**Delay:** Select the delay time before checking the next event. It is being used for both events of motion detection and digital input trigger.

**Video Motion Detection:** Motion is detected during live video monitoring. Select the windows that need to be monitored.

**Periodic:** The event is triggered in specified intervals. The trigger interval unit is in minutes.

**System Boot:** Triggers an event when the system boots up.

**Network Lost:** Triggers an event when the network connection is lost.

**Sound Detection:** Triggers an event when sound is detected.

**Schedule:** This option allows you to schedule the event manually.

## Add Recording

Here you can configure and schedule the recording settings. After making any changes, click the **Save Settings** button to save your changes.

**Recording entry name:** The unique name of the entry.

**Enable this recording:** Select this to enable the recording function.

**Priority:** Set the priority for this entry. The entry with a higher priority value will be executed first.

**Source:** The source of the stream.

**Recording schedule:** Scheduling the recording entry.

**Recording settings:** Configuring the setting for the recording.

**Destination:** Select the folder where the recording file will be stored.

**Total cycling recording size:** Input a value between 200 MB and 2000000 MB (2 TB) for the space allocated to recording. New recordings will replace the oldest recording when the total recording size exceeds this value.

**Size of each file for recording:** If this is selected, files will be separated based on the file size you specify.

**Time of each file for recording:** If this is selected, files will be separated based on the maximum length you specify.

**File Name Prefix:** The prefix name will be added on the file name of the recording file(s).

**D-Link**

DCS-7000L // LIVE VIDEO SETUP ADVANCED MAINTENANCE STATUS HELP

**RECORDING**

You can setup schedule recording to network storage with your specify week day and time period.

Save Settings Don't Save Settings

**RECORDING**

Recording entry name:

Enable this recording

Priority: normal

Source: Profile 1

**RECORDING SCHEDULE**

Sun  Mon  Tue  Wed  Thu  Fri  Sat

**Time**

Always

From 00:00 To 23:59

**RECORDING SETTINGS**

Destination: None

Total cycling recording size: 1000 Mbytes [200~2000000]

Size of each file for recording: 10 Mbytes

Time of each file for recording: 10 seconds

File Name Prefix:

Save Settings Don't Save Settings

**Helpful Hints..**

**Recordings:** Enable this option if you want to upload the recording to a shared folder on the network.

**Recording schedule:** Select the day(s) according to when you want the IP camera to make a video clip.

**Always:** This enables the IP camera to make video clips continuously.

**From:** The time range specified for the video clip.

**Total cycling recording size:** Please input the network path of your network storage, it will like \\DNS\IPCamRecord\, if the network storage need authentication, please enter your user name and password here.

**Note:** Please Format SD card before use. The entire data in the SD card will be erased after formatting.

## SD Card

Here you may browse and manage the recorded files which are stored on the SD card.

**Format SD Card:** Click this icon to automatically format the SD card and create "picture" & "video" folders.

**View Recorded Picture:** If the picture files are stored on the SD card, click on the picture folder and choose the picture file you would like to view.

**Playback Recorded Video:** If video files are stored on the SD card, click on the video folder and choose the video file you would like to view.

**Refresh:** Reloads the file and folder information from the SD card.

The screenshot shows the D-Link DCS-7000L web interface. The main content area is titled "SD CARD" and contains the following information:

SD Card: / SD Status: Ready  
 Files per Page: 10 Refresh 1 of 1

Delete	File	Num of files	Size
<input type="checkbox"/>	<a href="#">Picture</a>	8	
<input type="checkbox"/>	<a href="#">Video</a>	1	

Format SD Card Total: 119247KB, Used: 31848KB, Free: 87399KB  
 OK

**Helpful Hints...**  
**Format SD Card:** Click this icon, system will automatically format SD card and create "picture" & "video" folders.  
**View recorded pictures:** If SD stored recorded picture files, enter picture link and choose which picture file you desire to view. You will view picture via image viewer SW. (ie. Windows Image Viewer)  
**Playback recorded video:** If SD stored recorded video files, enter video link and choose which video file you desire to playback. Windows will guide you to open/download video file (.AVI format) so that you can playback file via video decoder SW (ie. Windows Media Player)

# Advanced

## ICR and IR

Here you can configure the ICR and IR settings. An IR(Infrared) Cut-Removable (ICR) filter can be disengaged for increased sensitivity in low light environments.

**Automatic:** The Day/Night mode is set automatically. Generally, the camera uses Day mode and switches to Night mode when needed.

**Day Mode:** Day mode enables the IR Cut Filter.

**Night Mode:** Night mode disables the IR Cut Filter.

**Schedule Mode:** Set up the Day/Night mode using a schedule. The camera will enter Day mode at the starting time and return to Night mode at the ending time.

**IR Light Control:** The camera can enable or disable the IR (infrared) light according to your preferences. This setting provides additional controls depending on your specific application.

**Off:** The IR light will always be off.

**On:** The IR light will always be on.

**Sync:** The IR light will turn on when the ICR sensor is on.

**Schedule:** The IR light will turn on or off according to the schedule that you specify below.

The screenshot shows the D-Link DCS-7000L web interface. The top navigation bar includes 'LIVE VIDEO', 'SETUP', 'ADVANCED', 'MAINTENANCE', 'STATUS', and 'HELP'. The 'ADVANCED' tab is selected, and the 'ICR AND IR' sub-tab is active. The page is divided into three main sections: 'ICR AND IR', 'ICR', and 'IR LIGHT'.

**ICR AND IR Section:** This section provides an overview of the ICR filter and its settings. It includes a description: "An IR(Infrared) Cut-Removable(ICR) filter can be disengaged from the image path for increased sensitivity in low light environments. The ICR filter will automatically engage depending on the ambient light, allowing the camera to be effective in day/night environments." It lists two steps: "1. Select the Day/Night from the radio button. The available options are Automatic, Schedule mode, Day mode and Night mode." and "2. The default value is Automatic." Below this, there are two sub-sections: "Light Sensor Sensitivity" (with options for Low, Medium, and High) and "IR Light" (with a note that built-in illuminators will be activated automatically or manually). At the bottom of this section are "Save Settings" and "Don't Save Settings" buttons.

**ICR Section:** This section is titled "Removable IR-Cut filter trigger condition:". It features three radio button options: "Automatic" (selected), "Day mode", and "Night mode". There is also a "Schedule mode" option. Below these, there is a "Day mode(24hr)" section with "From" and "To" time pickers set to 07:00 and 18:00 respectively, and a "Refresh" button.

**IR LIGHT Section:** This section is titled "IR Light Control" and has a dropdown menu set to "Medium". It includes three radio button options: "Off", "On", and "Sync. With ICR" (selected), and a "Schedule" option. Below these, there is an "IR Light Control On(24hr)" section with "From" and "To" time pickers set to 07:00 and 18:00 respectively. At the bottom of this section are "Save Settings" and "Don't Save Settings" buttons.

**Helpful Hints... Section:** This section provides detailed explanations for the various modes and settings. It defines "Automatic" as a mode that switches between Day and Night based on ambient light. It defines "Day mode" as a mode that disables the IR Cut Filter. It defines "Night mode" as a mode that enables the IR Cut Filter. It defines "Schedule mode" as a mode that follows a user-defined schedule. It defines "IR Light Control" as a feature that opens the IR Light control in poor light conditions to take clearer pictures, with options for "Off", "Sync. with ICR", and "Schedule".

# HTTPS

This page allows you to install and activate an HTTPS certificate for secure access to your camera. After making any changes, click the **Save Settings** button to save your changes.

**Enable HTTPS Secure Connection:** Enable the HTTPS service.

**Create Certificate Method:** Choose the way the certificate should be created. Three options are available:

- Create a self-signed certificate automatically**
- Create a self-signed certificate manually**
- Create a certificate request and install**

**Status:** Displays the status of the certificate.

**Note:** The certificate cannot be removed while the HTTPS is still enabled. To remove the certificate, you must first uncheck **Enable HTTPS secure connection**.

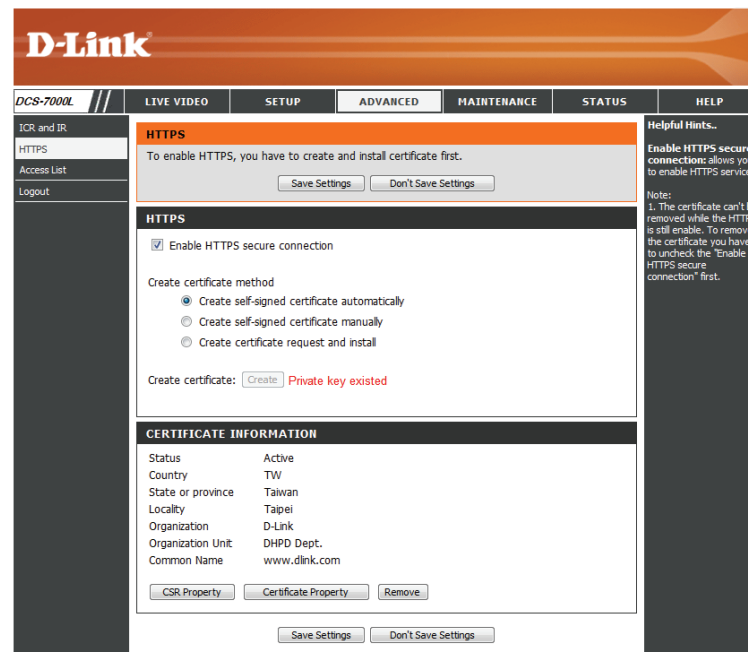

## Access List

Here you can set access permissions for users to view your DCS-7000L.

**Allow list:** The list of IP addresses that have the access right to the camera.

**Start IP address:** The starting IP Address of the devices (such as a computer) that have permission to access the video of the camera. Click **Add** to save the changes made.

**Note:** A total of seven lists can be configured for both columns.

**End IP address:** The ending IP Address of the devices (such as a computer) that have permission to access the video of the camera.

**Delete allow list:** Remove the customized setting from the Allow List.

**Deny list:** The list of IP addresses that have no access rights to the camera.

**Delete deny list:** Remove the customized setting from the Delete List.

**For example:**

When the range of the Allowed List is set from 1.1.1.0 to 192.255.255.255 and the range of the Denied List is set from 1.1.1.0 to 170.255.255.255. Only users with IPs located between 171.0.0.0 and 192.255.255.255 can access the DCS-7000L.

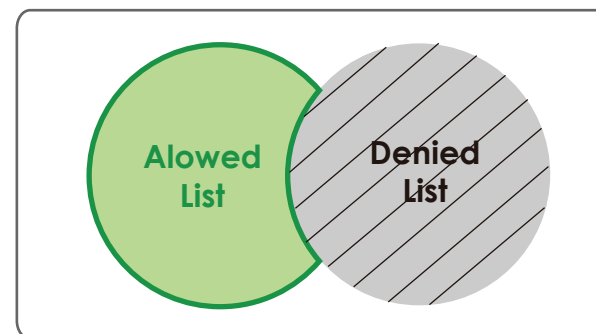
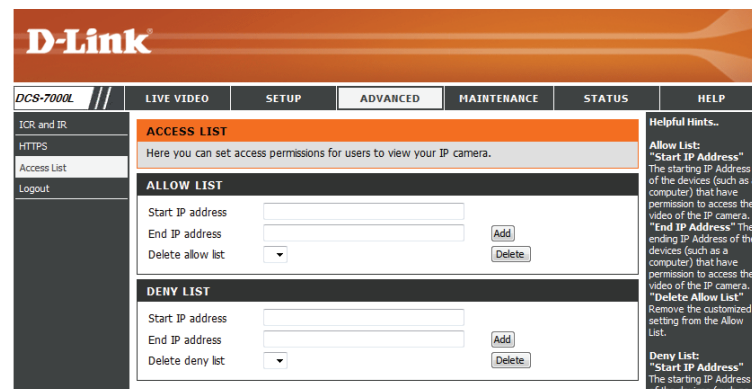

# Maintenance

## Device Management

You may modify the name and administrator's password of your camera, as well as add and manage the user accounts for accessing the camera. You may also use this section to create a unique name and configure the OSD settings for your camera.

**Admin Password Setting:** Set a new password for the administrator's account.

**Add User Account:** Add new user account.

**User Name:** The user name for the new account.

**Password:** The password for the new account.

**User List:** All the existing user accounts will be displayed here.

**Camera Name:** Create a unique name for your camera that will be added to the file name prefix when creating a snapshot or a video clip.

**Enable OSD:** Select this option to enable the On-Screen Display feature for your camera.

**Label:** Enter a label for the camera, which will be shown on the OSD when it is enabled.

**Show Time:** Select this option to enable the time-stamp display on the video screen.

**LED:** You may specify whether or not to illuminate the status LED on the camera.

The screenshot displays the D-Link web interface for the DCS-7000L camera. The top navigation bar includes 'LIVE VIDEO', 'SETUP', 'ADVANCED', 'MAINTENANCE' (selected), 'STATUS', and 'HELP'. The left sidebar shows 'Admin', 'System', 'Firmware Upgrade', and 'Logout'. The main content area is titled 'ADMIN' and contains the following sections:

- ADMIN:** A text box explaining that users can change the administrator's password, add/delete user accounts, and enable the OSD (On-Screen Display) feature.
- ADMIN PASSWORD SETTING:** Fields for 'New Password' (32 characters maximum) and 'Retype Password', with a 'Save' button.
- ADD USER ACCOUNT:** Fields for 'User Name' (20 users maximum), 'New Password' (32 characters maximum), and 'Retype Password', with an 'Add' button.
- USER LIST:** A table with 'User Name' and a 'Delete' button.
- DEVICE SETTING:** Fields for 'IP Camera Name' (63 characters maximum), 'Enable OSD' (checked), 'Label' (30 characters maximum), and 'Show Time' (checked), with a 'Save' button.
- LED:** Radio buttons for 'On' (selected) and 'Off', with a 'Save' button.

Helpful Hints on the right side provide additional information:
 

- Helpful Hints:** Enabling OSD, the IP camera name and time will be displayed on the video screen for the user.
- Security:** For security purposes, it is recommended that you change the password for your administrator account. Be sure to write down the new password to avoid having to reset the IP camera in the event that it is forgotten.
- LED:** In the rear panel of your camera there is a LED beside the network adapter. ON: The LED will flash a light to indicate if the network is working or not. OFF: No light will show, forth option is turn off.
- Privacy Control:** Allow you to configure if camera could enter Privacy mode or not.
- Privacy Off:** Camera is in a normal operating mode.
- Privacy On:** Camera is in a Privacy mode. Live Video, Video Clip, Snapshot and SD Recording will be turned off.



## System

In this section, you may backup, restore and reset the camera configuration, or reboot the camera.

**Save To Local Hard Drive:** You may save your current camera configuration as a file on your computer.

**Load From Local Hard Drive:** Locate a pre-saved configuration by clicking **Browse** and then restore the pre-defined settings to your camera by clicking **Load Configuration**.

**Restore to Factory Defaults:** You may reset your camera and restore the factory settings by clicking **Restore Factory Defaults**.

**Reboot Device:** This will restart your camera.

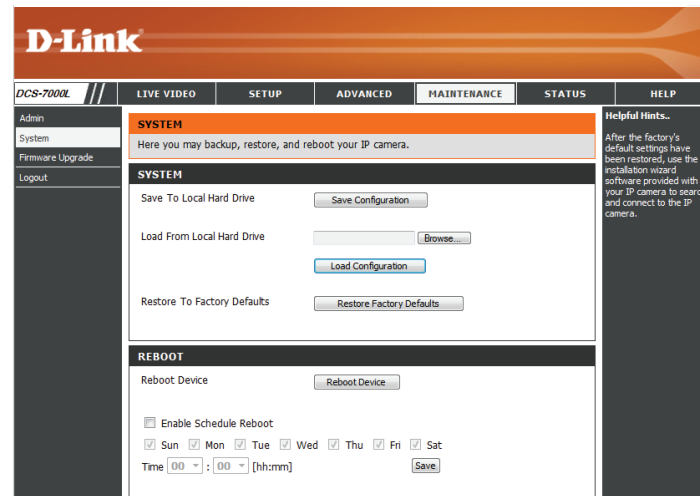

## Firmware Upgrade

The camera's current firmware version will be displayed on this screen. You may visit the D-Link Support Website to check for the latest available firmware version.

To upgrade the firmware on your DCS-7000L, please download and save the latest firmware version from the D-Link Support Page to your local hard drive. Locate the file on your local hard drive by clicking the **Browse** button. Select the file and click the **Upload** button to start upgrading the firmware.

**Current Firmware Version:** Displays the detected firmware version.

**Current Product Name:** Displays the camera model name.

**File Path:** Locate the file (upgraded firmware) on your hard drive by clicking **Browse**.

**Upload:** Uploads the new firmware to your camera.

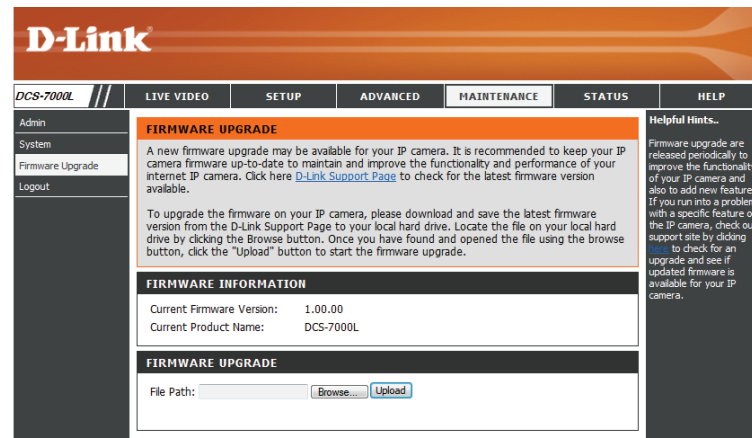

# Status Device Info

This page displays detailed information about your device and network connection.

The screenshot shows the D-Link web interface for the DCS-7000L camera. The top navigation bar includes 'LIVE VIDEO', 'SETUP', 'ADVANCED', 'MAINTENANCE', 'STATUS', and 'HELP'. The 'STATUS' tab is active, and the 'Device Info' sub-tab is selected. The main content area is titled 'DEVICE INFO' and contains the following information:

INFORMATION	
IP Camera Name	DCS-7000L
Time & Date	Thu Jan 2 04:15:02 2014
Firmware Version	1.00.00
MAC Address	CA:AC:AC:01:23:45
IP Address	192.168.0.129
IP Subnet Mask	255.255.255.0
Default Gateway	192.168.0.1
Primary DNS	192.168.0.1
Secondary DNS	0.0.0.0
PPPoE	Disable
DDNS	Disable
Agent Version	2.0.17-b53

A 'Helpful Hints...' sidebar on the right explains that this page displays all information about the IP camera and network settings.

## Logs

This page displays the log information of your camera. You may download the information by clicking **Download**. You may also click **Clear** to delete the saved log information.

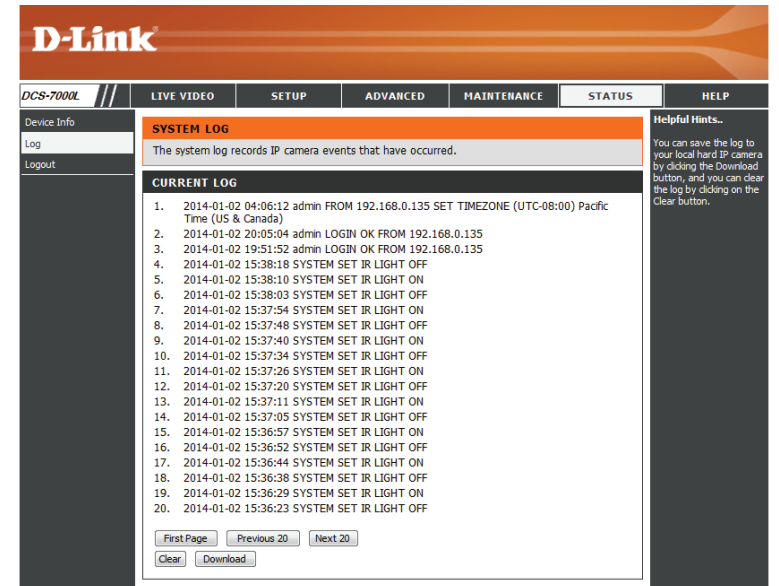

**D-Link**

DCS-7000L // LIVE VIDEO SETUP ADVANCED MAINTENANCE STATUS HELP

Device Info  
Log  
Logout

**SYSTEM LOG**  
The system log records IP camera events that have occurred.

**CURRENT LOG**

1. 2014-01-02 04:06:12 admin FROM 192.168.0.135 SET TIMEZONE (UTC-08:00) Pacific Time (US & Canada)
2. 2014-01-02 20:05:04 admin LOGIN OK FROM 192.168.0.135
3. 2014-01-02 19:51:52 admin LOGIN OK FROM 192.168.0.135
4. 2014-01-02 15:38:18 SYSTEM SET IR LIGHT OFF
5. 2014-01-02 15:38:10 SYSTEM SET IR LIGHT ON
6. 2014-01-02 15:38:03 SYSTEM SET IR LIGHT OFF
7. 2014-01-02 15:37:54 SYSTEM SET IR LIGHT ON
8. 2014-01-02 15:37:48 SYSTEM SET IR LIGHT OFF
9. 2014-01-02 15:37:40 SYSTEM SET IR LIGHT ON
10. 2014-01-02 15:37:34 SYSTEM SET IR LIGHT OFF
11. 2014-01-02 15:37:26 SYSTEM SET IR LIGHT ON
12. 2014-01-02 15:37:20 SYSTEM SET IR LIGHT OFF
13. 2014-01-02 15:37:11 SYSTEM SET IR LIGHT ON
14. 2014-01-02 15:37:05 SYSTEM SET IR LIGHT OFF
15. 2014-01-02 15:36:57 SYSTEM SET IR LIGHT ON
16. 2014-01-02 15:36:52 SYSTEM SET IR LIGHT OFF
17. 2014-01-02 15:36:44 SYSTEM SET IR LIGHT ON
18. 2014-01-02 15:36:38 SYSTEM SET IR LIGHT OFF
19. 2014-01-02 15:36:29 SYSTEM SET IR LIGHT ON
20. 2014-01-02 15:36:23 SYSTEM SET IR LIGHT OFF

First Page Previous 20 Next 20  
Clear Download

**Helpful hints...**  
You can save the log to your local hard IP camera by clicking the Download button, and you can clear the log by clicking on the Clear button.

# Help

This page provides helpful information about using and configuring your camera.

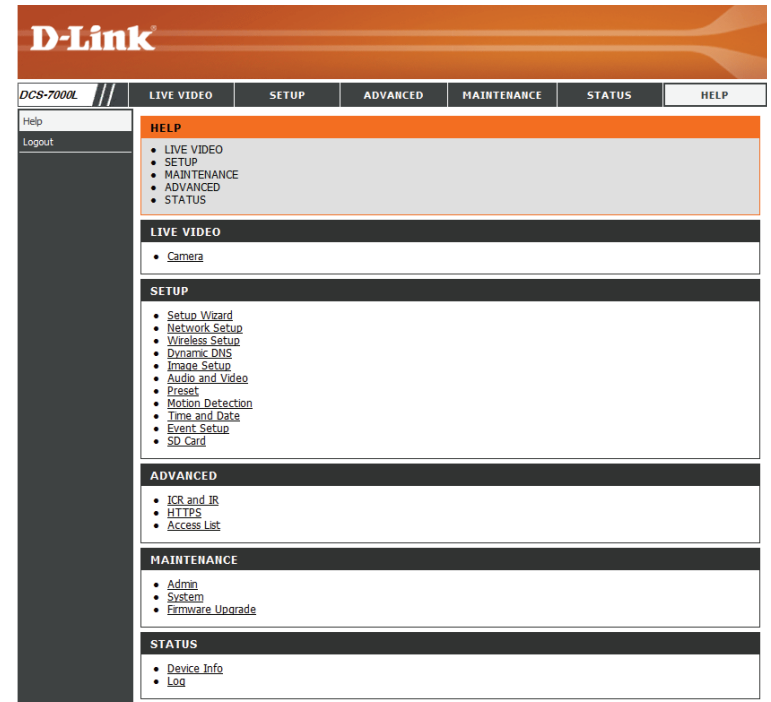

# Technical Specifications

<b>Camera</b>	Camera Hardware Profile	<ul style="list-style-type: none"> <li>▪ 1/4" Megapixel progressive CMOS sensor</li> <li>▪ 8 meter IR illumination distance</li> <li>▪ Minimum illumination 0 Lux with IR LED on</li> <li>▪ Built-in Infrared-Cut Removable (ICR) filter module</li> <li>▪ Built-in Audio in / Audio out</li> <li>▪ Minimum object distance: 200 mm</li> <li>▪ 10x digital zoom</li> </ul>	<ul style="list-style-type: none"> <li>▪ Fixed length 2.4 mm</li> <li>▪ Aperture f/2.0</li> <li>▪ Angle of view:               <ul style="list-style-type: none"> <li>▪ (H) 98°</li> <li>▪ (V) 52°</li> <li>▪ (D) 115°</li> </ul> </li> </ul>
	Image Features	<ul style="list-style-type: none"> <li>▪ Configurable image size, quality, frame rate, and bit rate</li> <li>▪ Time stamp and text overlays</li> <li>▪ Configurable motion detection windows</li> </ul>	<ul style="list-style-type: none"> <li>▪ Configurable privacy mask zones</li> <li>▪ Configurable shutter speed, brightness, saturation, contrast, sharpness</li> </ul>
	Video Compression	<ul style="list-style-type: none"> <li>▪ Simultaneous H.264 / MJPEG format compression</li> <li>▪ H.264 multicast streaming</li> </ul>	<ul style="list-style-type: none"> <li>▪ JPEG for still images</li> </ul>
	Video Resolution	<ul style="list-style-type: none"> <li>▪ 16:9 - 1280x720, 800x448, 640x360, 480x272, 320x176 up to 30 fps recording<sup>1</sup></li> </ul>	<ul style="list-style-type: none"> <li>▪ 4:3 -960x720, 800x592, 640x480, 480x352, 320x240 up to 30 fps recording<sup>1</sup></li> </ul>
	Audio Compression	<ul style="list-style-type: none"> <li>▪ G.711</li> </ul>	
	External Device Interface	<ul style="list-style-type: none"> <li>▪ 10/100 BASE-TX Fast Ethernet port</li> <li>▪ IEEE 802.11a/b/g/n/ac 2.4 GHz, 5 GHz dual-band wireless</li> </ul>	<ul style="list-style-type: none"> <li>▪ microSD card slot<sup>2</sup></li> </ul>
<b>Network</b>	Network Protocols	<ul style="list-style-type: none"> <li>▪ IPv6</li> <li>▪ IPv4</li> <li>▪ TCP/IP</li> <li>▪ UDP</li> <li>▪ ICMP</li> <li>▪ DHCP client</li> <li>▪ NTP client (D-Link)</li> <li>▪ DNS client</li> <li>▪ DDNS client (D-Link)</li> <li>▪ SMTP client</li> <li>▪ FTP client</li> <li>▪ HTTP / HTTPS</li> </ul>	<ul style="list-style-type: none"> <li>▪ Samba client</li> <li>▪ PPPoE</li> <li>▪ UPnP port forwarding</li> <li>▪ RTP / RTSP/ RTCP</li> <li>▪ IP filtering</li> <li>▪ QoS</li> <li>▪ CoS</li> <li>▪ Multicast</li> <li>▪ IGMP</li> <li>▪ SNMP (Phase II)</li> <li>▪ ONVIF compliant</li> </ul>
	Security	<ul style="list-style-type: none"> <li>▪ Administrator and user group protection</li> <li>▪ Password authentication</li> </ul>	<ul style="list-style-type: none"> <li>▪ HTTP and RTSP digest authentication</li> </ul>

## Appendix B: Technical Specifications

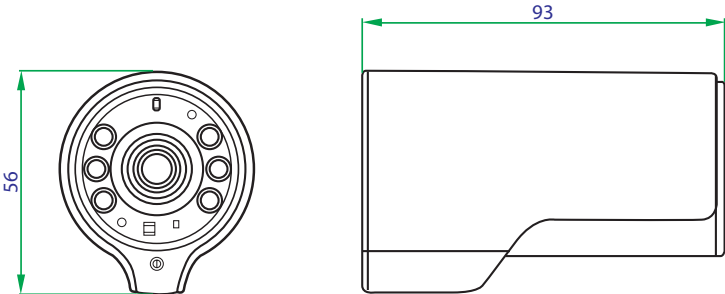
<b>System Management</b>	System Requirements for Web Interface	<ul style="list-style-type: none"> <li>Operating System: Microsoft Windows® 8/7/Vista/XP, or Mac with OS X 10.6 or higher</li> </ul>	<ul style="list-style-type: none"> <li>Browser: Internet Explorer 7, Firefox 12, Safari 6, or Chrome version 20 or higher with Java installed and enabled</li> </ul>
	Event Management	<ul style="list-style-type: none"> <li>Motion detection</li> <li>Event notification and uploading of snapshots/video clips via email or FTP</li> </ul>	<ul style="list-style-type: none"> <li>Supports multiple SMTP and FTP servers</li> <li>Multiple event notifications</li> </ul>
	Remote Management	<ul style="list-style-type: none"> <li>Take snapshots/video clips and save to local hard drive via web browser</li> </ul>	<ul style="list-style-type: none"> <li>Configuration interface accessible via web browser</li> </ul>
	Mobile Support	<ul style="list-style-type: none"> <li>mydlink Lite/mydlink+ mobile app for iPhone, iPad, and Android mobile devices</li> </ul>	
	D-ViewCam™ System Requirements	<ul style="list-style-type: none"> <li>Operating System: Microsoft Windows 8/7/Vista/XP</li> <li>Web Browser: Internet Explorer 7 or higher</li> </ul>	<ul style="list-style-type: none"> <li>Protocol: Standard TCP/IP</li> </ul>
	D-ViewCam™ Software Functions	<ul style="list-style-type: none"> <li>Remote management/control of up to 32 cameras</li> <li>Viewing of up to 32 cameras on one screen</li> </ul>	<ul style="list-style-type: none"> <li>Supports all management functions provided in web interface</li> <li>Scheduled motion triggered, or manual recording options</li> </ul>
<b>General</b>	Weight	<ul style="list-style-type: none"> <li>115 grams</li> </ul>	
	External Power Adaptor	<ul style="list-style-type: none"> <li>Input: 100 to 240 V AC, 50/60 Hz</li> </ul>	<ul style="list-style-type: none"> <li>Output: 5 V DC, 1.2 A, 50/60 Hz</li> </ul>
	Power Consumption	<ul style="list-style-type: none"> <li>3.5 watts</li> </ul>	
	Temperature	<ul style="list-style-type: none"> <li>Operating: 0 to 40 °C (32 to 104 °F)</li> </ul>	<ul style="list-style-type: none"> <li>Storage: -20 to 70 °C (-4 to 158 °F)</li> </ul>
	Humidity	<ul style="list-style-type: none"> <li>Operating: 20% to 80% non-condensing</li> </ul>	<ul style="list-style-type: none"> <li>Storage: 5% to 95% non-condensing</li> </ul>
	Certifications	<ul style="list-style-type: none"> <li>CE</li> <li>CE LVD</li> </ul>	<ul style="list-style-type: none"> <li>FCC</li> <li>C-Tick</li> </ul>
<b>Dimensions</b>			

<sup>1</sup> Frame rates when streaming video may vary depending on network conditions and method used.

<sup>2</sup> An SD / SDHC card of Class 6 or above is recommended. Supports card capacities up to 32 GB.