

Industrial grade IP KVM switch

User manual

Description

Thank you for purchasing this IP-KVM switch. The IP KVM that means a KVM switch with remote management function. A set of keyboard, mouse, and monitor control multiple computers and can remotely control multiple computer servers. IP KVM transmits each computer's signal to the IP data packet through the Internet or private network. At the remote control side, the IP signal will be compiled again into keyboard, mouse, and monitor signals. In order to ensure data security, data packets are usually encrypted. And IP KVM can provide remote management without distance restrictions.

Features

- USB2.0 port, with USB hub, support any USB2.0 devices.
- System supported: DOS, Win95/ 98/ 98SE/ 2000/ ME/ XP, WinNT, Netware, Unix, Linux.
- Plug and play, can plug in or unplug the connected computer without turning off the KVM switch and computer. Hot plugging is not recommended.
- Excellent picture quality, resolution up to 1920*1440, bandwidth 350MHz.
- No software needed: control the host computer that need operate for network control via buttons, hotkey, OSD menu.
- With buzzer.
- With LED light.
- Support auto-scanning, default 5s.

Packing contents

8 port IP KVM switch	16 port IP KVM switch
1* 8 port KVM switch 8* KVM cable 1* user manual 1* DC12V power adapter 1* CD	1* 16 port KVM switch 16* KVM cable 1* user manual 1* DC 12V power adapter 1* CD

Interface instruction

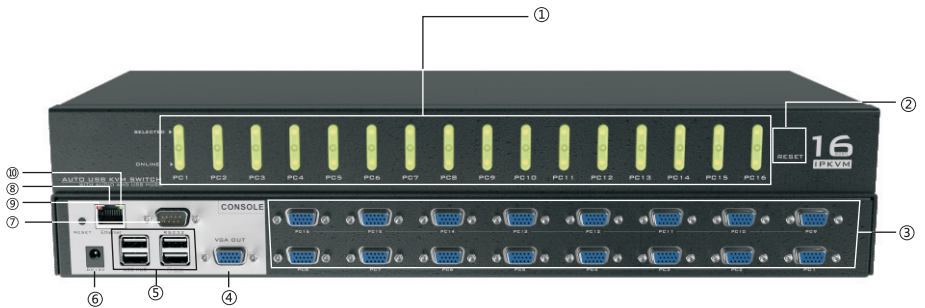
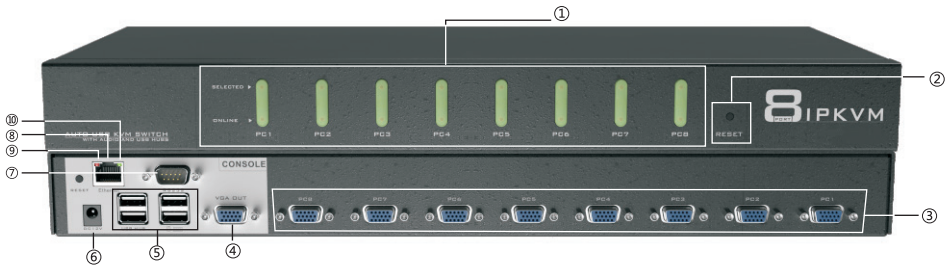



- ① 1~8/ 1~16 panel switch button
- ② reset button
- ③ input port
- ④ Output port
- ⑤ USB Hub
- LED flash fast that means data interaction
- ⑥ power port
- ⑦ serial ports are vendor-specific interfaces that users cannot use
- ⑧ LAN port: Ethernet interface
- ⑨ Red LED: 0M Ethernet connected
- ⑩ Green LED: 100M Ethernet connected

Hotkey command introduction

In addition to the front panel buttons, the KVM switch port can also be used via a simple keyboard combination. Simply press the HOME / Cap / Scroll / Num keys twice within 2s to send a command to the KVM and you will hear " Beep ". After confirm that you can use the hotkey command, this product has multiple modes to choose. HOME + HOME is the default mode, when you do not want to use this mode, you can choose another command mode. The following is the way to set different hotkey mode.

 +  default mode



 +  + Caps Enter hot-key Caps mode



 +  + Scroll enter hot-key Scroll mode

 +  +Num Enter hot-key Num mode



Default mode command

 +  + 1、2..... Switch to the corresponding port.

 +  + → or ↓ Switch to Next

 +  + ← or ↑ Switch to Pre.

 +  + B Off/ on the buzzer



 +  + S Auto-scanning, press any key to stop auto-scanning



Home+ home + Num. +enter: set the auto-scanning intervals, from 5 - 999s

If you would like to use Caps mode, please press Home+ Home+ Caps first



Caps mode Command

 +  + 1、2..... Switch to the corresponding port.

 +  + → or ↓ Switch to Next

 +  + ← or ↑ Switch to Pre.

 +  + B Off/ on the buzzer

 +  + S Auto-scanning, press any key to stop auto-scanning

Caps+ Caps+ I+ Num+ enter set the auto-scanning intervals, from 5 - 999s

OSD menu operation

Hot-key also can be achieved under OSD mode, According to the below way to choose one hot-key port from OSD menu.

Home+ Home+ Enter to active OSD menu.

Note: If you are using OSD, you can click directly when you are on the main menu.

Main menu

```
===== OSD =====
USER : ADMIN          C : 00
KVM  : 8 PORTS      VER : 0.01
! 01 - SERVER-01    T ON
 02 - SERVER-02    T
 03 - SERVER-03    T
 04 - SERVER-04
 05 - SERVER-05
 06 - SERVER-06
 07 - SERVER-07
 08 - SERVER-08
F1 - NAME   F2 - SCANTAG  F3 - SYSTEM
F4 - SCAN   F6 - ACCESS
F7 - SECUC
```

1

USER : ADMIN : According to User selected, red letter will be revised.

C : 00 : Cascade indication, 00 represents the first level, 00 represents the second level.

KVM : 8 PORTS : the digital of port: 8 shows 8 port KVM switch, 16 shows 16 port KVM switch.

! : Port selected.

T : the port auto-scanning selected.

ON : USB port is connected correctly.

Menu setting

F1: Revise port name

F2:Set the port to be scanned, used with auto-scanning mode
2 TAG (press F2 to open or close the scan, identify " T",
as shown in Figure 2 below)

F3:Set system

F4:Scan port

F6:Set the host to be assigned non-administrator users (which
hosts User 1-7 can operate)

F7:Set user login

Note: F1, F2, F3, F4, F6, F7 need to press on keyboard.

▷ F1:Modify the host name



2

Note: You can change the name of the host as you like, use the
keyboard up and down key to control, when you need to change
the host name, press the enter on keyboard can be changed

▷ F3: System setting



3

Setting method: Under the current option, press enter to enter the setting:

01: Buzzer on/ off

02: Autoscan Mode

0: All of ports

1: The option ID only scans the PC port connected to the USB

2: only scans the port that mark by "T"(as figure 3)

03: Autoscan interval, default 5s

04: After switching, the OSD shows the Banner interval

05: After switching, OSD shows banner position, after entering, press Alt+ "↑↓←→" key to adjust position

06: Plugin Jump Mode

- 0:The device will be automatically switched to the port just inserted into the USB device when all the ports are free
- 1:Plug in a USB device (When USB port has a 5V devices input), it automatically switches to the one you plugged in, giving priority.

Note: The PLUGGING JUMP MODE setting is only useful if JUMP CHECK is set to 1.

07:JUMP CHECK

- 0:NONE: Does not detect, Port switching could via panel keys or hotkey
- 1:POWER: Detects the USB is correctly plugged in and can only be switched on the port where the USB device is plugged in

Note: If set to 1, you can not switch to the port that has no USB plug, regardless of the hotkey or keypad operation

08:Check the software version information

▷ F7 : Enter the user settings



When you press F7 into the user settings, the screen shown in Figure 4, SECURITY: Y represents that need the password to enter, N on behalf of don't need the password to enter, press the "↓" into the user account, Press "enter" to into, enter the screen as Figure 5



5

F1: modify the user name (user name: ADMIN, USER1, USER2, USER behind 6 X is hidden password, you need to press F9 to view)

F9: View the current password (the figure above by F9 shows the first user's default password is 000000)

F4: Change the password

However, when set to Y, the OSD adds F5: LOGOUT options. Each time you login will be prompted, as shown in Figure 6:



6

Figure 6 USER Name: the user name above Figure 5,

Password: the password behind the user name, then you need to submit the user name and password to enter

When you want to set the administrator to enter the OSD menu operation, you need to press F5, then OSD menu will restore picture like Figure 6 .

- ▷ F6 : Set and assign the administrator user host (which hosts User 1-7 can operate)



7

When you press the "F6" into Figure 7 picture, then press F1, F2, F3, F4, F5, F6, F7, the light green in the OSD menu will appear 1, 2, 3, 4, 5, 6, 7 . These numbers represent USER1-7 users, press F12 to assign all users: DEL DELETE ALL USER'S PERMISSIONS.

For example: in Figure 7, SERVER-01 ~ SERVER-03, each of these hosts have eight users, when you enter any one user can enter to control these three hosts: At this time when you press F5 to enter the user login picture(Figure 6) write User name: USER1, password: 111111 interface as Figure 8, you can see that 1,2,3,4,5,6 computers you can operate.

```

===== OSD =====
USER:USER1          C:00
KVM :8 PORTS      VER:0-01

01 - SERVER-01      TON
02 - SERVER-02      T
03 - SERVER-03      T
05 - SERVER-05
06 - SERVER-06

F4-SCAN      F5-LOGOUT      ESC-EXIT

```

8

input the user name: user-03, password: 333333, you can see that only 1,2,3 computers can operate, and so on

```

===== OSD =====
USER:USER1          C:00
KVM :8 PORTS      VER:0-01

01 - SERVER-01      TON
02 - SERVER-02      ON
03 - SERVER-03      TON

F4-SCAN      F5-LOGOUT      ESC-EXIT

```

9

The default administrator user name: Admin, password: 000000, when you use this account, you can operate any host

Noted: When you forgot password, please set user name: Admin, password: MTVIKI.

Press the keyboard HOME + HOME + F + L + A + S + H + Enter to enter the initial settings

Cascade installation steps

Precautions before installation:

- 1.Connect output source, input source, cascade cable and keyboard, mouse.
- 2.Connect the power adapter after output source, input source, cascade cable connected to prevent the keyboard stuck phenomenon.
- 3.Please start PCs after all done.
- 4.After cascade, switch method: Panel button, OSD switching: press HOME+ HOME+ enter to activate OSD menu. You will see the picture on screen like figure 10:

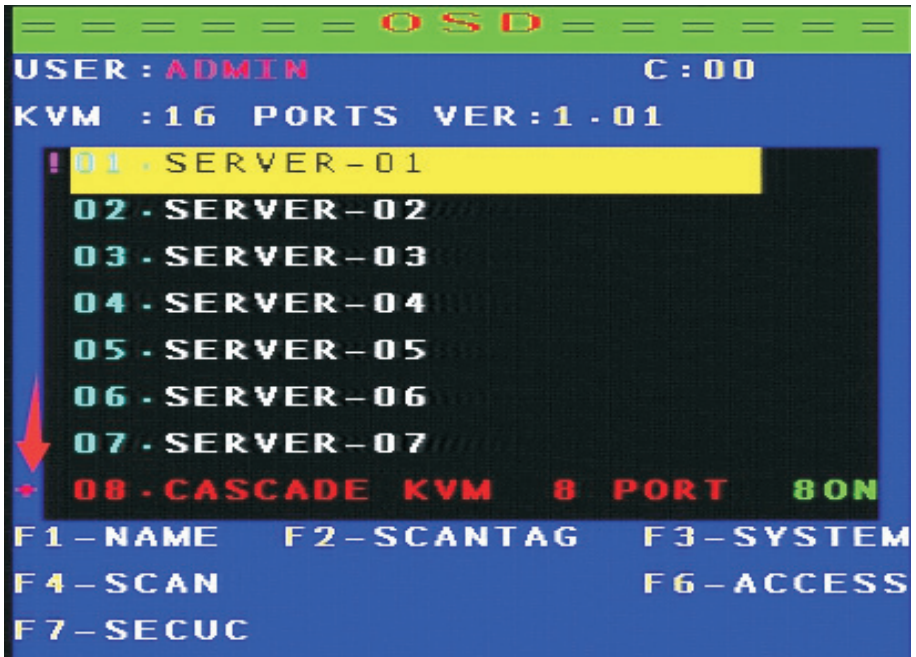

Press “↓” to control next PCs until 8th/16th port. Press “+” to control second level PCs. If you would like to back the first level PCs, please press “-” when OSD show “0.1 SERVER-01”

Note: Each products need to connect power when cascade, the product of each input port can be used as a cascade port, cascaded up to two level. (Cascade will account for an input port)

8 port cascade diagram

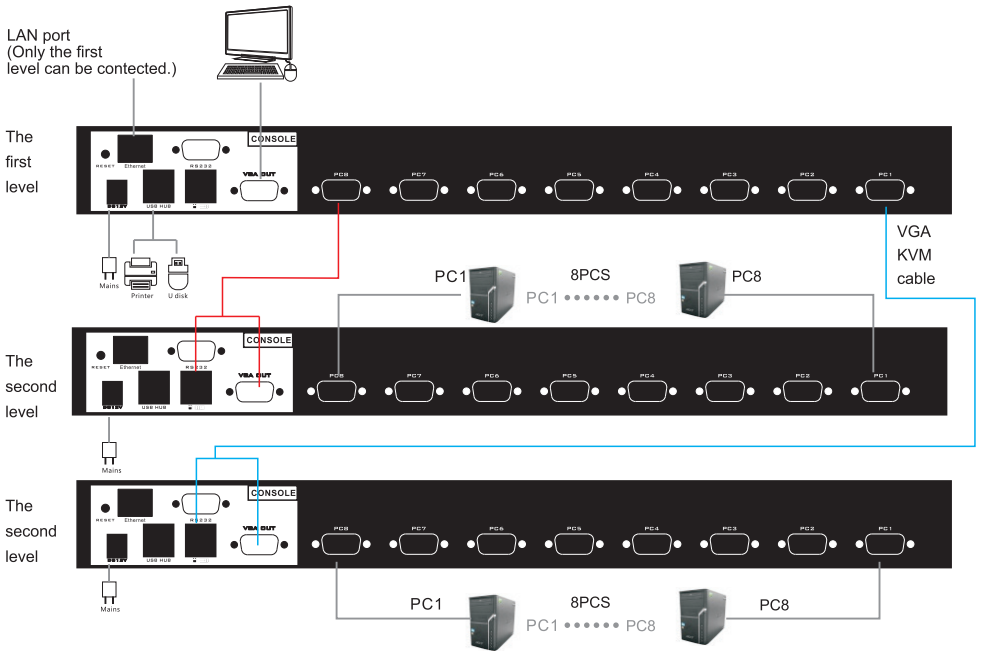

Note: 8 port KVM switch connect up to 56PCs

16 port cascade diagram

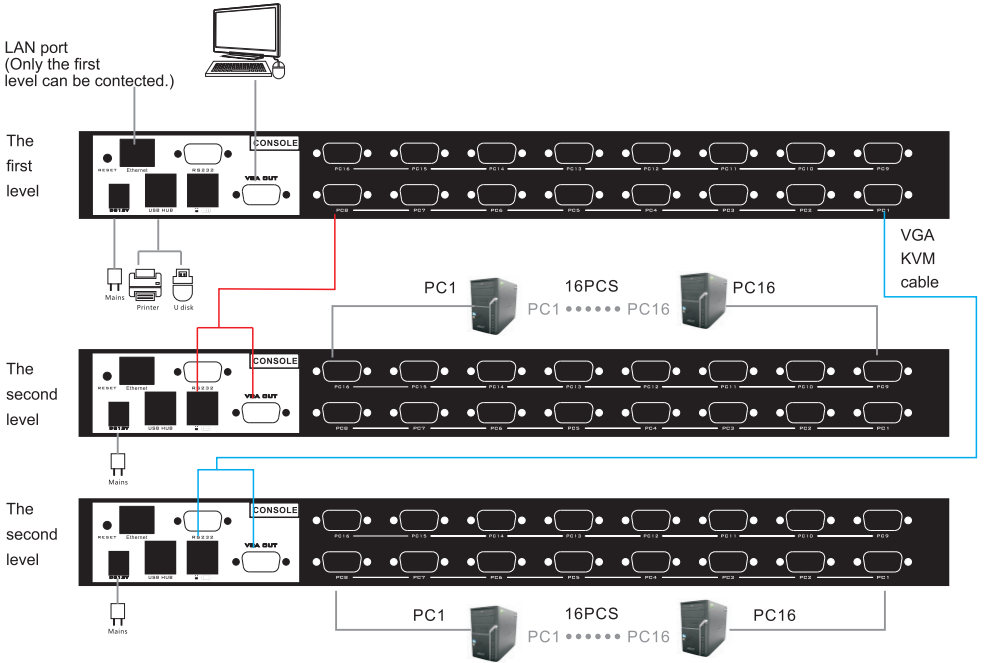

Note: 16 port KVM switch connect up to 240 Pcs.

Please note that the wiring connecting sequence, if reverse, may result in product burnout, the consequences.

IP control steps

Remote management:

Support LAN IP remote management and WAN IP remote management, Both IP (operator IP) remote management support WEB interface management.

A. Lan IP remote management:

Steps:

1. Set up and wire the IP KVM in the computer room and connect the IP KVM power adapter, and
The connection of IP KVM and the physical network.
2. Configure the remote control computer in the 192.168.1.X network segment (note: IP KVM default IP is 192.168.1.101)
3. Input <http://192.168.1.101/> in a browser on a remote management computer, You can log on to IP KVM for remote administration (the details in the following)

B. IP remote Management of WAN

Steps:

1. Set up and wire the IP KVM in the computer room and connect the IP KVM power adapter, and
The connection of IP KVM and the physical network.
2. Configure the port mapping of the root router where the remote management computer is located (Note: connects to the carrier of the root router). Port mapping method (different routers may be different, you can consult the router manufacturer how to configure.)
3. When customer in configuring port mapping, please note that our company IP KVM client port is 80, session Port is 7803.
4. Enter a mapped IP address on the remote management computer to login IP KVM goes to remote administration (the details in the following)

Login equipment

When the KVM switch starts, the local console appears the login picture. The device has a built-in administrator account, the user name is admin, initial password is 12345 . After the first successful login to the device, you can modify the password or create account.

After the device leaves the factory, the default IP address is 192.168.1.101. You can configure the network through the local console. Input the IP address in the browser. And then enter the correct user name and password, and click Login to access the device.

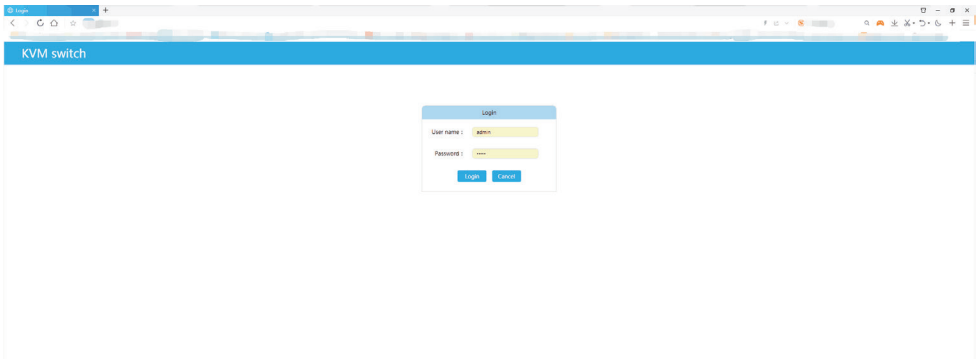

The current supported browse: IE7.0 and above version, Firefox, Opera, Maxthon, chrome, QQ browser, Safari, etc. After a successful login, the “Target device page” opens by default. It lists all the ends port information, including target machine name (CIM naming), CIM type, online State and access hyperlinks.

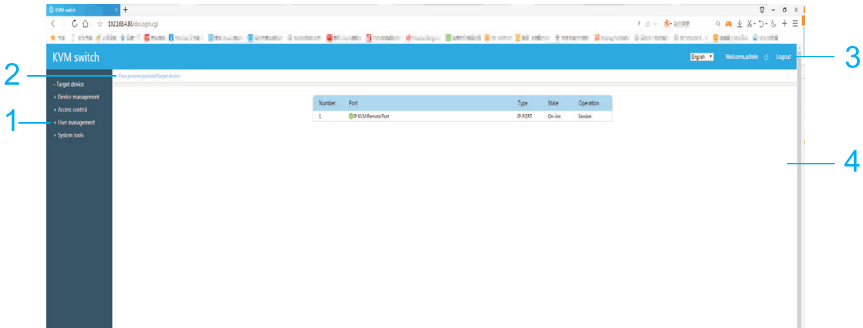

Browser interface page composition

S/N	Component	Function description
1	Menu	Contains all the operation of device and subcategories of configuration, the menu bar lists are determined by the user rights, which make sure when created user.
2	Navigation bar	Displays the path to the current page.
3	Write-off	Click this button to exit the user login.
4	Main panel	The main display area shows the menu bar options you selected.





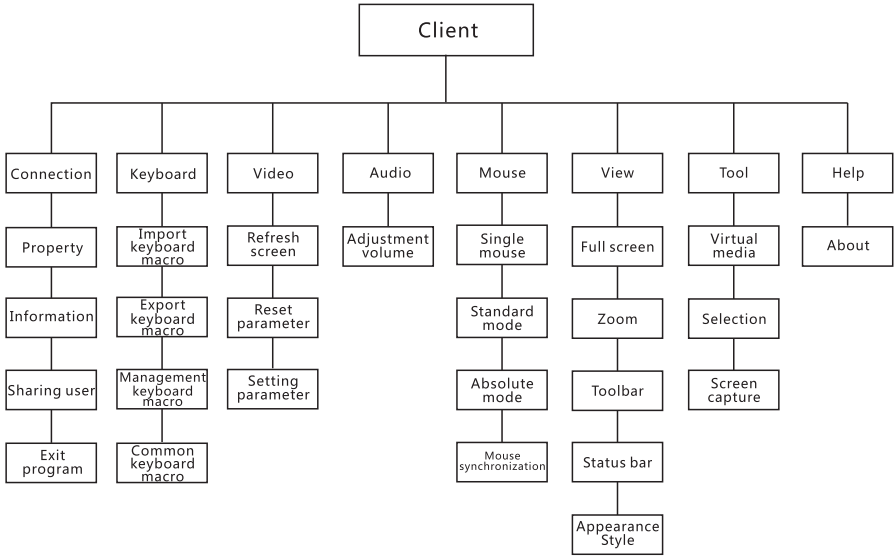

Remote session

When you successfully login to the remote console, the "Target device page" opens. This page lists all the target servers connected to the device port, their status and availability, provide access to the target server. When the CIM module of the target server is online and the physical connection is correct, click on the "session" hyperlink of this port will pop up the remote client interface of the target machine. The remote session interface and use will be described in detail in the following.

Menu tree



Toolbar shortcut icon

Icon	Function description
	Full screen
	Refresh screen
	Reset parameters: restore the screen parameters to the default values and refresh the screen
	Set video parameters
	Single mouse mode
	Mouse synchronization

2. Connection menu

Properties dialog box

Property dialog box to constrain the network bandwidth used by the KVM remote client to reach the best conversation effect. Typically, you don't have to set this, KVM built-in the compression algorithm automatically adjusts the compression parameters.

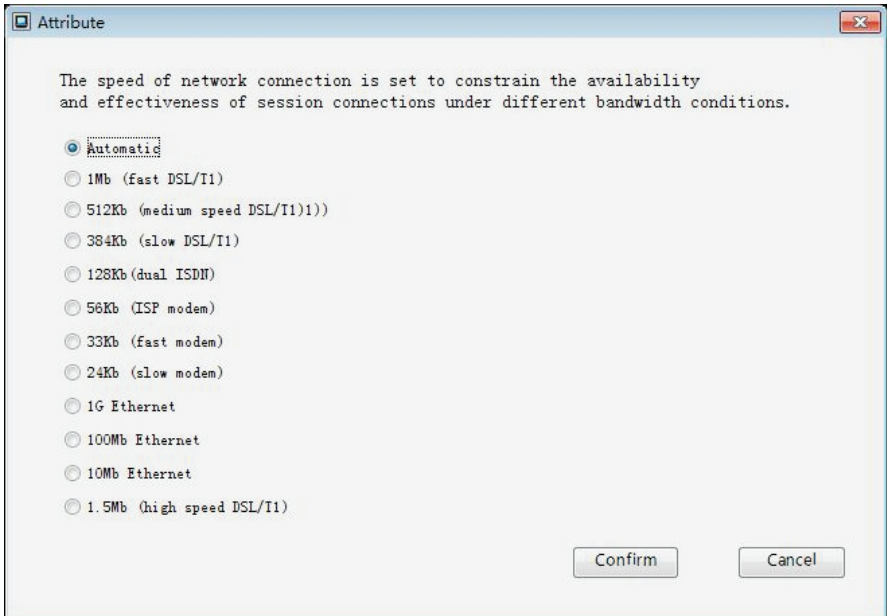

Information

Displays the following information for the current session:

- The name of the KVM device; the name of the KVM switch device which the current session connected.
- KVM device IP address: the IP address of the KVM switch of the current session connected.
- Connection time; the duration of the current session opening.
- CIM module type; CIM module model of session connection, such as USB, PS2, etc.
- Frame rate; video dynamic frame rate for the current session.

- Horizontal resolution: the pixels in the horizontal direction of the current session video.
- Vertical resolution: the pixels in the vertical direction of the current session video.
- Refresh rate: refresh rate of the target server that current session connected

Copy to system Shearing clipboard is used to copy the contents of the information dialog box to the system clipboard for other purposes.

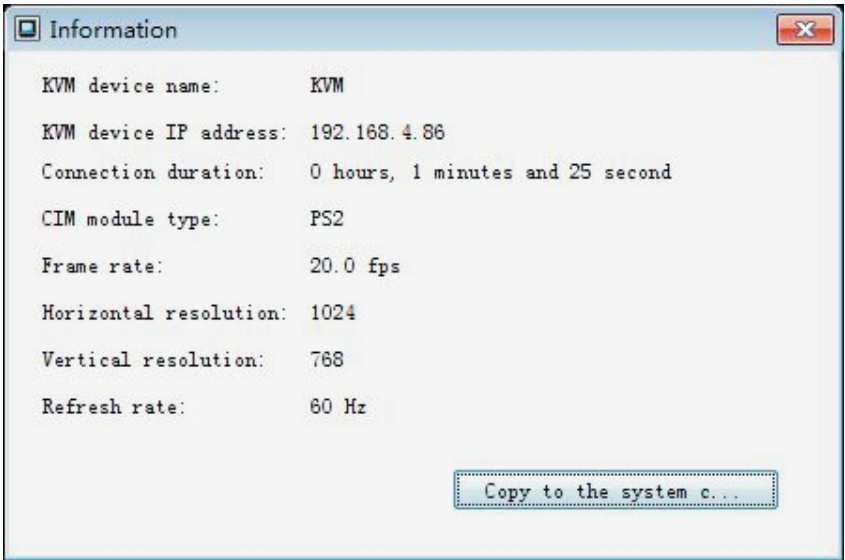

Exit program

This operation will close the current client.

3. Keyboard menu

This menu contains all the actions and commands related to the keyboard, mainly keyboard macros.

Import keyboard macros

Import the XML file that defines the keyboard macro. The client port parses the xml file into keyboard macros.

Export keyboard macros

Used to export and save the defined keyboard macro as a file.

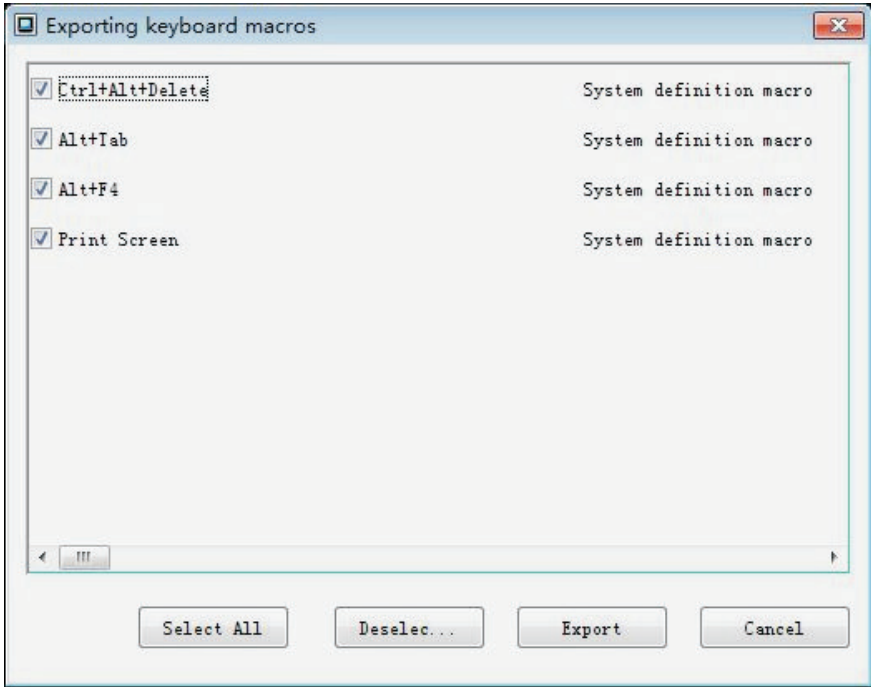

Manage keyboard macros

The main functions are to add, delete, define keyboard macros, etc.

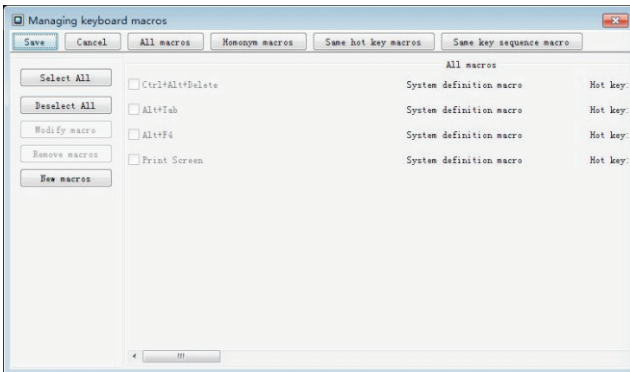

In addition, the Keyboard menu contains some commonly used keyboard macro shortcut menu. For example, "Ctrl+ Alt+ Delete", "PrintScreen", etc.

4. Video menu

The menu mainly includes refresh screen, reset parameters, and set parameters etc

Refresh screen

This command forces the video encoder to encode frames and redraw the picture to get better image effect.

Reset parameter

This command reverts the video-related parameters to the default values of the system and refreshes the screen.

Parameter setting

The video ADC and coding parameters are mainly set.

The screenshot shows a 'Video parameters' dialog box with the following sections and controls:

- Coding parameters:** Noise threshold (1, 0, slider, 7)
- Offset parameter:** Horizontal migration (131, 50, slider, 200); Vertical migration (33, 10, slider, 50)
- ADC parameters:** Sampling clock (1,344, 900, slider, 2000); Sampling accuracy (16, 0, slider, 31)
- Contrast parameter:** Contrast (red) (60, 0, slider, 100); Contrast (green) (60, 0, slider, 100); Contrast (blue) (60, 0, slider, 100)
- Luminance parameter:** Brightness (red) (70, 0, slider, 100); Brightness (green) (70, 0, slider, 100); Luminance (blue) (70, 0, slider, 100)

Buttons at the bottom: Save, Apply, Cancel

- **Noise Threshold:** The KVM switch is capable of filtering out electronic interference from the video output of the target server. This function not only optimizes image quality but also reduces bandwidth usage. If the setting is higher, different pixels are only transmitted when there is a large color difference with adjacent pixels, but the threshold sometimes causes some texture details of the image to be lost. If the setting is lower, the image is most complete, but the bandwidth usage will increase.
- **Horizontal Offset:** Controls the horizontal position that the target server displays on your display.
- **Vertical Offset:** Controls the vertical position that the target server displays on your display.
- **Sampling Clock:** Controls the display speed of video pixels on the screen. Changing the clock setting causes the video image to be stretched or shortened horizontally. In most cases users should not change the default settings..
- **Sampling accuracy:** The range is from 0 to 31. Adjusting this value will affect the sharpness of the image. When opening the target server video screen for the first time, set this value and stop at the best video image location.
- **Contrast (red):** Controls the contrast of the red signal.
- **Contrast (green):** Controls the contrast of the green signal.
- **Contrast (blue):** Controls the contrast of the blue signal.
- **Brightness (red):** Controls the brightness of the red signal.
- **Brightness (green):** Controls the brightness of the green signal.
- **Brightness (blue):** Controls the brightness of the blue signal.

Note: When the image is blurred or the focus is fault, you can adjust the phase until it is adjusted to the best effect, but usually, don't modify the pixel clock, it will cause image abnormal or no display, if necessary, modify this parameter (such as the image of the target machine is incomplete or the image display range is too large), please contact the technical of the equipment manufacturer.

5. "Mouse" menu

When controlling the target server, the client window displays two mouse cursors, one belonging to the client workstation and the other belonging to the target server. You can operate in single mouse mode or in dual mouse mode. If using dual mouse mode and the configuration is correct, then the two mouse cursors will be the same. Otherwise, you need to use mouse synchronization and set the mouse parameters of the target server.

Single mouse

This command will enter the single mouse mode, in which only the target server mouse cursor is displayed, and the local PC's mouse will not be displayed on the screen. If you want to exit single mouse mode, press the shortcut that is prompted at the top of the client, which is configurable in the options in the Tools menu.

Standard mode

This mode actually uses a standard mouse synchronization algorithm for mouse position. When using this mode, the mouse parameters of the target machine should be set correctly (refer to "Mouse Settings")

Absolute mode

In this mode, absolute coordinates are used to keep the client and target server pointers in sync. The mouse will move to the exact location on the target server.

Mouse synchronization

In dual mouse mode, this action forces the target server's mouse pointer to match the client's mouse pointer position.

6. The "view" menu

Full screen

When entering full screen mode, the display of the target server will fill the whole screen of the client and achieve the same resolution as the target. Exit this mode to use a hot-key. Hot-keys are defined in the Options dialog box under the Tools menu.

Zoom

This feature can expand or reduce the size of the target server video. Auto-Zoom automatically adjusts the size of the client's display window based on the client's screen size to view the entire screen content of the target server window and keep the aspect ratio constant.

"Full Size Zoom" shows the actual screen size of the target. When the client cannot display the entire content, you can drag the scroll bar to view it.

Toolbar

Set the display or not to display the toolbar.

Status Bar

Set the display or not to display the status bar at the bottom.

Appearance style

Set the display style of the client.

7. "Tools" menu

Virtual media

Use virtual media, user needs port access and must also set virtual media access to the port. Please refer the "Account Management". With the Virtual Media feature, you can map a local disk or ISO image to a remote target. The virtual media session open state will remain until the end of the KVM session.

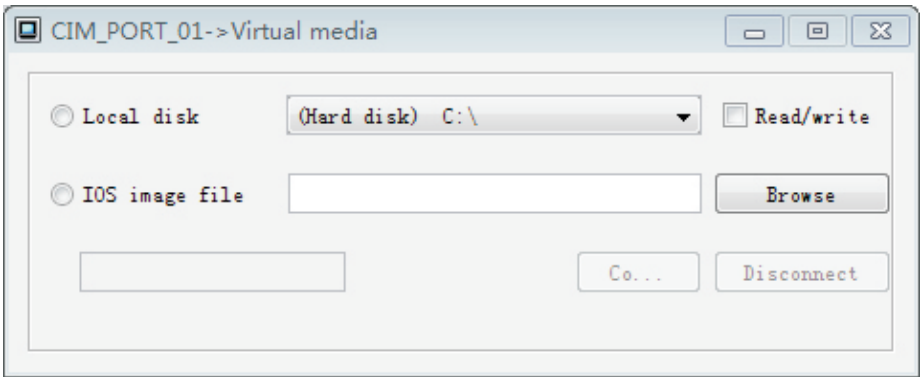

The virtual media feature supports mapping of the following media:

- (1) Local hard drive
- (2) Removable disk
- (3) CD/DVD drive
- (4) ISO image file

Option

The main configuration whether to use client logging, exit full mode, and exit the single mouse mode hot-key.

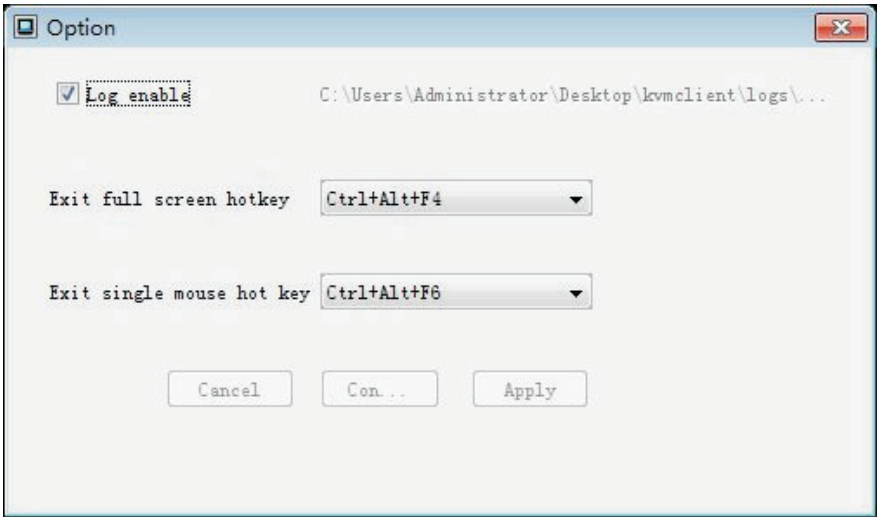

8: Help menu

It mainly displays the environment information and software version information of the client running.

