

USER MANUAL

DCS-3420

VERSION 1.0



D-Link[®]

SECURITY

Table of Contents

| | | | |
|--|----|---|----|
| Product Overview | 4 | Advanced..... | 33 |
| Package Contents..... | 4 | Network..... | 33 |
| System Requirements | 4 | Wireless | 35 |
| Introduction | 5 | Mail & FTP | 37 |
| Features..... | 6 | DDNS & UPnP | 39 |
| Hardware Overview | 7 | Video..... | 40 |
| Hardware Overview | 8 | Audio..... | 43 |
| Hardware Installation | 9 | Image Setting..... | 44 |
| Installation | 11 | Motion Detection..... | 45 |
| Wireless Installation Considerations..... | 11 | Tools | 46 |
| Software Installation | 12 | Admin..... | 46 |
| Configuration | 17 | System | 47 |
| Installation Wizard | 17 | Applications | 48 |
| Setup | 18 | Default..... | 50 |
| Network Settings..... | 19 | Status..... | 51 |
| Wireless Network Settings..... | 20 | Device Info | 51 |
| Upgrade | 22 | Log..... | 52 |
| Enabling UPnP for Windows® XP..... | 23 | Help | 53 |
| Testing the DCS-3420..... | 28 | Record Snapshots to your FTP server | 54 |
| Viewing Your DCS-3420..... | 29 | I/O Connector | 58 |
| Using the DCS-3420 with an Internet Browser..... | 30 | DI/DO Connection Diagram | 59 |
| Home | 31 | Adjusting the Camera Focus | 62 |
| Connection Type | 32 | Replacing the Lens | 63 |
| Configuration..... | 33 | Reset and Restore..... | 64 |
| | | Installing the IP Surveillance Software | 65 |
| | | Using the IP Surveillance Software | 70 |

| | |
|--|------------|
| Launcher | 70 |
| Monitor Program | 74 |
| Playback Program..... | 107 |
| Schedule Video Recording | 118 |
| Wireless Security..... | 121 |
| What is WEP?..... | 121 |
| What is WPA? | 122 |
| Setting Security | 123 |
| Using & Configuring the DCS-3420..... | 124 |
| Router Set-Up and Installation..... | 128 |
| Troubleshooting..... | 131 |
| Wireless Basics | 134 |
| Networking Basics | 139 |
| Check your IP address | 139 |
| Statically Assign an IP address | 140 |
| Technical Specifications..... | 141 |
| Contacting Technical Support..... | 143 |
| Warranty | 144 |
| Registration..... | 149 |

Package Contents

- D-Link DCS-3420 Wireless Day & Night Internet Camera
- CAT5 Ethernet Cable
- Power Adapter
- Antenna
- Manual and Software on CD
- Quick Install Guide
- Camera Stand

Note: Using a power supply with a different voltage than the one included with your product will cause damage and void the warranty for this product.

If any of the above items are missing, please contact your reseller.



System Requirements

- Windows® 2000 or XP
- At least 256MB of memory (512MB recommended)
- An available Ethernet connection
- Internet Explorer 6.x or higher Internet Web Browser
- VGA card resolution: 800x600 or above
- CPU: 1.7GHz or above processor (2.8GHz plus processor with 512MB memory and a 32MB video card is required for multiple camera viewing and recording in IP surveillance program)

Introduction

The D-Link SECURICAM Network DCS-3420 Wireless Day & Night Internet Camera is a powerful surveillance system that connects wirelessly to your 802.11b/g* network. The DCS-3420 differs from a conventional PC Camera because it is a standalone system with a built-in CPU and Web server, providing a low-cost solution capable of solving demanding security and home/office monitoring needs. It is designed with aluminum casing for maximum heat dissipation and better protection. Snapshot enables you to save a snapshot image directly from a Web browser to a local hard drive without installing any software. With 0.5 lux light sensitivity, the DCS-3420 is capable of capturing video in rooms with minimal lighting. With optional Day & Night Auto iris lens, IR LED Lens or night vision illuminator¹, you can customize your surveillance application to enable low light or night vision video streaming. You can also zoom in on all the action with the DCS-3420's 4x digital zoom² feature. The DCS-3420 gives you the ability to monitor video and audio in your home/office using an Internet browser from any where in the world! Simple installation procedures, along with the built-in Web-based interface offers easy integration to your network environments.

Note: *Use of audio or video equipment for recording the image or voice of a person without their knowledge and consent is prohibited in certain states or jurisdictions. Nothing herein represents a warranty or representation that the D-Link product provided herein is suitable for the end-user's intended use under the applicable laws of his or her state. D-Link disclaims any liability whatsoever for any end-user use of the D-Link product, which fails to comply with applicable state, local, or federal laws.*

*Maximum wireless signal rate derived from IEEE Standard 802.11g specifications. Actual data throughput will vary. Network conditions and environmental factors lower actual data throughput rate.

¹Optional accessories for Day & Night Morning and night version surveillance are available.

²4x digital zoom enlarges an image by magnifying the pixels in a selected portion of the image by 4 times.

Features

- **Supports a Variety of Protocols:** Supporting TCP/IP networking, SMTP e-mail, HTTP and other Internet related protocols, the DCS-3420 Internet Camera can be integrated easily into other Internet/Intranet applications because of its standards-based features.
- **Remote Snapshot Images:** Using the Snapshot feature, you save snapshots directly from the Web browser to a local hard drive without installing any software, making it convenient to instantly capture any moment from a remote location.
- **Low Light Recording and 4x Digital Zoom:** The DCS-3420's 0.5 lux light sensitivity allows you to capture video in rooms with minimal lighting, making it ideal for use at night time. The camera also features 4x digital zoom for closer viewing.
- **Optional Day & Night Auto iris lens, IR LED Lens or night vision illuminator²,** you can customize your surveillance application to enable low light or night vision video streaming.
- **Web Configuration:** Using the Internet Explorer Web browser, administrators can configure and manage the Internet Camera directly from its own Web page via the Intranet or the Internet. Up to 20 user names and passwords are permitted, with privilege settings controlled by the administrator.
- **Built-in BNC (Bayonet Neil-Concelman) connector** is used for professional video connections. It benefits users who integrate digital IP camera into traditional system (CCTV) for both analog and digital video streaming purpose.
- **Powerful Surveillance and Remote Monitoring Utility:** The powerful IP surveillance software assigns an administrator with a pre-defined user ID and password who can modify the Internet Camera settings from a remote site via an Intranet or the Internet. Administrators are allowed to monitor the video image, record the video image to a hard drive, and take snapshots.
- **Broad Range of Applications:** With today's high-speed Internet, the Internet Camera provides the ideal solution for live video images over the Intranet and Internet for remote monitoring. The DCS-3420 allows remote access from an Internet Explorer Web browser for live image viewing with audio and allows the administrator to manage and control the Internet Camera anywhere and any time. Apply the Internet Camera to monitor various objects and places such as homes, offices, banks, hospitals, child-care centers, amusement parks and other varieties of industrial and public monitoring. The Internet Camera can also be used for intruder detection with its motion-detection mode, capture still images and video images for archiving and many more applications. The wireless capability means you can place the camera where it is inconvenient to install network cables.

Hardware Overview

Microphone Connector

The DCS-3420 Wireless Day & Night Internet Camera has an internal microphone built-in. However, you have the option of using an external microphone by plugging it into the microphone connector.

Antenna Connector

The antenna is included with the DCS-3420. It fastens onto the antenna connector on the back panel to provide a connection with a wireless network.



Audio Out Connector

The DCS-3420 provides an Audio Out connector to be used for 2-way audio. Speakers (not included) may be connected to the camera to provide audio for 2-way communication.

Ethernet Cable Connector

The Internet Camera's back panel features an RJ-45 connector for connections to 10Base-T Ethernet cabling or 100Base-TX Fast Ethernet cabling. This network port supports the NWay protocol, allowing the Internet Camera to automatically detect or negotiate the transmission speed of the network.

Hardware Overview

BNC

The BNC connector is used for professional video connections. It benefits users who integrate digital IP camera into traditional system (CCTV) for both analog and digital video streaming purpose.

Power LED

The power LED is positioned on the back of the camera lens next to the antenna connector. As soon as the power adapter is connected to the camera, the power LED will flash red and green several times, indicating that the DCS-3420 is conducting a self-test. Upon passing the self-test, the LED will turn green, indicating a good connection to an Ethernet port. A red LED indicates that no connection has been made.

DC Power Connector

The DC power input connector is located on the DCS-3420 Internet Camera's back panel and is labeled 12V DC with a single socket to supply power to the Internet Camera.

Reset Button

Reset will be initiated when the reset button is pressed once and held until the Power LED flashes through its cycle twice.

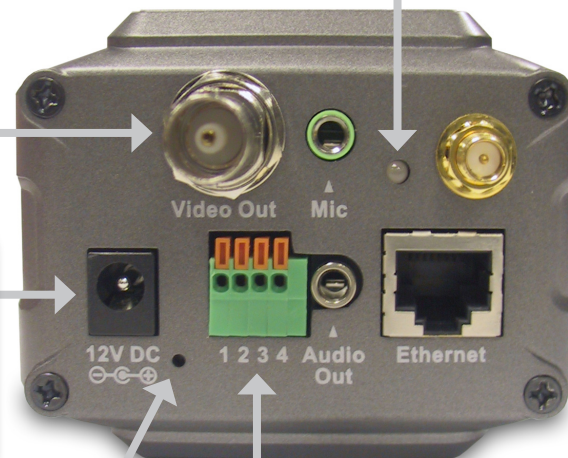

I/O Connector

The DCS-3420 provides a terminal block with two pairs of connectors situated on the back panel. One pair is for input and the other is for output. The I/O connectors provide the physical interface to send and receive digital signals to and from a variety of external devices.

Hardware Installation

If you are connecting the DCS-3420 to a wired Ethernet network, connect an Ethernet cable to the network cable connector located on the camera's back panel and attach it to the network.

Note: It is required that an Ethernet cable is used during initial setup. Once your wireless configuration is set, you may disconnect the Ethernet cable and begin communicating wirelessly with your DCS-3420.



Locate the antennas included with your DCS-3420 and attach them to the antenna connectors located on the back of the DCS-3420.



Attach the external power supply to the DC power input connector located on the Internet Camera's back panel (labeled 12VDC) and connect it to your wall outlet.

Note: When you have a proper connection, the LED will turn from red to green. The light may cycle on and off and your computer may show an intermittent loss of connectivity, this is normal until you have configured your Internet Camera.



The Internet Camera comes with a camera stand with a swivel ball screw head that can be attached to the Internet Camera bottom socket cavity. Attach the camera stand to the Internet Camera and station it for your application. There are holes located in the base of the camera stand allowing the Internet Camera to be mounted to the ceiling, or any wall securely.

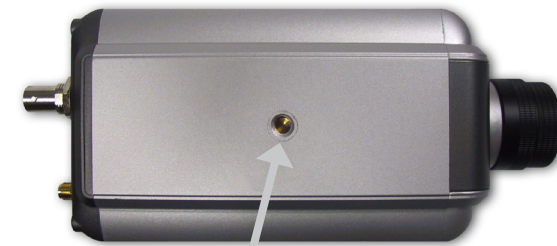

Socket for camera stand

Installation

Wireless Installation Considerations

The D-Link wireless internet camera lets you access your network using a wireless connection from virtually anywhere within the operating range of your wireless network. Keep in mind, however, that the number, thickness and location of walls, ceilings, or other objects that the wireless signals must pass through, may limit the range. Typical ranges vary depending on the types of materials and background RF (radio frequency) noise in your home or business. The key to maximizing wireless range is to follow these basic guidelines:

1. Keep the number of walls and ceilings between the D-Link adapter and other network devices to a minimum - each wall or ceiling can reduce your adapter's range from 3-90 feet (1-30 meters.) Position your devices so that the number of walls or ceilings is minimized.
2. Be aware of the direct line between network devices. A wall that is 1.5 feet thick (.5 meters), at a 45-degree angle appears to be almost 3 feet (1 meter) thick. At a 2-degree angle it looks over 42 feet (14 meters) thick! Position devices so that the signal will travel straight through a wall or ceiling (instead of at an angle) for better reception.
3. Building Materials make a difference. A solid metal door or aluminum studs may have a negative effect on range. Try to position access points, wireless routers, and computers so that the signal passes through drywall or open doorways. Materials and objects such as glass, steel, metal, walls with insulation, water (fish tanks), mirrors, file cabinets, brick, and concrete will degrade your wireless signal.
4. Keep your product away (at least 3-6 feet or 1-2 meters) from electrical devices or appliances that generate RF noise.
5. If you are using 2.4GHz cordless phones or X-10 (wireless products such as ceiling fans, lights, and home security systems), your wireless connection may degrade dramatically or drop completely. Make sure your 2.4GHz phone base is as far away from your wireless devices as possible. The base transmits a signal even if the phone is not in use.

Software Installation

Turn on the computer and Insert the D-Link DCS-3420 Driver CD in the CD-ROM drive. The step-by-step instructions that follow are shown in Windows® XP. The steps and screens are similar for the other Windows® operating systems.

Click **Installation Wizard**



If the CD Autorun function does not automatically start on your computer, click Windows® Start > Run. In the Run command box type "**D:\DCS3420.exe**", where D: represents the drive letter of your CD-ROM. If it does start, proceed to the next screen.

Please wait while the InstallShield Wizard prepares to install.

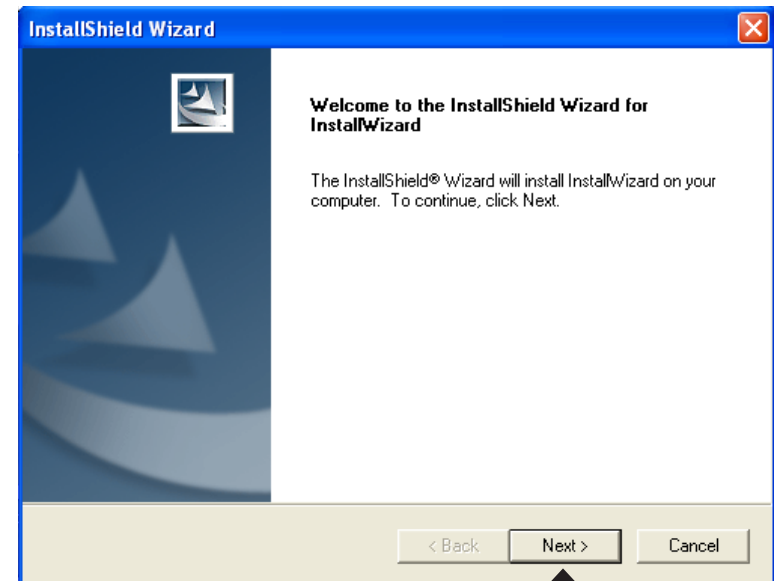
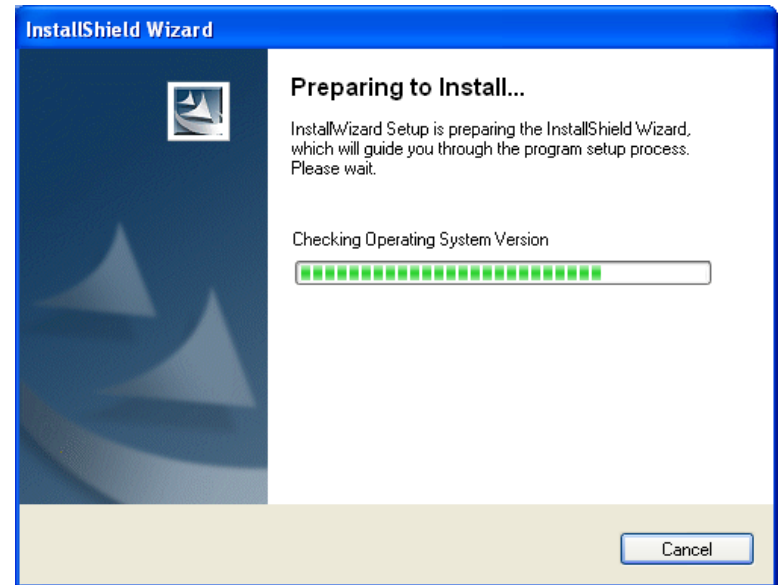

Click **Next**

The InstallShield will install the driver in the following folder. To install the driver into a different folder, click Browse and select another folder.

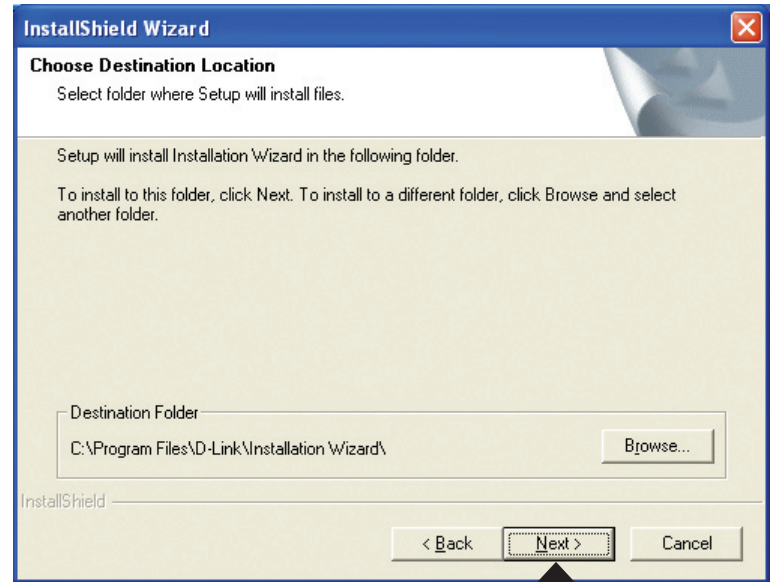

Click **Next**

Select the Program folder that Setup will add program icons to. You may type a new folder name, or select one from the existing folders list.

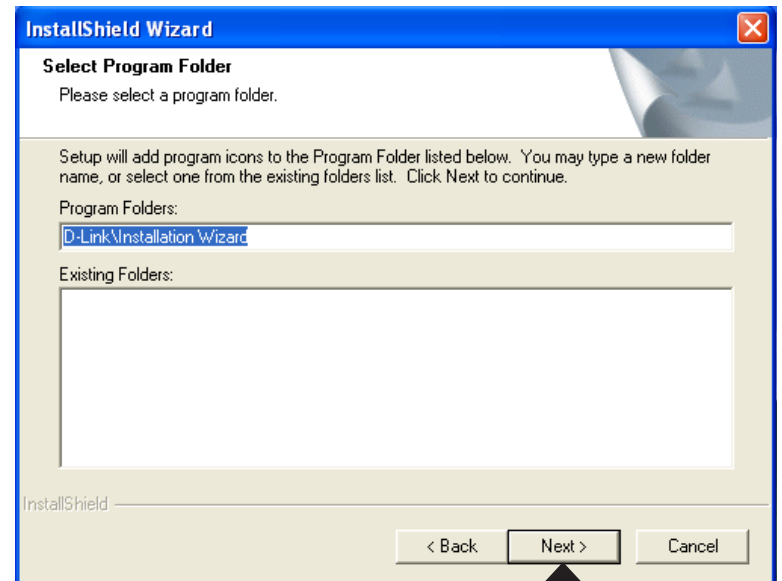

Click **Next**

Please wait while the Installation Wizard is installed.

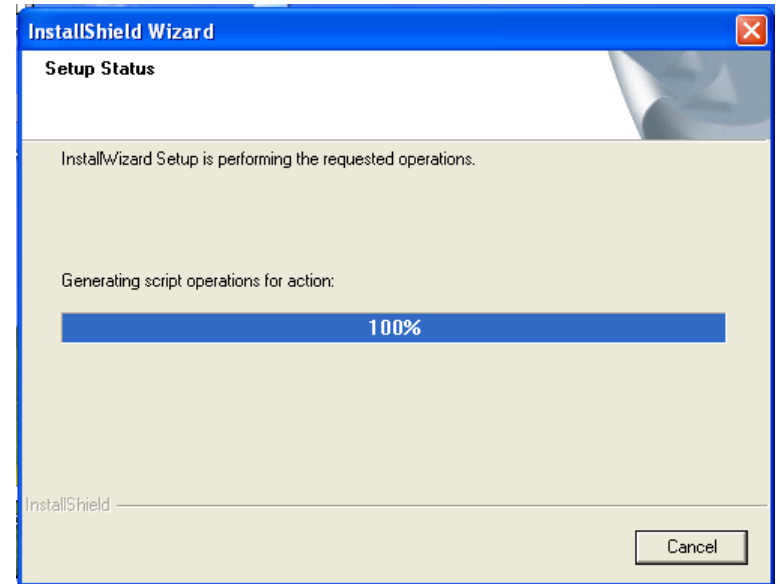

Installation is now complete.

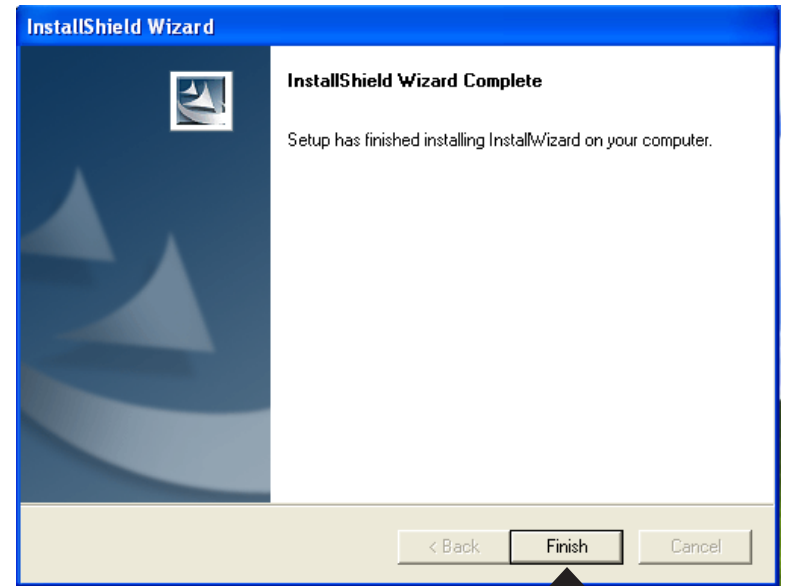

Click **Finish**

To access the Installation Wizard screen, click on the Installation Wizard Icon on your desktop.

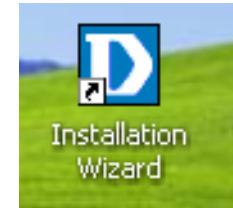

The opening Installation Wizard screen will appear and show a MAC address of the DCS-3420 and an IP Address. If you have a DHCP* server on your network, there will be a valid IP Address displayed here, indicated by a “Yes” under the assigned column.

*A DHCP server is a device that supplies IP Addresses to its clients that are on the same network.

Configuration

This section will show you how to configure your new D-Link wireless internet camera using the D-Link Installation Wizard.

Installation Wizard

The following options are available on the Installation Wizard screen by clicking on the corresponding tab:

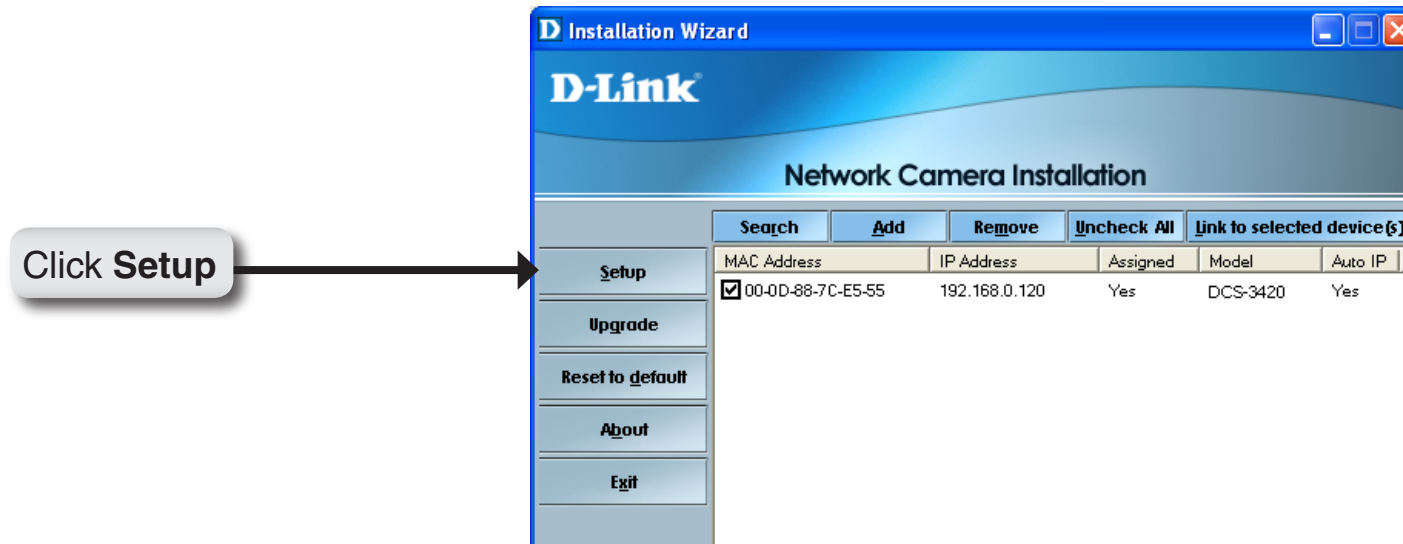

Setup

On the initial Setup Screen you can configure System and Date/Time settings for each camera. Click **Next** to configure Network settings for the camera.

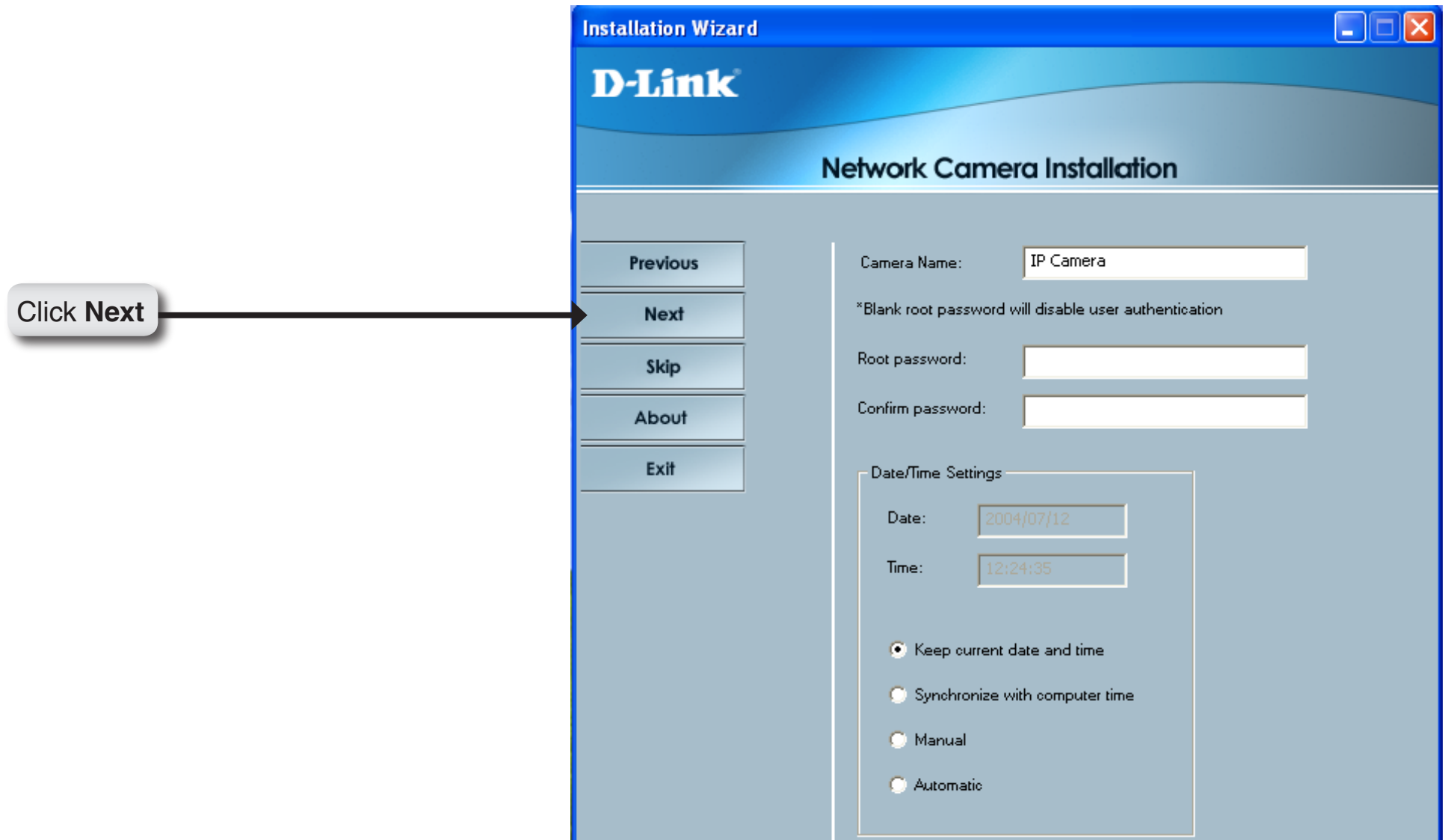

Network Settings

Users can configure the Network Settings for the camera by entering the IP address, Subnet mask, Default router IP, Primary DNS, and Secondary DNS. The option to **reset IP address at next boot** is automatically selected. If you would like to keep your IP address settings, make sure to uncheck this box.

Click **Next**

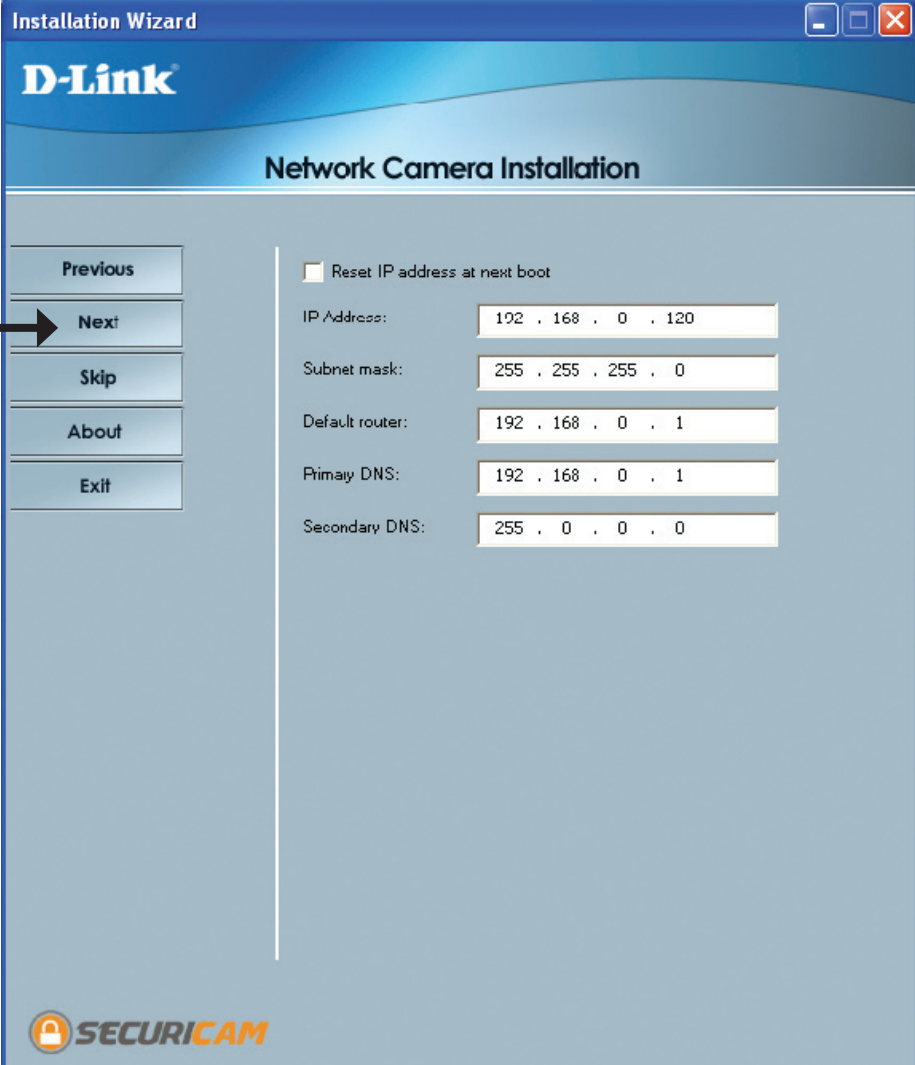

The screenshot shows the 'Installation Wizard' window for a D-Link Network Camera. The title bar reads 'Installation Wizard' and the window features the D-Link logo. The main heading is 'Network Camera Installation'. On the left side, there is a vertical navigation pane with buttons for 'Previous', 'Next', 'Skip', 'About', and 'Exit'. The 'Next' button is highlighted with a black arrow pointing to it from a 'Click Next' callout box. The main area contains a checkbox labeled 'Reset IP address at next boot' which is checked. Below this are five input fields for network configuration: IP Address (192 . 168 . 0 . 120), Subnet mask (255 . 255 . 255 . 0), Default router (192 . 168 . 0 . 1), Primary DNS (192 . 168 . 0 . 1), and Secondary DNS (255 . 0 . 0 . 0). At the bottom left, there is a 'SECURICAM' logo with a padlock icon.

Wireless Network Settings

Users can configure the Wireless Network Settings for the camera, by entering the SSID and selecting the Wireless Mode, Channel, TX Rate, and Preamble.

Click Next

Note: Check the Data Encryption box to enable data encryption and configure the settings. *These settings are explained and can also be configured on the **Advanced > Network** screen (page 33) when configuring the camera via a Web Browser.*

The screenshot shows the 'Installation Wizard' window for a D-Link Network Camera. The title bar includes the D-Link logo and window control buttons. The main heading is 'Network Camera Installation'. On the left, there are five buttons: 'Previous', 'Next', 'Skip', 'About', and 'Exit'. An arrow points from the 'Click Next' text to the 'Next' button. The main configuration area on the right contains the following settings:

- SSID: dlink
- Wireless mode: Infrastructure
- Channel: 6
- TX rate: Auto
- Preamble: Short preamble
- Data encryption
- Change Encryption Key section:
 - Auth mode: Open
 - Key length: 64 bits
 - Key format: HEX
 - Four key slots, each with a radio button and a text field containing '0000000000'.

The 'SECURICAM' logo is visible at the bottom left of the window.

Click **Apply** to save the configured settings. Users can click Previous to modify changes.

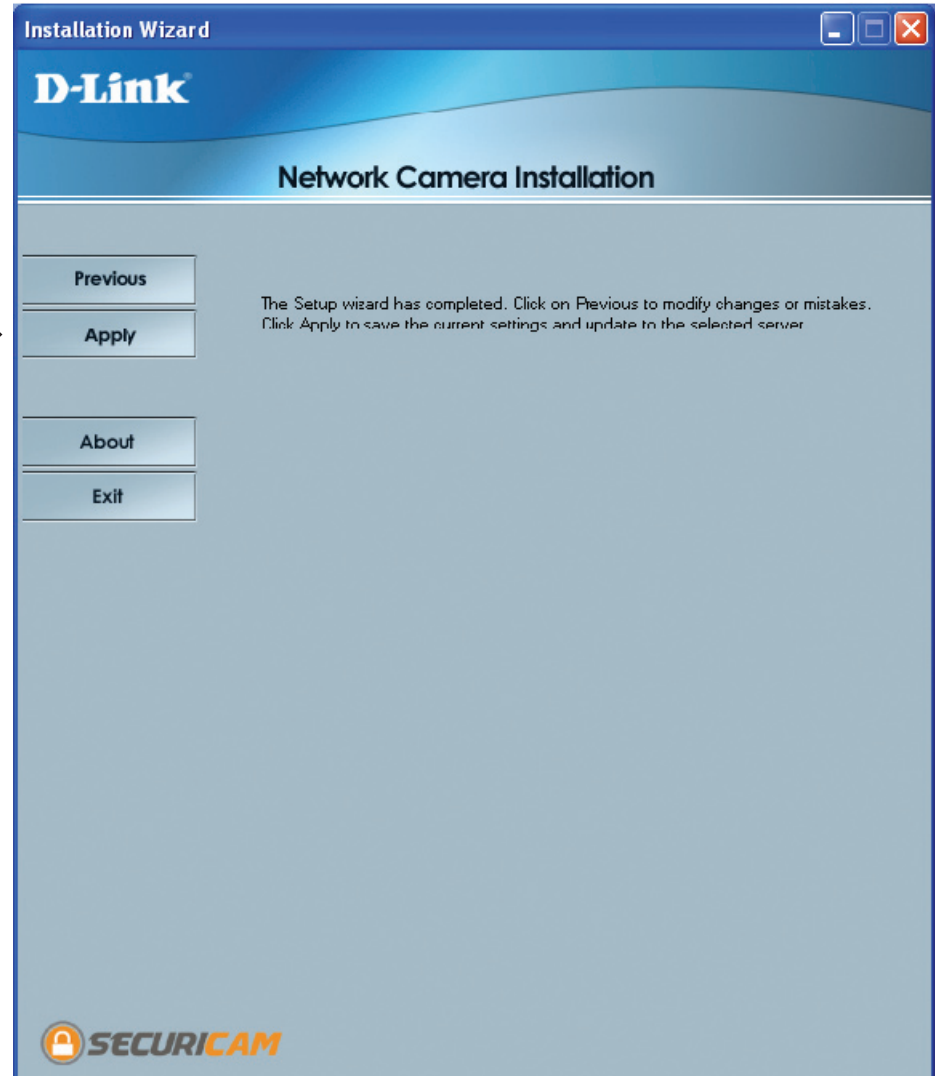

Upgrade

The upgrade window allows users to upload the firmware. If the firmware is older than the current one on the camera, a screen shot will appear indicating this, prompting the user to confirm the uploading.

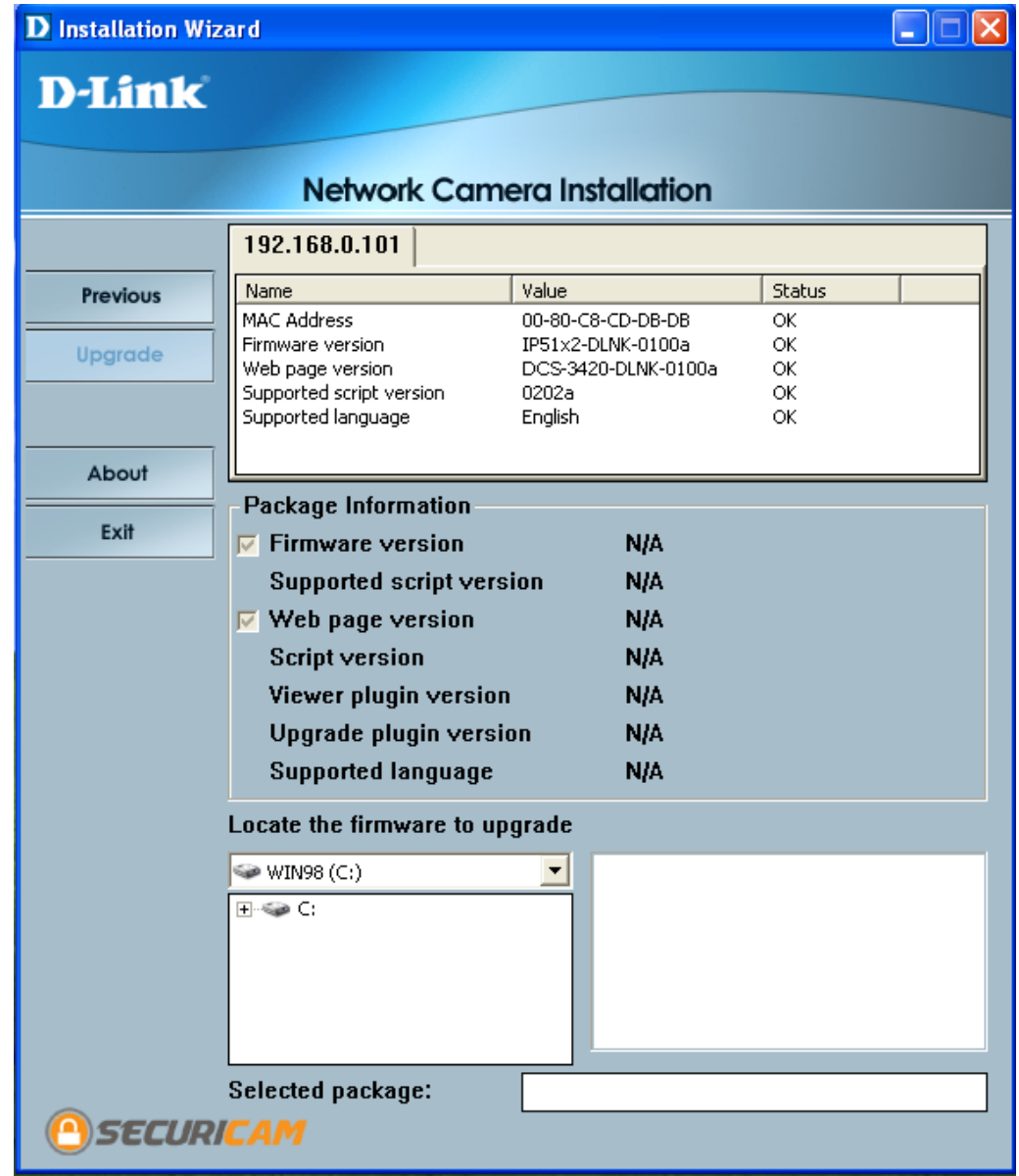

Enabling UPnP for Windows® XP

UPnP (Universal Plug and Play) is a networking architecture that provides compatibility among networking equipment, software, and peripherals. The DCS-3420 is an UPnP enabled Internet camera. If your operating system is UPnP enabled, the device will be easier to configure. If you do not want to use the UPnP functionality, it can be disabled by unchecking the **Enabled UPnP** checkbox in the **Advanced > Network** page (see page 33). Use the following steps to enable UPnP settings only if you are running Windows® XP. If you are running Windows® 98/2000, UPnP is not available.

Go to **Start >Settings**. Click Control Panel.

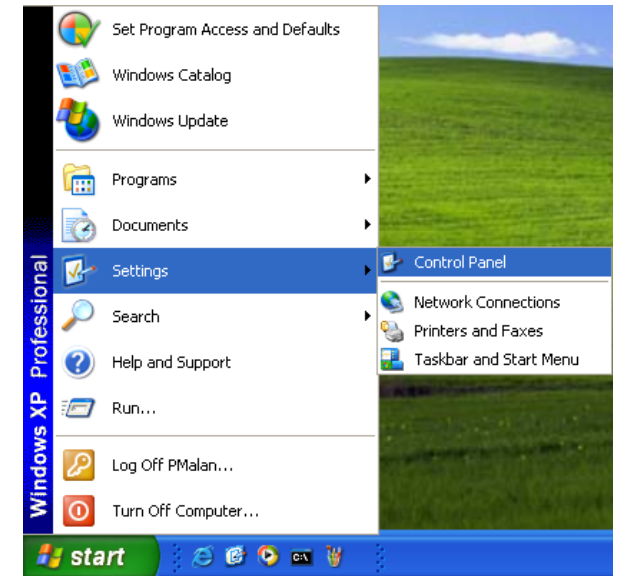

Click **Add or Remove Programs**

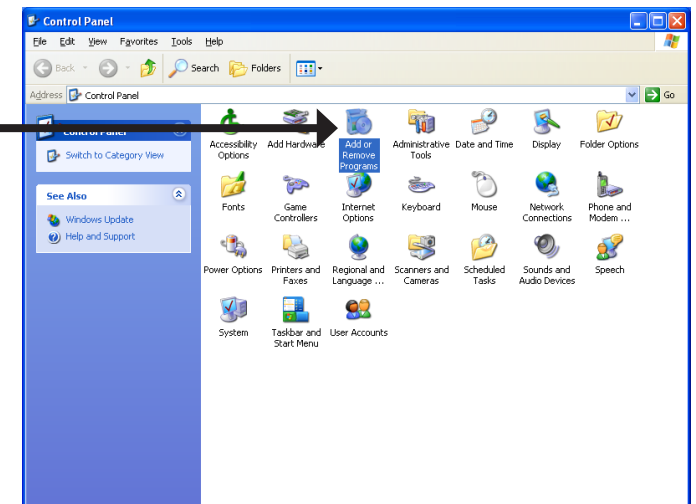

Click **Add/Remove Windows Components**

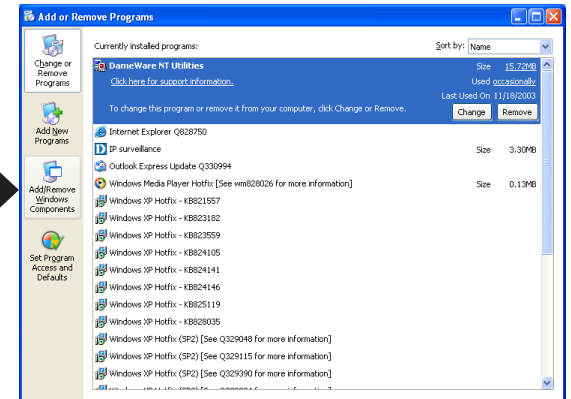

The following screen will appear.

Select **Networking Services**.

Click **Details**

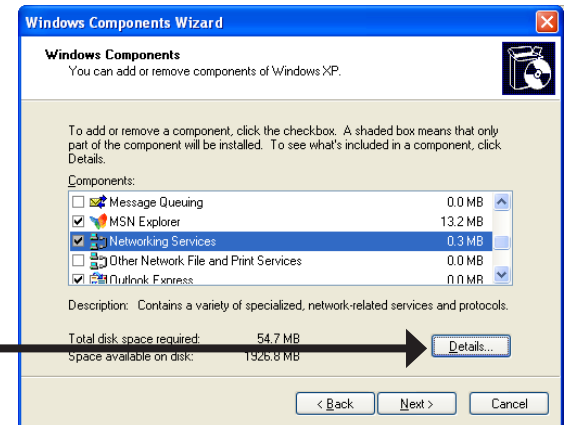

Select **Universal Plug and Play**.

Click **OK**

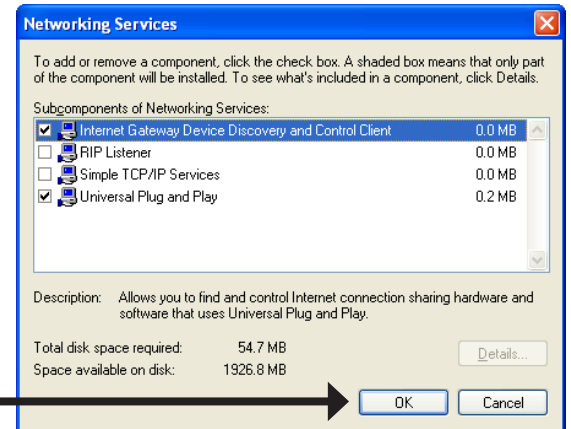

Click Next

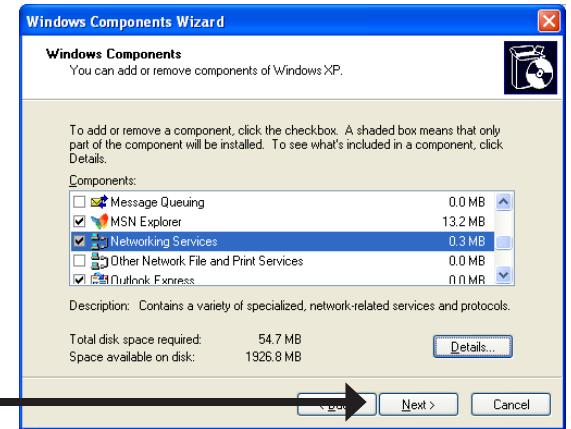

Please wait while Setup configures the components.

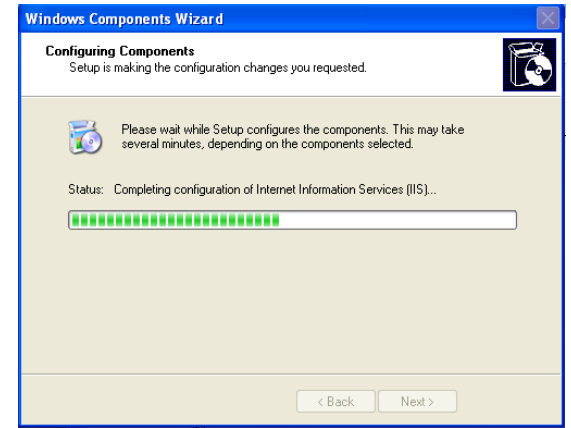

Click Finish



To view your DCS-3420 Internet Camera in an Internet browser, go to your Desktop and click **My Network Places**.



The last three digits (120), represent the fourth octet of your Internet Camera's IP address (in this example, 198.168.0.120). Click **DCS-3420-120**.

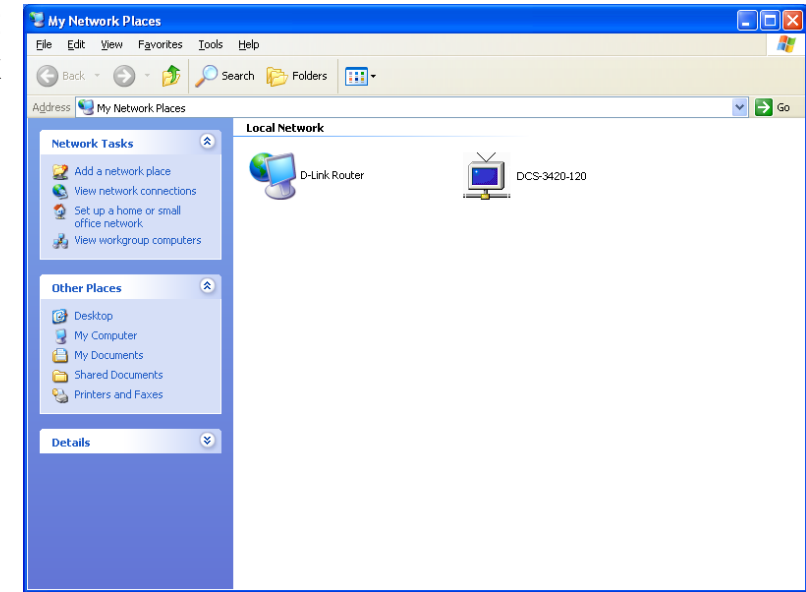

After you click on the DCS-3420 icon, your Internet browser will automatically be opened to the IP Address of the DCS-3420, in this example it is: <http://192.168.0.120>. Your DCS-3420 may have a different IP Address.



(Note: Screen shots are taken in Windows® XP, similar screens will appear in Windows® 2000.)

Testing the DCS-3420

Open your Internet browser and type in the IP address of the DCS-3420. In this example, the address is: <http://192.168.0.120> (your DCS-3420 may have a different IP address based on what you used in the Installation Wizard program).

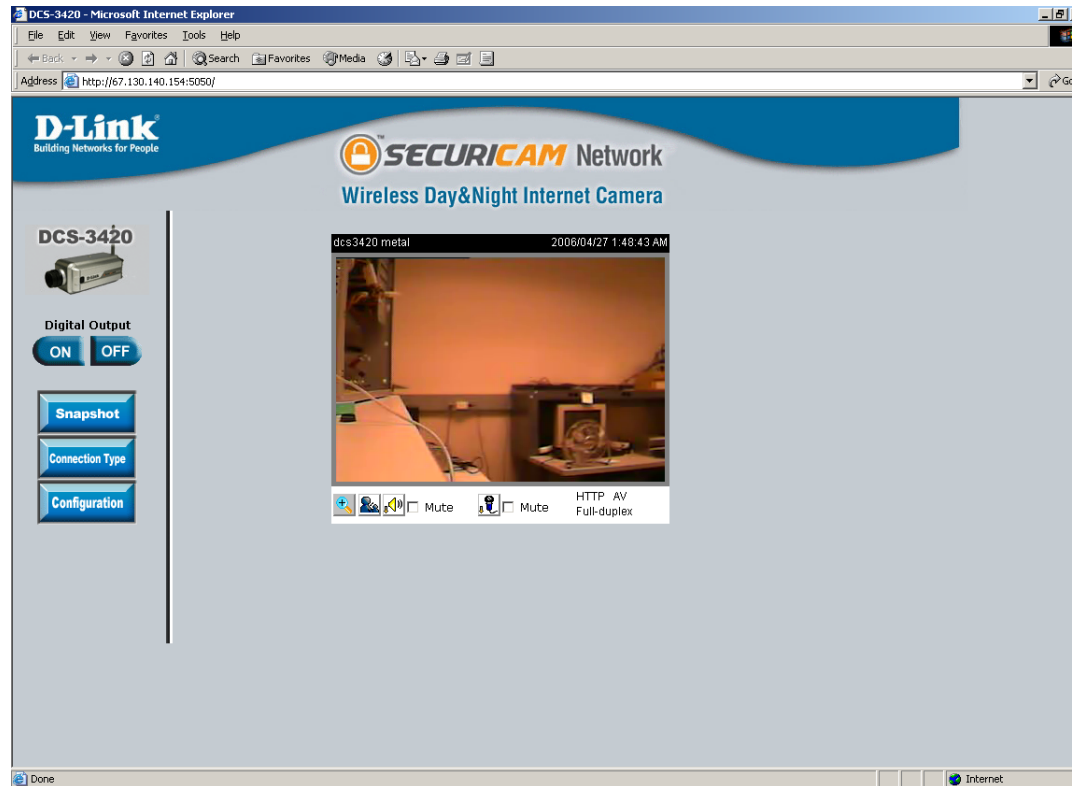

The window in the center of your browser is the camera image window. You should now see a video image and hear the audio over your computer speakers from the DCS-3420. If you are having problems, please consult the Troubleshooting section of this manual (page 131).

Viewing Your DCS-3420

After all the router settings have been entered correctly, a PC user inside or outside your network will have access to the camera through the Internet Explorer Web browser. To access the camera from the Internet, type the IP Address of the router given to you by your ISP, followed by a colon, and the port number that you gave your camera (e.g., `http://70.42.15.9:83`). It is not necessary to enter the colon and port number if you are using the default Web server port 80. To access from a computer on your local (home) network, simply enter the local IP Address of the Camera followed by a colon and the port number (e.g., `http://192.168.0.120:83`).

If you are following this manual in the order it is presented, you should now have an operating DCS-3420 Internet Camera configured with the Installer program. You also have installed the IP surveillance software from the CD. This section of the manual will cover how to use the Internet Camera in two methods:

- Using the DCS-3420 with an Internet browser and accessing the screens to control and monitor the camera.
- Using IP surveillance software with the DCS-3420.

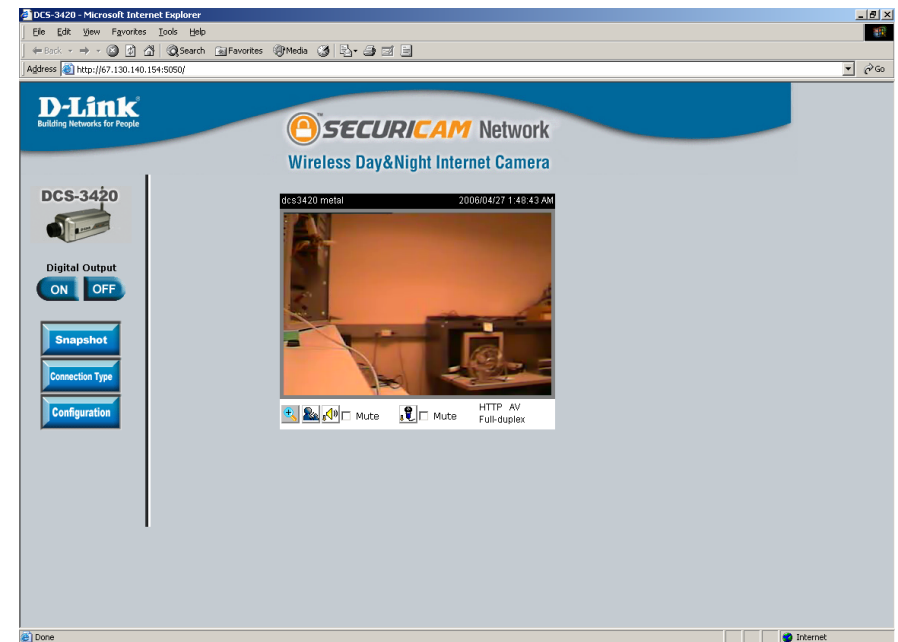

Using the DCS-3420 with an Internet Browser

Open your Internet Explorer Web browser and enter the IP address for your Internet Camera (<http://192.168.0.120>).

In the example, this address is 192.168.0.120. Your address may differ.

If a window appears asking to install a Verisign certificate for authentication Click Yes. This allows the proprietary MPEG4 video stream to be recognized by Internet Explorer.



Home

Snapshot: Click to capture a snapshot image. The image will pop up in a new window. This image can be saved to a local hard drive.

Connection Type: Click on the Connection Type button to change settings related to the camera connection.

Configuration: Click on the Configuration button to access the configuration menu where you can configure camera settings under the Advanced, Tools, and Status tabs.

Push/Toggle: Push to enable the speaker. You can set the speaker button operation to either Push or Toggle on the Connection Type screen.

Speaker Volume Control: Click to increase or decrease speaker volume.

Mute Speaker: Click to mute the speaker.

Microphone Volume Control: Click to increase or decrease microphone volume.

Mute Microphone: Click to mute the camera's microphone.



Connection Type

Disable Audio: Option for users to disable or enable audio when viewing video.

Speaker Button Operation: If Push is selected, the user must push and hold the speaker button each time to speak. If Toggle is selected, pushing the speaker button turns the speaker function on and it remains on until the user toggles the button off.

Protocol Option: The UDP Protocol should be chosen for the most users. Generally, the client computer will automatically try these protocols in the following order, UDP -> TCP. After the client connects to the DCS-3420 successfully, the working protocol will be displayed in Protocol Option. The chosen protocol will be saved in the user's PC and used for the next connection. If the network environment is changed or users want to let the Web browser automatically detect the protocol, select UDP manually and click Save to change the setting and return Home to reconnect with the new setting.

Options:

UDP Protocol - Allows for more real-time audio and video streams. However, packets may be dropped and images obscured due to network burst traffic.

HTTP Protocol - This protocol must be selected if the network is protected by a firewall that only allows the HTTP Port (80) to be opened. If the user's network does not require the use of a firewall, the UDP protocol is recommended.

Click the **Home** tab to return to the **DCS-3420** Home page.

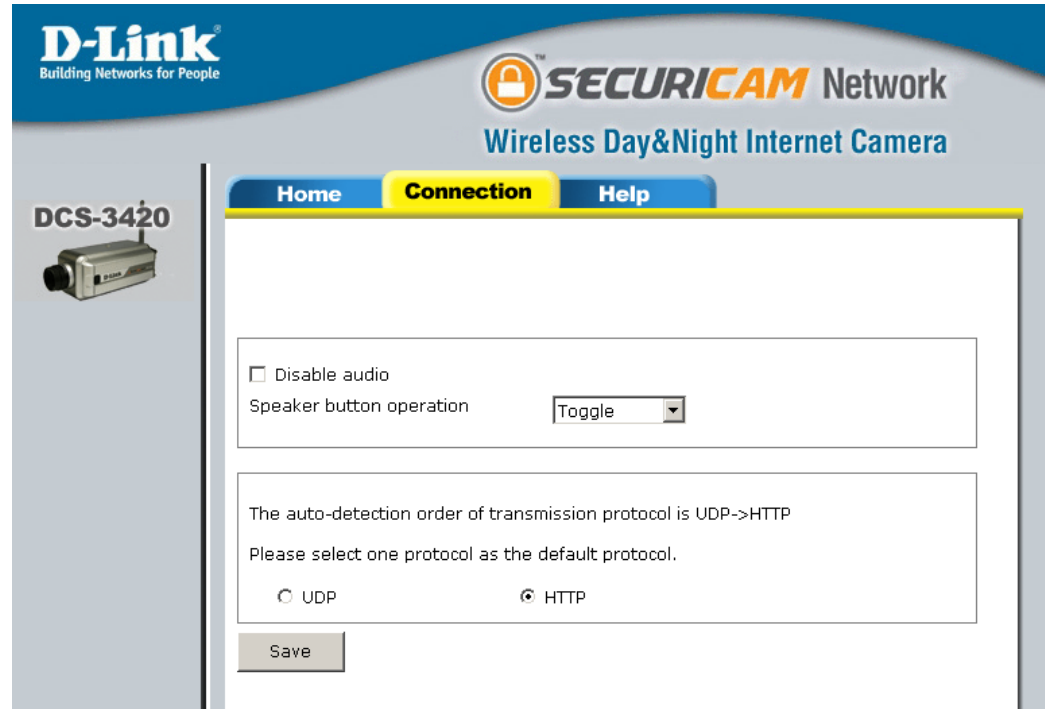

Advanced Network

IP Address: Necessary for network identification.

Subnet Mask: Used to determine if the destination is the same subnet. The default value is “255.255.255.0.”

Default Router: The router used to forward frames to destinations in a different subnet. Invalid router settings may cause the failure of transmissions to a different subnet.

Primary DNS: Primary domain name server that translates names to IP addresses.

Secondary DNS: Secondary domain name server to backup the primary one.

PPPoE: (Point-to-Point Protocol over Ethernet) Select this option if the camera is directly connected to the Internet through a DSL modem, and the ISP (Internet Service Provider) requires you to use PPPoE for the Internet connection. Input the authentication information from your ISP into these fields. Note: The Internet (WAN) IP Address of the PPPoE will be sent through the email.

D-Link
Building Networks for People

SECURICAM Network
Wireless Day&Night Internet Camera

Home **Advanced** Tools Status Help

DCS-3420

Network
Wireless
Mail&FTP
DDNS&UPnP
Video
Audio
Image Setting
Motion Detection

Network settings

Network type

LAN

Reset the IP address at next boot

IP address

Subnet mask

Default router

Primary DNS

Secondary DNS

PPPoE

User name

Password

Confirm password

HTTP

HTTP port

Streaming

UDP Audio channel port

UDP Video channel port

HTTP Port: Can be set to other than the default port 80. When the administrator changes the HTTP port of the DCS-3420 (which has an IP address of **192.168.0.120**) from 80 to 8080, users must type **http://192.168.0.120:8080** in the web browser bar to bring up the web interface.

UDP audio port: Can be set to a port other than the default port **5002**. A corresponding port must be opened on your firewall.

UDP video port: Can be set to a port other than the default port **5003**. A corresponding port must be opened on your firewall.

Wireless

SSID: (Service Set Identifier) is a name that identifies a wireless network. Access Points and wireless clients attempting to connect to a specific WLAN (Wireless Local Area Network) must use the same SSID. The default setting is default.

Wireless Mode: Click on the pull-down menu; select from the following options: Infrastructure - to connect the WLAN using an Access Point such as the DWL-1000AP+ or a DI-614+ wireless router. (The default setting.) Ad-Hoc – wireless mode used when connecting directly to a computer equipped with a wireless adapter in a peer-to-peer environment.

Channel: The default wireless channel setting is channel 6. Select the channel that is the same as the other wireless devices on your network.

TX Rate: Select the transmission rate on the network. Auto is the default setting.

Preamble: Select Long or Short Preamble. The Preamble defines the length of the CRC block (Cyclic Redundancy Check is a common technique for detecting data transmission errors) for communication between the Access Point and the roaming wireless Network adapters. Short Preamble is the default setting. Note: High network traffic areas should use the shorter preamble type.

The screenshot displays the D-Link Securicam Network configuration page for a DCS-3420 camera. The 'Advanced' tab is active, and the 'Wireless settings' section is expanded to show 'WLAN Configuration'. The configuration includes:

- SSID: dlink
- Wireless mode: Infrastructure
- Channel: 6
- TX rate: Auto
- Preamble: Short preamble
- Security: None
- Pre-shared key: 00000000
- Auth mode: Open
- Key length: 64 bits
- Key format: HEX
- Default key: Network key (with four asterisks)

At the bottom right, there are 'Apply' and 'Cancel' buttons.

Security: Select the encryption type from the drop-down list. The default setting for the encryption is None, which means the security is disabled.

Pre-shared Key: This Key allows the camera to connect to other devices by using WPA-PSK encryption. Pre-shared key must be 8-63 characters or 64 hex characters.

Auth mode: Choose one of the following authorization modes: Open Authentication- Communicates the key across the network. Shared Authentication- Allows communication only with other devices with identical WEP settings.

Key Length: Select the key length, either 64 or 128 bits.

Key Format: Select an ASCII or hexadecimal key format.

Default Key: You can create up to 4 different security keys.

Mail & FTP

SMTP (mail) server 1: The domain name or IP address of the external mail server.

SMTP account name 1: The user name used to log into your e-mail account (e.g. jdoe or jdoe@yourisp.com depending on your ISP).

SMTP password 1: The password used to log into your e-mail account. (The password will appear as dots instead of entered characters.)

Recipient email address 1: The e-mail address of recipients for snapshots or a system log file.

SMTP (mail) sever 2: The domain name or IP address of a secondary mail server used only if the primary mail server is unreachable.

SMTP account name 2: The user name for the second SMTP server.

SMTP password 2: The password used to log into the second e-mail account. (The password will appear as dots instead of entered characters.)

Recipient email address: The e-mail address of recipients for the secondary server.

D-Link
Building Networks for People

SECURICAM Network
Wireless Day&Night Internet Camera

Home **Advanced** Tools Status Help

DCS-3420

Network
Wireless
Mail&FTP
DDNS&UPnP
Video
Audio
Image Setting
Motion Detection

Mail & FTP settings

SMTP

1st SMTP (mail) server

1st SMTP account name

1st SMTP password

1st recipient email address

2nd SMTP (mail) server

2nd SMTP account name

2nd SMTP password

2nd recipient email address

Sender email address

FTP

Local FTP server port

1st FTP server

1st FTP server port

1st FTP user name

1st FTP password

1st FTP remote folder

1st FTP passive mode

2nd FTP server

2nd FTP server port

2nd FTP user name

2nd FTP password

2nd FTP remote folder

2nd FTP passive mode

Sender Email The sender's email address that appears in the mail alert.

Address:

Local FTP server port: It can be other than default port 21. If you find that you want to change the port to a port number other than 21, you will need to specify the port when connecting to the FTP server. For example FTP://68.5.1.81:60 (if you are to use port 60 for your FTP server port)

1st FTP server: The host name of the FTP server.

1st FTP server port: The port of the FTP server. Usually the port number of FTP server is 21. It depends on the FTP server's setup.

1st FTP user name: The account name to access the FTP server.

1st FTP password: The password that was setup with the account to access the FTP server.

1st FTP remote folder: The directory that the images will be uploaded into (For example, \pub\images).

1st FTP Passive Mode: Allows access to an external FTP sever if your camera is behind a router protected by a firewall.

2nd FTP server: The 2nd FTP server serves as a backup FTP server.

2nd FTP user name: The account name to access the FTP server.

2nd FTP password: The password that was setup with the account to access the FTP server.

2nd FTP remote folder: The directory that the images will be uploaded into (For example, \pub\images).

2nd FTP passive mode: Passive mode setting for the backup FTP server.

DDNS & UPnP

DDNS: Dynamic DNS (Domain Name Service) is a method of keeping a domain name linked to a changing (dynamic) IP address. With most Cable and DSL connections, you are assigned a dynamic IP address and that address is used only for the duration of that specific connection. With the DCS-3420, you can set up your DDNS service and the DCS-3420 will automatically update your DDNS server every time it receives a different IP address.

Enable DDNS: Check to enable the DDNS function.

Provider: Select your Dynamic DNS provider from the drop down menu.

Host Name: Enter the host name of the DDNS server.

Username/E-mail: Enter your username or e-mail used to connect to the DDNS server.

The screenshot shows the web interface for the D-Link DCS-3420 camera. The main header includes the D-Link logo and 'SECURICAM Network Wireless Day&Night Internet Camera'. A navigation bar has tabs for Home, Advanced (selected), Tools, Status, and Help. On the left, a sidebar lists menu items: Network, Wireless, Mail&FTP, DDNS&UPnP (highlighted), Video, Audio, Image Setting, and Motion Detection. The main content area is titled 'DDNS & UPnP settings'. Under 'Dynamic DNS', there is an unchecked checkbox for 'Enable DDNS', a dropdown menu for 'Provider' set to 'DynDNS.org(Dynamic)', and three text input fields for 'Host name', 'Username/E-mail', and 'Password/Key'. Under 'Universal PnP', there is a checked checkbox for 'Enable UPnP'. At the bottom right, there are 'Apply' and 'Cancel' buttons.

Password/Key: Enter your password or key used to connect to the DDNS server.

UPnP: UPnP is short for Universal Plug and Play, which is a networking architecture that provides compatibility among networking equipment, software, and peripherals. The DCS-3420 is a UPnP enabled Internet camera. If your operating system is UPnP enabled, the device will be easier to configure. If you do not want to use the UPnP functionality, it can be disabled by unselecting the **Enable UPnP** check box.

Color: Select the option for color or monochrome video display.

Size: Three options exist for the video display: 176 x 120, 352 x 240, and 704 x 480. In 704x480 mode, the frame rate will be reduced to 10fps and increased to 30fps automatically when it is switched back to a lower image size.

Maximum frame rate: Limits the maximum refresh frame rate. The frame rate is used with the **Video quality control** setting (below) to optimize bandwidth utilization and video quality.

Key Frame Interval: The keyframe interval value tells the camera how often to re-evaluate the video image and record a full frame, or keyframe, into the video stream.

Video

The screenshot shows the configuration interface for a D-Link DCS-3420 camera. The interface is titled "D-Link Building Networks for People" and "SECURICAM Network Wireless Day&Night Internet Camera". The "Advanced" tab is selected, and the "Video settings" section is active. The settings are as follows:

- Color:** COLOR (dropdown menu)
- Size:** 352x240/352x288 (dropdown menu)
- Maximum frame rate:** 30 (dropdown menu)
- Video codec type:** MPEG4 (dropdown menu)
- Key frame interval:** 120 (dropdown menu)
- Video quality control:**
 - Fix bit rate (384 Kbps dropdown menu)
 - Fix quality (Good dropdown menu)
- Flip
- Mirror
- Improve efficiency in the multi-user environment
- Timestamp on video

At the bottom right, there are "Apply" and "Cancel" buttons with green and red checkmarks respectively. On the left side of the interface, there is a navigation menu with buttons for Network, Wireless, Mail&FTP, DDNS&UPnP, Video (highlighted), Audio, Image Setting, and Motion Detection. A small image of the DCS-3420 camera is also visible above the navigation menu.

Video quality control: To fix the bandwidth utilization regardless of the video quality, choose **Fix bit rate** and select the desired bandwidth. The video quality may be reduced in order to send maximum frames with limited bandwidth, especially when images change drastically. For higher video detail regardless of the bandwidth selection, select **Fix quality** and select a video quality level. This setting will utilize more bandwidth to send the maximum frames when images change drastically.

Flip: Vertically rotate the video.

Mirror: Horizontally rotate the video. Check both **flip** and **mirror** if the DCS-3420 is to be installed upside down.

Improve efficiency in the multi-user environment: If the camera works in a multi-user environment, the user can enable this option to conserve bandwidth by reducing video capture rate.

Timestamp on video: Select this option to display the current date and time on the video image. All the snapshots and video data will have the date and time locate on the corner of the picture.

Recommendations for Setting Video for the Best Performance:

“Best performance” means the image refresh rate should be the fastest possible and the video quality should be the best possible at the lowest network bandwidth possible. Three factors, Maximum frame rate, Fix bit rate, and Fix quality in the Video Configuration page, are related to performance.

Recording settings for real-time motion images

To achieve a real-time visual effect, the network bandwidth should be large enough to transmit 20 image frames per second (fps) or more. If you are on a broadband network over 1 Mbps, you can set Fix bit Rate to 1000Kbps or 1200Kbps, or set Fix quality to achieve the maximum frames. The maximum frame rate is 25 in 50Hz system and 30 in 60Hz system. If your network bandwidth is more than 384Kbps, you can adjust Fix bit rate according to your bandwidth and set the maximum frame rate of 25 to 30.

If the images vary dramatically in your environment, you may slow down the maximum frame rate to 20 to decrease the transmitted data for better video quality. Since the human eye could not easily differentiate between 20 and 25 or 30 frames per second, the slower frame rate will not be noticed. If your network bandwidth is below 384 Kbps, you should adjust the bit rate according to your bandwidth and experiment to allow for the best frame rate that can be achieved. The faster frame rate in a slow network will blur the images. You may also try to choose 320x240 in size option for better images or 640x480 for larger image size. Because the network has burst constraints and everyone’s environment is not the same, any poor connection will impair normal performance.

Recording settings for clear identification for each image

To have the best video quality, you should set Fix quality to detailed or excellent and tune the Maximum frame rate to suit your network bandwidth. If you get some broken pictures in a slow network, you can set TCP protocol in Connection type for a more accurate transmission but the received images may have a lag. Note that any slow connection with multiple users will impair performance.

Recording settings to compromise between real-time and clear images

If you have a broadband network, set Fix quality to Good image quality, or higher, instead of setting the Bit rate. Otherwise, fix the bit rate according to your actual network speed and set the frame rate to 30. If the image quality is low, select a lower frame rate above 15. If the image quality is still not improved, select a lower bit rate.

Audio

Transmission mode: There are five options to select. For all the modes, only one client can talk to the server at the same time.

Full-duplex: The User can talk to and listen from the server simultaneously.

Half-duplex: The User can talk to the server or listen from the server, but not at the same time.

Simplex/Talk only: The User can only talk to the server.

Simplex/Listen only: The User can only listen from the server.

Disable: The audio is disabled in both directions.

Improve audio quality in low bandwidth environment: If the Network Camera works in a low bandwidth network environment, the User can check this option to improve audio quality by sacrificing some real-time synchronization.

Bit rate: There are three bit rates for audio. 32Kbps and 24Kbps are suitable for both music and speech and 8Kbps is suitable for speech only.

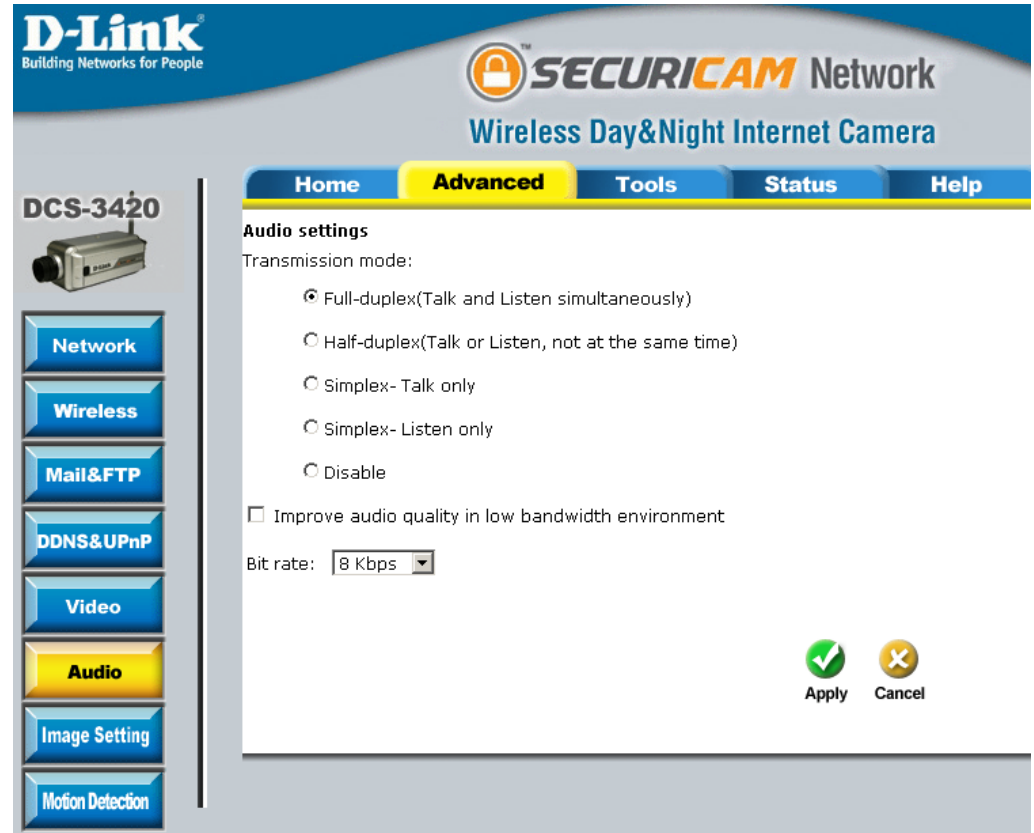

Image Setting



From this screen you can fine tune the video image.

Image Brightness, Contrast, Saturation and Hue are all adjustable in the same manner. For each video compensation, you can set from among eleven levels ranged from -5 to +5. The default setting is zero for each adjustment.

You may use the **Preview** and **Restore** button to fine-tune the image. Press the **Save** button to store the image settings, or press the **Restore** button to recall the original settings. If settings are changed without saving, they will be effective until the next system start-up.

Motion Detection

Enable motion detection: Check this option to turn on the motion detection.

Window name: The name of the motion detection window.

Sensitivity: Sensitivity meter allows the user to set how sensitive for the motion triggering. The sensitivity is based on pixel change of the video image.

Percentage: Percentage meter allows use to specify how many percentage of the motion screen is changed to trigger the motion detection. Lower percentage gives higher sensitivity of the motion detection.

New: Adds new windows that monitor specific area of the image window. Up to 3 motion detection windows can be added.

Save: Saves the new windows settings.

A green bar means the image variation is under the monitoring level, and no motion detection alert is triggered. A red bar means the image variation is over the monitoring level and a motion detected alert is triggered. When the bar goes red, the window that the motion is detected in will also be outlined in red (note: remember that you can have up to 3 windows selected for motion detection). You can return to the DCS-3420 Home Page and the monitored window will not be visible, but the red frame will show on the home page when motion is detected.

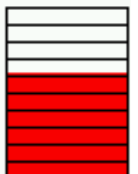

Tools Admin

The DCS-3420 is designed without any passwords by default. This allows the ability to access the DCS-3420 (including the Configuration) by anyone as long as the IP address is known. It is recommended that you enter a password to restrict others from accessing your camera.

Type a password in the Admin Password field to enable protection, and then confirm the password in Confirm Password field.

This password is used to identify the administrator. You can add accounts with User name and User Password for other users in the **Add user** section. 20 user accounts can be added in maximum.

The screenshot shows the D-Link Securicam Network administration interface. The top navigation bar includes 'Home', 'Advanced', 'Tools' (selected), 'Status', and 'Help'. The left sidebar shows 'DCS-3420' with a camera icon and four menu items: 'Admin' (highlighted), 'System', 'Applications', and 'Default'. The main content area is titled 'Administrator settings' and contains the following sections:

- Administrator's password:** Fields for 'New password' and 'Confirm password', with a 'Save' button.
- Add user:** Fields for 'User name' and 'User password', and checkboxes for 'I/O access', 'Talk', and 'Listen', with an 'Add' button.
- Manage user:** A 'User name' dropdown menu (currently showing '-- no user --') and 'delete' and 'edit' buttons.
- Guest account:** A checkbox labeled 'Allow 'demo' account to view'.

Guest Account: This option allows a user to connect to a camera with view-only privileges. User name is demo. No password is required. This is useful for demonstrations and keeps guests separate from users with accounts.

System

Camera name: This name will be used to identify your camera. Text entered will be displayed in the black bar above the video window with a timestamp set in the date and time section.

Turn off the LED Indicator: Check this option to turn off the LED next to the lens. This will prevent anyone from observing the operation of the Internet Camera.

Keep current date and time: Click to save the current date and time of DCS-3420. An internal real-time clock maintains the date and time even when the power is off.

Sync with computer time: Synchronizes the date and time of your camera with your computer.

Manual: Adjust the date and time according to what is entered by the administrator.

Automatic: Synchronize with the NTP server over the Internet whenever the **DCS-3420** starts up.

NTP Server: The IP address or domain name of the timeserver. Leaving the text box blank will let the DCS-3420 connect to the default time servers.

Time Zone: Used to adjust the hour of time servers for local settings.

The screenshot shows the D-Link DCS-3420 Web Interface. The page title is "SECURICAM Network Wireless Day&Night Internet Camera". The navigation tabs are Home, Advanced, Tools (selected), Status, and Help. The left sidebar shows the camera model "DCS-3420" and navigation buttons for Admin, System (selected), Applications, and Default. The main content area is titled "System settings" and contains the following configuration options:

- Camera name:** dcs3420 metal
- Turn off the LED indicator
- Automatically restore DO state after 1 second(s)
- Display number of concurrent users
- Keep current date and time
- Sync with computer time
 - PC date: 2006/04/26 [yyyy/mm/dd]
 - PC time: 11:09:36 [hh:mm:ss]
- Manual
 - Date: 2006/04/27 [yyyy/mm/dd]
 - Time: 02:11:26 [hh:mm:ss]
- Automatic
 - NTP server: skip to invoke default server
 - Time zone: GMT+8:00
 - Update interval: One hour

At the bottom right, there are "Apply" and "Cancel" buttons.

Applications

Sunday through Saturday: Select the day(s) according to when you want your camera to take the snapshots.

Snapshots begin at: Sets the time to start taking snapshots.

Snapshot stop at: Sets the time to stop taking snapshots.

All the time except for the above schedule: Sets the camera to take snapshots all the time except for the times scheduled.

Snapshot Interval: The camera will send snapshots at the specified intervals to the external server.

Delay second(s) before detecting next event: Sets the time delay between triggered events.



D-Link
Building Networks for People

SECURICAM Network
Wireless Day&Night Internet Camera

Home Advanced **Tools** Status Help

Applications settings

DCS-3420

Admin
System
Applications
Default

Weekly schedule

Sun Mon Tue Wed Thu Fri Sat

snapshots begin at [00:00:00] [hh:mm:ss]

snapshots stop at [00:00:00] [hh:mm:ss]

All the time except for the above schedule

Snapshot interval: [1] second(s)

Event operation

General

Delay [3] second(s) before detecting the next event

Trigger condition

Input is high Input is low

Input is rising Input is falling

Detect motion in :

Note: **Motion detection** must be setup first

Trigger action

Trigger output alarm while input condition matched

Trigger output alarm while motion detected

Upload snapshots while input condition matched

Upload snapshots while motion detected

Reset output

Sequential operation

Send snapshots by email

Send snapshots by FTP

FTP put snapshots with date and time suffix

Apply Cancel

Trigger Condition: There are four conditions related to the digital input and up to three windows for motion detection. There can be multiple selections. Select the appropriate digital input condition according to the characteristics of the external device. **High** or **low** indicate external voltage input for level trigger, while **rising** or **falling** is for edge triggers. There are three windows shown for the names you defined for motion detection. **Undefined** will show instead of the window title if motion detection is not setup yet. An active, named motion window must be checked for motion detection operation.

Trigger Action: Trigger action defines what action the camera will take after the trigger condition is matched. The camera will be able to trigger output alarm (optimal requires Digital Outout setup. Please refer to page 57 for more information.) or upload the snapshots.

Reset Output: Check and save this option to reset the external device at the digital output back to the original state.

Sequential operation: The camera will send snapshots to the external server (FTP, Email) continuously, based on the snapshot interval. These settings will correspond with the Weekly Schedule (Sun ~ Mon) that is specified in Applications settings.

Send snapshots by email: Any upload action specified in the options above will use the method chosen here. The captured snapshot named "video.jpg" will be attached in the email with subject "Periodic snapshots."

Send snapshots by FTP: The captured snapshots will upload to the external FTP server with the file name depending on the "FTP put snapshots with date and time suffix" option.

FTP put snapshots with date and time suffix: If the suffix is added, the captured date and time can be easily differentiated from the snapshot file name in either sequential or event operation. For instance, "video@20020102030405.jpg" means the JPEG image was captured at 4 minutes and 5 seconds after 3 o'clock, January 2nd, A.D. 2002. If the suffix is omitted, the file named "video.jpg" on the external FTP server will be refreshed at the specified interval.

Default

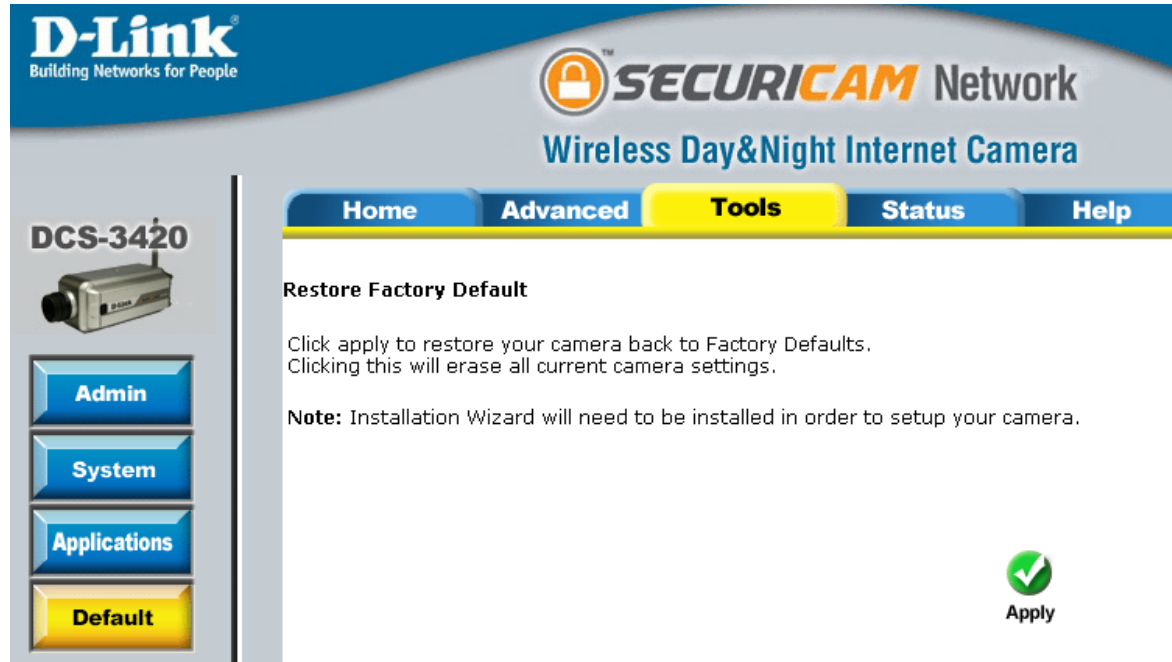

Click **Apply** on this screen to restore the factory default settings. After confirmation, the system will restart and require the **Installation Wizard** software program to locate the IP address of the DCS-3420.

For hard reset, please refer to page 7.

Status

Device Info

The screenshot shows the web interface for a D-Link DCS-3420 camera. The top header includes the D-Link logo and the product name 'SECURICAM Network Wireless Day&Night Internet Camera'. A navigation bar contains tabs for Home, Advanced, Tools, Status (which is highlighted), and Help. On the left side, there is a product image of the camera, the model number 'DCS-3420', and two buttons: 'Device Info' and 'Log'. The main content area is titled 'Device information' and lists the following details:

| | |
|------------------|---------------------|
| Firmware Version | : 1.00 |
| Mac Address | : 00-80-C8-CD-E2-22 |
| IP address | : 192.168.0.191 |
| Subnet mask | : 255.255.255.0 |
| Default router | : 192.168.0.1 |
| Primary DNS | : 67.130.140.2 |
| Secondary DNS | : 4.2.2.2 |

Log

The content of the log file reveals useful information about the current configuration and connection logged after the DCS-3420 starts up.



The screenshot displays the D-Link DCS-3420 web interface. The top navigation bar includes 'Home', 'Advanced', 'Tools', 'Status' (highlighted), and 'Help'. The main content area is titled 'View system log' and contains a scrollable text box with the following log entries:

```
<2006/04/27 02:39:31>SYS: Flash file system installed!
<2006/04/27 02:39:36>NET: Use settings from DHCP
<2006/04/27 02:39:36>SYS: Network interface initialized!
<2006/04/27 02:39:36>NET: Host IP = 192.168.0.191
<2006/04/27 02:39:36>NET: Subnet Mask = 255.255.255.0
<2006/04/27 02:39:36>NET: Gateway = 192.168.0.1
<2006/04/27 02:39:36>NET: Primary DNS = 67.130.140.2
<2006/04/27 02:39:36>NET: Secondary DNS = 4.2.2.2
<2006/04/27 02:39:37>SYS: MAC address=00-80-C8-CD-E2-22
<2006/04/27 02:39:37>SYS: Stream server starts up!
<2006/04/27 02:39:37>SYS: Telnet server starts up!
<2006/04/27 02:39:37>SYS: FTP server starts up!
<2006/04/27 02:39:37>SYS: HTTP server starts up!
<2006/04/27 02:39:37>SCH: Incorrect version
<2006/04/27 02:39:39>SS: Connected by <admin(no pass)>@192.168.0.10
<2006/04/27 02:39:43>SS: Connected by <admin(no pass)>@192.168.0.10
<2006/04/27 02:39:53>SS: Connected by <admin(no pass)>@69.107.248.2
<2006/04/27 02:40:05>SS: Connected by <admin(no pass)>@192.168.0.10
<2006/04/27 02:42:53>SS: Connected by <admin(no pass)>@192.152.81.2
<2006/04/27 03:23:51>SS: Connected by <admin(no pass)>@192.152.81.1
```

Help

The help page provides detailed information of the camera's web interface.



Record Snapshots to your FTP server

Administrators can combine options on the application page to perform many useful security applications. To upload the snapshots, users can choose either email or FTP according to the user's needs. Both e-mail and FTP use the network settings on the network page. This section describes how to enable motion detecting and record snapshots to an FTP server.

Administrators can utilize the built-in motion detection to monitor any abnormal movement and then record the snapshots to a FTP server.

In this window, follow the steps below to ensure that motion detection is correctly enabled:

- 1 Check "Enable motion detection."
- 2 Click on "New" to have a new window to monitor video.
- 3 Enter in a window name.
- 4 Tune the "Sensitivity" and "Percentage" according to the local environment. Combined higher sensitivity with lower percentage gives you high sensitivity for the motion detection.
- 5 Click on save to enable the activity display.



Next, click the Mail & FTP button under the Advanced tab to set the FTP server settings for the DCS-3420.

In this window, enter the settings for the FTP server you wish to upload the image to. Optionally, you can enter settings for a secondary backup FTP server.

Local FTP server port: The Default port is 21. To connect to an FTP server, it is recommended that you do not change the port number unless your camera is behind a router. If your camera is behind a router, you can assign any port number to this field, but you must enable port forwarding on the router. Please refer to your router manual for more information on port forwarding.

1st FTP server: If you are going to upload snapshots to an FTP server, you will need to fill in the Domain name or IP address of your internal/external FTP server such as ftp://dlink.com or ftp://192.168.0.123. (The server name and IP address will vary depending on the user.) The following user settings must be correctly configured for remote access.

1st FTP server port: The port of the FTP server. The default is 21 for an external FTP site.

1st FTP user name: Specify the user name to access the external FTP server (e.g. John Smith).

1st FTP password: Specify the password to access the external FTP server (e.g. 12345).

D-Link
Building Networks for People

SECURICAM Network
Wireless Day&Night Internet Camera

DCS-3420

Home **Advanced** Tools Status Help

Mail & FTP settings

SMTP

1st SMTP (mail) server

1st SMTP account name

1st SMTP password

1st recipient email address

2nd SMTP (mail) server

2nd SMTP account name

2nd SMTP password

2nd recipient email address

Sender email address

FTP

Local FTP server port

1st FTP server

1st FTP server port

1st FTP user name

1st FTP password

1st FTP remote folder

1st FTP passive mode

2nd FTP server

2nd FTP server port

2nd FTP user name

2nd FTP password

2nd FTP remote folder

2nd FTP passive mode

Apply Cancel

1st FTP remote folder: Specify the destination folder in the external FTP server (e.g. 123456).

Primary FTP passive mode: Passive mode will allow access to an external FTP server if your camera is behind a router protected by a firewall.

2nd FTP server: Specify the Domain name or IP address of your second external FTP server. This field is optional if you have already filled in the information for the first FTP server.

2nd FTP sever port: The port of the FTP server. The default is 21 for an external FTP site.

2nd FTP user name: Specify the user name to access your backup FTP server.

2nd FTP password: Specify the user password to your backup FTP server.

2nd FTP remote folder: Specify the destination folder on your external backup FTP server.

Secondary FTP passive mode: Passive mode will allow access to a second external FTP server if your camera is behind a router protected by a firewall.

For detailed information about each setting, please refer to Configuration > Advanced > Mail & FTP in the section titled “Using the DCS-3420 With an Internet Browser” (page 30). Click the apply button when finished.

Next, click the Applications button under the Tools tab to set the application settings for the DCS-3420.

In this window, follow the steps below to set the application settings for snapshots to be recorded to an FTP site:

1. Select the weekdays you would like to record and enter the “Snapshots begin” time and “Snapshots end” time for the weekly schedule, or select “All the time except for the above schedule” if you want to enable full time snapshot recording.
2. Check “Event operation.” Set the delay “before detecting next event” to avoid continuous false alarms following the original event. Set the “Snapshot Interval” to capture the direction of the moving object.
3. Check the window name.
4. Check “Upload snapshots while motion detected.”
5. Click “Send snapshots by FTP” and check “FTP put snapshots with date and time suffix.”
6. Click the “Apply” button to save the settings.

The screenshot shows the D-Link DCS-3420 Web UI configuration page. The page title is "SECURICAM Network Wireless Day&Night Internet Camera". The navigation tabs are Home, Advanced, Tools, Status, and Help. The "Tools" tab is selected, and the "Applications" button is highlighted in the left sidebar. The main content area is titled "Applications settings" and contains the following configuration options:

- Weekly schedule:**
 - Sun Mon Tue Wed Thu Fri Sat
 - snapshots begin at [hh:mm:ss]
 - snapshots stop at [hh:mm:ss]
 - All the time except for the above schedule
- Snapshot interval:** second(s)
- Event operation**
 - General**
 - Delay second(s) before detecting the next event
 - Trigger condition**
 - Input is high Input is low
 - Input is rising Input is falling
 - Detect motion in :
 - Note: **Motion detection** must be setup first
 - Trigger action**
 - Trigger output alarm while input condition matched
 - Trigger output alarm while motion detected
 - Upload snapshots while input condition matched
 - Upload snapshots while motion detected
 - Reset output
- Sequential operation**
 - Send snapshots by email
 - Send snapshots by FTP**
 - FTP put snapshots with date and time suffix

At the bottom right, there are two buttons: "Apply" (with a green checkmark icon) and "Cancel" (with a red X icon).

Click the apply button when finished. You are now able to record snapshots to your FTP server when motion detection is triggered.

I/O Connector

I/O Connector Definition for the Internet Camera

The DCS-3420 provides a general I/O terminal block with one digital input and one relay switch for device control. The relay switch of pin 1 and pin 2 can be used to turn the external device on or off. Pin 3 and pin 4 can be connected to an external sensor and the state of voltage will be monitored from the initial state 'LOW'

The I/O connector provides the physical interface for digital output (DO) and digital input (DI) that is used for connecting a diversity of external alarm devices to the Internet Camera such as IR-Sensors and alarm relays.

The digital input is used for connecting external alarm devices and once triggered images will be taken and e-mailed.

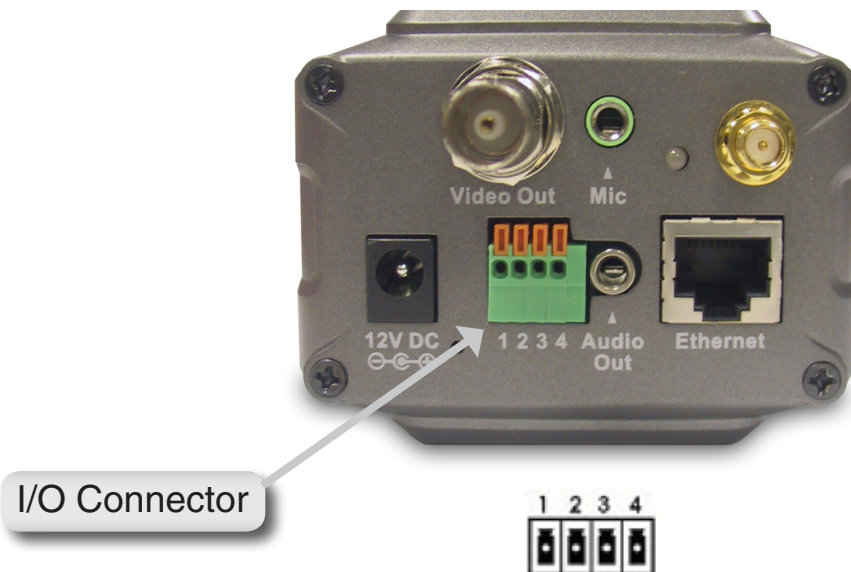

- 1 SW_COMMON OUTPUT (open from SW_OPEN at initial state)(close with SW_OPEN when set DO to ON)
- 2 SW_OPEN OUTPUT (Max. 1A, 24VDC or 0.5A, 125VAC)
- 3 DI+INPUT (Max. 50mA, 12VDC)
- 4 DI-INPUT (Initial state of DI is low)

DI/DO Connection Diagram

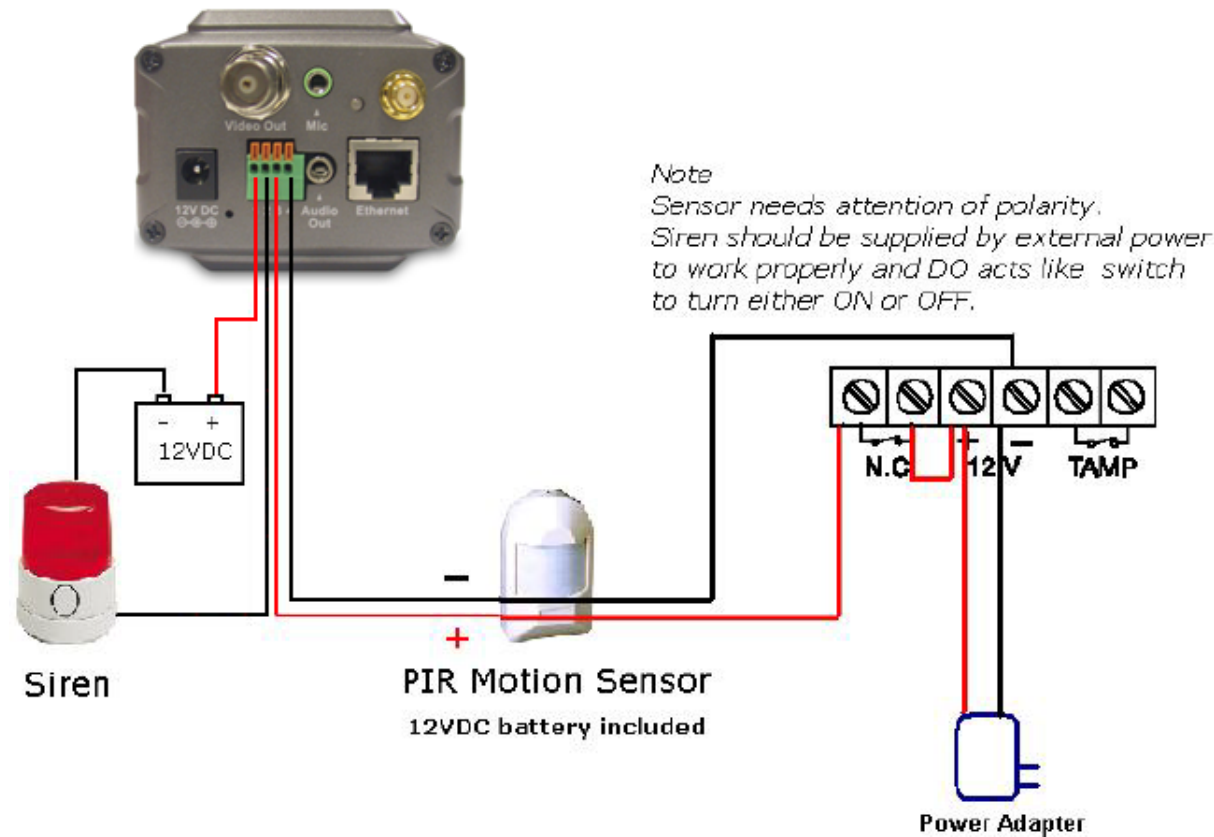

The above diagram shows a typical wiring configuration for a normally closed PIR motion sensor. Please refer to your specific motion sensor for the power supply connection to the device since this will be critical to the success of your installation. Note that the positive from the PIR is connected to the D+ of the I/O port of the camera and the negative from the PIR is connected to the D- of the camera I/O port.

Configuring Your Camera for External Trigger Based Recording

To configure your camera to record when triggered by an external device, you must first set your SMTP or FTP settings in order to send snapshots to your email account or FTP server.

Click the **Network** button under the **Advanced** tab to set the SMTP or FTP server settings for the DCS-3420.

D-Link
Building Networks for People

SECURICAM Network
Wireless Day&Night Internet Camera

Home **Advanced** Tools Status Help

DCS-3420

Network
Wireless
Mail&FTP
DDNS&UPnP
Video
Audio
Image Setting
Motion Detection

Mail & FTP settings

SMTP

1st SMTP (mail) server

1st SMTP account name

1st SMTP password

1st recipient email address

2nd SMTP (mail) server

2nd SMTP account name

2nd SMTP password

2nd recipient email address

Sender email address

FTP

Local FTP server port

1st FTP server

1st FTP server port

1st FTP user name

1st FTP password

1st FTP remote folder

1st FTP passive mode

2nd FTP server



2nd FTP server port

2nd FTP user name

2nd FTP password

2nd FTP remote folder

2nd FTP passive mode

In this window, enter the settings for the SMTP or FTP server to which recorded snapshots will be sent. For detailed information about each setting, please refer to **Configuration > Advanced > Mail & FTP** (page 37). Click the **Apply** button when finished.

Next, click the **Applications** button under the **Tools** tab to set the application settings for the DCS-3420.

In this window, follow the steps below to set the application settings for snapshots to be sent to your email account or FTP server when triggered by a motion sensor or other external device:

1. Select the weekdays you would like to record and enter the “Snapshots begin” time and “Snapshots end” time for the weekly schedule, or select “All the time except for the above schedule” if you want to enable full time snapshot recording.
2. Check “Event operation.”
3. Set the delay “before detecting next event” to avoid continuous false alarms following the original event.
4. Set the “Snapshot Interval” to capture the direction of the moving object.
5. Check the trigger condition for input and motion detection (in this case “Input is Low”).
6. Check “Trigger output alarm while input condition matched” and “Upload snapshots while motion detected.”
7. Select to either send snapshots by email or by FTP.

Click the **Apply** button when finished. You are now able to send snapshots, based on triggered recording, to your email account or FTP server.

D-Link
Building Networks for People

SECURICAM Network
Wireless Day&Night Internet Camera

Home Advanced **Tools** Status Help

Applications settings

DCS-3420

Admin
System
Applications
Default

Weekly schedule

Sun Mon Tue Wed Thu Fri Sat

snapshots begin at [00:00:00] [hh:mm:ss]

snapshots stop at [00:00:00] [hh:mm:ss]

All the time except for the above schedule

Snapshot interval: [1] second(s)

Event operation

General

Delay [3] second(s) before detecting the next event

Trigger condition

Input is high Input is low

Input is rising Input is falling

Detect motion in :

Note: **Motion detection** must be setup first

Trigger action

Trigger output alarm while input condition matched

Trigger output alarm while motion detected

Upload snapshots while input condition matched

Upload snapshots while motion detected

Reset output

Sequential operation

Send snapshots by email

Send snapshots by FTP

FTP put snapshots with date and time suffix

Adjusting the Camera Focus

The DCS-3420 Internet Camera features an interchangeable CS-type lens that can be used for different applications as necessary. It supports rotational focus control so the lens can be adjusted to focus under normal and stable conditions to maximize the image quality of the Internet Camera.

To adjust the focus of the lens you will need to turn the lens slowly either clockwise or counterclockwise until the desired image appears. **DO NOT** overturn the lens in either direction as it will be out of focus and may damage the camera. Unless you want to substitute the lens **DO NOT** unscrew more than 1.0mm apart from the Fixed Lens Assembly.

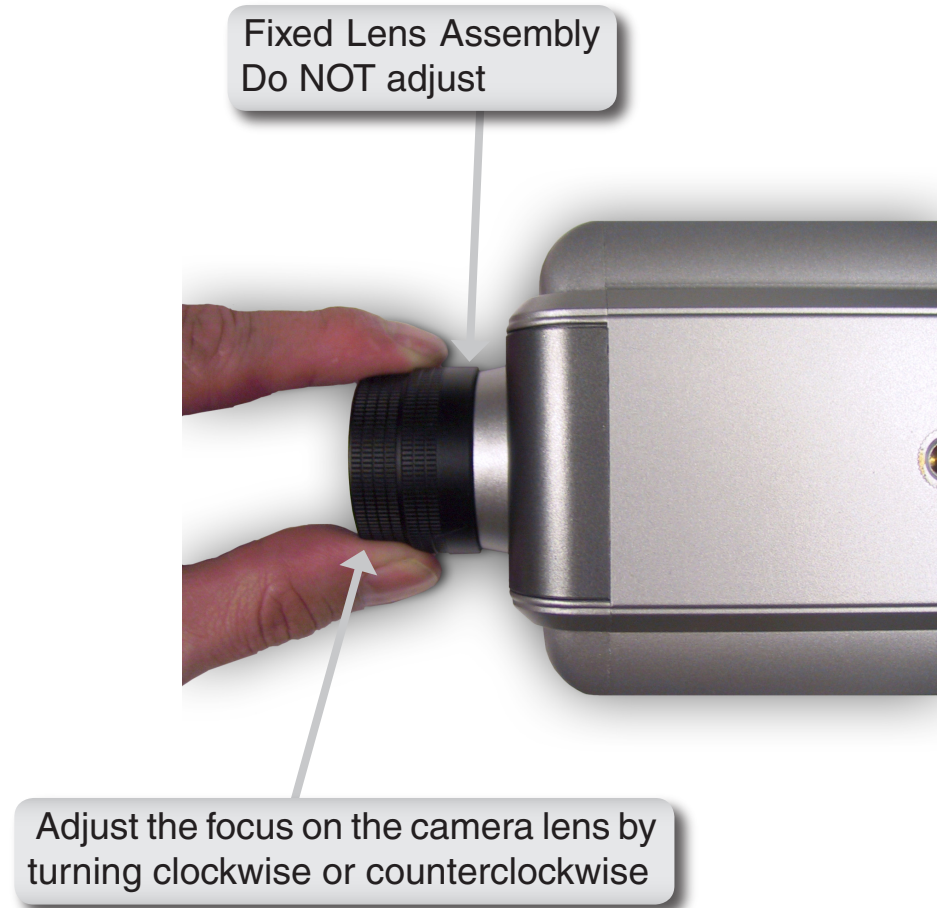

Note:

You can further adjust the Internet Camera's image quality through the web configuration under:

Configuration > Advanced > Video

Please refer to the **Configuration > Advanced > Video** section (page 40) for further details.

Replacing the Lens

Since the DCS-3420 Internet Camera is designed with a CS-mount, the lens equipped with the Internet Camera can be replaced with any standard C or CS-mount lens commonly used within the surveillance industry.

Follow the instructions below to replace the supplied lens with any C or CS-mount lens.

1. Unscrew the Internet Camera lens
2. When using a C-mount lens, attach the new lens to a CS to C-mount adapter.
3. Screw the new lens onto the Internet Camera.
4. Refer to **Adjusting the Internet Camera Focus** on the previous page.
5. Refresh the Web browser and monitor the results from the Internet Camera.

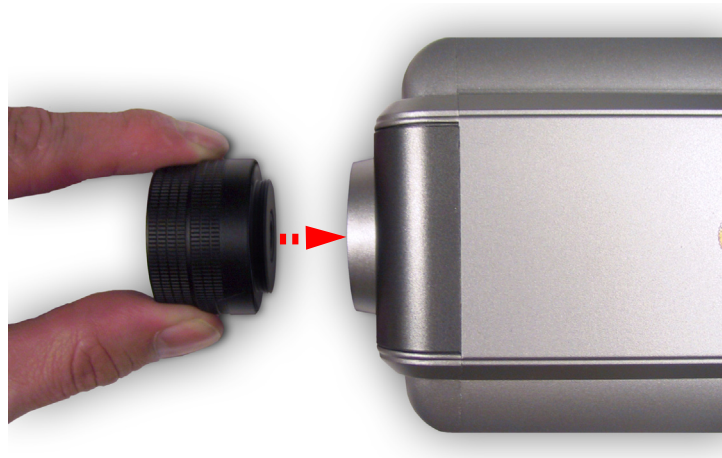

WARNING: Direct exposure to sunlight may cause permanent damage to the CCD sensor. Therefore do not expose the Internet Camera's lens directly to sunlight. When operation is required in glaring light environment, it is recommended to use an iris lens. The Internet Camera is designed for indoor usage and if your application requires prolonged exposure to sunlight, a sun visor is recommended to protect the Internet Camera.

Reset and Restore

There is a button hidden in the pinhole beside the power socket. It is used to **reset** the system or **restore** the factory default settings. Sometimes resetting the DCS-3420 will return the system back to a normal state. If the system still has problems after reset, restore the factory settings and install again:

- RESET:**
1. Lightly insert a paper clip (or a similar sized tool) into the reset hole on the back of the camera, press lightly and then release the button.
 2. The LED on the back of the camera will begin blinking red and green fast.
 3. When the LED stops the blinking fast and starts blinking once every second, the reset is completed.

- RESTORE:**
1. Insert the paper clip, or another similar tool, and press and continuously hold down the button recessed inside the reset hole.
 2. Wait for the LED on the back of the camera to blink red and green and hold the button through two cycles of blinking (about 5-7 seconds.)
 3. Withdraw the tool after the second cycle of the LED blinking and a factory restore has been completed.

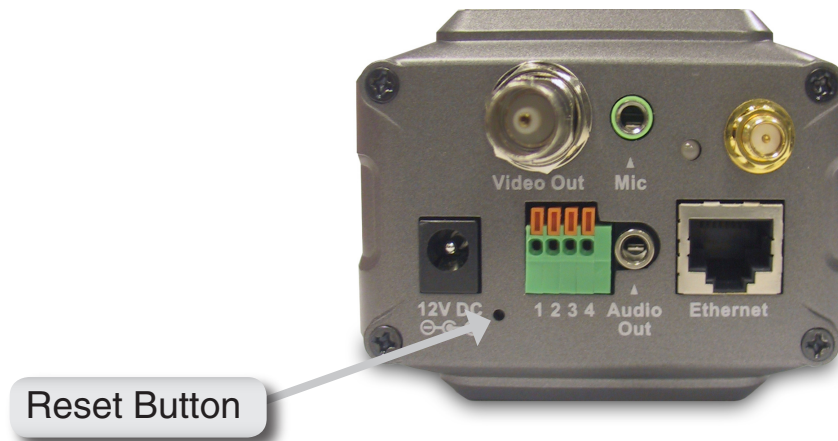

Note: Restoring the factory defaults will result in the loss of any previous settings and will require running the IP Installer to find the camera's IP address.

Installing the IP Surveillance Software

The IP surveillance software on the CD included with the DCS-3420 Internet Camera converts the DCS-3420 into a powerful, yet flexible, surveillance system for home or business, with these features:

- Real-time Monitoring
- Video Recording to hard disk
- High quality video
- High video compression ratio
- Maximum of 16 cameras with different display layouts
- Smart playback
- Triggered event browsing
- Fast database searching
- Configurative automated alarms
- Account password protection
- Scheduled recording for each camera
- Email / FTP video snapshots
- AVI file export
- Motion detection for each camera

To install IP surveillance, click on the **IP surveillance** link on the CD included with the Internet Camera.

Click **IP surveillance**



The Welcome screen appears.

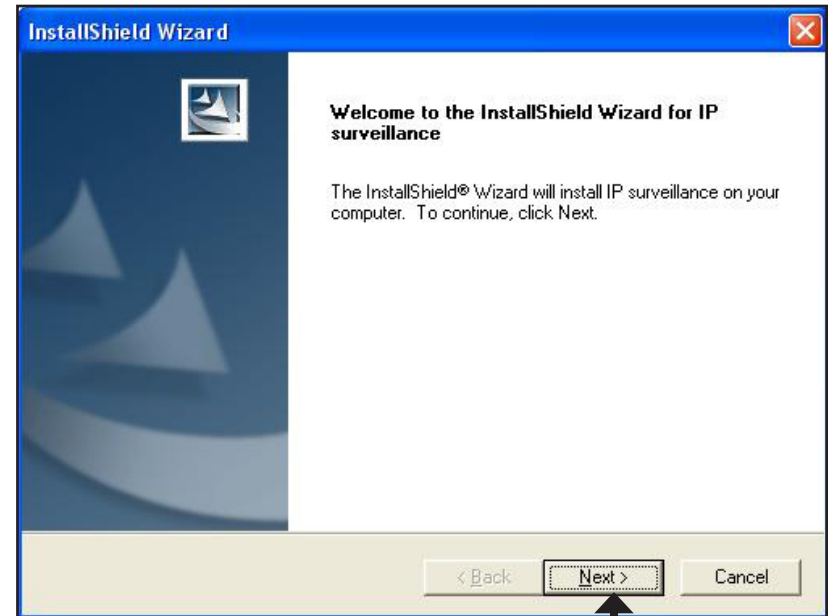

Click **Next**

Please read the Software Licensing Agreement and click Yes if you wish to accept the agreement. Click No to exit the installation.



Click **Yes**

Enter your User Name and Company Name information.

Note: This User Name is not the User Name to log into the IP surveillance program.

The screenshot shows the 'InstallShield Wizard' window with the 'Customer Information' tab selected. The window title is 'InstallShield Wizard'. Below the title bar, it says 'Customer Information' and 'Please enter your information.' There are two text input fields: 'User Name:' containing 'D-Link Camera' and 'Company Name:' containing 'D-Link'. Below these fields, it says 'Install this application for:' followed by two radio button options: 'Anyone who uses this computer (all users)' (which is selected) and 'Only for me (D-Link Camera)'. At the bottom right, there are three buttons: '< Back', 'Next >', and 'Cancel'. The 'Next >' button is highlighted with a mouse cursor.

Click Next

You must setup the administrator's password in order to proceed. Input and confirm your password in the window shown below.

The screenshot shows the 'InstallShield Wizard' window with the 'Administrator Password Setup' tab selected. The window title is 'InstallShield Wizard'. Below the title bar, it says 'Administrator Password Setup'. The main text reads: 'You must set admin password before you could use this program. Please type the password in the following.' There are two text input fields: 'Password:' and 'Confirm:'. At the bottom right, there are three buttons: '< Back', 'Next >', and 'Cancel'. The 'Next >' button is highlighted with a mouse cursor.

Click Next

Select the installation directory for the IP surveillance software. You can change the installation directory by clicking Browse.

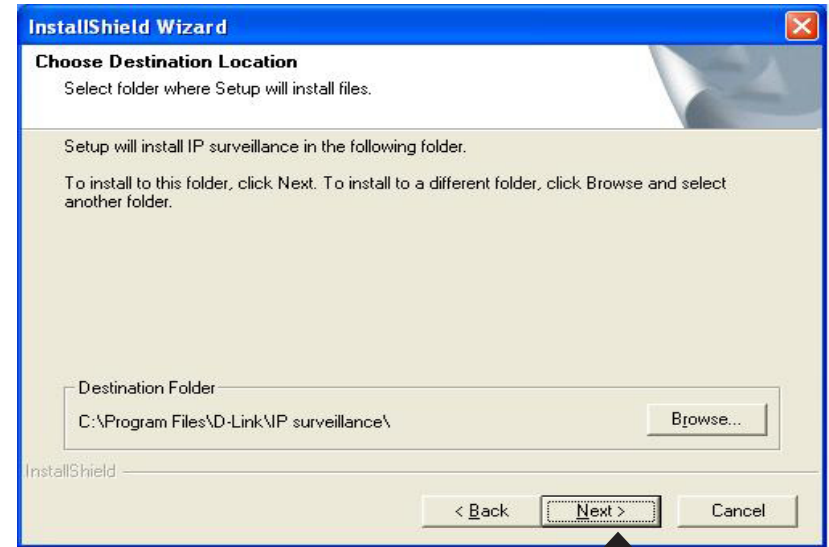

Click Next

Select the program folder to install the application software.

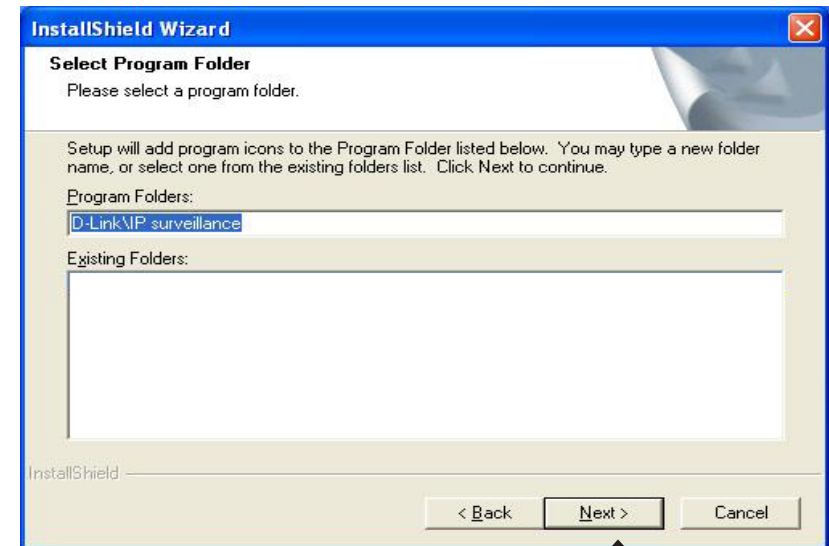

Click Next

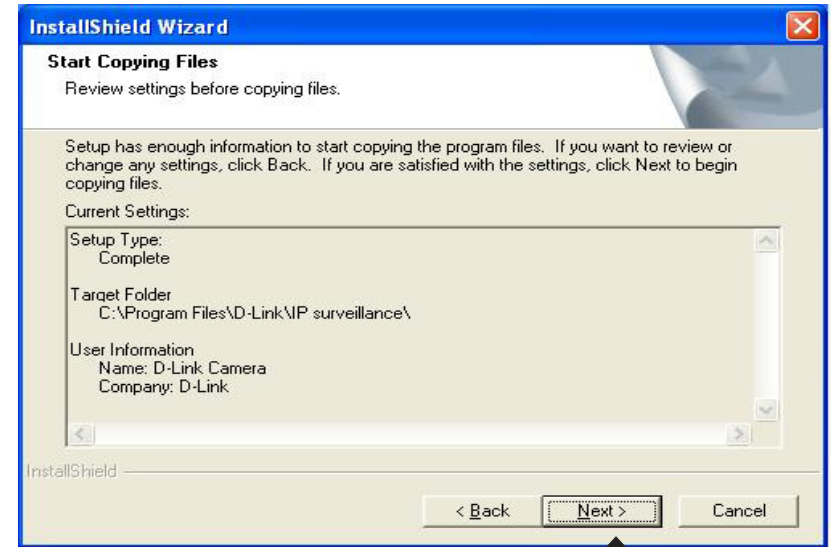

Click **Next**

The installation is complete.

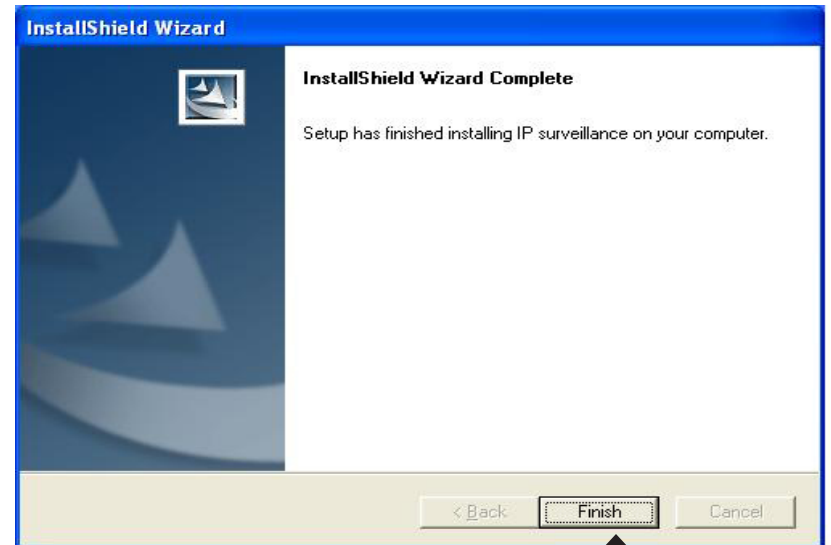

Click **Finish**

Using the IP Surveillance Software

Before you begin installing this application software, the hardware system requirements must be checked first. The minimum system requirements recommended for this application are as follows:

- Browser: Internet Explorer 6.x or above
- CPU: Pentium 4 1.7GHz or above (Pentium 4 2.8GHz or above with 512MB memory and a 32MB video card is required for multiple camera viewing and recording in IP Surveillance)
- SDRAM: 256MB SDRAM
- Hard Disk: 40GB
- Video Card: Video Card with 32MB Display memory.

Launcher

Launcher is a controller program that allows users to invoke Monitor or Playback quickly.

System Tray Icon

The Launcher icon reflects current state of IP surveillance. The  icon in the system tray signifies that the IP surveillance Software is currently active on the system.

Security for Launcher

When Launcher starts, there is no need to undergo a username/password check. But when users want to click on the icon of Launcher on system tray, Launcher will pop up a username/password dialog the first time for menu popup or when Launcher is locked. If a user fails to pass the authentication check, no menu will show up. If a user fails 3 consecutive tries he/she will be locked out for a period of 60 seconds.

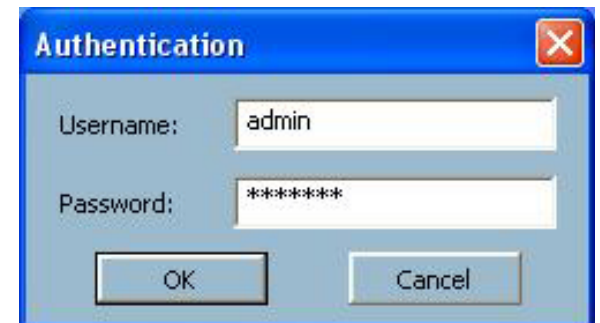

After passing authentication, users will be able to use all functions. If users want to leave the computer, it is possible to lock the Launcher for security reason. When Launcher is locked, the user will need to pass authentication again to see the popup menu.

Note: For initial setup, the default Username is “admin”. The password is the password provided during installation.

When Launcher is locked, the unlock window will appear, prompting for the user password in order to unlock.



The input area of the dialog will be grayed (disabled) for 60 seconds after 3 consecutive failures.

User Interface

Below is the user interface for Launcher:

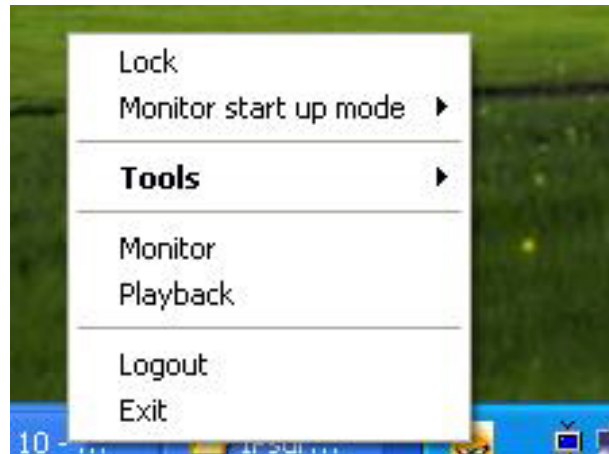

The main user interface for Launcher is an icon on system tray, and the popup menu appears when the user clicks on the icon. The menu items are listed below:

Lock: When this item is selected, Launcher will enter lock mode. In lock mode, whenever users want to invoke the menu, a dialog asking for ID and password will appear. The interface for this dialog is covered in previous the section.

Monitor start up mode: Users can select whether or not to autorun Launcher when Window boots up.

Tools: The Change local admin's password dialog looks like this:



The User Management utility looks like this:



- Monitor:** Starts up the Monitor program. If the Monitor program is already running, clicking this button will re-open the Monitor window.
- Playback:** Starts up the Playback program. If the Playback program is already running, clicking this button will re-open the Playback window.
- Logout:** Logs out user from IP surveillance. After logging out, if the user wants to return to the menu, and clicks the Launcher icon, the authentication box will appear prompting for username and password again.
- Exit:** Exits Launcher. If users choose this option, Launcher will show a message box prompting to confirm if users really want to exit, and warn users that exiting Launcher will also close Monitor and Playback.

Monitor Program

Features of the Monitor Program

Traditional Surveillance Features:

- Real-time monitoring
- Recording

Special Features:

The digital surveillance system supports not only the features listed above, but also the following features, which make the system more powerful and convenient.

- Simultaneous real-time monitoring and recording audio and video
- High quality video up to full screen display
- High compression ratio
- Maximum of 16 cameras with different monitor layouts
- Auto alarm in multiple modes
- Account-password protection
- Multiple recording modes: Event-driven, Scheduled, and manual recording for each camera.
- Just-in-time snapshot
- Motion detection with 3 alert windows for each camera

Application Layout and Functionalities

This section demonstrates a global view of the monitor program, shown below. The components of the monitor tool will be introduced in detail in the following sections.

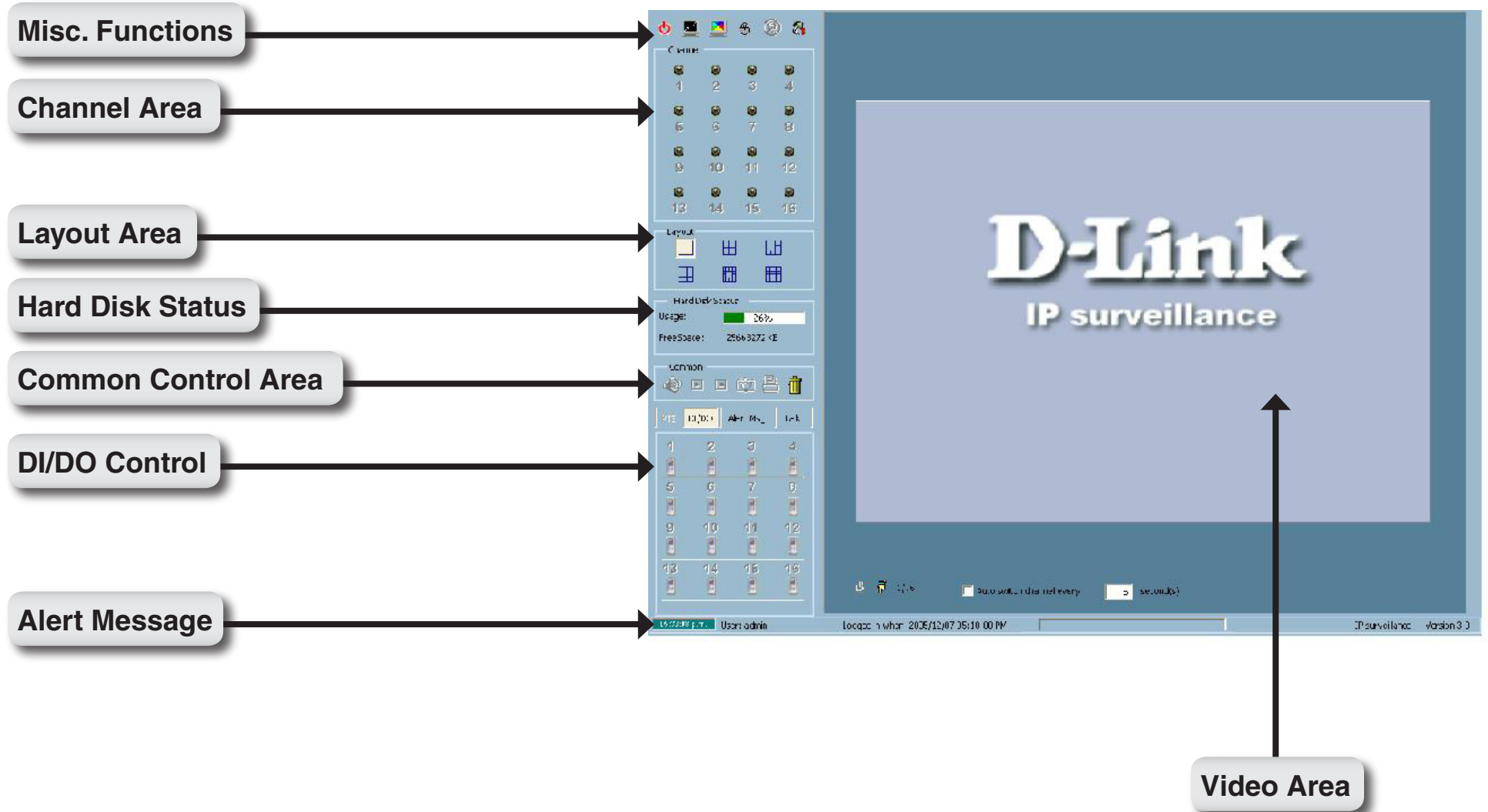

There are several parts in the monitor tool:

Misc. Functions: These include application exit, minimization, full screen monitoring, lock, stop alert, and configuration menu for camera configurations, global settings, scheduler settings and the user information of this application software. Tips for these operations are provided when you move the mouse cursor over each icon.

Channel area: This area displays the status of each video channel. The information indicates the status of connection, recording, selection, and alert-event trigger.

Video area: In this area, you can see the video of the selected channel in the display frame. The number of the display frames in the video area depends on the layout chosen by the user. You can also use convenient controls to alter the video display.

Layout area: You can change the monitoring layout in this area. There are six kinds of layouts: 1, 4, 6, 9, 13, or 16 video display windows in the video area.

Hard disk status: In this area, you can get the status of the hard disk in which the video database resides. The status reminds you to arrange the available storage size of the recorded video database.

Common control area: This area includes volume control, manual recording, video printing, snapshot, and trash can to remove video from display windows.

DI/DO control: This tool receives the digital input signal and sends digital output signal to the remote Video Server/ Network Camera series product associated with the dedicated video channel.

Alert Message: This tool will display the latest alert messages received by the remote Video Server / Network Camera series product associated with the selected video channel.

Logging In

You need to login the first time when you start the Launcher. The authentication window is shown below. If you do not have an account, the monitor tool will not execute. You must log in as admin (administrator) to use this application. Enter the password for the administrator.

Note: *The password is the one you provided during installation.*



The Admin Privilege

In the Monitor program, the admin has the right to access the DCS-3420 Network Camera through this application software and change the local settings as well. But the admin password for the software is not the same as the admin password for the Internet camera. You can change the settings of each selected Internet camera from the Monitor program only if you have the admin password for the Internet camera.

If you have the admin privilege, you have the right to do the following tasks:

- Run the configuration tool
- Change the recording schedule
- Change the local settings

Again, if you need to change the settings of the DCS-3420, you must have the administrator's password for the camera itself.

Camera Configurations

When you log in for the first time, you should configure this application software to connect the DCS-3420 in “Configuration Menu > Camera Configurations”, shown in the figure below. You will need the admin (administrator) password of the camera in order to run the configuration.

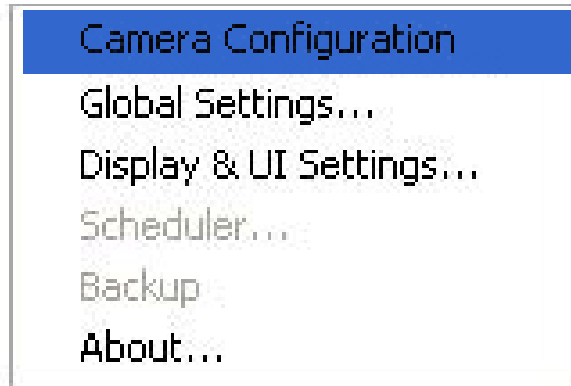

Once you click “Configuration Menu > Camera Configurations” for setting each camera, all recording processes will be stopped indicated by a warning window popped up in advance to keep you informed.

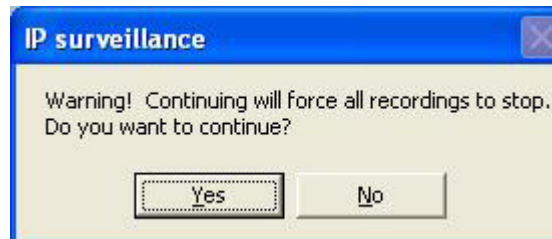

The Layout of the Configuration

This section discusses the local settings for the connection and the functional configuration of each camera. If you are interested in the remote settings for each camera, you can refer to “Using the DCS-3420 with an Internet Browser” (page 30).

Load Settings

Alert Settings

Recording Settings

Save

In the local settings, shown below, three main functionalities are provided:

- Insert:** Click to insert a new camera to the list.
- Delete:** Click to delete a camera from the list.
- History:** Click to view the history of all cameras in the list.

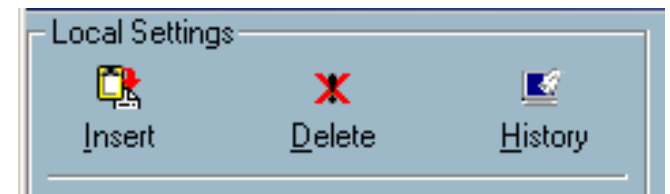

Insert

To insert a remote network camera to the camera list. Click the Insert button, an “Insert New Channel” dialog will popup, as shown here. Specify the IP address, port, and admin password of the network camera, click the **OK** button to close the dialog. Then the system will try to connect to the selected camera. If the connection succeeds, the camera will be inserted to the camera selection list.



Once the camera is added, you will see the IP address of the camera and also the port that is opened on the camera (port 80 in this example). The selected camera has been added to the selection list.

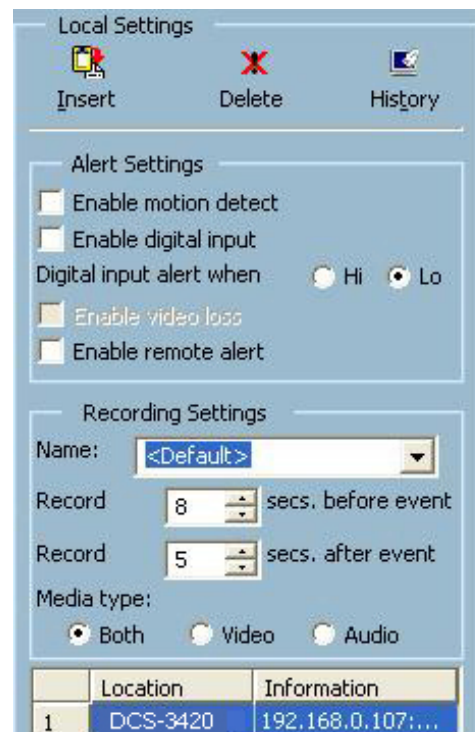

Delete

Highlight the camera that you want to delete from the list and click on the Delete button. The selected camera will be deleted. It removes the selected network camera from the camera list.

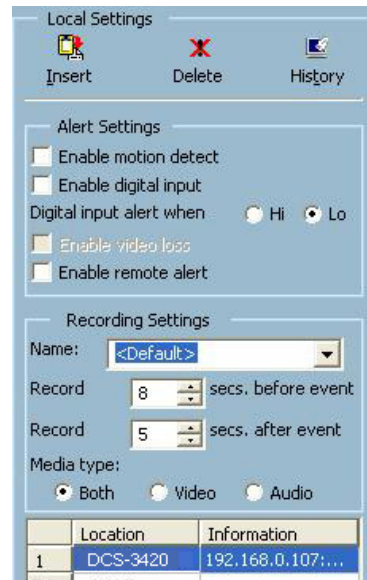

History

Clicking the History button will popup a historical camera list, which lists the latest 16 cameras you have inserted into the camera list. Clicking on one camera in the history list will insert the camera into the camera list. The history list is shown here.

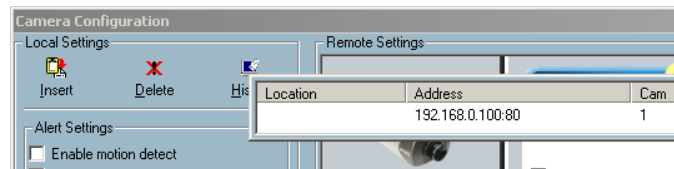

Alert and Recording Settings

Alert Settings

- Enable motion detect
- Enable digital input
- Digital input alert when: Hi Lo
- Enable video loss
- Enable remote alert

Recording Settings

Name:

Record: secs. before event

Record: secs. after event

Media type: Both Video Audio

Alert Settings

Specific alert actions can be performed by setting the options in this window.

- Enable motion detect:** This will trigger an alert sound that has been specified in the section titled “Display & UI Settings\Local Alert Settings”. Check this option to enable audio alerts for the selected camera.
- Enable digital input:** This function is similar to “Enable Motion Detect” mentioned above. Once this option has been checked, a digital input device will be able to trigger an alert sound and recording.
- Digital input alert:** This application software provides options for you to define the triggering criteria for the digital input of the camera. The alert of the digital input can be defined as high-level triggered or low-level triggered.

Recording Settings

Record # secs before event: Once the automatic video recording has been activated, you can change this setting to regulate the recording of triggered events. Recording will start from the specified number of seconds before the alert event has been invoked.

Record # secs after event: Recording will last for the specified number of seconds after the alert event has been invoked.

Media Type: You can specify which media type you want to record: Video, Audio, or both.

Changing the Camera Order in the List

You can “drag and drop” in the grid area of the camera list to change the sequence of the connected Network Cameras, which is shown below. This will allow you to rearrange the cameras in an order of your choice. Once the camera is moved to a specified location, the proceeding cameras will then move 1 position up or 1 position down depending on which direction the selected camera was moved.

Press and hold the left mouse button at the gray index field of the camera you would like to move.

| | Location | Information |
|----|------------|------------------|
| 1 | Front Door | 192.168.0.100:80 |
| 2 | --NONE-- | |
| 3 | --NONE-- | |
| 4 | --NONE-- | |
| 5 | --NONE-- | |
| 6 | --NONE-- | |
| 7 | --NONE-- | |
| 8 | --NONE-- | |
| 9 | --NONE-- | |
| 10 | --NONE-- | |
| 11 | --NONE-- | |
| 12 | --NONE-- | |
| 13 | --NONE-- | |
| 14 | --NONE-- | |
| 15 | --NONE-- | |
| 16 | --NONE-- | |

Drag the mouse to your new selected location and release the mouse button. Then Video 1 will be moved (to the 12th row in this example).

| | Location | Information |
|----|-----------------------|----------------|
| 1 | --NONE-- | |
| 2 | --NONE-- | |
| 3 | --NONE-- | |
| 4 | --NONE-- | |
| 5 | --NONE-- | |
| 6 | --NONE-- | |
| 7 | --NONE-- | |
| 8 | --NONE-- | |
| 9 | --NONE-- | |
| 10 | --NONE-- | |
| 11 | --NONE-- | |
| 12 | Moving channel 12 ... | 2.168.0.100:80 |
| 13 | | |
| 14 | --NONE-- | |
| 15 | --NONE-- | |
| 16 | --NONE-- | |

Once you click the Save button in the left-bottom corner of this window, the changes for all camera configurations will be saved and will be applied immediately to the IP surveillance.

Global Settings

After completing the connection to each remote Network Camera, we need to configure the global settings for all the cameras. These include the video database directory, the usage of the Hard disk, and options for video display.

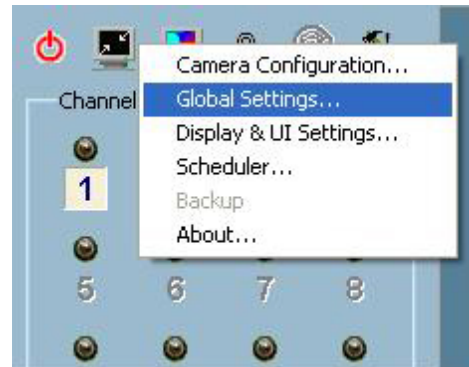

You can activate the global settings window from “Configuration Menu > Global Settings...” shown above.

All recording processes will be stopped when activating the global settings window, indicated by a warning window popped up in advance to keep you informed.

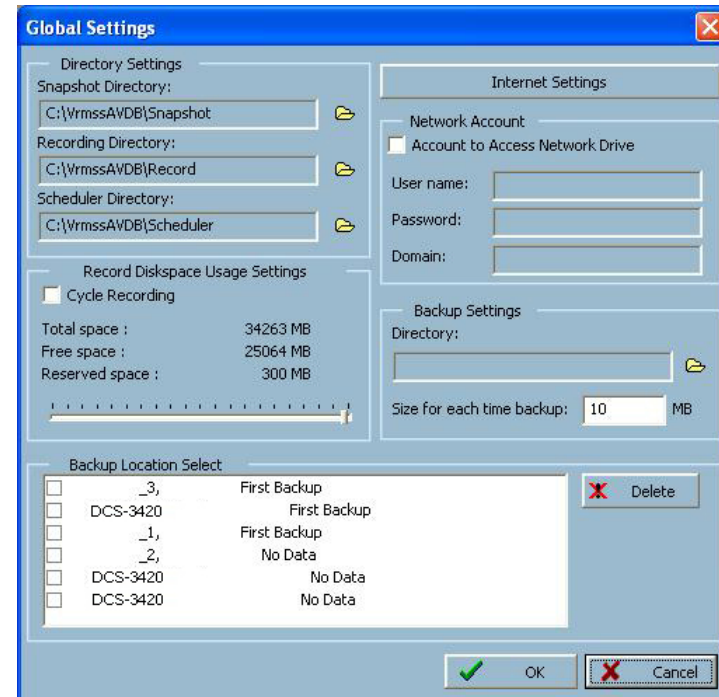
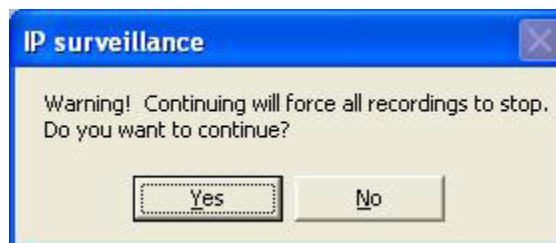

Directory Settings

- Snapshot directory:** The directory for storing snapshots in *.bmp format from video channels of the monitor tool and playback programs.
- Recording directory:** The directory for storing the recorded video data from video channels.
- Scheduler directory:** The directory for storing the default and user-customized schedules for the scheduled recording of each channel.

Record Diskspace Usage Settings

- Cycle Recording:** When you turn this setting on, the video database system of this application will overwrite the oldest data if the specified path has become full. That means it will record video data in a loop. If this setting is unchecked, all recording will stop when the limit of the hard disk usage is reached.
- Reserved space:** Indicate the size of the hard disk that will be reserved for other Windows® applications (at least 300MB). The remainder of the hard disk space will be available for recording. The more space you have reserved, the less there will be available for your camera(s) to record to. As you move the bar to the right, more space will be available for your camera(s) and conversely, less space will be available for your other applications. If the recording data exceeds this limitation, the new video data will replace the oldest data (on a First In First Out (FIFO) basis) when “Cycle Recording” has been checked.

Display & UI Settings

Alert Sound: You can load a custom *.wav file for the alert triggering sound, or you can select a sound file from the Windows® sound file directory.

Modulation Mode: You must select the input signal format (NTSC or PAL) for displaying the original resolution of video stream from DCS-3420.

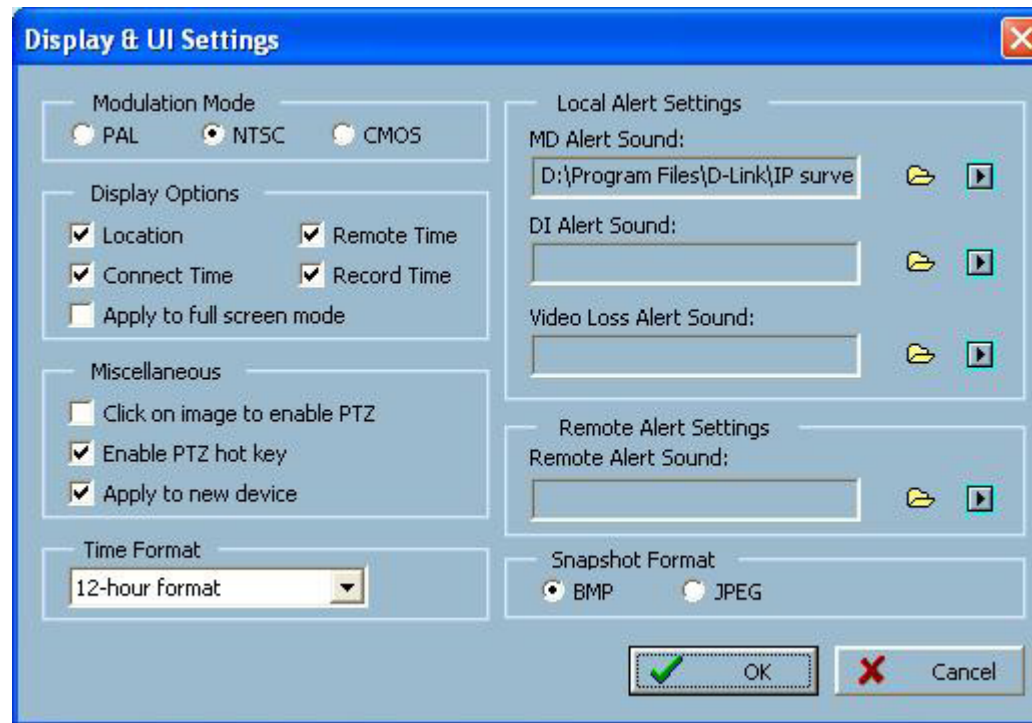
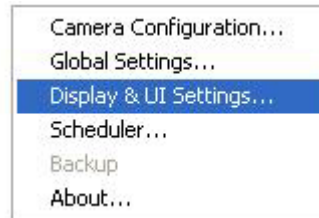

Display Options

In the video displaying frame of each channel, there are two status bars. The upper bar contains “Location” (channel number + camera name) and “Remote Time.” The lower bar contains “Connection Time” (Day:Hour:Min) and “Recording time” (Day: Hour:Min). All of them, shown in the figure below, can be enabled or disabled here individually for the status indication. Apply to full screen mode can also be turned on here. Once it has been checked, the status bar in each channel showing date, location, connection, and recording time will be shown in both display frame mode and full screen mode.



Using the Scheduler

This section discusses the method of how to use the scheduler.

The scheduler allows the user to schedule recordings from the selected video channel of the DCS-3420. Through both the graphic user interface and time period selection options, you will be able to easily regulate a schedule for each video channel.

The main features of the scheduling tool are:

- Friendly graphic user interface for schedule editing
- Flexible schedule scheme suitable for all applications
- Individual schedule for each video channel
- Automatic recording

Start the Scheduler

The scheduler will not be accessible until at least one camera has been added to the camera list. Go to the configuration menu and click on Scheduler to launch the Scheduler.

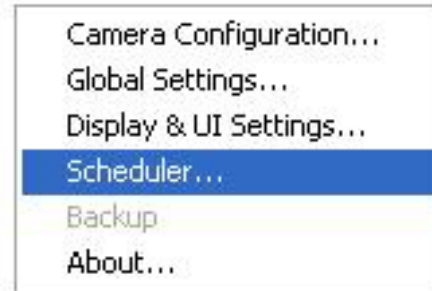

The Layout and Functionalities Introduction

The layout of the scheduler and its components, shown below, will be described. The layout of the scheduler is roughly divided into 4 parts: Video Channel Selection Area, Primary schedule settings, Secondary schedule settings, and Operation Buttons.

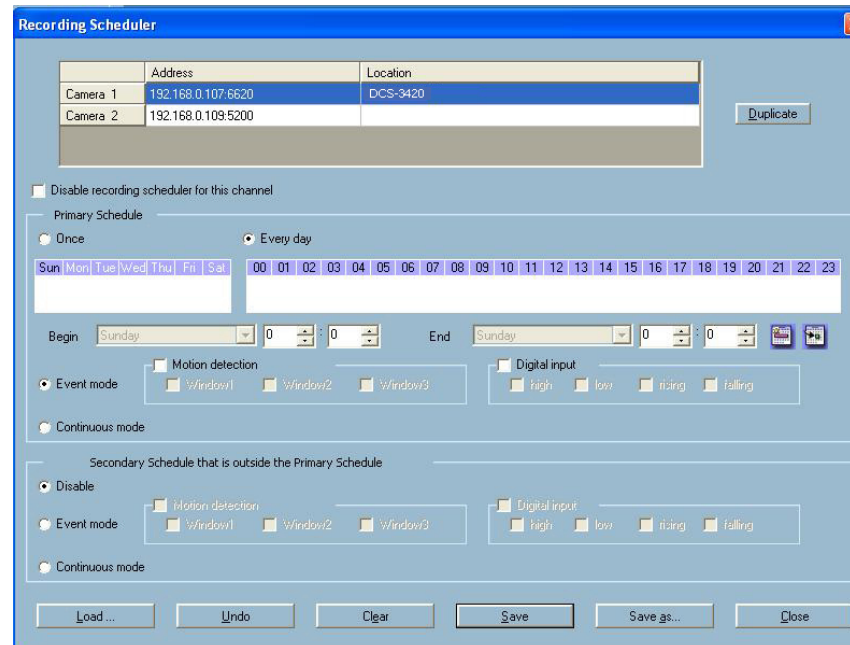

Video Channel Selection Area: The video channel selection area provides the IP addresses and location information of the connected video channels for the user's reference. You can select a video channel in this area and create a schedule for it.

Primary Schedule: The Primary schedule consists of the day time-line, week time-line, begin time selector, end time selector, and event mode settings.

Secondary Schedule: The Secondary schedule consists of event mode settings.

Operation Buttons: The operation buttons allow the user to manipulate the edited schedule of the selected video channel. The scheduler can be closed from here.

The Functionalities of Configuration Components

The four main parts of the scheduler have been briefly described above. The four parts will be described in detail in the following section.

Video Channel Selection Area

In this area you will select the video channel that you want to set a schedule for. Each video channel will display a name, an IP address, and the location. Please note that when you switch between video channels in this area, the changes in the schedule of the previous video channel will be saved automatically.



| | Address | Location |
|----------|--------------------|----------|
| Camera 1 | 192.168.0.107:6620 | DCS-3420 |
| Camera 2 | 192.168.0.109:5200 | |

Primary Schedule

Schedule with Time Lines

There are two different time-lines: hour time-line and week time-line. You can make your own schedule by plotting markers in all time-lines. These two time lines are associated with each other. That is, if you make changes in one time-line, the corresponding changes will be applied with scale to the other three time-lines in the same schedule. Before you begin, make sure that you select “Once” if you want to choose the days to record on.

Week Time-Line

In the figure below, Week time-line is displayed. It includes the time-line, schedule information, and the selected day in the week.

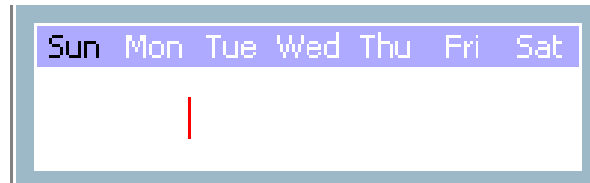

Marking/Unmarking the Recording Time on the Week Time-Line

The corresponding changes for the markers on the week time-line will be automatically added to the hour time-lines, which is shown above. You can also mark and unmark the plotted bar by clicking and dragging with the left and the right mouse button.

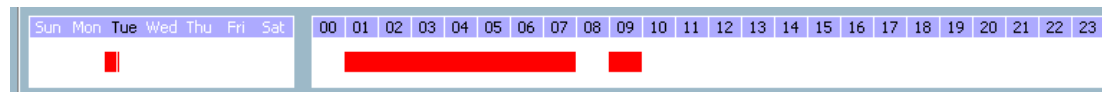

Hour Time-Line

In the figure below, the Hour time-line is displayed.

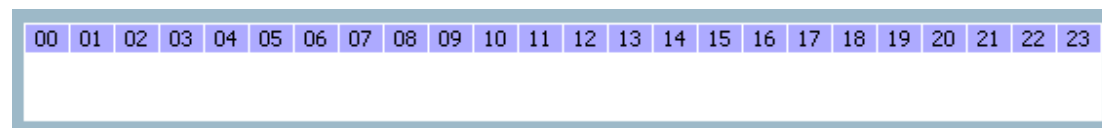

Marking/Unmarking the Recording Time on the Hour Time-Line

You can apply the one-click function by clicking the left mouse button and dragging to mark the time on this time-line. The operating method for the hour time-line is the same as that of the week time-lines. Please refer to the previous section about marking/unmarking on the week time-line for more details.

Schedule with Time Picker

Begin and End Time

There are three controlling units in both “Begin Time” and “End Time” selectors shown below. The first unit of these two selectors is the date picker. You can select day with it to set the beginning time and the ending time for the recording interval.

The second and third units are the hour picker and the minute picker. You can change the hour and minute settings for the beginning and ending time with them.

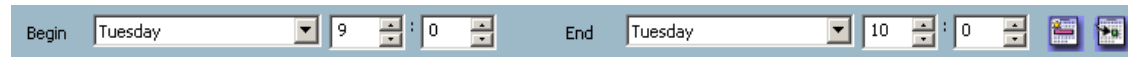

Note: The time set in “Begin time” must be earlier than that in “End time”. Otherwise the settings will not be applied.

Apply and Erase Buttons

After you have selected the time period with “Begin time” and “End time” picker, you can apply the period picker, shown in the figure below, to set the periodical types of the time interval set previously. After the settings in “Begin Time”, “End Time” and “Period Picker” are all done, you should click the “Apply” button or “Erase” button on the right to add or clear this scheduling information to the editing schedule scheme. Note that only after you click on the “Apply” button, the scheduling information settings will be written back into the whole editing schedule scheme. That means this edited scheduling time interval is valid only after you “Apply” the changes.



Schedule in Event Mode

You can select to record in Event mode or Continuous mode by the Schedule mode selector as shown in the figure below. There are two types of event recording. Please refer to the following two sections for more information.

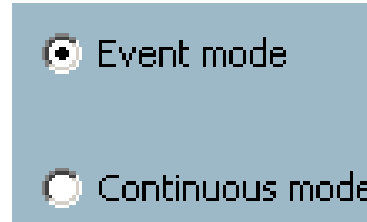

Motion Detection

As shown below, you can check the windows that you would like to record while the motion detection is triggered.



Digital Input

In the figure below, there are four conditions for the digital input. Check the condition that you would like to record while the condition triggers.

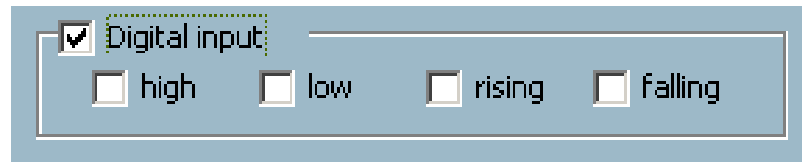

High: Checking this will trigger recording while the digital input is high. The technical name for this event is line trigger.

Low: Checking this will trigger recording while the digital input is low. The technical name for this event is line trigger.

Rising: Checking this will trigger recording while the digital input is changing from low to high. The technical name for this event is edge trigger.

Falling: Checking this will trigger recording while the digital input is changing from high to low. The technical name for this event is edge trigger.

Schedule in Continuous mode

If you select Continuous mode in the schedule mode selector, it will record continuously during the schedule that is set up by the user.

Secondary Schedule

Secondary schedule is for recording outside of the primary schedule. The secondary schedule provides options to record without a specified date or time.

Schedule modes

There are three modes in the secondary schedule: Disable, Event mode, and Continuous mode. If event mode is selected in the secondary schedule, the camera will record whenever an event is triggered. If continuous mode is selected, the camera will begin recording continuously after scheduling settings are saved. These two modes are the same as the primary schedule. Please refer to the previous section for more detail.

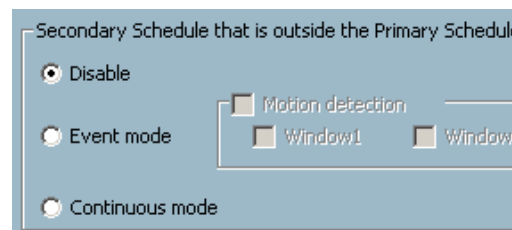

Operation Buttons

There are six operation buttons that allow you to handle the schedule schemes: “Load...”, “Undo”, “Clear”, “Save”, “Save as...” and “Close.” These operation buttons are shown in the figure below.



Load: This button allows you to load pre-edited schedules from the scheduling directory for the selected video channel. Note that you should save the schedule you are currently working on before loading a new one. Otherwise, the current changes will be lost.

Undo: Click on this button to undo all changes for the current schedule since the last save.

Clear: This button will clear all changes in the current schedule of the selected video channel.

Save: This button is used for saving changes to the current schedule.

Save As...: This button is used to save the current schedule as another file name instead of the default name.

Close: Click on this button to close the scheduler.

Backup Settings

Using Backup Settings in the global settings window, you can backup recorded data from selected cameras to a specified location.

Directory: This is the directory where backup data will be saved. You can select the location by clicking on the folder icon.

Size: You can set the size limit of the data that will be backed up. The default size limit is 10MB. The maximum value for this setting depends on the amount of Free Space available on your hard drive. This value can be found under the “Record Disk space Usage Settings” section of the global settings window.

Backup Location Select: Select the locations to backup by clicking the checkbox next to the location/camera name. To delete a location, select the location and click the “Delete” button to the right of the Backup Location Select window.

After you have set your backup settings in the global settings window, you can backup recorded data by clicking “Backup” in the Configuration Menu, as seen below:

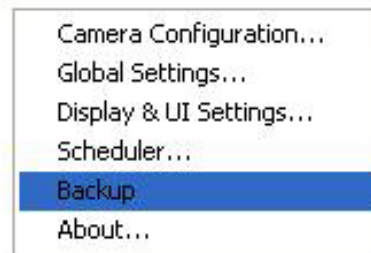

Using the Monitor Program

This section depicts, in detail, how to manipulate the monitor tool.

Connection of the DCS-3420

Once you have the privilege to connect to the DCS-3420, the cameras will automatically appear in the video area in the order they are connected. Once you have set up the camera in the video channel, the color of the channel number will turn green, indicating that the camera has been added to IP surveillance. If you do not set up the camera for the video channel, the color of the channel number will be gray.

There is a unique light signal associated with each channel number. It indicates the status of the dedicated video channel, which is depicted as follows:

Off: The video channel is not connected with any DCS-3420 yet.

Green: The green light means the DCS-3420 associated with this channel number is connected, and the video is monitored in the video area.

Red: The red light indicates the video from this channel is recording into the video database. In this mode, you don't have to drag and drop the channel to the video area. This means that this application software supports real-time recording with and without real-time monitoring for the dedicated video channel.

Blink: With the motion detection mechanism set in the DCS-3420, the light of the corresponding channel will blink once the motion event is triggered.

If you do not want to monitor one video, you can drag and drop the video (in the video area) to the trash can in the common control area of the monitor program. The following section will demonstrate the procedures for “drag and drop” step-by-step.

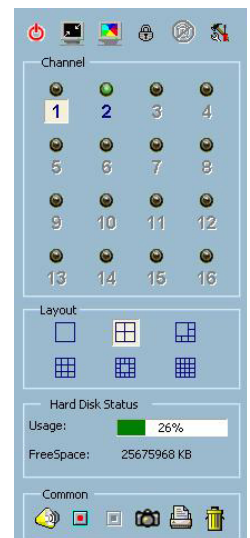

Show the video of a specified channel

This section depicts the method of how to show the video of a specific channel in a display window.

Step 1: Move the mouse cursor to the camera you would like display in the window.

Step 2: Press and hold the left mouse button, and then drag it to a display window in the video area on the right side of the screen. Note that the cursor will change according to the area in order to indicate whether the area is droppable or not.

Step 3: Release the left mouse button while on top of a display window. The video will appear in the display window as shown below. In each display layout, only one window can be assigned to a camera. Also, each camera must have its own separate window when displayed. Once the video is in a display window, it can be dragged and dropped to other windows. If you drag one camera's video to a window that already has its own camera's video, the two cameras will trade display windows. Dragging and dropping is a very convenient way to manipulate the video channels in the IP surveillance Software.



Removing video from a display window

Step 1: Move the mouse cursor to the display window that contains the video channel you wish to remove.

Step 2: Note that the cursor will change to the hand-shape when it has been moved onto the displaying frame. After that, press the left mouse button and hold it.

Step 3: Move the cursor, while still holding the left mouse button, to the trash can in the common area of the monitor program.

Step 4: When the cursor shape changes to an arrow-shape over the trash can, release the left mouse button. The video in the corresponding display window will disappear. All operations above are shown in the figure on the following

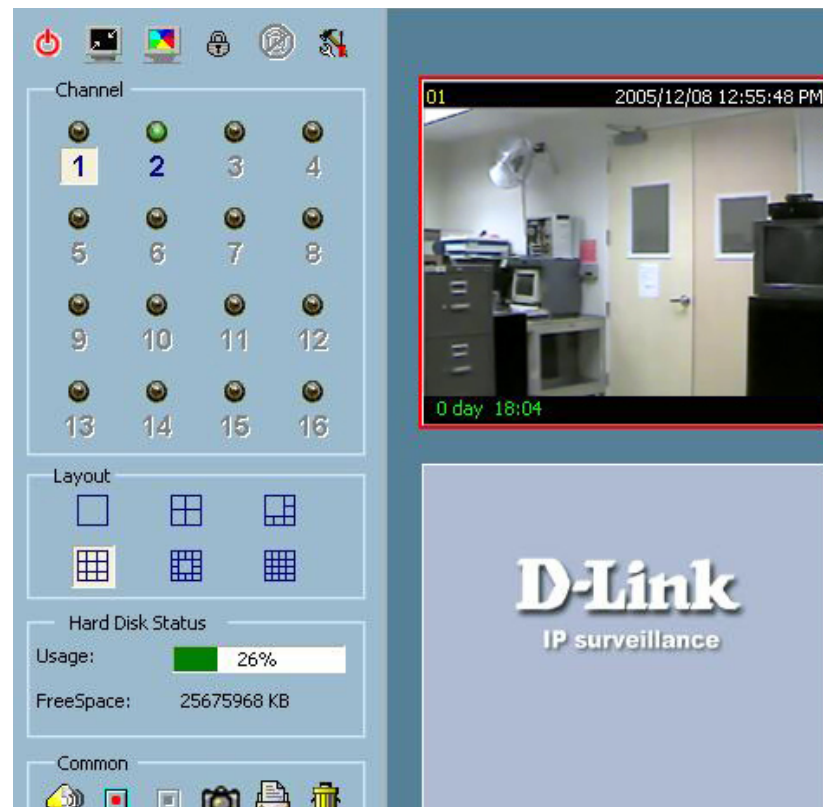

The Layout

There are six different layouts available, as shown below, for the display windows in the monitor program. You can select between 1 camera, 4 camera, 6 camera, 9 camera, 13 camera, and 16 camera layout. You can select one of them by clicking on a layout icon. In each layout, you can drag and drop the “channel number” to any display window in the video area. Following the procedures described in the section titled “Show the video of a specified channel”, you can add the video channels to display windows within the selected layout in the video area one by one. You can also exchange the video between different display windows by dragging and dropping. Double clicking on a display window will switch to single channel layout.

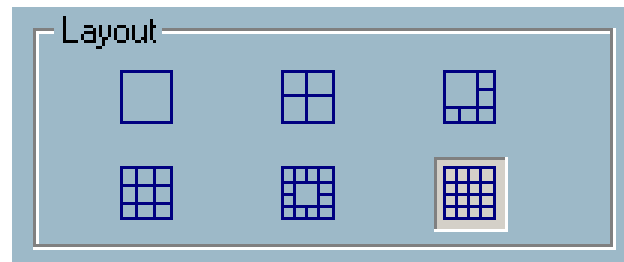

When you choose the one-channel layout or four-channel layout, the “Page up” and “Page down” buttons will be shown in the left-bottom corner of the video area. You can use these two buttons to switch the pages, as shown in the figure below.

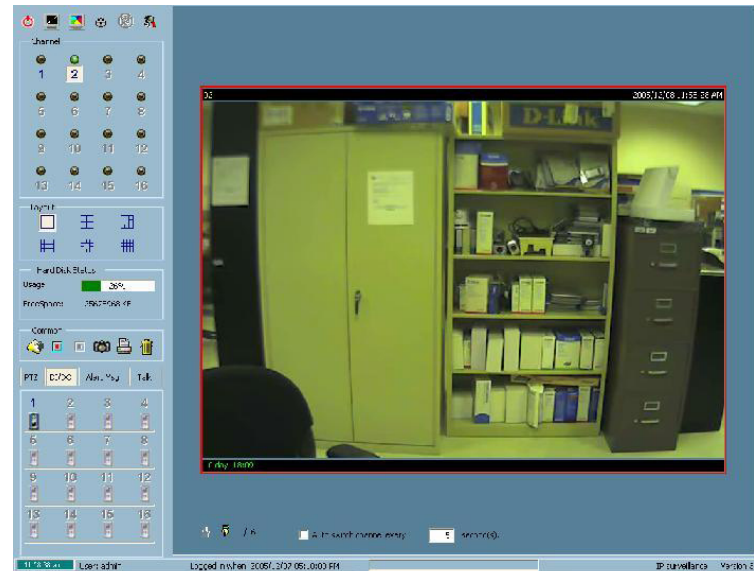

To view an individual camera from the multi-camera layout, double-click on the desired display window. You will see that the size of the display window is the same as the one-channel layout. Clicking the Back button in the upper-left corner of the video area will switch to the previous selected multi-camera layout.

The position that each video channel is in for every layout will be saved for the next time the layout is selected.

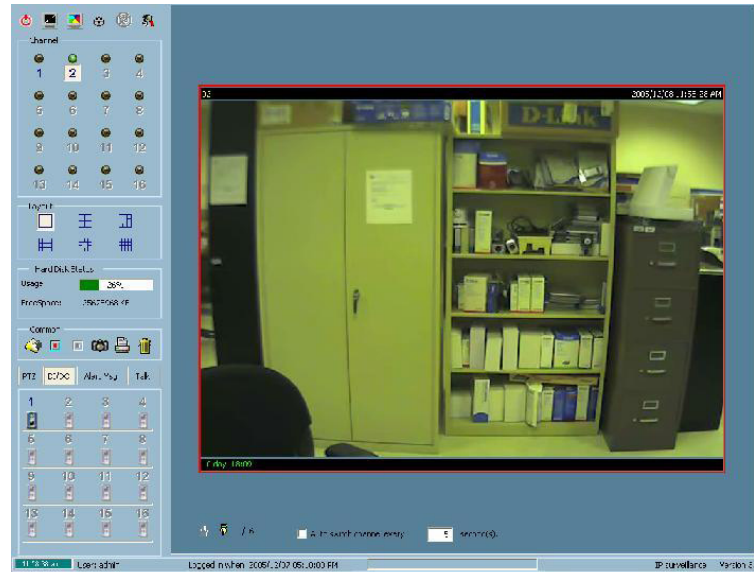

Input/Output Control Tools

IP surveillance includes DI/DO control (Digital Input / Digital Output) control and an alert message receiver. Each of these are described in detail on the following pages.

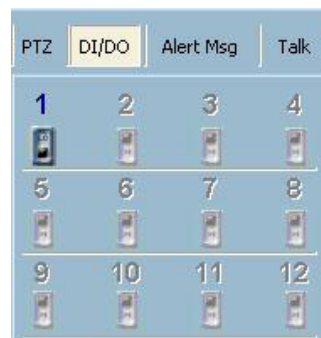

Clicking on the “DI/DO” button shown below, you can switch to the DI/DO controls. The color of the channel number indicates the status of the camera’s DI (Digital Input). You can click the “Switch button” to change the HI/LOW state of the DO (Digital Output). With these features, you can monitor the remote sensor input from DI and also trigger the camera by DO switch.



When the color of a DI/DO channel number is gray, that means the video channel has not yet been connected to a camera.

Alert Message

If you have checked the box “Enable Motion Detect” or “Enable Digital Input” on the Camera Configurations > Alert Settings screen, the alert message will show in the window shown above. Once the alert, caused by motion detection or a digital input level change is triggered, the alert message will be shown in this window. If there are more events than this window can display, a scroll bar will appear.

The message format is described as follows:

“time”=>”alert type” #”channel number”(“win1”,“win2”,“win3”)

For example, the message “PM 02:41:00=>MO #1(0,1,1)” means that this is a motion detection alert occurring at 02:41:00 PM in Motion Window 2 and Motion Window 3, for camera #1. If the message “PM 02:41:56=>DI #1” is listed, that means there is an alert triggered by the DI, for camera #1, at 02:41:56 PM .

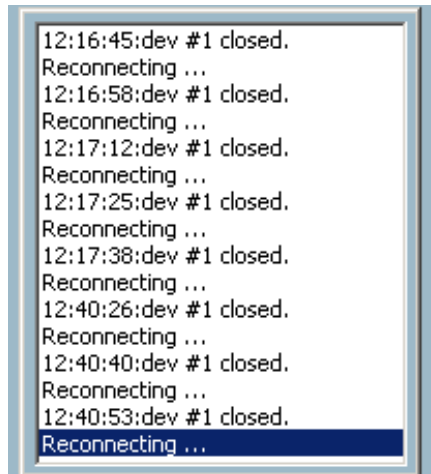

About

By choosing “About”, located in the configuration menu shown below, a dialog box will appear and display the information about the installed version of IP surveillance. The information includes the software name, version, user name, and company.

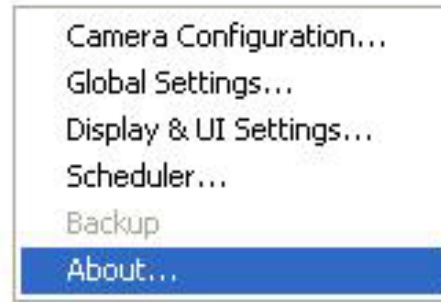

Miscellaneous Functions

This section will describe some other miscellaneous functions of the icons shown below. The icons, from left to right, are Quit, Minimize, Full Screen, Stop Alert Sound, and Configuration Menu.

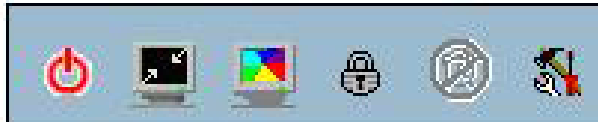

Quit: By clicking this button, IP surveillance will be closed with the latest settings saved.

Minimize: Minimize the Monitor program.

Full Screen: With this function, you can enlarge the selected video channel to a full-screen display. Press the “ESC” key on the keyboard or double click the mouse on the screen to return to a regular display.

Stop Alert Sound: If an alert is triggered, the alert sound will start to play. After being informed of the situation, you can press this button to stop the alert sound. It will also switch the I/O Control to the Alert Message receiver, so that the alert messages can be reviewed.

Configuration Menu: The menu includes Camera Configuration, Global Settings, Scheduler, and About options.

Common Control Functions

This section will describe the common control functions of the icons shown below. These functions only apply to the currently selected channel. The icons, from left to right, are Volume, Record, Stop Record, Snapshot, Printer, and Trash



Volume Control: Click on this button to adjust your volume settings.

Record: By clicking on this button, you can manually record video from the selected channel.

Stop: After video recording has been activated, this button allows you to manually stop recording the selected video channel.

Snapshot: This button will take a snapshot of the selected video channel and then save the picture as a bitmap file to the hard disk. You can set the directory for storing these bitmap files at the “Configuration menu > Global Settings screen”. Please refer to the section titled “Global Settings” for more details.

Printer: Click on the printer icon to print the current image to your default printer.

Trash can: You can drag and drop the video channel to the Trash can to close the video connection with the DCS-3420.

Status Bar

The status bar, shown below, displays important information about the IP surveillance program such as: Local Time, Current Login User, Login Time, Software Name, and Software Version.

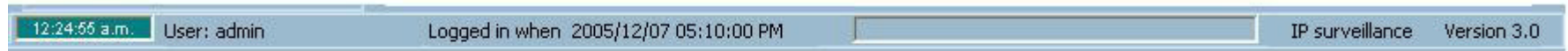

Playback Program

The playback program is a very powerful, convenient, and easy way to browse the recorded video. It has one display mode (normal display mode) and two playback methods (full range and time period). There are several main functions including special features in the Playback program. These functions are depicted as follows.

Features of Playback

Powerful play control tool:

- Play
- Stop
- Pause
- Step forward
- Fast play (from x1 to x16)
- Slow play (from /1 to /16)

Convenient display adjustment tool:

- Zoom in (from 1:1 to 2.25:1)
- Zoom out (from 1:1 to 1:2)
- Full screen

Flexible searching range adjustment tool:

- User input (from full range to 1 second)
- Zoom in (from full range to 10 seconds)
- Zoom out (up to full range)
- Full range

System control tool:

- Window locker
- System settings

Logging In

Before you start the playback program, it is necessary for you to log in to the application software. The figure below shows the login dialog. For security concerns, only the admin account can log in to this program. To change the password of the admin account, please refer to the section titled “Logging In.”

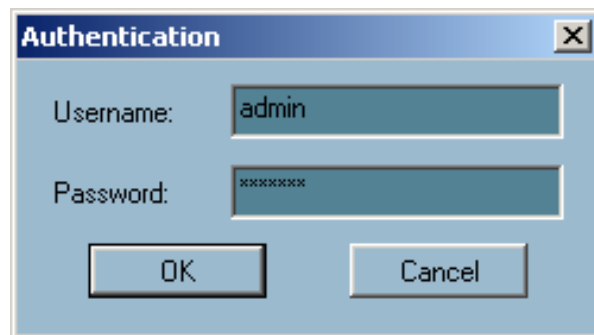

Layout

When you successfully log in to the playback system, the main window will be shown on the top of the screen and the display resolution will be changed to 1024x768 automatically. There are four main areas, i.e. display area, histogram area, control area, and status area. There are also three visualized controls , i.e. area selection indicator, frame selection indicator, and pull bar. These features provide much more convenience while searching recorded video in the IP surveillance database.

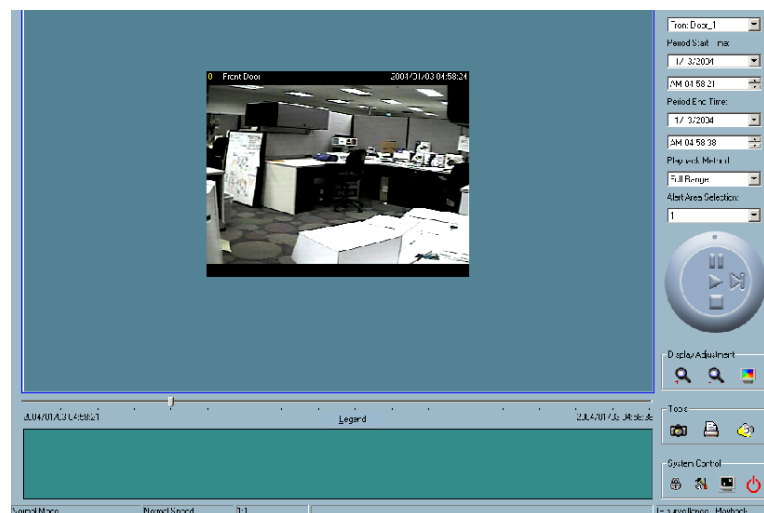

Main Areas

Display Area

The display area is able to show the surveillance database of each camera by time. You can change the video size through the display adjustment tool and the playback method through the play control tool. Under the normal display mode as shown in the figure below, you can just double click on the frame area to change the frame size to 1:1 or 2.25:1.

Histogram Area

The histogram is an interactive control. Not only can you get the event's location in time domain and its quantity of the motion percentage, but you can also select a group of events or a period from the event histogram area and show it on the display area.

Control Area

The control area contains almost all the control selectors and toolboxes you need to browse the database. These control tools include location selector, period selector, playback method selector, jog dial, display adjustment tool, searching range adjustment tool, exporting tool, and system control tool.

Status Area

The status area is located at the bottom of the main window. It tells you the program status information including display mode, display size, display speed, exporting file format, and exporting file name.

Indicators

Area Selection Indicator

In the main playback window, the display area is surrounded by a blue rectangle. This rectangle is the area selection indicator. This indicator can be set to either display area or histogram area, as long as you move your mouse cursor to the area you intend to select. When you select the display area, the display adjustment tool will appear in the control area. If you select the histogram area, the display adjustment tool will disappear and the searching range adjustment tool will be shown in the same place of the control area.

Pull Bar

The pull bar is a fast, flexible control for seeking data in the selected time period. It represents the total length of time in that period. You can pull the indicator on the pull bar to the specific time-point you would like to view. The displaying video will halt and then restart, playing the video sequence from the point you selected. If the video sequence has been paused, the display area will show the point you selected without playing. Note that the pull bar will only function under the normal display mode.

Settings

After the main window is shown on the screen, you must modify the settings to make it to work properly. Click on the “Settings” button, shown below, in the system control tool, and the setting dialog will appear on the screen.

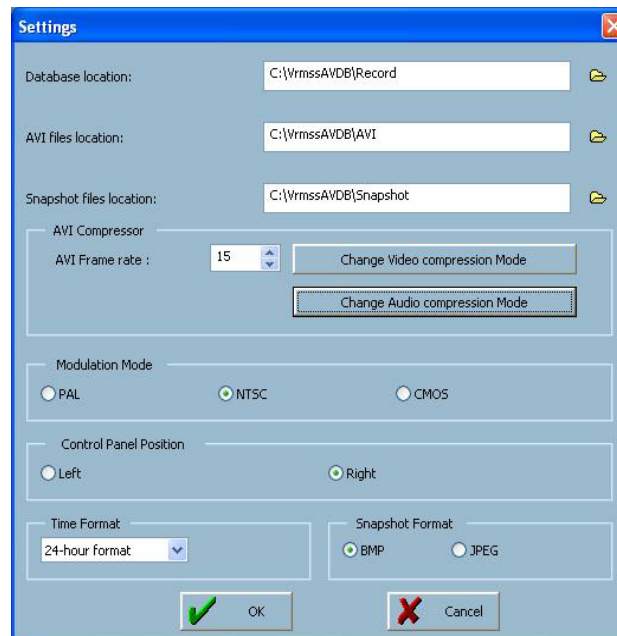
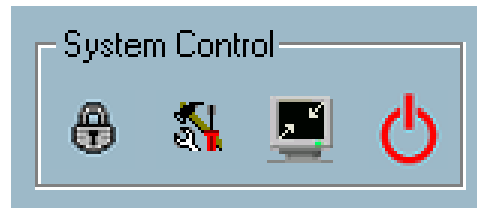

The items in the settings windows are:

Database Location: The most important item in the settings dialog is the database location setting. You must set it to the directory that contains the surveillance database to make the program to work properly.

AVI File Location: This sets the directory where exported AVI files will be stored. Exported AVI files will be stored in the sub-directory (camera name) under the directory you set here.

Snapshot File Location: This sets the directory where bitmap files will be stored when you use the snapshot to export them. Exporting bitmap files will be stored in the sub-directory (camera name) under the directory you set here.

Modulation Mode: The modulation mode cannot be changed. This depends on how you recorded the video sequence in the monitor program. If you select the wrong mode, the video shown in the display area will become distorted. If you have chosen the wrong modulation mode, you may open the settings dialog again, change to the correct mode, and restart the playback program. The display will now be normal.

Normal (Single Frame) Mode

While in the normal (single frame) display mode, you can change the video currently displayed by:

- 1) Changing the database path for retrieving another one in the settings dialog of “System Control” tool.
- 2) Changing the location selector to another location in control area.
- 3) Changing the playback method selector to “Full Range.”
- 4) Changing the playback method selector to “Time Period.”

Under the normal display (single frame) mode, you can use all the tools provided with the playback program, except the page control. In this mode, the two labels under the pull bar show the starting and the ending time of the interval individually (as shown below).

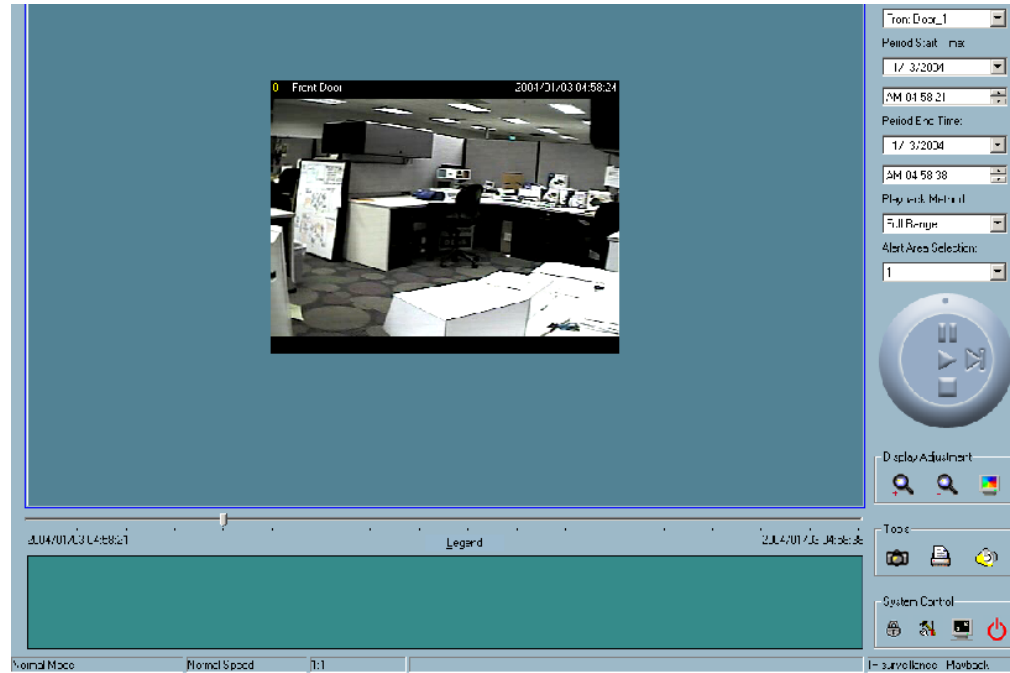

Histogram Area

The histogram area in the normal display (single frame) mode only shows the events' occurred time and the percentage of motion detection with red bars. If you want to access the histogram area, you must change the area selection indicator to the histogram area. You can mark one time interval you want to see with a color-inverted region by dragging your mouse with the left button pressed (as shown below). When you release the left button, the color-inverted region will be enlarged to the whole histogram area. This color-inverted region will be the new period the program is going to display. If you change your mind and don't want to see that period, you can cancel it by just pressing the right button of your mouse with the left button still pressed. If you click on the left button without dragging it, the action will be the same as clicking on the pull bar in the same x-axis position. That means the playback system will shift to the pointed time and show video on the displaying frame. Besides, the dark regions in the histogram area mean there is no existing video data in that interval. If you click on those regions, nothing will happen except a warning message will pop up.

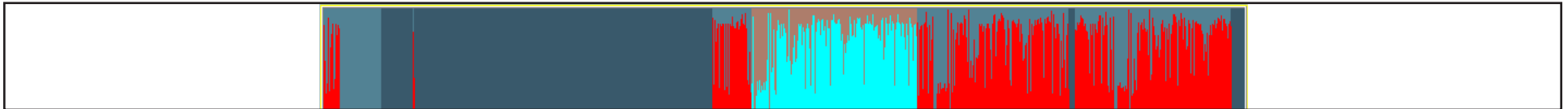

Using Tools

In this section, the method of how to use the tools in the control panel (shown in the main playback window) will be discussed.

Selector Tools

The figure below shows the selector tools. They are location selector, period selector for the selection of the beginning time and the ending time, playback method selector, and alert area selector.

| | |
|-----------------------|---|
| Location: | <input type="text" value="Front Door_1"/> |
| Period Start Time: | <input type="text" value="1/ 3/2004"/> |
| | <input type="text" value="AM 04:58:21"/> |
| Period End Time: | <input type="text" value="1/ 3/2004"/> |
| | <input type="text" value="AM 04:58:38"/> |
| Playback Method: | <input type="text" value="Full Range"/> |
| Alert Area Selection: | <input type="text" value="1"/> |

Location Selector

The location selector is a control that lets you select the camera you want to see (refer to the figure above). The location name is the same as the camera name (text on video) unless you have specified otherwise.

Period Selector

Period selector provides you a precise way to choose the start time and the end time of a new period. The end time must be later than the start time. After you provide the correct start and end time, clicking on the “Play” button in the jog dial will play the new period in the display area with changing the period start and end time label. Besides, the pull bar and histogram area will change, too. If the selected period is not present in the database, the data in the period selector will change to the previous correct start and end time, and a warning message will be displayed.

Playback Method Selector

Since the program will record the previous start and end time in “Time Period” and “Events Preview” mode, whenever you want to change the period selector to see the other periods, you must change the playback method selector to the mode you want to use first. Otherwise, the period selector will revert back to the previous period set the last time you changed the playback method selector.

Full Range: If you select this method, the database will be displayed from the beginning to the end of this location. Any change in the period selector will have no effect except when you change this selector to “Time Period.”

Time Period: If you change the playback method to “Time Period”, you can modify the start and end time in the period selector. When you click on the “Play” button in the jog dial, the period you selected will be displayed.

Alert Area Selector

In the preview mode, the playback program can show the information of total events of only one alert window each time. If you want to see the events of the other two alert area windows, you must change the alert area selector to the other window numbers. In the normal display mode, the alert window that the alert area selector indicates will be highlighted with red rectangle if you checked that window in the settings dialog. The alert area selector will be changed to alert window 0 by default settings when you change the location selector to another window.

Play Control

For the play control, the jog dial, shown in the figure below, is used to provide the easiest method of controlling the video sequence display. All buttons can control the displaying frame in the normal display mode.

Play: The supported “Play” button is an intelligent play user-interface. The functionality of this button can vary to fit different circumstances. In the normal display mode, clicking on the “Play” button can restart the displaying video sequence.

Stop: When you want to stop the displaying video sequence, you can click on the “Stop” button. Note that once you press the “Stop” button, the start point will be reset to the start of the present period.

Pause/Resume: The “Pause” button provides you a way to pause the video sequence display. When the displaying video is paused, click on the “Pause” button again to resume the video display.

Forward: This button is only valid when the displaying video sequence is paused. It will display the next frame in that period when you click on the “Forward” button one time.

Fast Play and Slow Play: The camera supports a maximum of x16 fast forward play and minimum of /16 slow forward play. This function helps you browse the surveillance database with more flexibility. If you want to change the playing speed, you just need to move the speed indicator. To increase playing speed, move the indicator in the clockwise direction. And to decrease playing speed, move it in the counterclockwise direction. The current speed that is set will be shown in the second column of status area.

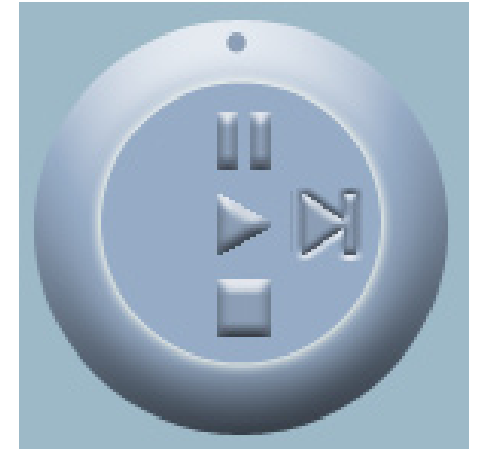

Display Adjustment Tool

When you move the mouse cursor to the displaying area, the display adjustment toolbox will appear. Using the display adjustment toolbox, you can change the displaying video sequence to the size you want to see in the normal display mode when you move the area selection indicator to the display area. The figure below shows the display adjustment toolbox and its own three elements, i.e. “Zoom In”, “Zoom Out”, and “Full Screen.”

Zoom In: When you click on the “Zoom In” button one time, the image size in the display area will be magnified 12.5 percent to the original size. Due to the limitation of the display area size, the maximum zoom in ratio supported is only 2.25:1 for NTSC modulation mode and 1.875:1 for PAL modulation mode. If you want to see the image in more detail, you can use the full screen function that is supported in the same toolbox.



Zoom Out: When you click on the “Zoom Out” button one time, the image size in the display area will be minified 12.5 percent to the original size. To show the location and time information completely, the minimum zoom out ratio is limited in 0.5:1.

Full Screen: When you click on the “Full Screen” button, the video sequence will be enlarged to the whole screen instantly. You can double click on any place or the “ESC” key to return back to the normal screen. When you switch to the full screen display, you can press the “Alt” and “Space” keys together to pop the jog dial to control the displaying video sequence. Press the same keys again to close the jog dial. You can also press the “Alt” and “Enter” keys together to switch between the normal display and full screen display at any time when the program is under the normal display mode.

System Control Toolbox

The system control toolbox provides some basic operations for the playback program. The figure below shows the three elements of the system control toolbox, i.e. “Lock Window”, “Settings”, “Minimize”, and “Exit.”

Lock Window: If you are away from your computer, for security reasons, we recommend that you to close the playback program or you can just click on the “Lock Window” button to lock the main window. Once you click this button, the main window will be hidden and the login dialog will appear. To return to the main window, you need to re-enter the admin’s password again.



Settings: The settings dialog will pop up when you click the “Settings” button. For more information about setting this program, please refer to the section titled “Settings.”

Minimize: Click this button in order to minimize the playback program window.

Exit: The playback program will be closed immediately when you click on the “Exit” button.

Schedule Video Recording

To schedule video recording with motion detection, you must first enable motion detection on the Internet Camera. Click the Motion Detection button under the Advanced tab from the Configuration screen to access settings that affect how the DCS-3420 Internet Camera can serve as a security device by recording only when motion is detected.

Note: These settings can be configured in your Web browser and while logged into the IP surveillance Program.

In this window, follow the steps below to ensure that motion detection is correctly enabled:

- 1 Check “Enable motion detection.”
- 2 Click on “New” to have a new window to monitor video.
- 3 Enter in a window name.
- 4 Adjust the “Sensitivity” and “Percentage” levels according to the local environment. The highest sensitivity and lowest percentage provides the most sensitive setting.
- 5 After adding the motion window, click on save to enable the activity display. You can add up to 3 motion windows to trigger recording.



For detailed information about each setting, please refer to Configuration > Advanced > Motion Detection in the section titled “Using the DCS-3420 With an Internet Browser” (page 30).

Next, run the IP surveillance program. Click on the Configurations button and select Scheduler.

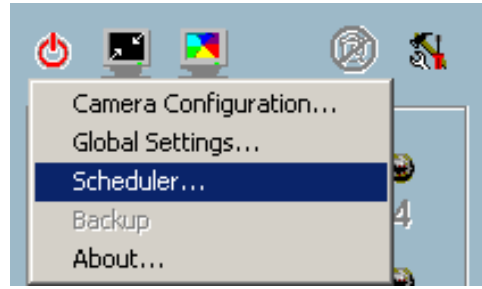

In the Primary Schedule you can choose either Once (for one time recording) or Every Day (for scheduled recording). For example, if you would like to record events every day during a certain time frame, click on the beginning time and drag your mouse to the ending time. Schedule recording can be configured by minutes, hours, days, weeks, or months.

The Secondary Schedule allows you to set a schedule outside the Primary Schedule. The Secondary Schedule provides two options to record without a specified date or time. You can select Event Mode, which will record whenever an event is triggered, or Continuous Mode, which will begin continuously after scheduling settings are saved. You do not need to set the Secondary Schedule with the Primary Schedule. To schedule video recording with motion detection, you can use either the Primary Schedule or Secondary Schedule, or both.

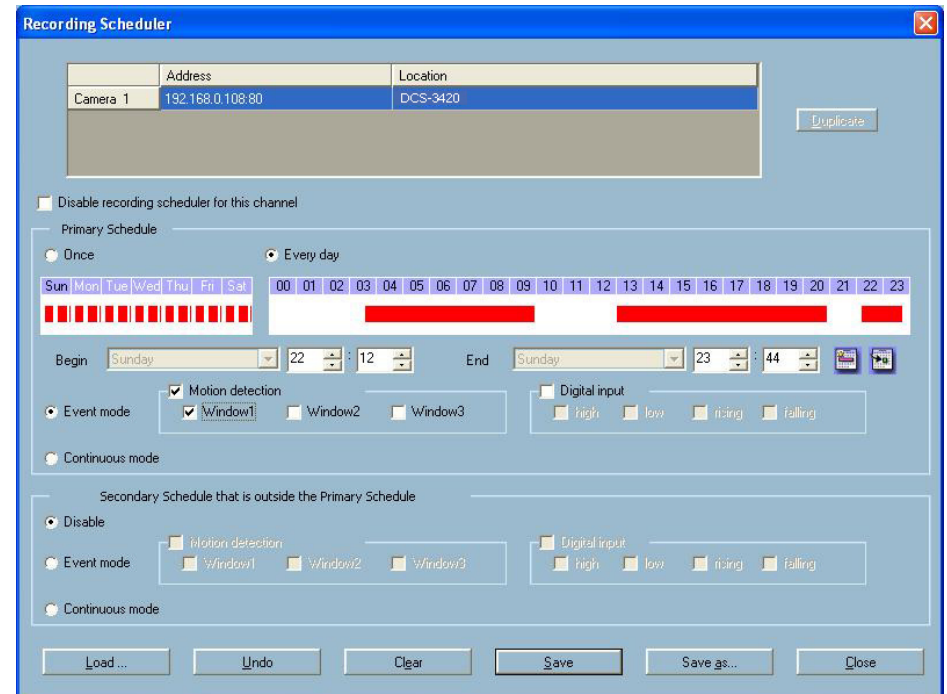

In this window, follow the steps below to schedule video recording with motion detection in the Primary Schedule:

- 1 Check if you want the recording schedule to occur Once or Every day.
- 2 Set the date, time-line, and begin and end times for recording.
- 3 Check Event Mode.
- 4 Select the motion detection window that will be used to trigger motion detection.

Note: *You must first create motion detection windows in the Web configuration page of the camera. Remember the names of the windows and the order in which you created them, as they are not displayed inside the scheduler. Instead, they are listed in the order they were added. For example, the first window created is labeled "Window1."*

- 5 Click on "Disable" under the Secondary Schedule.

Click the Save button when finished. You have now set a schedule to record video when motion detection is triggered. If you would like to save this configuration, click Save As to save this configuration to a folder in your hard drive. This configuration can be used on another system running IP surveillance or can be used as a backup if you need to re-install the IP surveillance software program.

Wireless Security

This section will show you the different levels of security you can use to protect your data from intruders. The DCS-3420 offers the following types of security:

- WPA-PSK (Pre-Shared Key)
- WEP (Wired Equivalent Privacy)

What is WEP?

WEP stands for Wired Equivalent Privacy. It is based on the IEEE 802.11 standard and uses the RC4 encryption algorithm. WEP provides security by encrypting data over your wireless network so that it is protected as it is transmitted from one wireless device to another.

To gain access to a WEP network, you must know the key. The key is a string of characters that you create. When using WEP, you must determine the level of encryption. The type of encryption determines the key length. 128-bit encryption requires a longer key than 64-bit encryption. Keys are defined by entering in a string in HEX (hexadecimal - using characters 0-9, A-F) or ASCII (American Standard Code for Information Interchange – alphanumeric characters) format. ASCII format is provided so you can enter a string that is easier to remember. The ASCII string is converted to HEX for use over the network. Four keys can be defined so that you can change keys easily.

What is WPA?

WPA, or Wi-Fi Protected Access, is a Wi-Fi standard that was designed to improve the security features of WEP (Wired Equivalent Privacy).

The 2 major improvements over WEP:

- Improved data encryption through the Temporal Key Integrity Protocol (TKIP). TKIP scrambles the keys using a hashing algorithm and, by adding an integrity-checking feature, ensures that the keys haven't been tampered with. WPA2 is based on 802.11i and uses Advanced Encryption Standard instead of TKIP.
- User authentication, which is generally missing in WEP, through the extensible authentication protocol (EAP). WEP regulates access to a wireless network based on a computer's hardware-specific MAC address, which is relatively simple to be sniffed out and stolen. EAP is built on a more secure public-key encryption system to ensure that only authorized network users can access the network.

WPA-PSK/WPA2-PSK uses a passphrase or key to authenticate your wireless connection. The key is an alpha-numeric password between 8 and 63 characters long. The password can include symbols (!?*&_) and spaces. This key must be the exact same key entered on your wireless router or access point.

Setting Security

At this point it is highly recommended that you click on the Configuration button on the Home screen, and then the Tools tab to bring you to the Admin screen. Enter a password for security purposes.

To ensure the highest security and prevent unauthorized use of the Internet Camera, the Administrator has the exclusive privilege to access the System Administration settings to allow users entry and authorize privileges for all users. The Internet Camera supports multi-level password protection/access to the Internet Camera that can be restricted to defined users who have a User Name and User Password, which is assigned by the Administrator.

The screenshot displays the D-Link DCS-3420 Web Interface. The page title is "SECURICAM Network Wireless Day&Night Internet Camera". The navigation tabs are Home, Advanced, Tools (selected), Status, and Help. On the left sidebar, there are buttons for Admin (highlighted), System, Applications, and Default. The main content area is titled "Administrator settings" and includes the following sections:

- Administrator's password:** Fields for "New password" and "Confirm password", with a "Save" button.
- Add user:** Fields for "User name" and "User password", and checkboxes for "I/O access", "Talk", and "Listen", with an "Add" button.
- Manage user:** A "User name" dropdown menu (currently showing "-- no user --") and "delete" and "edit" buttons.
- Guest account:** A checkbox labeled "Allow 'demo' account to view".

The Administrator can release a public user name and password so that when remote users access the Internet Camera they will have the right to view the image transmitted by the Internet Camera.

When the Internet Camera is used for the first time, it is highly recommended that the Administrator set the Administrator's Password to constrain user access to the Internet Camera since the Default settings are Null String (no password). Once the Password is defined, only the Administrator has access to the management of the Internet Camera. This procedure should be done as soon as possible since the security features of the Internet Camera will not be enabled until the Administrator Password is defined.

Using & Configuring the DCS-3420

D-Link's DCS-3420 is a versatile and cost effective Internet Camera offering both video and audio monitoring. It can also serve as a powerful surveillance system in security applications. The DCS-3420 can be used with any wired or 802.11g wireless router. This section explains how to view the camera from either the Internet or from inside your internal network.

Materials Needed:

- 1 DCS-3420 Internet Camera
- 1 Ethernet Cable
- A Wired or Wireless router such as the D-Link DI-624 Wireless Router
- Ethernet based PC for system configuration

Setting Up the DCS-3420 For Use Behind a Router

Installing a DCS-3420 Internet Camera on your network is an easy 4–step procedure:

- 1 Assign a Local IP Address to Your Internet Camera
- 2 View the Internet Camera Using Your Internet Explorer Web Browser
- 3 Access the Router with Your Web Browser
- 4 Open Virtual Server Ports to Enable Remote Image Viewing

This section is designed to walk you through the setup process for installing your camera behind a router and enable remote video viewing. For the basic setup of the DCS-3420, follow the steps outlined in the Quick Installation Guide.

After you have completed the setup of the DCS-3420 outlined in the Quick Installation Guide you will have an operating camera that has an assigned IP Address. Because you are using a router to share the Internet with one or more PCs, the IP Address assigned to the Internet Camera will be a local IP Address. This allows viewing within your Local Area Network (LAN) until the router is configured to allow remote viewing of the camera over the Internet.

1 Assign a Local IP Address to Your Camera

Run the Installation Wizard program from the CD included with the DCS-3420. Follow the steps in the Quick Installation Guide to configure the DCS-3420. The camera will be assigned a local IP Address that allows it to be recognized by the router. Write down this IP Address for future reference.

This is the IP Address assigned to your camera. Write it down for later use. 192.168.0.120 is only an example. You will probably have a different IP Address.

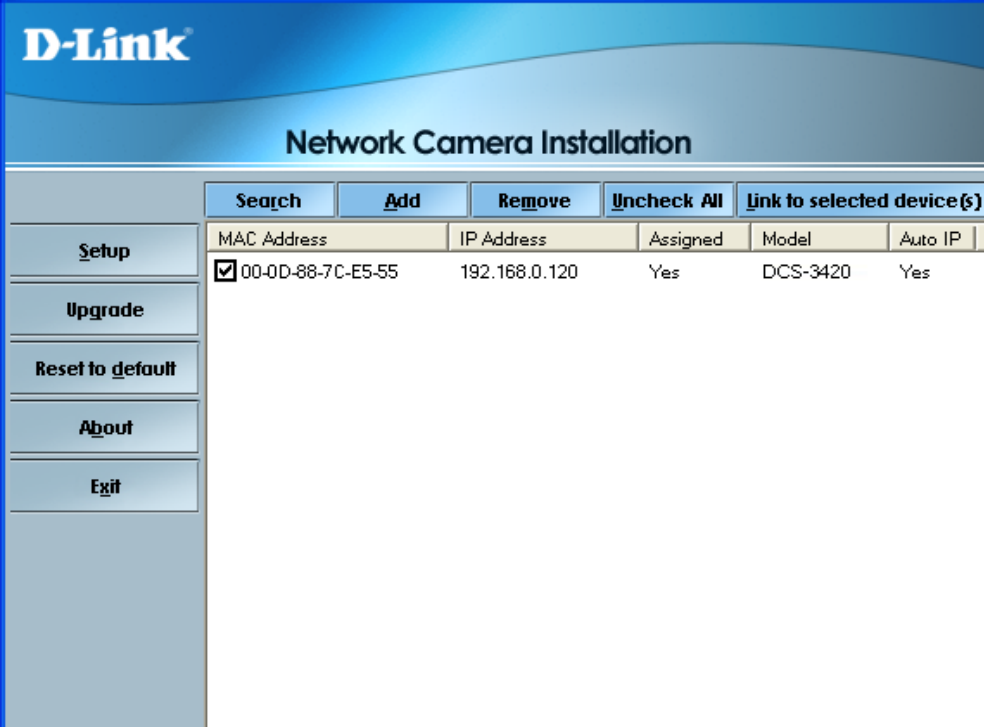

| | Search | Add | Remove | Uncheck All | Link to selected device(s) | |
|-------------------------|-------------------------------------|-------------------|---------------|-------------|----------------------------|-----|
| Setup | MAC Address | IP Address | Assigned | Model | Auto IP | |
| Upgrade | <input checked="" type="checkbox"/> | 00-0D-88-7C-E5-55 | 192.168.0.120 | Yes | DCS-3420 | Yes |
| Reset to default | | | | | | |
| About | | | | | | |
| Exit | | | | | | |

2 View the Internet Camera Using Your Internet Explorer Web Browser

Run your Internet Explorer Web browser. In the address bar, type in the IP Address that was assigned to the Internet Camera by the Installation Wizard program. The DCS-3420 Home Page appears with a window displaying live video from the camera. You are able to view this screen from any PC running Internet Explorer on your LAN.

Click on the Configuration button on the left side of the display. Scroll to the bottom of the Network Configuration page (see page 127) to display the ports used by HTTP and Streaming audio and video.

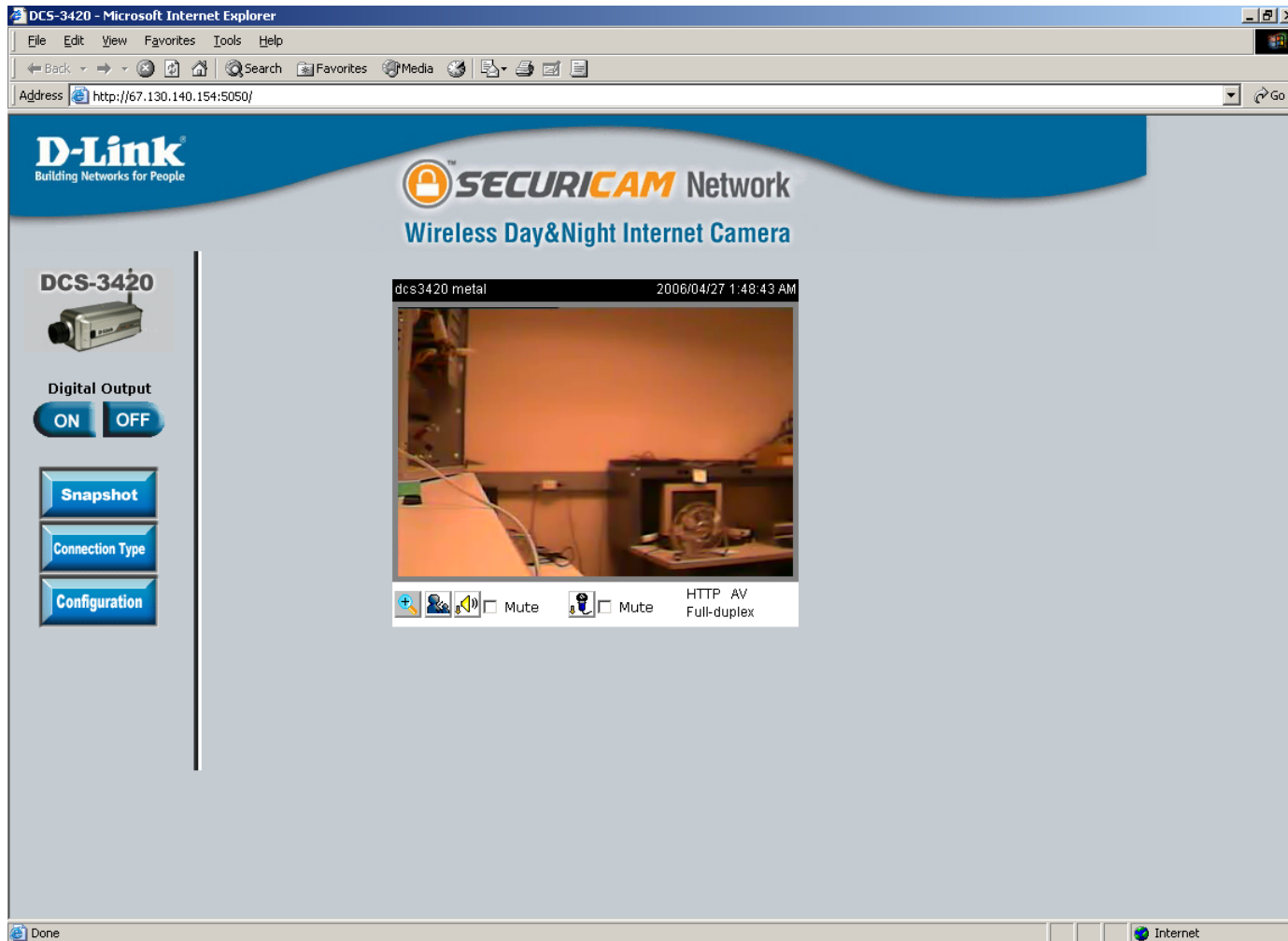

The Advanced > Network page displays the port settings for your camera. If necessary, these ports can be changed if they are already in use by other devices (e.g. in a multiple camera environment).

Note: HTTP port, UDP Audio Channel port and UDP Video channel port needs to be opened for the DCS-3420. Please refer to page 129 for instruction.



D-Link
Building Networks for People

SECURICAM Network
Wireless Day&Night Internet Camera

DCS-3420

Home **Advanced** Tools Status Help

Network settings

Network type

LAN

Reset the IP address at next boot

IP address

Subnet mask

Default router

Primary DNS

Secondary DNS

PPPoE

User name

Password

Confirm password

HTTP

HTTP port

Streaming

UDP Audio channel port

UDP Video channel port

Router Set-Up and Installation

The following steps generally apply to any router that you have on your network. The D-Link DI-624 is used as an example to clarify the configuration process. Configure the initial settings of the DI-624 by following the steps outlined in the DI-624 Quick Installation Guide.

3 Access the Router with Your Web Browser

If you have cable or DSL Internet service, you will most likely have a dynamically assigned WAN IP Address. 'Dynamic' means that your router's WAN IP address can change from time to time depending on your ISP. A dynamic WAN IP Address identifies your router on the public network and allows it to access the Internet. To find out what your router's WAN IP Address is, go to the Status menu on your router and locate the WAN information for your router (as shown on the next page). The WAN IP Address will be listed. This will be the address that you will need to type in your Web browser to view your camera over the Internet.

Your WAN IP Address will be listed on the router's Status > Device Info page.



The screenshot shows the D-Link DI-624 web interface. The top navigation bar includes Home, Advanced, Tools, Status (selected), and Help. The main content area is titled "Device Information" and shows the following details:

- Device Information:** Firmware Version: 1.00, Tue, 24 Dec 2002
- LAN:**
 - MAC Address: 00-03-2F-FF-F0-85
 - IP Address: 192.168.0.1
 - Subnet Mask: 255.255.255.0
 - DHCP Server: Enabled
- WAN:**
 - MAC Address: 00-03-2F-FF-F0-86
 - Connection: DHCP Client Connected (with DHCP Release and DHCP Renew buttons)
 - IP Address: 10.80.1.94
 - Subnet Mask: 255.0.0.0
 - Default Gateway: 10.10.10.100
 - DNS: 10.10.10.41, 10.10.10.45, 192.152.81.1
- Wireless 802.11g:**
 - MAC Address: 00-60-B3-06-00-32
 - SSID: GiGi

Note: *Because a dynamic WAN IP can change from time to time depending on your ISP, you may want to obtain a Static IP address from your ISP. A Static IP address is a fixed IP address that will not change over time and will be more convenient for you to use to access your camera from a remote location. The Static IP Address will also allow you to access your camera attached to your router over the Internet.*

4 Open Virtual Server Ports to Enable Remote Image Viewing

The firewall security features built into the DI-624 router prevent users from accessing the video from the DCS-3420 over the Internet. The router connects to the Internet over a series of numbered ports. The ports normally used by the DCS-3420 are blocked from access over the Internet. Therefore, these ports need to be made accessible over the Internet. This is accomplished using the Virtual Server function on the DI-624 router. The Virtual Server ports used by the camera must be opened through the router for remote access to your camera. Virtual Server is accessed by clicking on the Advanced tab of the router screen.

Follow these steps to configure your router's Virtual Server settings:

- 1 Click Enabled.
- 2 Enter a different name for each entry.
- 3 Enter your camera's local IP Address (e.g., 192.168.0.120 in the example in step 2 on page 129) in the Private IP field.
- 4 Select TCP for HTTP port and both (TCP and UDP) for Audio and Video channel port.
- 5 If you are using the default camera port settings, enter 80 into the Public and Private Port section, click Apply.
- 6 Scheduling should be set to Always so that the camera images can be accessed at any time.

Repeat the above steps adding the port 5002 and 5003 to both the Public and Private Port sections. A check mark appearing before the entry name will indicate that the ports are enabled.

Important: Some ISPs block access to port 80 and other commonly used Internet ports to conserve bandwidth. Check with your ISP so that you can open the appropriate ports accordingly. If your ISP does not pass traffic on port 80, you will need to change the port the camera uses from 80 to something else, such as 800. Not all routers are the same, so refer to your user manual for specific instructions on how to open ports.

Enter valid ports in the Virtual Server section of your router. Please make sure to check the box next to the camera name on the Virtual Server List to enable your settings.

D-Link
Building Networks for People

AirPlus Xtreme G™
High-Speed 2.4GHz Wireless Router

DI-624

Virtual Server

Applications

Filters

Firewall

DMZ

Performance

Home Advanced Tools Status Help

Virtual Server

Virtual Server is used to allow Internet users access to LAN services.

Enabled Disabled

Name:

Private IP:

Protocol Type:

Private Port:

Public Port:

Schedule: Always

From time : AM to : AM

day to

Virtual Servers List

| Name | Private IP | Protocol | Schedule | |
|---|------------|-------------|----------|--|
| <input type="checkbox"/> Virtual Server FTP | 0.0.0.0 | TCP 21/21 | always | <input type="button" value="Apply"/> <input type="button" value="Cancel"/> <input type="button" value="Help"/> |
| <input type="checkbox"/> Virtual Server HTTP | 0.0.0.0 | TCP 80/80 | always | <input type="button" value="Apply"/> <input type="button" value="Cancel"/> <input type="button" value="Help"/> |
| <input type="checkbox"/> Virtual Server HTTPS | 0.0.0.0 | TCP 443/443 | always | <input type="button" value="Apply"/> <input type="button" value="Cancel"/> <input type="button" value="Help"/> |
| <input type="checkbox"/> Virtual Server DNS | 0.0.0.0 | UDP 53/53 | always | <input type="button" value="Apply"/> <input type="button" value="Cancel"/> <input type="button" value="Help"/> |

Troubleshooting

1. What is an Internet Camera?

The Internet Camera is a stand-alone system connecting directly to an Ethernet or Fast Ethernet network. It differs from a conventional PC Camera, the Internet Camera is an all-in-one system with built-in CPU and Web-based solutions providing a low cost solution that can transmit high quality video images for monitoring. The Internet Camera can be managed remotely, accessed and controlled from any PC/Notebook over an Intranet or the Internet from a Web browser.

2. What is the maximum number of users that can be allowed to access DCS-3420 simultaneously?

The maximum number of users that can log onto the Internet Camera at the same time is 10. Please keep in mind the overall performance of the transmission speed will slow down when many users are logged on.

3. What algorithm is used to compress the digital image?

The Internet Camera utilizes MPEG-4 simple profile image compression technology to provide high quality images.

4. Can I capture still images from the Internet Camera?

Yes you are able to capture still images with the snapshot function from the software application CD supplied with the Internet Camera or with the snapshot function on the Home page using an Internet browser.

5. Can the Internet Camera be used outdoors?

The Internet Camera is not weatherproof. It needs to be equipped with a weatherproof case to be used outdoors and it is not recommended.

6. When physically connecting the Internet Camera to a network what network cabling is required?

The Internet Camera uses Category 5 UTP cable allowing 10 Base-T and 100 Base-T networking.

7. Can the Internet Camera be setup as a PC-cam on a computer?

No, the DCS-3420 Internet Camera is used only on an wireless 802.11g, Ethernet or Fast Ethernet network.

8. Can the DCS-3420 be connected to the network if it consists of only private IP addresses?

Yes, the Internet Camera can be connected to a LAN with private IP addresses.

9. Can the DCS-3420 be installed and work if a firewall exists on the network?

If a firewall exists on the network, port 80 is open for ordinary data communication. The DCS-3420 uses port 5002 for streaming audio and port 5003 for streaming video. These ports (or the ports you specify from the Advanced Tab in the Configuration screen if you change the default ports) need to be opened on the firewall. Please refer to page 129 for more information.

10. Why am I unable to access the DCS-3420 from a Web browser?

If a router or firewall is used on the network, the correct ports for the DCS-3420 may not be configured on the router or firewall. To correct the problem, you need to determine if the DCS-3420 is behind a router or firewall and if the router or firewall is properly configured for the ports the DCS-3420 is using. Refer to page 129 for help in opening the correct ports on a router or firewall for use with the DCS-3420. Other possible problems might be due to the network cable. Try replacing your network cable. Test the network interface of the product by connecting a local computer to the unit, utilizing a Ethernet crossover cable. If the problem is not solved the Internet Camera might be faulty.

11. Why does the Internet Camera work locally but not externally?

This might be caused by network firewall protection. The firewall may need to have some settings changed in order for the Internet Camera to be accessible outside your local LAN. Check with the Network Administrator for your network.

Make sure that the Internet Camera isn't conflicting with any Web server you may have running on your network. The default router setting might be a possible reason. Check that the configuration of the router settings allow the Internet Camera to be accessed outside your local LAN. Please refer to page 129 for more information.

12. I connected the Internet Camera directly to a computer with a cross-over cable Ethernet cable and received the following Windows error upon running the Installation Wizard:

This Windows error will occur if the Internet Camera is connected to a computer that is not properly configured with a valid IP address. Turn off DHCP from the Network Settings in Windows and configure the computer with a valid IP address, or connect the camera to a router with DHCP enabled. (See page 140)

This error can also occur if the Installation Wizard icon is clicked on more than once from the setup wizard.



13. Noisy images occur. How can I solve the problem?

The video images might be noisy if the Internet Camera is used in a very low light environment. To solve this issue you need more lighting.

13. The images appear to be of poor quality, how can I improve the image quality?

Make sure that your computer's display properties are set above 256 colors. Using 16 or 256 colors on your computer will produce dithering artifacts in the image, making the image appear to be of poor quality.

The configuration on the Internet Camera image display is incorrect. Through the Advanced > Image Setting section of the Web management you need to adjust the image related parameters such as brightness, contrast, hue and power line frequency for fluorescent light. Please refer to the Advanced > Image Setting section on Page 44 for detailed information.

Wireless Basics

D-Link wireless products are based on industry standards to provide easy-to-use and compatible high-speed wireless connectivity within your home, business or public access wireless networks. Strictly adhering to the IEEE standard, the D-Link wireless family of products will allow you to securely access the data you want, when and where you want it. You will be able to enjoy the freedom that wireless networking delivers.

A wireless local area network (WLAN) is a cellular computer network that transmits and receives data with radio signals instead of wires. Wireless LANs are used increasingly in both home and office environments, and public areas such as airports, coffee shops and universities. Innovative ways to utilize WLAN technology are helping people to work and communicate more efficiently. Increased mobility and the absence of cabling and other fixed infrastructure have proven to be beneficial for many users.

Under many circumstances, it may be desirable for mobile network devices to link to a conventional Ethernet LAN in order to use servers, printers or an Internet connection supplied through the wired LAN. A Wireless Router is a device used to provide this link.

What is Wireless?

Wireless or WiFi technology is another way of connecting your computer to the network without using wires. WiFi uses radio frequency to connect wirelessly, so you have the freedom to connect computers anywhere in your home or office network.

Why D-Link Wireless?

D-Link is the worldwide leader and award winning designer, developer, and manufacturer of networking products. D-Link delivers the performance you need at a price you can afford. D-Link has all the products you need to build your network.

How does wireless work?

Wireless works similar to how cordless phone work, through radio signals to transmit data from one point A to point B. But wireless technology has restrictions as to how you can access the network. You must be within the wireless network range area to be able to connect your computer. There are two different types of wireless networks Wireless Local Area Network (WLAN), and Wireless Personal Area Network (WPAN).

Wireless Local Area Network (WLAN)

In a wireless local area network, a device called an Access Point (AP) connects computers to the network. The access point has a small antenna attached to it, which allows it to transmit data back and forth over radio signals. With an indoor access point as seen in the picture, the signal can travel up to 300 feet. With an outdoor access point the signal can reach out up to 30 miles to serve places like manufacturing plants, industrial locations, college and high school campuses, airports, golf courses, and many other outdoor venues.

Who uses wireless?

Wireless technology has become so popular in recent years that almost everyone is using it, whether it's for home, office, business, D-Link has a wireless solution for it.

Home

- Gives everyone at home broadband access
- Surf the web, check email, instant message, and etc
- Gets rid of the cables around the house
- Simple and easy to use

Small Office and Home Office

- Stay on top of everything at home as you would at office
- Remotely access your office network from home
- Share Internet connection and printer with multiple computers
- No need to dedicate office space

Where is wireless used?

Wireless technology is expanding everywhere not just at home or office. People like the freedom of mobility and it's becoming so popular that more and more public facilities now provide wireless access to attract people. The wireless connection in public places is usually called "hotspots".

Using a D-Link Cardbus Adapter with your laptop, you can access the hotspot to connect to Internet from remote locations like: Airports, Hotels, Coffee Shops, Libraries, Restaurants, and Convention Centers.

Wireless network is easy to setup, but if you're installing it for the first time it could be quite a task not knowing where to start. That's why we've put together a few setup steps and tips to help you through the process of setting up a wireless network.

Tips

Here are a few things to keep in mind, when you install a wireless network.

Centralize your router or Access Point

Make sure you place the router/access point in a centralized location within your network for the best performance. Try to place the router/access point as high as possible in the room, so the signal gets dispersed throughout your home. If you have a two-story home, you may need a repeater to boost the signal to extend the range.

Eliminate Interference

Place home appliances such as cordless telephones, microwaves, and televisions as away as possible from the router/access point. This would significantly reduce any interfere that the appliances might cause since they operate on same frequency.

Security

Don't let your next-door neighbors or intruders connect to your wireless network. Secure your wireless network by turning on the WPA or WEP security feature on the router. Refer to product manual for detail information on how to set it up.

Wireless Modes

There are basically two modes of networking:

- **Infrastructure** – All wireless clients will connect to an access point or wireless router.
- **Ad-Hoc** – Directly connecting to another computer, for peer-to-peer communication, using wireless network adapters on each computer, such as two or more DCS-3420 wireless network Cardbus adapters.

An Infrastructure network contains an Access Point or wireless router. All the wireless devices, or clients, will connect to the wireless router or access point.

An Ad-Hoc network contains only clients, such as laptops with wireless cardbus adapters. All the adapters must be in Ad-Hoc mode to communicate.

Networking Basics

Check your IP address

After you install your new D-Link adapter, by default, the TCP/IP settings should be set to obtain an IP address from a DHCP server (i.e. wireless router) automatically. To verify your IP address, please follow the steps below.

Click on **Start > Run**. In the run box type **cmd** and click **OK**.

At the prompt, type **ipconfig** and press **Enter**.

This will display the IP address, subnet mask, and the default gateway of your adapter.

If the address is 0.0.0.0, check your adapter installation, security settings, and the settings on your router. Some firewall software programs may block a DHCP request on newly installed adapters.

If you are connecting to a wireless network at a hotspot (e.g. hotel, coffee shop, airport), please contact an employee or administrator to verify their wireless network settings.

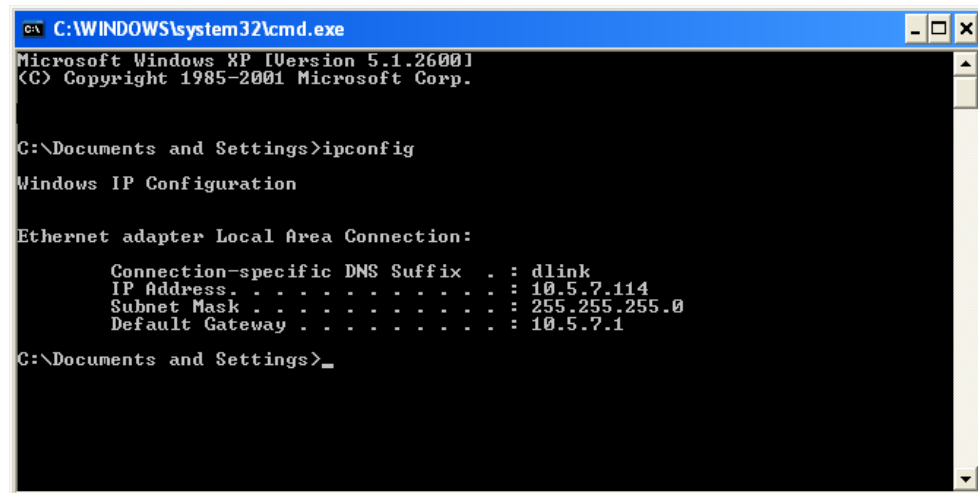

```
C:\WINDOWS\system32\cmd.exe
Microsoft Windows XP [Version 5.1.2600]
(C) Copyright 1985-2001 Microsoft Corp.

C:\Documents and Settings>ipconfig

Windows IP Configuration

Ethernet adapter Local Area Connection:

    Connection-specific DNS Suffix  . : dlink
    IP Address. . . . .                : 10.5.7.114
    Subnet Mask . . . . .              : 255.255.255.0
    Default Gateway . . . . .          : 10.5.7.1

C:\Documents and Settings>_
```

Statically Assign an IP address

If you are not using a DHCP capable gateway/router, or you need to assign a static IP address, please follow the steps below:

Step 1

Windows® XP - Click on **Start > Control Panel > Network Connections**.

Windows® 2000 - From the desktop, right-click **My Network Places > Properties**.

Step 2

Right-click on the **Local Area Connection** which represents your D-Link network adapter and select **Properties**.

Step 3

Highlight **Internet Protocol (TCP/IP)** and click **Properties**.

Step 4

Click **Use the following IP address** and enter an IP address that is on the same subnet as your network or the LAN IP address on your router.

Example: If the router's LAN IP address is 192.168.0.1, make your IP address 192.168.0.X where X is a number between 2 and 99. Make sure that the number you choose is not in use on the network. Set Default Gateway the same as the LAN IP address of your router (192.168.0.1).

Set Primary DNS the same as the LAN IP address of your router (192.168.0.1). The Secondary DNS is not needed or you may enter a DNS server from your ISP.

Step 5

Click OK twice to save your settings.

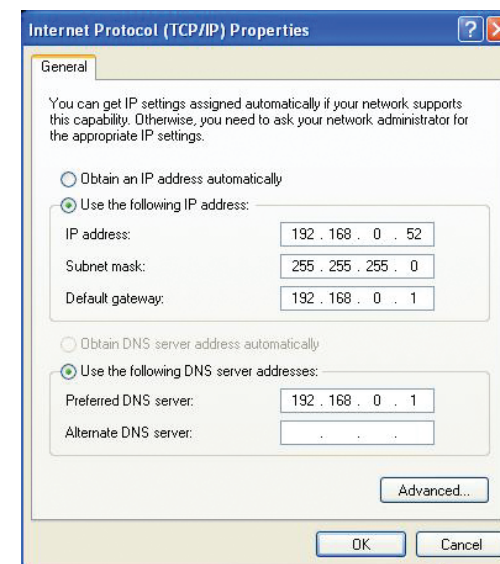

Technical Specifications

Remote management

- Camera configuration and Camera system log can be accessed remotely via Internet Explorer 6.x or above Web browser.

Networking Protocol

- TCP/IP, HTTP, SMTP, FTP, NTP, DNS, DHCP, DDNS, and UPnP

Ethernet

- 10BaseT or 100BaseT Fast Ethernet auto-negotiation

WLAN

- 2.4GHz 802.11g DSSS CSMA/CA Protocol
- Bit rate: up to 54Mbps*
- Security: Up to 128-bit WEP, WPA-PSK

Antenna

- 2.4Ghz swivel type, monopole

Frequency

- 2.4Ghz-2.5Ghz

Impedance

- 50 Ohms nominal

Gain

- 2dBi typical

Video Algorithm supported

- MPEG-4 Simple Profile Mode
- MJPEG

Audio

- 8Kbps ~ 32Kbps
- Acoustic echo cancellation
- Full duplex audio communication

Video resolution

- Up to 30 fps at 176x120 / 176x144
- Up to 30 fps at 352x240 / 352x288
- Up to 10 fps at 704x480 / 704x576

General I/O

- 1 opto-isolated sensor input (max. 12VDC 50mA)
- 1 relay output (max. 24VDC 1A, 125VAC 0.5A)

Security

- Administrator and User Group Protected
- Password Authentication

Led Indicator

- Bi-color status indicator

Camera specification

- 1/3 inch color CCD sensor
- 0.5 Lux/F2.0
- AGC/AWB/AES/BLC
- Electronic shutter: 1/60 ~ 1/100,000 second
- Standard CS mount type lens, 6mm, F2.0
- Supports DC iris lens
- Supports day and night IR lens

Power

- 12VDC 1.5A, external power supply
- Consumption: MAX 9.4W

Weight

- 1.2 Lb.

Dimension

- 6.7" L x 3.15" W x 2.36" H

Viewing system requirement

- **Protocol:** Standard TCP/IP Internet Suite ActiveX
- **Operating System:** Microsoft Windows XP/2000
- **Browser:** Internet Explorer 6.x or above

Environmental

- Operating: 32° to 102° F
- Storage: -4° to 158° F
- Humidity: Max 85% RH

Safety

- FCC class B
- CE

Warranty

1-Year

*Maximum wireless signal rate derived from IEEE Standard 802.11g specifications. Actual data throughput will vary. Network conditions and environmental factors, including volume of network traffic, building materials and construction, and network overhead, lower actual data throughput rate. Environmental factors will adversely affect wireless signal range.

Contacting Technical Support

You can find software updates and user documentation on the D-Link website.

D-Link provides free technical support for customers within the United States and within Canada for the duration of the warranty period on this product.

U.S. and Canadian customers can contact D-Link technical support through our web site, or by phone.

Tech Support for customers within the United States:

D-Link Technical Support over the Telephone:

(877) 453-5465

24 hours a day, seven days a week.

D-Link Technical Support over the Internet:

<http://support.dlink.com/contact/>

Tech Support for customers within Canada:

D-Link Technical Support over the Telephone:

(800) 361-5265

Monday to Friday 7:30am to 9:00pm EST

D-Link Technical Support over the Internet:

<http://support.dlink.ca>

Warranty

Subject to the terms and conditions set forth herein, D-Link Systems, Inc. (“D-Link”) provides this Limited Warranty:

- Only to the person or entity that originally purchased the product from D-Link or its authorized reseller or distributor, and
- Only for products purchased and delivered within the fifty states of the United States, the District of Columbia, U.S. Possessions or Protectorates, U.S. Military Installations, or addresses with an APO or FPO.

Limited Warranty:

D-Link warrants that the hardware portion of the D-Link product described below (“Hardware”) will be free from material defects in workmanship and materials under normal use from the date of original retail purchase of the product, for the period set forth below (“Warranty Period”), except as otherwise stated herein.

- Hardware (excluding power supplies and fans): One (1) year
- Power supplies and fans: One (1) year
- Spare parts and spare kits: Ninety (90) days

The customer’s sole and exclusive remedy and the entire liability of D-Link and its suppliers under this Limited Warranty will be, at D-Link’s option, to repair or replace the defective Hardware during the Warranty Period at no charge to the original owner or to refund the actual purchase price paid. Any repair or replacement will be rendered by D-Link at an Authorized D-Link Service Office. The replacement hardware need not be new or have an identical make, model or part. D-Link may, at its option, replace the defective Hardware or any part thereof with any reconditioned product that D-Link reasonably determines is substantially equivalent (or superior) in all material respects to the defective Hardware. Repaired or replacement hardware will be warranted for the remainder of the original Warranty Period or ninety (90) days, whichever is longer, and is subject to the same limitations and exclusions. If a material defect is incapable of correction, or if D-Link determines that it is not practical to repair or replace the defective Hardware, the actual price paid by the original purchaser for the defective Hardware will be refunded by D-Link upon return to D-Link of the defective Hardware. All Hardware or part thereof that is replaced by D-Link, or for which the purchase price is refunded, shall become the property of D-Link upon replacement or refund.

Limited Software Warranty:

D-Link warrants that the software portion of the product (“Software”) will substantially conform to D-Link’s then current functional specifications for the Software, as set forth in the applicable documentation, from the date of original retail purchase of the Software for a period of ninety (90) days (“Software Warranty Period”), provided that the Software is properly installed on approved hardware and operated as contemplated in its documentation. D-Link further warrants that, during the Software Warranty Period, the magnetic media on which D-Link delivers the Software will be free of physical defects. The customer’s sole and exclusive remedy and the entire liability of D-Link and its suppliers under this Limited Warranty will be, at D-Link’s option, to replace the non-conforming Software (or defective media) with software that substantially conforms to D-Link’s functional specifications for the Software or to refund the portion of the actual purchase price paid that is attributable to the Software. Except as otherwise agreed by DLink in writing, the replacement Software is provided only to the original licensee, and is subject to the terms and conditions of the license granted by D-Link for the Software. Replacement Software will be warranted for the remainder of the original Warranty Period and is subject to the same limitations and exclusions. If a material non-conformance is incapable of correction, or if D-Link determines in its sole discretion that it is not practical to replace the non-conforming Software, the price paid by the original licensee for the non-conforming Software will be refunded by D-Link; provided that the non-conforming Software (and all copies thereof) is first returned to D-Link. The license granted respecting any Software for which a refund is given automatically terminates.

Non-Applicability of Warranty:

The Limited Warranty provided hereunder for Hardware and Software portions of D-Link’s products will not be applied to and does not cover any refurbished product and any product purchased through the inventory clearance or liquidation sale or other sales in which D-Link, the sellers, or the liquidators expressly disclaim their warranty obligation pertaining to the product and in that case, the product is being sold “As-Is” without any warranty whatsoever including, without limitation, the Limited Warranty as described herein, notwithstanding anything stated herein to the contrary.

Submitting A Claim:

The customer shall return the product to the original purchase point based on its return policy. In case the return policy period has expired and the product is within warranty, the customer shall submit a claim to D-Link as outlined below:

- The customer must submit with the product as part of the claim a written description of the Hardware defect or Software nonconformance in sufficient detail to allow DLink to confirm the same, along with proof of purchase of the product (such as a copy of the dated purchase invoice for the product) if the product is not registered.
- The customer must obtain a Case ID Number from D-Link Technical Support at 1-877-453-5465, who will attempt to assist the customer in resolving any suspected defects with the product. If the product is considered defective, the customer must obtain a Return Material Authorization (“RMA”) number by completing the RMA form and entering the assigned Case ID Number at <https://rma.dlink.com/>.

- After an RMA number is issued, the defective product must be packaged securely in the original or other suitable shipping package to ensure that it will not be damaged in transit, and the RMA number must be prominently marked on the outside of the package. Do not include any manuals or accessories in the shipping package. DLink will only replace the defective portion of the product and will not ship back any accessories.
- The customer is responsible for all in-bound shipping charges to D-Link. No Cash on Delivery (“COD”) is allowed. Products sent COD will either be rejected by D-Link or become the property of D-Link. Products shall be fully insured by the customer and shipped to D-Link Systems, Inc., 17595 Mt. Herrmann, Fountain Valley, CA 92708. D-Link will not be held responsible for any packages that are lost in transit to D-Link. The repaired or replaced packages will be shipped to the customer via UPS Ground or any common carrier selected by D-Link. Return shipping charges shall be prepaid by D-Link if you use an address in the United States, otherwise we will ship the product to you freight collect. Expedited shipping is available upon request and provided shipping charges are prepaid by the customer. D-Link may reject or return any product that is not packaged and shipped in strict compliance with the foregoing requirements, or for which an RMA number is not visible from the outside of the package. The product owner agrees to pay D-Link’s reasonable handling and return shipping charges for any product that is not packaged and shipped in accordance with the foregoing requirements, or that is determined by D-Link not to be defective or non-conforming.

What Is Not Covered:

The Limited Warranty provided herein by D-Link does not cover:

Products that, in D-Link’s judgment, have been subjected to abuse, accident, alteration, modification, tampering, negligence, misuse, faulty installation, lack of reasonable care, repair or service in any way that is not contemplated in the documentation for the product, or if the model or serial number has been altered, tampered with, defaced or removed; Initial installation, installation and removal of the product for repair, and shipping costs; Operational adjustments covered in the operating manual for the product, and normal maintenance; Damage that occurs in shipment, due to act of God, failures due to power surge, and cosmetic damage; Any hardware, software, firmware or other products or services provided by anyone other than D-Link; and Products that have been purchased from inventory clearance or liquidation sales or other sales in which D-Link, the sellers, or the liquidators expressly disclaim their warranty obligation pertaining to the product.

While necessary maintenance or repairs on your Product can be performed by any company, we recommend that you use only an Authorized D-Link Service Office. Improper or incorrectly performed maintenance or repair voids this Limited Warranty.

Disclaimer of Other Warranties:

EXCEPT FOR THE LIMITED WARRANTY SPECIFIED HEREIN, THE PRODUCT IS PROVIDED “AS-IS” WITHOUT ANY WARRANTY OF ANY KIND WHATSOEVER INCLUDING, WITHOUT LIMITATION, ANY WARRANTY OF MERCHANTABILITY, FITNESS FOR A PARTICULAR PURPOSE AND NONINFRINGEMENT.

IF ANY IMPLIED WARRANTY CANNOT BE DISCLAIMED IN ANY TERRITORY WHERE A PRODUCT IS SOLD, THE DURATION OF SUCH IMPLIED WARRANTY SHALL BE LIMITED TO THE DURATION OF THE APPLICABLE WARRANTY PERIOD SET FORTH ABOVE. EXCEPT AS EXPRESSLY COVERED UNDER THE LIMITED WARRANTY PROVIDED HEREIN, THE ENTIRE RISK AS TO THE QUALITY, SELECTION AND PERFORMANCE OF THE PRODUCT IS WITH THE PURCHASER OF THE PRODUCT.

Limitation of Liability:

TO THE MAXIMUM EXTENT PERMITTED BY LAW, D-LINK IS NOT LIABLE UNDER ANY CONTRACT, NEGLIGENCE, STRICT LIABILITY OR OTHER LEGAL OR EQUITABLE THEORY FOR ANY LOSS OF USE OF THE PRODUCT, INCONVENIENCE OR DAMAGES OF ANY CHARACTER, WHETHER DIRECT, SPECIAL, INCIDENTAL OR CONSEQUENTIAL (INCLUDING, BUT NOT LIMITED TO, DAMAGES FOR LOSS OF GOODWILL, LOSS OF REVENUE OR PROFIT, WORK STOPPAGE, COMPUTER FAILURE OR MALFUNCTION, FAILURE OF OTHER EQUIPMENT OR COMPUTER PROGRAMS TO WHICH D-LINK'S PRODUCT IS CONNECTED WITH, LOSS OF INFORMATION OR DATA CONTAINED IN, STORED ON, OR INTEGRATED WITH ANY PRODUCT RETURNED TO D-LINK FOR WARRANTY SERVICE) RESULTING FROM THE USE OF THE PRODUCT, RELATING TO WARRANTY SERVICE, OR ARISING OUT OF ANY BREACH OF THIS LIMITED WARRANTY, EVEN IF D-LINK HAS BEEN ADVISED OF THE POSSIBILITY OF SUCH DAMAGES. THE SOLE REMEDY FOR A BREACH OF THE FOREGOING LIMITED WARRANTY IS REPAIR, REPLACEMENT OR REFUND OF THE DEFECTIVE OR NONCONFORMING PRODUCT. THE MAXIMUM LIABILITY OF D-LINK UNDER THIS WARRANTY IS LIMITED TO THE PURCHASE PRICE OF THE PRODUCT COVERED BY THE WARRANTY. THE FOREGOING EXPRESS WRITTEN WARRANTIES AND REMEDIES ARE EXCLUSIVE AND ARE IN LIEU OF ANY OTHER WARRANTIES OR REMEDIES, EXPRESS, IMPLIED OR STATUTORY.

Governing Law:

This Limited Warranty shall be governed by the laws of the State of California. Some states do not allow exclusion or limitation of incidental or consequential damages, or limitations on how long an implied warranty lasts, so the foregoing limitations and exclusions may not apply. This Limited Warranty provides specific legal rights and you may also have other rights which vary from state to state.

Trademarks:

D-Link is a registered trademark of D-Link Systems, Inc. Other trademarks or registered trademarks are the property of their respective owners.

Copyright Statement:

No part of this publication or documentation accompanying this product may be reproduced in any form or by any means or used to make any derivative such as translation, transformation, or adaptation without permission from D-Link Corporation/D-Link Systems, Inc., as stipulated by the United States Copyright Act of 1976 and any amendments thereto. Contents are subject to change without prior notice.

Copyright 2006 by D-Link Corporation/D-Link Systems, Inc. All rights reserved.

CE Mark Warning:

This is a Class B product. In a domestic environment, this product may cause radio interference, in which case the user may be required to take adequate measures.

FCC Statement:

This equipment has been tested and found to comply with the limits for a Class B digital device, pursuant to part 15 of the FCC Rules. These limits are designed to provide reasonable protection against harmful interference in a residential installation. This equipment generates, uses, and can radiate radio frequency energy and, if not installed and used in accordance with the instructions, may cause harmful interference to radio communication. However, there is no guarantee that interference will not occur in a particular installation. If this equipment does cause harmful interference to radio or television reception, which can be determined by turning the equipment off and on, the user is encouraged to try to correct the interference by one or more of the following measures:

- Reorient or relocate the receiving antenna.
- Increase the separation between the equipment and receiver.
- Connect the equipment into an outlet on a circuit different from that to which the receiver is connected.
- Consult the dealer or an experienced radio/TV technician for help.

For detailed warranty information applicable to products purchased outside the United States, please contact the corresponding local D-Link office.

Registration



Product registration is entirely voluntary and failure to complete or return this form will not diminish your warranty rights.

Version 1.0
May 19, 2006