



User Manual

Wireless N 360° Home Network Camera

DCS-6010L

Preface

D-Link reserves the right to revise this publication and to make changes in the content hereof without obligation to notify any person or organization of such revisions or changes. Information in this document may become obsolete as our services and websites develop and change. Please refer to the www.mydlink.com website for the most current information.

Manual Revisions

Revision	Date	Description
1.00	October 23, 2012	DCS-6010L Revision A1 with firmware version 1.00
1.01	June 6, 2013	DCS-6010L Revision A1 with firmware version 1.01
1.02	October 1, 2013	DCS-6010L Revision A1 with firmware version 1.01

Trademarks

D-Link and the D-Link logo are trademarks or registered trademarks of D-Link Corporation or its subsidiaries in the United States or other countries. All other company or product names mentioned herein are trademarks or registered trademarks of their respective companies.

Copyright © 2013 D-Link Corporation.

All rights reserved. This publication may not be reproduced, in whole or in part, without prior expressed written permission from D-Link Corporation.

Table of Contents

Product Overview.....	4	Image Setup	35
Package Contents.....	4	Audio and Video.....	37
Introduction.....	5	Preset.....	39
System Requirements	5	Motion Detection	41
Features.....	6	Time and Date.....	42
Hardware Overview	7	Event Setup.....	43
Outside	7	SD Card.....	51
Internal Ports.....	8	Advanced.....	52
Installation	9	HTTPS.....	52
Wireless Installation Considerations.....	9	Access List.....	53
Installation Zero Configuration Setup	10	Maintenance.....	54
Camera Installation Wizard	14	Device Management	54
Mac Users.....	15	System	55
Manual Hardware Installation.....	16	Firmware Upgrade.....	56
Focusing the Camera.....	17	Status	57
Mounting the Camera.....	18	Device Info	57
WPS - Push Button Setup.....	19	Logs	58
mydlink.....	20	Help.....	59
Configuration.....	21	Technical Specifications	60
Using the Configuration Interface.....	21		
Live Video	22		
Setup	24		
Setup Wizard	24		
Network Setup.....	30		
Wireless Setup.....	33		
Dynamic DNS	34		

Product Overview

Package Contents



DCS-6010L Wireless N 360° Home Network Camera



CAT5 Ethernet cable



Power adapter



CD-ROM with User Manual and software



Quick Installation Guide



Mounting Bracket



If any of the above items are missing, please contact your reseller.

Note: Using a power supply with a different voltage than the one included with your product will cause damage and void the warranty for this product.

Introduction

Congratulations on your purchase of the DCS-6010L Wireless N 360° Home Network Camera. The DCS-6010L is a versatile and unique solution for your small office or home. Unlike a standard webcam, the DCS-6010L is a complete system with a built-in CPU and web server that transmits high quality video images for security and surveillance. The DCS-6010L can be accessed remotely, and controlled from any PC/Notebook over your local network or through the Internet via a web browser. The simple installation and intuitive web-based interface offers easy integration with your Ethernet/Fast Ethernet or 802.11n/g wireless network. The DCS-6010L also comes with remote monitoring and motion detection features for a complete and cost-effective home security solution.

System Requirements

- Computer with Microsoft Windows® 7/8/Vista/XP, or Mac with OS X 10.6 or higher
- PC with 1.3GHz or above; at least 128MB RAM
- Internet Explorer 7, Firefox 12, Safari 4, or Chrome 20 or higher version with Java installed and enabled
- Existing 10/100 Ethernet-based network or 802.11n wireless network
- A MicroSD memory card (optional) is required for recording to onboard storage. SDHC Class 6 or above is recommended.
- Broadband Internet connection

Features

360 Degree Surveillance

The built-in fisheye lens gives you a full 360 degrees of coverage, allowing it to monitor an entire room with ease. It can also be placed on a wall for 180 degree coverage of a hallway. Distortion correction gives you a panoramic view or a normal corrected image that you can pan across easily.

Simple to Use

The DCS-6010L is a stand-alone system with a built-in CPU, requiring no special hardware or software. The DCS-6010L supports both ActiveX mode for Internet Explorer and Java mode for other browsers such as Firefox® and Safari®.

Supports a Variety of Platforms

Supporting TCP/IP networking, HTTP, and other Internet related protocols. The DCS-6010L can also be integrated easily into other Internet/Intranet applications because of its standards-based features.

802.11n Wireless or Ethernet/Fast Ethernet Support

The DCS-6010L offers wireless 802.11n and Ethernet/Fast Ethernet connectivity, making the DCS-6010L easy to integrate into your existing network environment. The DCS-6010L works with a 10Mbps Ethernet based network or 100Mbps Fast Ethernet based network for traditional wired environments, and works with 802.11n routers or access points for added flexibility. The Site Survey feature also allows you to view and connect to any available wireless networks.

Web Configuration

Using a standard Web browser, administrators can configure and manage the Network Camera directly from its own Web page via Intranet or Internet. This means you can access your DCS-6010L anytime, anywhere in the world.

Broad Range of Applications

With today's high-speed Internet services, the Network Camera can provide the ideal solution for delivering live video images over the Intranet and Internet for remote monitoring. The Network Camera allows remote access using a Web browser for live image viewing, and allows the administrator to manage and control the Network Camera anytime, anywhere in the world. Many applications exist, including industrial and public monitoring of homes, offices, banks, hospitals, child-care centers, and amusement parks.

Remote Monitoring Utility

The D-ViewCam application adds enhanced features and functionality for the Network Camera and allows administrators to configure and access the Network Camera from a remote site via Intranet or Internet. Other features include image monitoring, recording images to a hard drive, viewing up to 32 cameras on one screen, and taking snapshots.

Hardware Overview

Outside



1	Camera Lens	Records video of the surrounding area
2	Camera Cover	Rotate the cover counter-clockwise to remove it and access the Ethernet port and power connector Caution: When removing the cover, remove it slowly to avoid disconnecting the microphone.
3	Microphone	Records audio from the surrounding area
4	MicroSD Card Slot	Insert a MicroSD card for Local storage for storing recorded image and video
5	WPS Status LED	Indicates the WPS connection status of the camera Indicates the camera's current status
6	Status LED	Indicates the camera's current power and connectivity status.
7	WPS Button	Press this button, then press the WPS button for 5 seconds on your router to set up a wireless connection automatically
8	Reset Button	Press and hold this button for 10 seconds to reset the camera

Internal Ports

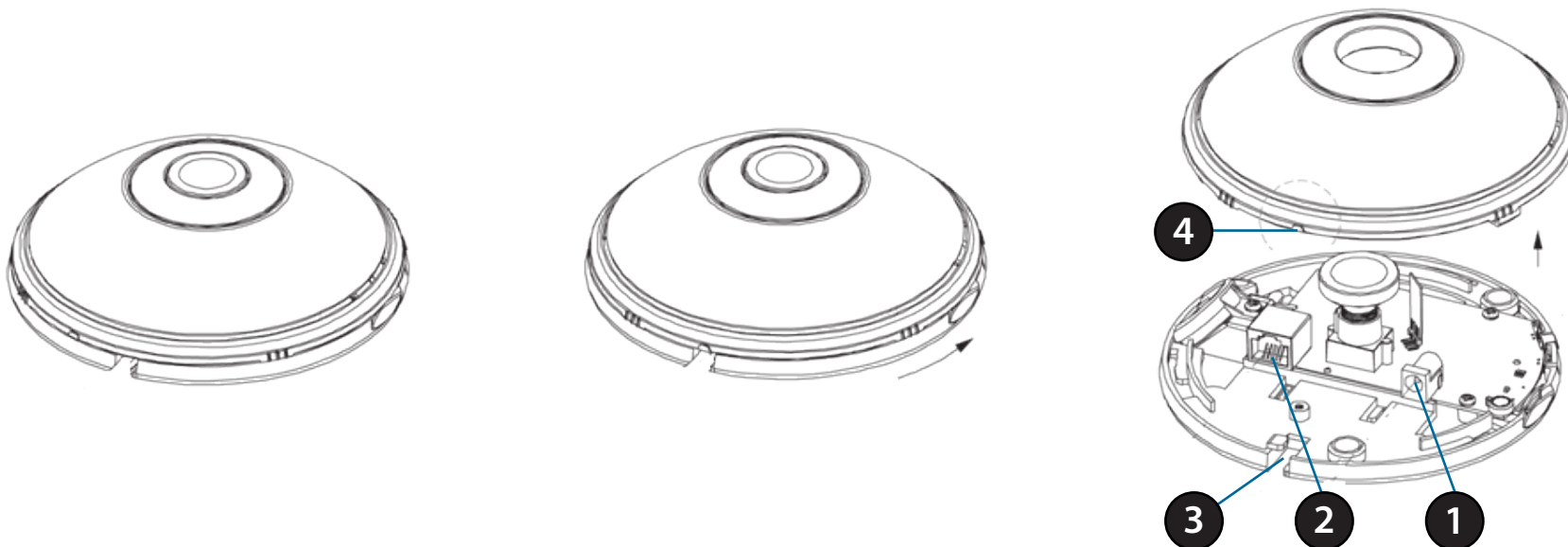

You can access the inside of the DCS-6010L by rotating the camera cover counter-clockwise, then lifting it off of the camera.

Caution: When re-attaching the cover, ensure that the cables are seated in the cable channel.

1	Power Receptor	Power receptor for the provided power cable
2	Ethernet Port	Connects to an RJ45 Ethernet
3	Cable Channel	Channel for Ethernet and Power cables
4	Cable Channel Guide	Guide to assist correct casing alignment with the cable channel.

Installation

Wireless Installation Considerations

This D-Link device can connect to your wireless network from anywhere within the operating range of your wireless network. However, the number, thickness and location of walls, ceilings, or other objects that the wireless signals must pass through, may limit the range. Typical ranges vary depending on the types of materials and background RF (radio frequency) noise in your home or business. The key to maximizing wireless range is to follow these basic guidelines:

1. Minimize the number of walls and ceilings between your adapter and other network devices (such as your Network Camera) - each wall or ceiling can reduce your adapter's range from 3-90 feet (1-30 meters).
2. Be aware of the direct line between network devices. A wall that is 1.5 feet thick (.5 meters), at a 45-degree angle appears to be almost 3 feet (1 meter) thick. At a 2-degree angle, it looks over 42 feet (14 meters) thick. Position your devices so that the signal will travel straight through a wall or ceiling (instead of at an angle) for better reception.
3. Building Materials make a difference. A solid metal door or aluminum studs may weaken the wireless signal. Try to position your access points, wireless routers, and other networking devices where the signal passes through drywall or open doorways. Materials and objects such as glass, steel, metal, walls with insulation, water (fish tanks), mirrors, file cabinets, brick, and concrete will degrade your wireless signal.
4. Keep your product at least 3-6 feet or 1-2 meters away from electrical devices or appliances that generate RF noise.
5. If you are using 2.4GHz cordless phones or other radio frequency sources (such as microwave ovens), your wireless connection may degrade dramatically or drop completely. Make sure your 2.4GHz phone base is as far away from your wireless devices as possible. The base transmits a signal even if the phone is not in use.

Note: The DCS-6010L has a metal underside and mounting bracket.

The metal underside and mounting bracket will affect directional WiFi signal strength adversely if not positioned correctly

Installation Zero Configuration Setup

If you have a mydlink-enabled Cloud Router, you can take advantage of Zero Configuration. Zero Configuration automatically configures your camera's settings for you, and adds it to your mydlink account automatically. This type of setup allows you to set up your camera by simply plugging it in and connecting it to your router.

Connect your camera to your mydlink-enabled Cloud Router and Zero Configuration will automatically configure your DCS-6010L and automatically add the camera to your mydlink account. After the short time it takes to do this you can remotely access your camera from the www.mydlink.com website to manage and monitor your DCS-6010L.

Connect the Ethernet Cable

Using the provided Ethernet cable connect one end to your camera and the other-end to your network.

To install the provided Ethernet cable see "Internal Ports" on page 8 for detailed instructions.

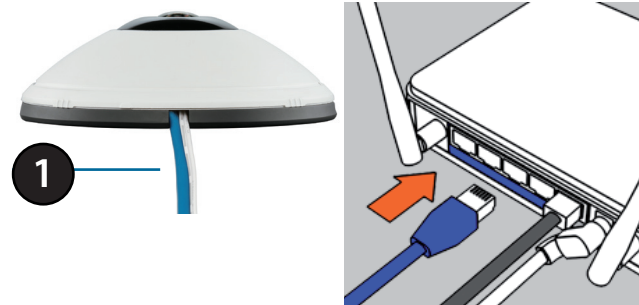

Attach the External Power Supply

Attach the external power supply to the power receptor and to your wall outlet or power strip.

To install the provided power supply see "Internal Ports" on page 8 for detailed instructions.

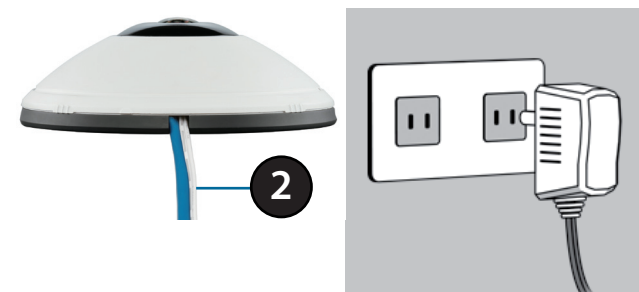

1	Ethernet Cable	Use an RJ45 Ethernet cable to connect to your network
2	Power Cable	Power cable for the provided power adapter

Optional: WPS Wireless Connection

Alternatively, if your router supports WPS, you can use the WPS button on the camera to easily create a secure wireless connection to your network.

To create a WPS connection:

Step 1

Press and hold the WPS button for approximately 5-6 seconds. The WPS LED will blink.

Step 2

Within 60 seconds press the WPS button on your router. On some routers, you may need to log in to the web interface and click on an on-screen button to activate the WPS feature. If you are not sure where the WPS button is on your router, please refer to your router's User Manual.

The DCS-6010L will automatically create a wireless connection to your router. While connecting, the status LED will flash. When the connection process is complete, the status LED will turn solid.

You can now remove the Ethernet cable by removing the camera cover and disconnecting the Ethernet cable. See "Internal Ports" on page 8 for more details.

Note: If your router does not support WPS, you can still use the wired connection method on the previous page. After Zero Configuration setup is complete, your router's wireless settings will be automatically transferred to the camera.

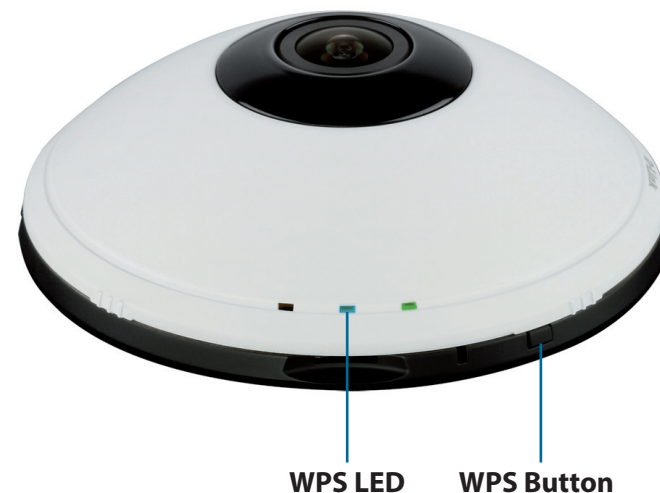

Check Your mydlink Account

From any computer, open a web browser, go to <http://www.mydlink.com> and log into your account. Once mydlink detects your camera, a **New Device Found!** notice will appear in the bottom-left corner. Click on the device name to continue.

The screenshot shows the mydlink web interface. At the top, there's a navigation bar with 'My Devices', 'Shared Devices', 'My Services', and 'My Profile'. The main content area is titled 'Router Status' and 'Settings'. It displays the following information:

- Model Name: DIR-605L
- Network Name (SSID): Taonet
- Internet IP: 192.168.1.103
- LAN IP: 192.168.0.1
- Connected Devices: 5 device(s)

Below this, there is a 'Connection List' table:

Device	Device Name	IP Address	MAC Address	Block
	CardboardBox	192.168.0.110	00:26:2D:02:FE:FA	<input type="checkbox"/>
	--	192.168.0.120	04:54:53:50:53:18	<input type="checkbox"/>
	HeGuy	192.168.0.100	00:1A:92:E2:4D:C9	<input type="checkbox"/>
	--	192.168.0.121	28:E0:2C:DC:0A:BE	<input type="checkbox"/>
	--	192.168.0.101	F0:A2:25:AA:8C:C3	<input type="checkbox"/>

At the bottom left, a 'New Device Found!' notification is visible, listing 'DCS-6010L'.

A summary and confirmation notification will appear with the automatically configured details. Make a note of the details and click **OK** to add the camera to your account.

The screenshot shows a dialog box titled 'Confirming New Device'. It contains the following text:

Do you want to add this new device to your mydlink account?

Device Name: DCS-6010L
mydlink Number: 44441252
Network name (SSID): dddddd
Admin Password: oic953XZ

You can change these default settings by going to **Advanced Settings** after add it to your device list.

At the bottom, there are two buttons: 'Not now' and 'Yes'.

Zero Configuration is now complete and your camera has been added to your mydlink account. You can now view your camera on the mydlink Live View tab.

If you wish to connect your camera to your router wirelessly, you can simply disconnect the Ethernet cable and move the camera to its intended location; your router's wireless settings have been automatically transferred to the camera, and no further configuration is required.

Your camera is now set up, and you can skip to "mydlink" on page 20 to learn more about the mydlink features of this camera, or to "Configuration" on page 21 for advanced configuration of your camera.

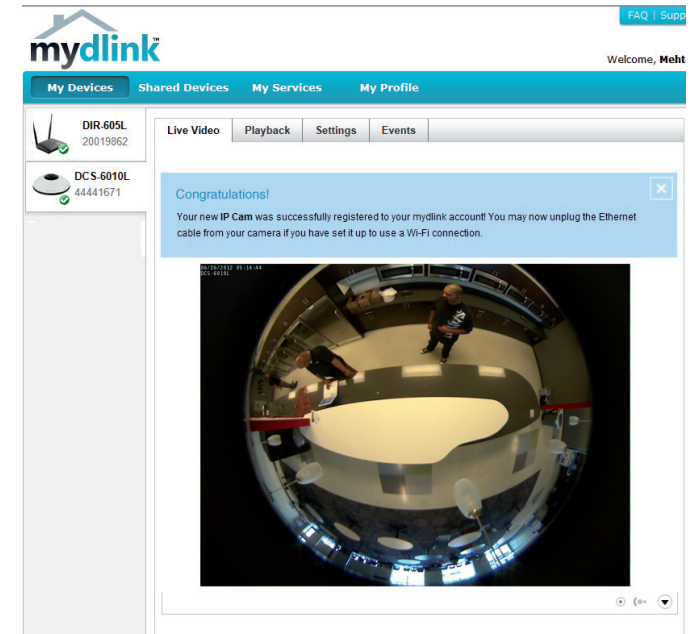

Camera Installation Wizard Windows Users

Insert the Installation CD-ROM into your computer's optical drive to start the autorun program.

Simply click Set up your Cloud Camera to go through the Setup Wizard, which will guide you step-by-step through the installation process from connecting your hardware to configuring your camera and registering it with your mydlink account.



Note: If the autorun program does not open, go to My Computer, browse to your CD drive, and double-click on the autorun.exe file.

Mac Users

Insert the Installation CD-ROM into your computer's CD drive. On the desktop, open your CD drive and double-click on the **SetupWizard** file.



Within 20-30 seconds, the Setup Wizard will open, which will guide you step-by-step through the installation process from connecting your hardware to configuring your camera and registering it with your mydlink account.

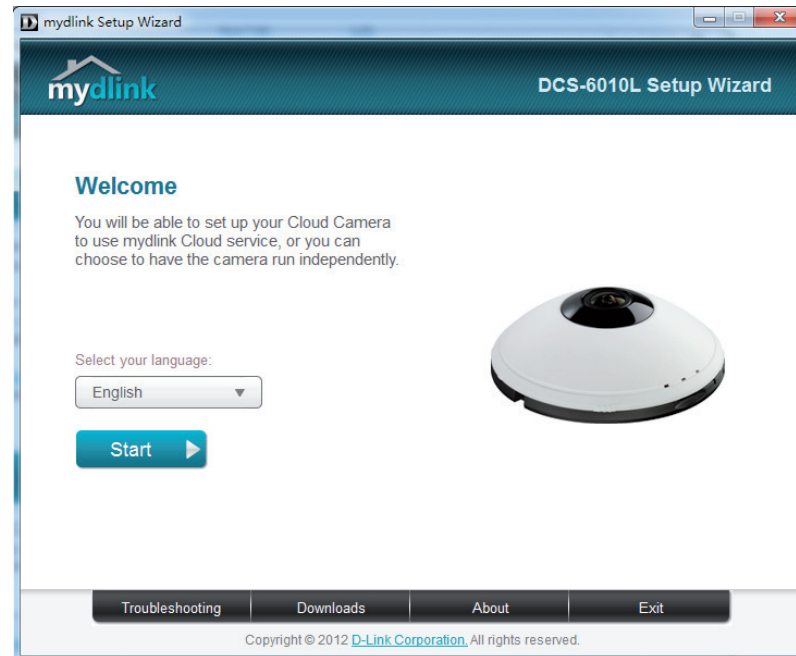

Note: mydlink portal requires Java™ to function correctly.

For more guidelines, please refer to mydlink FAQ pages at <https://eu.mydlink.com/faq/mydlink>

Manual Hardware Installation

If you wish to set up your camera without using the Camera Setup Wizard, please follow these steps.

Note: In order to use the mydlink features of this product, you will need to go through the Camera Setup Wizard.

Connect the Ethernet Cable

Using the provided Ethernet cable connect one end to your camera and the other-end to your network.

To install the provided Ethernet cable see "Internal Ports" on page 8 for detailed instructions.

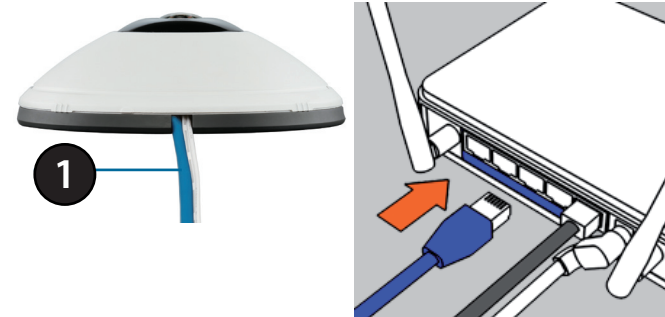

Attach the External Power Supply

Attach the external power supply to the power receptor and to your wall outlet or power strip.

To install the provided power supply see "Internal Ports" on page 8 for detailed instructions.

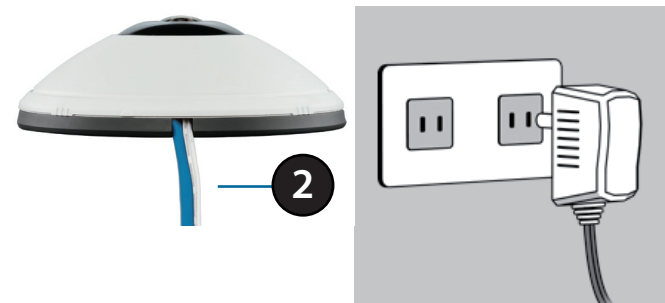

1	Ethernet Cable	Use an RJ45 Ethernet cable to connect to your network
2	Power Cable	Power cable for the provided power adapter

Focusing the Camera

The DCS-6010L can be focused by adjusting the lens.

Step 1

Place the camera on a non-slip surface.

Step 2

Remove the cover by following the steps outlined in "Internal Ports" on page 8.

Step 3

Adjust the focus by rotating the lens in a clockwise or counter clockwise direction until satisfied.

Step 4

Ensure the cables are seated in the cable channel.

Step 5

Seat the cover and rotate to align the cable channel guide over the cable channel.

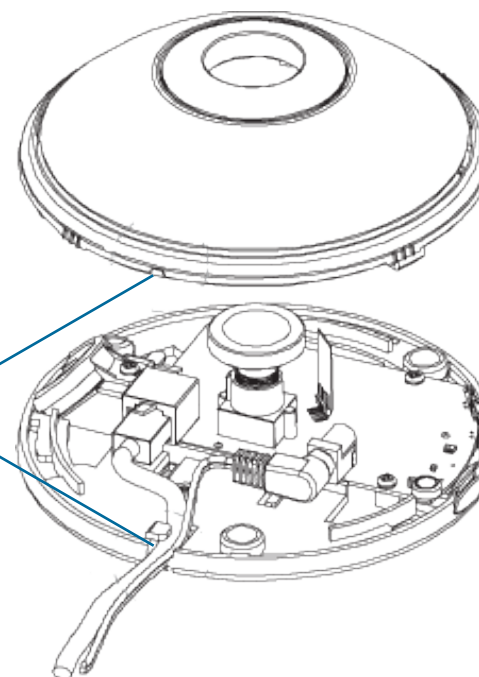
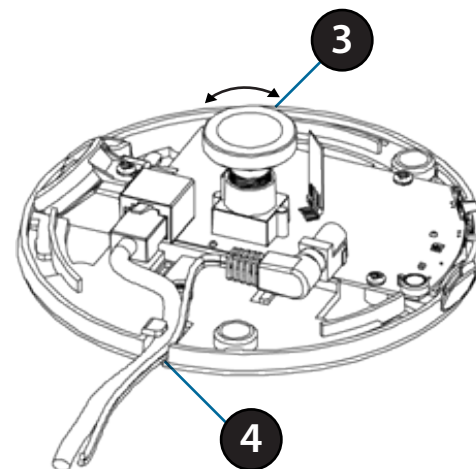

Mounting the Camera

The DCS-6010L is suitable for mounting to a ceiling, wall or desktop using the bracket provided.

Note: In order to use the mydlink features of this product, you will need to go through the Camera Setup Wizard.

Step 1

Unclip the wall bracket from the DCS-6010L by sliding the base down.

Step 2

Position the mounting bracket in the desired location and mark the surface behind it holes using the bracket as a stencil / in pencil

Step 3

Use a 6mm drill bit to make required holes approximately 25mm deep.

Step 4

Insert wall anchors.

Step 5

Affix bracket using the screws provided.

Step 6

Clip the DCS-6010L to the bracket ensuring a tight fit

Note: if mounting on a wall ensure the camera is oriented with the cables positioned to the bottom of the device.

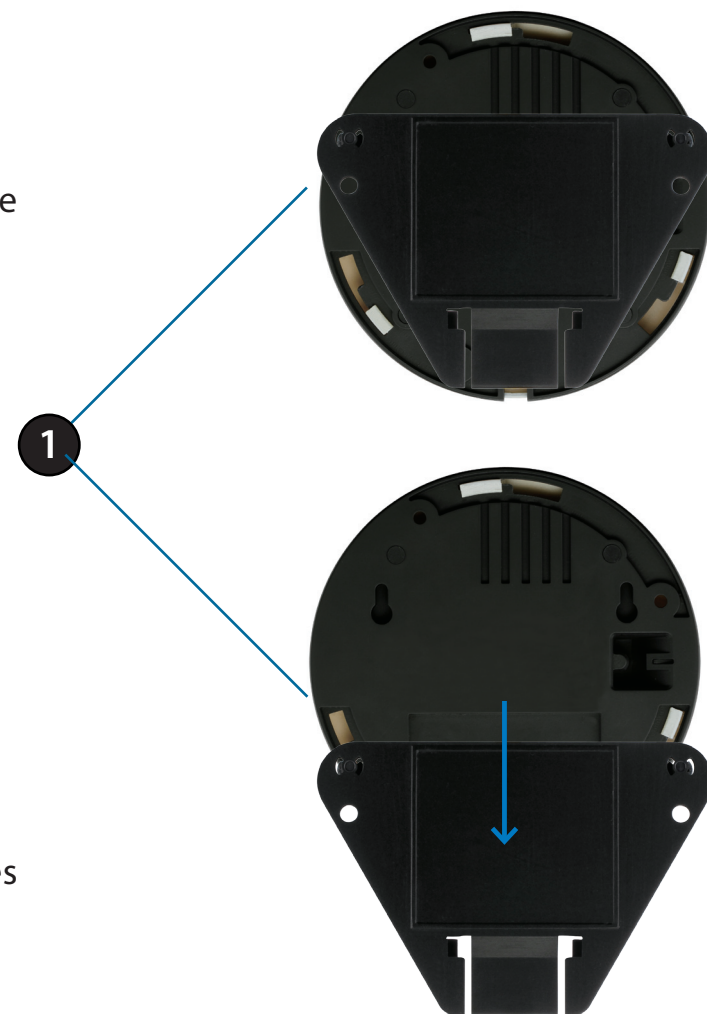

WPS - Push Button Setup

If your router supports WPS, you can use the WPS button on the camera to easily create a secure wireless connection to your network.

To create a WPS connection:

Step 1

Press and hold the WPS button for approximately 5-6 seconds. The WPS LED will blink.

Step 2

Within 60 seconds press the WPS button on your router. On some routers, you may need to log in to the web interface and click on an on-screen button to activate the WPS feature. If you are not sure where the WPS button is on your router, please refer to your router's User Manual.

The DCS-6010L will automatically create a wireless connection to your router. While connecting, the status LED will flash. When the connection process is complete, the status LED will turn solid.

Note: If your router does not support WPS, you can still use the wired connection method on the previous page.

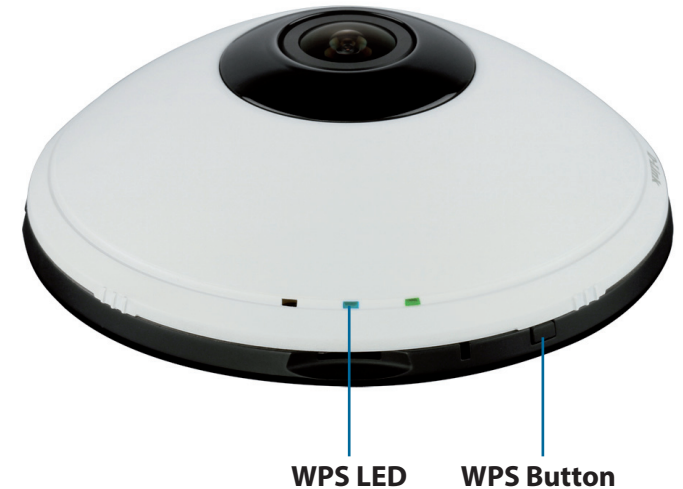

mydlink

After registering your DCS-6010L camera with a mydlink account in the Camera Installation Wizard, you will be able to remotely access your camera from the www.mydlink.com website. After signing in to your mydlink account, you will see a screen similar to the following:

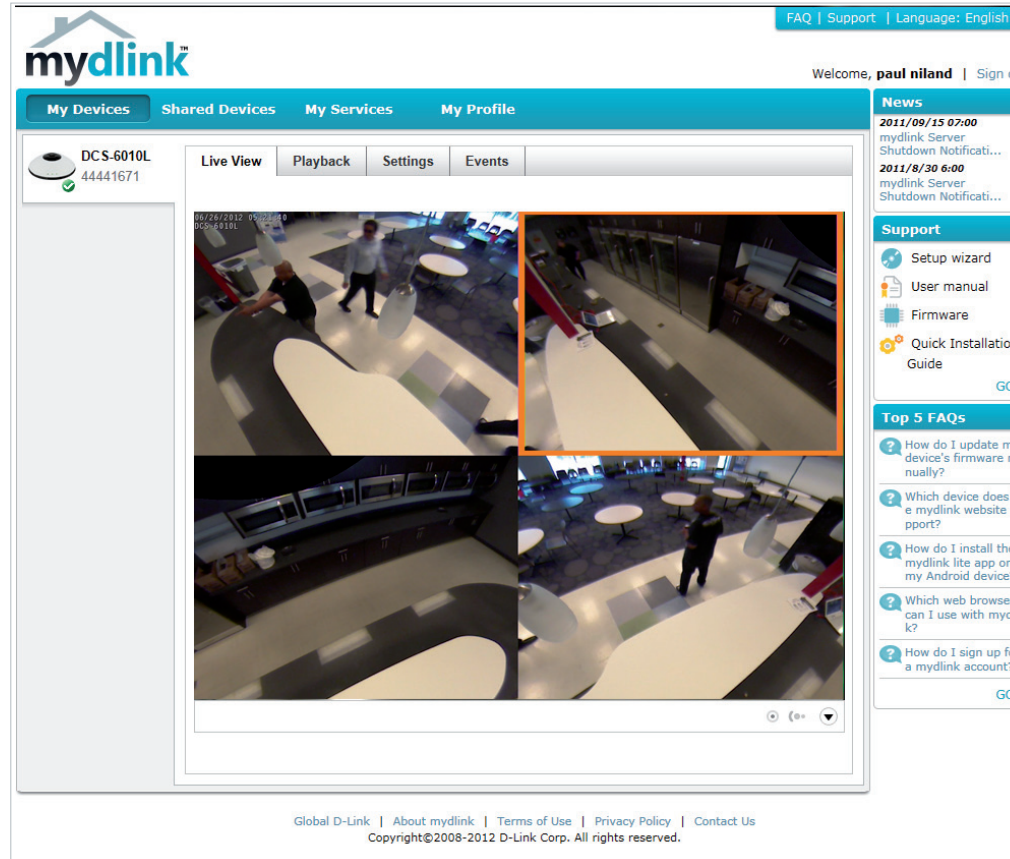

For more details on using your camera with mydlink, go to the **Support** section of the mydlink website and check the **User Manual** section for your product to find the latest instruction guide for your camera's mydlink features.

Configuration

Using the Configuration Interface

After completing the Camera Installation Wizard, you are ready to use your camera. The camera's built-in Web configuration utility is designed to allow you to easily access and configure your DCS-6010L. At the end of the wizard, enter the IP address of your camera into a web browser, such as Mozilla Firefox. To log in, use the User name **admin** and the password you created in the Installation Wizard. If you did not create a password, the default password is blank. After entering your password, click **OK**.

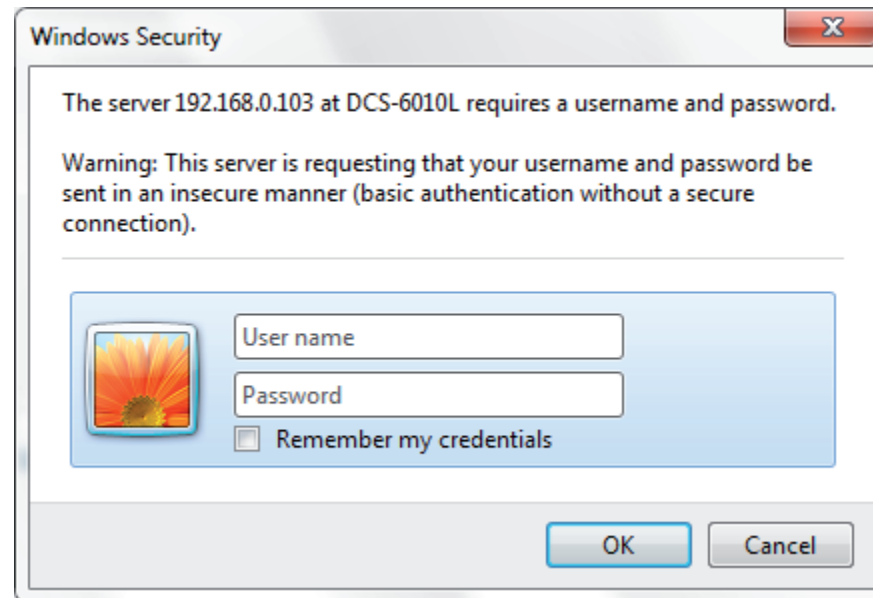







Live Video









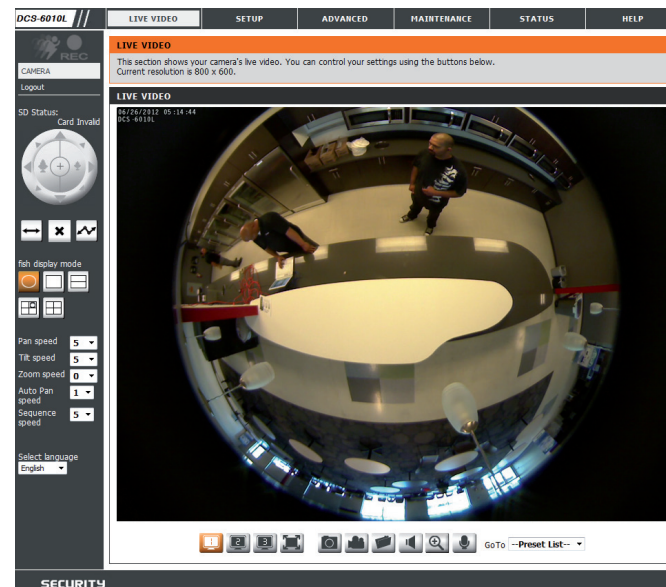

This section shows your camera's live video. You may select any of the available icons listed below to operate the camera. You may also select your language using the drop-down menu on the left side of the screen.

You can zoom in and out on the live video image using your mouse. Right-click to zoom out or left-click to zoom in on the image.

SD Status: This option displays the status of the SD card. If no SD card has been inserted, this screen will display the message "Card Invalid."

	Motion Trigger Indicator	This indicator will change color when a trigger event occurs. Note: The video motion feature for your camera must be enabled.
	Recording Indicator	When a recording is in progress, this indicator will change color.
	Control Pad	This control pad can be used to electronically pan, tilt, and zoom (ePTZ) within the camera's predefined view area, if one has been defined.
	Auto Pan	Click this button to start the automated circular rotation through a regional view (360* continuous rotation). Note: This function does not apply in a Panoramic view because a panoramic view already shows the full coverage.
	Stop	Click this button to stop the Auto Pan and Auto Rotate functions.
	Preset Path	Once you have determined a list of preset PTZ positions, click this button to consecutively display views of these positions. The DCS-6010L will display these views continuously. For more information please refer to "Preset" on page 39









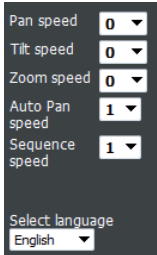

Display mode	Display Mode	Here, you can select between the different display modes:
		 Fisheye Mode: shows the full camera view
		 Normal Mode: shows a corrected view similar to a standard camera view that you can move using the control pad.
		 Panoramic Mode: This shows a corrected, full 180 view across 2 video panels.
		 Multi-View with Fisheye: This shows a multiple window view, with a full Fisheye view in the top-right panel.
		 Multi-View: This shows a multiple window view.



Pan/Tilt/Zoom/ You can set the speed of pan/tilt/zoom/panoramic/sequence **Panoramic/** movement by using the dropdown menus. **Sequence** **Speed:**



Language: You may select the interface language using this menu.

- | | |
|--|--|
|  Video Profile 1 |  Record a Video Clip |
|  Video Profile 2 |  Set a Storage Folder |
|  Video Profile 3 |  Listen/Stop Audio In (from microphone) |
|  Full screen mode |  Start/Stop Audio Out (to speaker) |
|  Take a Snapshot | |

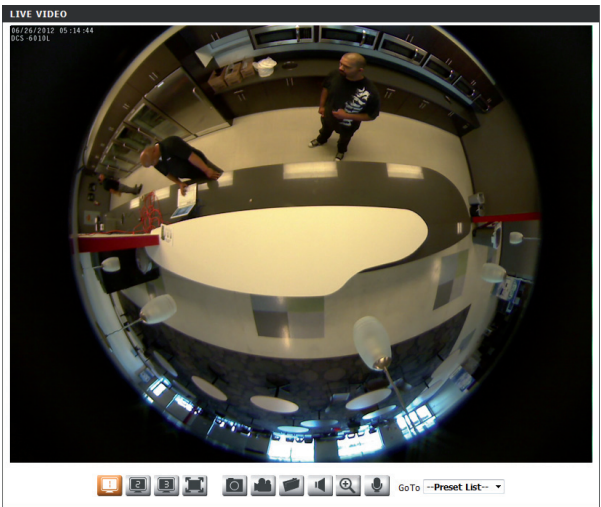

Go To: If any presets have been defined, selecting a preset from this list will **(Preset List)** display it.

Setup Setup Wizard

To configure your Network Camera, click **Internet Connection Setup Wizard**. Alternatively, you may click **Manual Internet Connection Setup** to manually configure your Network Camera and skip to "Network Setup" on page 30.

To quickly configure your Network Camera's motion detection settings, click **Motion Detection Setup Wizard**. If you want to enter your settings without running the wizard, click **Manual Motion Detection Setup** and skip to "Motion Detection" on page 41.

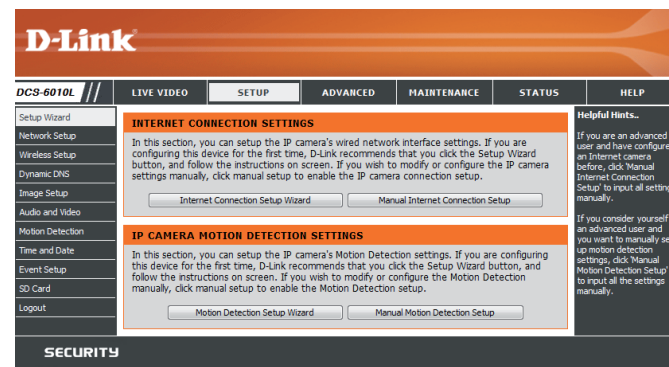

Internet Connection Setup Wizard

This wizard will guide you through a step-by-step process to configure your new D-Link Camera and connect the camera to the internet. Click **Next** to continue.

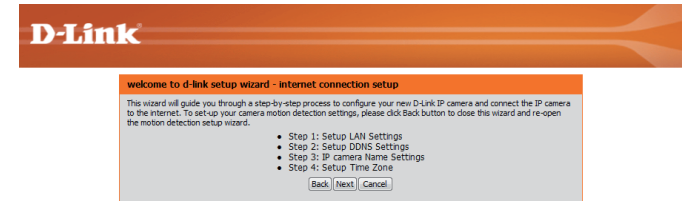

Note: Select DHCP if you are unsure of which settings to choose.

Click **Next** to continue.

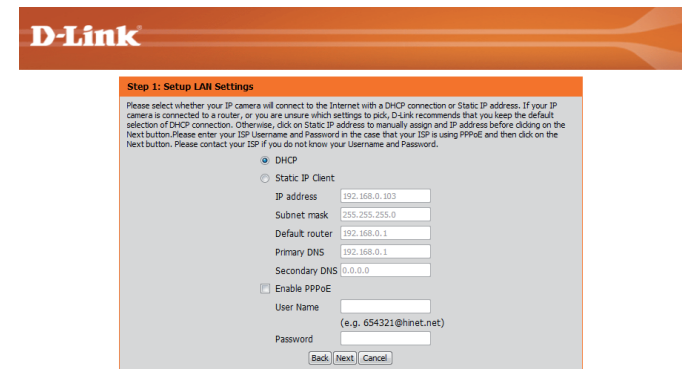

Select **Static IP** if your Internet Service Provider has provided you with connection settings, or if you wish to set a static address within your home network. Enter the correct configuration information and click **Next** to continue.

If you are using PPPoE, select **Enable PPPoE** and enter your user name and password, otherwise click **Next** to continue.

If you have a Dynamic DNS account and would like the camera to update your IP address automatically, Select **Enable DDNS** and enter your host information. Click **Next** to continue.

Enter a name for your camera and click **Next** to continue.

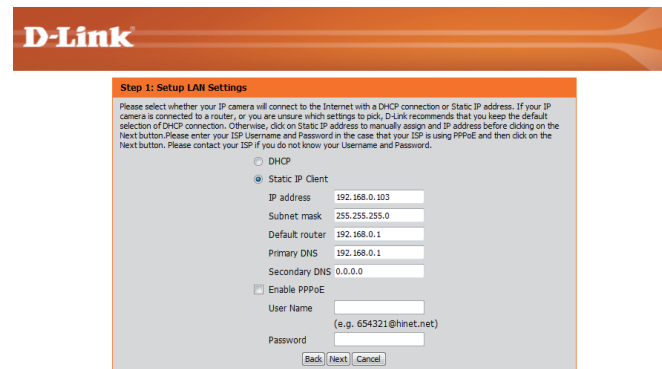

D-Link

Step 1: Setup LAN Settings

Please select whether your IP camera will connect to the Internet with a DHCP connection or Static IP address. If your IP camera is connected to a router, or you are unsure which settings to pick, D-Link recommends that you keep the default selection of DHCP connection. Otherwise, click on Static IP address to manually assign an IP address before clicking on the Next button. Please enter your ISP Username and Password in the case that your ISP is using PPPoE and then click on the Next button. Please contact your ISP if you do not know your Username and Password.

DHCP

Static IP Client

IP address 192.168.0.103

Subnet mask 255.255.255.0

Default router 192.168.0.1

Primary DNS 192.168.0.1

Secondary DNS 0.0.0.0

Enable PPPoE

User Name _____
(e.g. 654321@hinet.net)

Password _____

Back Next Cancel

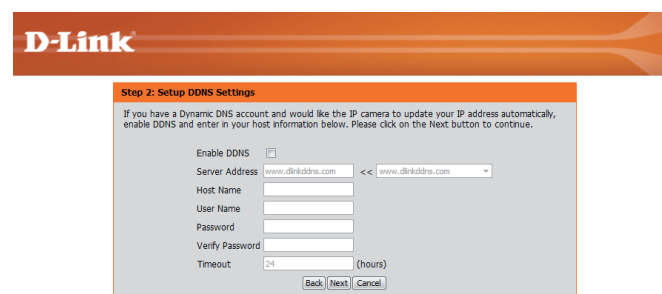

D-Link

Step 2: Setup DDNS Settings

If you have a Dynamic DNS account and would like the IP camera to update your IP address automatically, enable DDNS and enter in your host information below. Please click on the Next button to continue.

Enable DDNS

Server Address www.dlinkddns.com << www.dlinkddns.com

Host Name _____

User Name _____

Password _____

Verify Password _____

Timeout 24 (hours)

Back Next Cancel



D-Link

Step 3: IP camera Name Settings

D-Link recommends that you rename your IP camera for easy accessibility. You can then identify and connect to your IP camera via this name. Please assign a name of your choice before clicking on the Next button.

IP camera Name DCS-6010L

Back Next Cancel

Configure the correct time to ensure that all events will be triggered as scheduled. Click **Next** to continue.

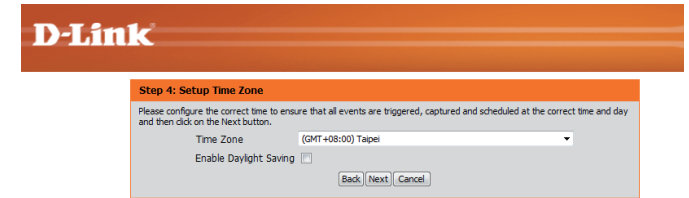

Confirm the settings are correct and click **Apply** to save them..

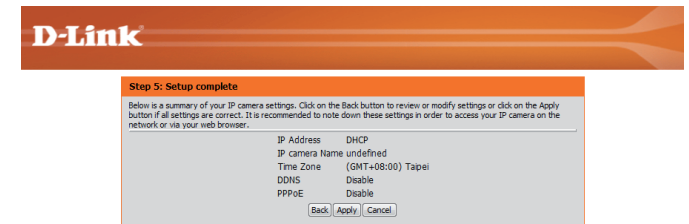

The settings will be saved to the DCS-6010L and the camera will restart.

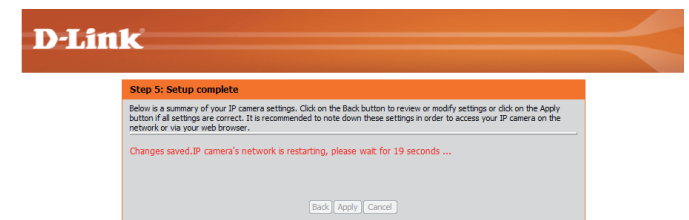

Motion Detection Setup Wizard

This wizard will guide you through a step-by-step process to configure your camera's motion detection functions.

Click **Next** to continue.

Step 1

This step will allow you to enable or disable motion detection, specify the detection sensitivity, and adjust the camera's ability to detect movement.

You may specify whether the camera should capture a snapshot or a video clip when motion is detected.

Please see the **Motion Detection** section on "Motion Detection" on page 41 for information about how to configure motion detection.

Step 2

This step allows you to enable motion detection based on a customized schedule. Specify the day and hours. You may also choose to always record whenever motion is detected.

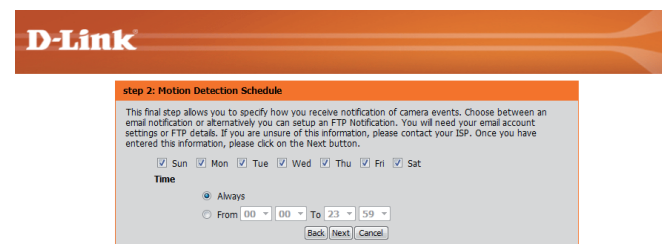
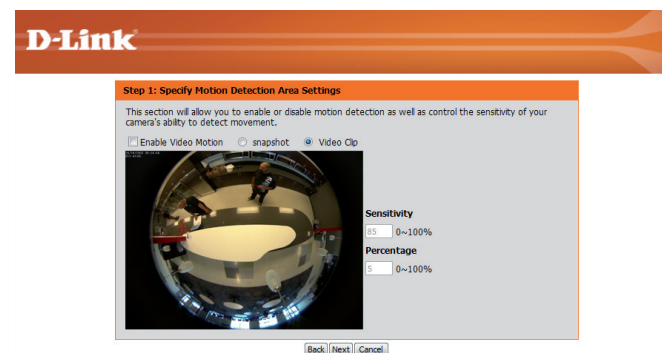
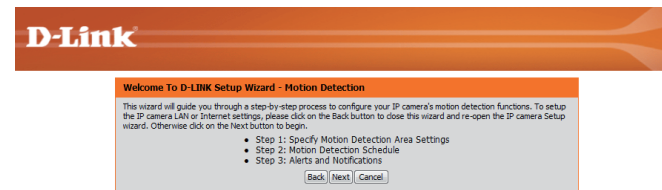

Step 3

This step allows you to specify how you will receive event notifications from your camera. You may choose not to receive notifications, or to receive notifications via e-mail or FTP.

Please enter the relevant information for your e-mail or FTP account.

Click **Next** to continue.

The screenshot shows the 'Step 3: Alerts and Notification' configuration screen. It features a D-Link logo at the top. Below the title, there is a paragraph of instructions: 'This final step allows you to specify how you receive notification of camera events. Choose between an email notification or alternatively you can setup an FTP Notification. You will need your email account settings or FTP details. If you are unsure of this information, please contact your ISP. Once you have entered this information, please click on the Next button.' There are two radio button options: 'Do not notify me' (unselected) and 'Email' (selected). Under the 'Email' option, there are input fields for 'Sender email address', 'Recipient email address', 'Server address', 'User name', 'Password', and 'Port' (with '25' entered). Under the 'FTP' option, there are input fields for 'Server address', 'Port' (with '21' entered), 'User name', 'Password', and 'Remote folder name'. At the bottom right, there are 'Back', 'Next', and 'Cancel' buttons.

Step 4

You have completed the Motion Detection Wizard.

Please verify your settings and click **Apply** to save them.

The screenshot shows the 'Step 4: Setup Complete' screen. It features a D-Link logo at the top. Below the title, there is a paragraph of instructions: 'You have completed your IP camera setup. Please click the Back button if you want to review or modify your settings or click on the Apply button to save and apply your settings.' Below this, the following settings are listed: 'Motion Detection : Enable', 'EVENT : Video Clip', 'Schedule Day : Sun , Mon , Tue , Wed , Thu , Fri , Sat ,', 'Schedule Time : Always', and 'Alerts and Notification : Email'. At the bottom right, there are 'Back', 'Apply', and 'Cancel' buttons.

Please wait a few moments while the camera saves your settings and restarts.

The screenshot shows the 'Step 4: Setup Complete' screen, identical to the previous one, but with an additional red message: 'Changes saved. IP camera's network is restarting, please wait for 6 seconds ...'. At the bottom right, there are 'Back', 'Apply', and 'Cancel' buttons.

Network Setup

Use this section to configure the network connections for your camera. All relevant information must be entered accurately. After making any changes, click the **Save Settings** button to save your changes.

LAN Settings: This section lets you configure settings for your local area network.

DHCP: Select this connection if you have a DHCP server running on your network and would like your camera to obtain an IP address automatically.

If you choose DHCP, you do not need to fill out the IP address settings.

Static IP Client: You may obtain a static or fixed IP address and other network information from your network administrator for your camera. A static IP address may simplify access to your camera in the future.

IP Address: Enter the fixed IP address in this field.

Subnet Mask: This number is used to determine if the destination is in the same subnet. The default value is 255.255.255.0.

Default Gateway: The gateway used to forward frames to destinations in a different subnet. Invalid gateway settings may cause the failure of transmissions to a different subnet.

Primary DNS: The primary domain name server translates names to IP addresses.

Secondary DNS: The secondary DNS acts as a backup to the primary DNS.

D-Link

DCS-6010L // LIVE VIDEO SETUP ADVANCED MAINTENANCE STATUS HELP

NETWORK SETUP
You can configure your LAN and Internet settings here.
Save Settings Don't Save Settings

LAN SETTINGS

DHCP

Static IP Client

IP address: 192.168.0.103
Subnet mask: 255.255.255.0
Default router: 192.168.0.1
Primary DNS: 192.168.0.1
Secondary DNS: 0.0.0.0

Enable UPnP presentation
 Enable UPnP port forwarding
Forwarding Port: 1024 (Text)
Forwarding Status: UPnP forwarding is inactive

PPPoE SETTINGS

Enable Disable
User Name:
Password:
Confirm password:
PPPoE Status: PPPoE is inactive.

HTTP

HTTP port: 80
Access name for stream1: video1.mjpg
Access name for stream2: video2.mjpg
Access name for stream3: video3.mjpg

HTTPS

HTTPS port: 443

RTSP

Authentication: Disable
RTSP port: 554
Access name for stream1: live1.sdp
Access name for stream2: live2.sdp
Access name for stream3: live3.sdp

CoS SETTINGS

Enable CoS
VLAN ID: 1 [0-4095]
Live video: 0
Live audio: 0
Event/Alarm: 0
Management: 0

QoS SETTINGS

Enable QoS
Live video: 0
Live audio: 0
Event/Alarm: 0
Management: 0

IPV6

Enable IPv6

Helpful Hints..

Select DHCP Connection if you are running a DHCP server on your network and would like an IP address assigned to your IP camera automatically.

UPnP: Enabling UPnP settings will allow you to configure your IP camera as an UPnP device in the network.

PPPoE Setting: If you use the IP camera to connect directly to the Internet, you will need to enter the username and password, which were given to you when you set up your account with your Internet Service Provider. If the camera is behind a router or a gateway, you do not need to configure this setting.

HTTP: HTTP Port is the port you allocate in order to connect to the IP camera via a standard web browser.

HTTPS: HTTPS Port in a IP camera connects it with a PC via a secure web browser.

RTSP: RTSP Port is the port you allocate in order to connect to a IP camera by using streaming mobile device(s), such as a mobile phone or PDA.

CoS (Class of Service): Coarsely-grained traffic control based on the L2 protocol. Class of Service technologies do not guarantee a level of service in terms of bandwidth and delivery time, they offer a "best-effort".

QoS (Quality of Service): Finely-grained traffic control, a resource reservation control mechanism. Quality of service guarantees are important if the network capacity is insufficient, especially for real-time streaming multimedia applications.

Enable UPnP Presentation: Enabling this setting allows your camera to be configured as a UPnP device on your network.

Enable UPnP Port Forwarding: Enabling this setting allows the camera to add port forwarding entries into the router automatically on a UPnP capable network.

Enable PPPoE: Enable this setting if your network uses PPPoE.

User Name / Password: Enter the username and password for your PPPoE account. Re-enter your password in the Confirm Password field. You may obtain this information from your ISP.

HTTP Port: The default port number is 80.

Access Name for Stream 1~3: The default name is video#.mjpg, where # is the number of the stream.

HTTPS Port: You may use a PC with a secure browser to connect to the HTTPS port of the camera. The default port number is 443.

RTSP Port: The port number that you use for RTSP streaming to mobile devices, such as mobile phones or PDAs. The default port number is 554. You may specify the address of a particular stream. For instance, live1.sdp can be accessed at rtsp://x.x.x.x/video1.sdp where the x.x.x.x represents the ip address of your camera.

LAN SETTINGS	
<input checked="" type="radio"/> DHCP	
<input type="radio"/> Static IP Client	
IP address	192.168.0.103
Subnet mask	255.255.255.0
Default router	192.168.0.1
Primary DNS	192.168.0.1
Secondary DNS	0.0.0.0
<input checked="" type="checkbox"/> Enable UPnP presentation	
<input type="checkbox"/> Enable UPnP port forwarding	
Forwarding Port	1024 <input type="button" value="Test"/>
Forwarding Status	UPnP forwarding is inactive
PPPOE SETTINGS	
<input type="radio"/> Enable <input checked="" type="radio"/> Disable	
User Name	<input type="text"/>
Password	<input type="text"/>
Confirm password	<input type="text"/>
PPPoE Status	PPPoE is inactive.
HTTP	
HTTP port	80
Access name for stream1	video1.mjpg
Access name for stream2	video2.mjpg
Access name for stream3	video3.mjpg
HTTPS	
HTTPS port	443
RTSP	
Authentication	Disable ▾
RTSP port	554
Access name for stream1	live1.sdp
Access name for stream2	live2.sdp
Access name for stream3	live3.sdp

Enable CoS: Enabling the Class of Service setting implements a best-effort policy without making any bandwidth reservations.

Enable QoS: Enabling QoS allows you to specify a traffic priority policy to ensure a consistent Quality of Service during busy periods. If the Network Camera is connected to a router that itself implements QoS, the router's settings will override the QoS settings of the camera.

Enable IPV6: Enable the IPV6 setting to use the IPV6 protocol. Enabling the option allows you to manually set up the address, specify an optional IP address, specify an optional router and an optional primary DNS.

Enable Multicast for stream The DCS-6010L allows you to multicast each of the available streams via group address and specify the TTL value for each stream. Enter the port and TTL settings you wish to use if you do not want to use the defaults.

COS SETTINGS

Enable CoS
 VLAN ID [0~4095]
 Live video
 Live audio
 Event/Alarm
 Management

QOS SETTINGS

Enable QoS
 Live video
 Live audio
 Event/Alarm
 Management

IPV6

Enable IPv6

 Manually setup the IP address
 Optional IP address / Prefix length /
 Optional default router
 Optional primary DNS

MULTICAST

Enable multicast for stream 1
 Multicast group address
 Multicast video port
 Multicast RTCP video port
 Multicast audio port
 Multicast RTCP audio port
 Multicast TTL [1~255]
 Enable multicast for stream 2
 Multicast group address
 Multicast video port
 Multicast RTCP video port
 Multicast audio port
 Multicast RTCP audio port
 Multicast TTL [1~255]
 Enable multicast for stream 3
 Multicast group address
 Multicast video port
 Multicast RTCP video port
 Multicast audio port
 Multicast RTCP audio port
 Multicast TTL [1~255]

Wireless Setup

This section allows you to set up and configure the wireless settings on your camera. After making any changes, click the **Save Settings** button to save your changes.

Site Survey: Click the **Rescan** button to scan for available wireless networks. After scanning, you can use the drop-down box to select an available wireless network. The related information (SSID, Wireless Mode, Channel, Authentication, Encryption) will be automatically filled in for you.

SSID: Enter the SSID of the wireless access point you wish to use.

Wireless Mode: Use the drop-down box to select the mode of the wireless network you wish to connect to. Infrastructure is normally used to connect to an access point or router. Ad-Hoc is usually used to connect directly to another computer.

Channel: If you are using Ad Hoc mode, select the channel of the wireless network you wish to connect to, or select Auto.

Authentication: Select the authentication you use on your wireless network - Open, Shared, WPA-PSK, or WPA2-PSK.

Encryption: If you use WPA-PSK or WPA2-PSK authentication, you will need to specify whether your wireless network uses TKIP or AES encryption. If you use Open or Shared authentication, WEP encryption should be the setting.

Key: If you use WEP, WPA-PSK, or WPA2-PSK authentication, enter the Key (also known as password) used for your wireless network.

The screenshot shows the D-Link DCS-6010L web interface. The main navigation bar includes 'LIVE VIDEO', 'SETUP', 'ADVANCED', 'MAINTENANCE', 'STATUS', and 'HELP'. The 'SETUP' menu is expanded to show 'Setup Wizard', 'Network Setup', 'Wireless Setup', 'Dynamic DNS', 'Image Setup', 'Audio and Video', 'Motion Detection', 'Time and Date', 'Event Setup', 'SD Card', and 'Logout'. The 'Wireless Setup' page is active, displaying the 'WIRELESS CONFIGURATION' section. It includes a 'WIRELESS SETUP' header with a 'Rescan' button and 'Save Settings'/'Don't Save Settings' buttons. The configuration fields are: 'Enable Wireless' (checkbox), 'Site Survey' (SSID List dropdown with Rescan button), 'SSID' (text field), 'Wireless Mode' (Infrastructure dropdown), 'Channel' (Auto dropdown), 'Authentication' (Open dropdown), 'Encryption' (Disable dropdown), 'Default Key' (1 dropdown), and four 'Key' input fields (Key 1-4). A note indicates '(5 or 13 ASCII, 10 or 26 HEX characters)'. 'Save Settings' and 'Don't Save Settings' buttons are at the bottom. A 'Helpful hints...' sidebar on the right provides additional information about SSID, Authentication, Shared, and WPA-PSK/WPA2-PSK.

Dynamic DNS

DDNS (Dynamic Domain Name Server) will hold a DNS host name and synchronize the public IP address of the modem when it has been modified. A user name and password are required when using the DDNS service. After making any changes, click the **Save Settings** button to save your changes.

Enable DDNS: Select this checkbox to enable the DDNS function.

Server Address: Select your Dynamic DNS provider from the pull down menu or enter the server address manually.

Host Name: Enter the host name of the DDNS server.

User Name: Enter the user name or e-mail used to connect to your DDNS account.

Password: Enter the password used to connect to your DDNS server account.

Timeout: Enter the DNS timeout values you wish to use.

Status: Indicates the connection status, which is automatically determined by the system.

The screenshot shows the D-Link configuration interface for the DCS-6010L modem. The 'DYNAMIC DNS' section is highlighted in orange. It contains a description of the feature and a link to sign up for D-Link's Free DDNS service. Below this is the 'DYNAMIC DNS SETTING' section, which includes a checkbox for 'Enable DDNS', a dropdown menu for 'Server Address' (set to www.dlinkddns.com), and input fields for 'Host Name', 'User Name', 'Password', and 'Verify Password'. There is also a 'Timeout' field set to 24 hours and a 'Status' field set to 'Inactive'. 'Save Settings' and 'Don't Save Settings' buttons are present at the bottom of the settings section.

Image Setup

In this section, you may configure the video image settings for your camera. A preview of the image will be shown in Live Video.

Mirror: This will mirror the image horizontally.

Flip: This will flip the image vertically. When turning Flip on, you may want to consider turning Mirror on as well.

Power Line: Select the frequency used by your power lines to avoid interference or distortion.

White Balance: Use the drop-down box to change white balance settings to help balance colors for different environments. You can choose from Auto, Outdoor, Indoor, Fluorescent, and Push Hold.

Exposure Mode: Changes the exposure mode. Use the drop-down box to set the camera for Indoor, Outdoor, or Night environments, or to Moving to capture moving objects. The Low Noise option will focus on creating a high-quality picture without noise. You can also create 3 different custom exposure modes. The Max Gain setting will allow you to control the maximum amount of gain to apply to brighten the picture.

Denoise: This setting controls the amount of noise reduction that will be applied to the picture.

Brightness: Adjust this setting to compensate for backlit subjects.

The screenshot shows the D-Link web interface for the DCS-6010L camera. The top navigation bar includes 'LIVE VIDEO', 'SETUP', 'ADVANCED', 'MAINTENANCE', 'STATUS', and 'HELP'. The 'SETUP' tab is active, and the 'IMAGE SETUP' sub-tab is selected. A live video preview shows a fisheye view of a room. The 'IMAGE SETTINGS' panel on the right contains the following controls:

- Mirror: On Off
- Flip: On Off
- Power Line: 60 Hz 50 Hz
- White Balance: Auto (dropdown)
- Brightness: 4 (slider)
- Contrast: 1 (dropdown)
- Saturation: 3 (dropdown)
- Sharpness: 3 (dropdown)
- Mount type: Ceiling (dropdown)

A 'Reset Default' button is located at the bottom of the settings panel. On the far right, there is a 'Helpful Hints...' section with text explaining the functions of Mirror, Flip, Power Line, White Balance, Brightness, Contrast, Saturation, and Sharpness.

Contrast: Adjust this setting to alter the color intensity/strength.

Saturation: This setting controls the amount of coloration, from grayscale to fully saturated.

Sharpness: Specify a value from 0 to 8 to specify how much sharpening to apply to the image.

Reset Default Click this button to reset the image to factory default settings.

Mounting: Select the correct mounting type from either **Ceiling**, **Wall**, or **Desktop** to ensure the PTZ controls respond accurately.

D-Link

DCS-6010L // LIVE VIDEO SETUP ADVANCED MAINTENANCE STATUS HELP

IMAGE SETUP
Changes to your IP camera settings are made immediately.

LIVE VIDEO

IMAGE SETTINGS

Mirror On Off
 Flip On Off
 Power Line 60 Hz 50 Hz
 White Balance **Auto**
 Brightness **4**
 Contrast **1**
 Saturation **3**
 Sharpness **3**
 Mount type **Ceiling**

Helpful Hints...

Privacy Mask: Click the attached box to activate this function. Now use your mouse to draw a rectangle covering the area you want hidden. Click the box again to deactivate the function.

Mirror: This function horizontally reverses your images 180 degrees.

Flip: This function vertically reverses your images 180 degrees.

Power Line: This setting is used to remove 50/60 Hz flicker.

White Balance: White Balance is the process of removing unrealistic color casts, so that objects which appear white in person are rendered white in your photo.

Brightness: It is used to compensate for backlight scenes.

Contrast: It may help to improve the image under a dull grey sky.

Saturation: It controls the strength of color from black and white to bold colors.

Sharpness: Controls the amount of sharpening applied to the image.

SECURITY

Audio and Video

You may configure up to 3 video profiles with different settings for your camera. Hence, you may set up different profiles for your computer and mobile display. In addition, you may also configure the two-way audio settings for your camera. After making any changes, click the **Save Settings** button to save your changes.

Mode: Set the video codec to be used to JPEG, MPEG-4, or H.264.

Frame size: This sets the resolution of the video stream. (1600 x 1200, 1200 x 900, 800 x 600, 400 x 300)

Maximum frame rate: A higher frame rate provides smoother motion for videos, and requires more bandwidth. Lower frame rates will result in stuttering motion, and requires less bandwidth.

Video Quality: This limits the maximum frame rate, which can be combined with the "Fixed quality" option to optimize the bandwidth utilization and video quality. If fixed bandwidth utilization is desired regardless of the video quality, choose "Constant bit rate" and select the desired bandwidth.

Constant bit rate: The bps will affect the bit rate of the video recorded by the camera. Higher bit rates result in higher video quality.

Fixed quality: Select the image quality level for the camera to try to maintain. High quality levels will result in increased bit rates.

Encoding Choose between G.726 or G.711

The screenshot shows the D-Link DCS-6010L web interface. The main navigation bar includes 'LIVE VIDEO', 'SETUP', 'ADVANCED', 'MAINTENANCE', 'STATUS', and 'HELP'. The 'SETUP' tab is active, and the 'AUDIO AND VIDEO' section is selected. The interface is divided into several sections:

- AUDIO AND VIDEO:** A summary section with a 'Save Settings' button.
- VIDEO PROFILE 1:**
 - Mode: H.264
 - Frame size: 1600x1200
 - Maximum frame rate: 15
 - Video quality: Excellent
 - Constant bit rate: 2M
 - Fixed quality: Excellent
- VIDEO PROFILE 2:**
 - Mode: JPEG
 - Frame size: 400x300
 - Maximum frame rate: 25
 - Video quality: Excellent
- VIDEO PROFILE 3:**
 - Mode: H.264
 - Frame size: 400x300
 - Maximum frame rate: 25
 - Video quality: Excellent
 - Constant bit rate: 512K
 - Fixed quality: Excellent
- AUDIO SETTINGS:**
 - Encoding: G.726
 - Audio in off:
 - Audio in gain level: 20dB
 - Audio out off:
 - Audio out volume level: 10

Helpful Hints on the right side provide additional information:

- Higher frame size, frame rate and bit rate gives better video quality. At the same time, it requires more network bandwidth.
- For best viewing results on a mobile phone, we suggest setting the Frame Rate to 5fps and the Bit Rate to 64 kbps.
- Note: It can be H.264, JPEG or MPEG4. In JPEG mode, the video frames are independent, MPEG4 consumes much less network bandwidth than JPEG, and H.264 can use less bandwidth but better image quality.
- Frame Size: 4 options exist for the sizes of the video display. It is recommended using 400x300 for mobile viewing and 1600x1200 for computer viewing.
- View window area: The viewing region of the current video stream.
- Max frame rate: The maximum number of frames that is displayed in 1 second. 30fps is the highest video quality for this camera. In general, any frame rate above 15 fps is imperceptible to the human eye.
- Video Quality: This limits the maximal refresh frame rate, which can be combined with the "Fixed quality" to optimize the bandwidth utilization and video quality. If the user wants to fix the bandwidth utilization regardless of the video quality, choose "Constant bit rate" and select the desired bandwidth.
- Audio Settings: You can use the option to switch the external microphone on/off or adjust the volume.

Audio in off: Selecting this checkbox will mute incoming audio.

Audio in gain level: This setting controls the amount of gain applied to incoming audio to increase its volume.

Audio out off: Selecting this checkbox will mute outgoing audio.

Audio out volume level: This setting controls the amount of gain applied to outgoing audio to increase its volume.

AUDIO AND VIDEO

This section allows you to configure the sound and video of your camera. You can configure different settings depending on whether you are viewing content from a PC or a Mobile Phone / PDA.

VIDEO PROFILE 1

Mode:

Frame size:

Maximum frame rate:

Video quality

Constant bit rate:

Fixed quality:

VIDEO PROFILE 2

Mode:

Frame size:

Maximum frame rate:

Video quality:

VIDEO PROFILE 3

Mode:

Frame size:

Maximum frame rate:

Video quality

Constant bit rate:

Fixed quality:

AUDIO SETTINGS

Encoding:

Audio in off

Audio in gain level:

Audio out off

Audio out volume level:

Preset

This screen allows you to set preset points for the ePTZ function of the camera, which allows you to look around the camera's viewable area by using a zoomed view. Presets allow you to quickly go to and view a specific part of the area your camera is covering, and you can create preset sequences, which will automatically change the camera's view between the different presets according to a defined order and timing you can set.

Arrow Buttons and Home Button: Use these buttons to move to a specific part of the viewing area, which you can then set as a preset. Click the Home button to return to the center of the viewing area.

Input Preset Name: Enter the name of the preset you want to create, then click the **Add** button to make a new preset. If an existing preset has been selected from the Preset List, you can change its name by typing in a new name, then clicking the **Rename** button.

Preset List: Click this drop-down box to see a list of all the presets that have been created. You can select one, then click the **GoTo** button to change the displayed camera view to the preset. Clicking the **Remove** button will delete the currently selected preset.

The screenshot displays the D-Link configuration web interface for the DCS-6010L camera. The main navigation menu on the left includes options like Setup Wizard, Network Setup, Wireless Setup, Dynamic DNS, Image Setup, Audio and Video, Preset, Motion Detection, Time and Date, Event Setup, SD Card, and Logout. The 'Preset' option is currently selected.

The main content area is titled 'PRESET CONTROL' and features a live video feed of the camera's view. Below the video feed is a directional pad with an 'Add' button. To the right of the video feed are four dropdown menus for 'Pan speed', 'Tilt speed', 'Zoom speed', and 'Auto Pan speed', with values of 0, 0, 0, and 1 respectively.

Below the video feed and controls are two sections: 'PRESET' and 'PRESET SEQUENCE'. The 'PRESET' section has an 'Input Preset Name' field, 'Add' and 'Rename' buttons, and a 'Preset List' dropdown menu with 'GoTo' and 'Remove' buttons. The 'PRESET SEQUENCE' section has a 'Sequence speed' dropdown menu and an 'Add' button.

The right sidebar contains 'Helpful Hints...' with instructions on how to use the Pan, Tilt, and Zoom (PTZ) controls to move the camera view to a specific position and save it as a preset. It also explains the 'GoTo' button and the 'Preset Sequence' feature.

Preset Sequence: This section allows you to create a preset sequence, which automatically moves the camera's view between a set of preset views.

Preset List: To add a preset to the sequence, select it from the drop-down box at the bottom of this window, set the **Dwell time** to determine how long the camera view will stay at that preset, then click the **Add** button. The preset name will appear in the list, followed by the dwell time to view that preset for.

You can rearrange your presets in the sequence by selecting a preset in the sequence, then clicking the arrow buttons to move it higher or lower in the current sequence.

Clicking the trash can button will remove the currently selected preset from the sequence.

If you want to change the dwell time for a preset, select it from the list, enter a new dwell time, then click the **Update** button.

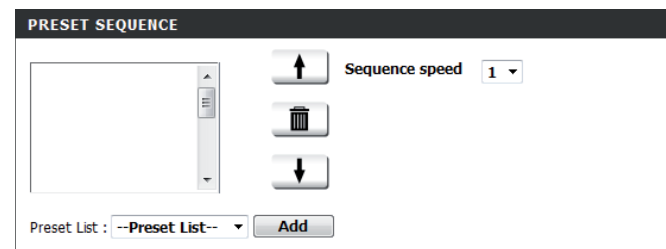

Motion Detection

Enabling Video Motion will allow your camera to use the motion detection feature. You may draw a finite motion area that will be used for monitoring. After making any changes, click the **Save Settings** button to save your changes.

Enable Video Motion: Select this box to enable the motion detection feature of your camera.

Sensitivity: Specifies the measurable difference between two sequential images that would indicate motion. Please enter a value between 0 and 100.

Percentage: Specifies the amount of motion in the window being monitored that is required to initiate an alert. If this is set to 100%, motion is detected within the whole window will trigger a snapshot.

Draw Motion Area: Draw the motion detection area by dragging your mouse in the window (indicated by the red square).

Erase Motion Area: To erase a motion detection area, simply click on the red square that you wish to remove.

Right clicking on the camera image brings up the following menu options:

Select All: Draws a motion detection area over the entire screen.

Clear All: Clears any motion detection areas that have been drawn.

Restore: Restores the previously specified motion detection areas.

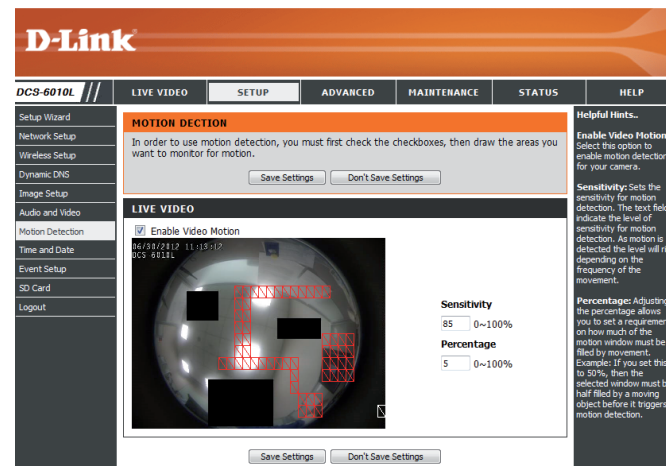

Time and Date

This section allows you to automatically or manually configure, update, and maintain the internal system clock for your camera. After making any changes, click the **Save Settings** button to save your changes.

Time Zone: Select your time zone from the drop-down menu.

Enable Daylight Saving: Select this to enable Daylight Saving Time.

Auto Daylight Saving: Select this option to allow your camera to configure the Daylight Saving settings automatically.

Set Date and Time Manually: Selecting this option allows you to configure the Daylight Saving date and time manually.

Offset: Sets the amount of time to be added or removed when Daylight Saving is enabled.

Synchronize with NTP Server: Enable this feature to obtain time automatically from an NTP server.

NTP Server: Network Time Protocol (NTP) synchronizes the DCS-6010L with an Internet time server. Choose the one that is closest to your location.

Set the Date and Time Manually: This option allows you to set the time and date manually.

Copy Your Computer's Time Settings: This will synchronize the time information from your PC.

D-Link

DCS-6010L // LIVE VIDEO SETUP ADVANCED MAINTENANCE STATUS HELP

TIME AND DATE
You can set the current time for the IP camera.
Save Settings Don't Save Settings

TIME CONFIGURATION
Time Zone (GMT+08:00) Taipei
 Enable Daylight Saving
 Auto Daylight Saving
 Set date and time manually
 Offset: +2:00
 Start time: Month 5, Week 1, Day of week Sunday, Hour 00, Minutes 00
 End time: Month 10, Week 1, Day of week Sunday, Hour 00, Minutes 00

AUTOMATIC TIME CONFIGURATION
 Synchronize with NTP Server
 NTP Server: ntp.dlink.com.tw << Select NTP Server >>

SET DATE AND TIME MANUALLY
 Set date and time manually
 Year: 2012, Month: 6, Day: 30
 Hour: 11, Minute: 13, Second: 22
 Copy Your Computer's Time Settings
 Save Settings Don't Save Settings

Helpful Hints...
 Good timekeeping is important for accurate logs and scheduled renewal rules.
Time Zone: Select your time zone from the drop-down menu.
Enable Daylight Saving: Select this to enable the daylight saving time.
Auto Daylight Saving: When you select it, the clock is automatically adjusted according to the daylight saving time of the selected time zone.
Offset: Select the time offset, if your location observes daylight saving time.
Synchronize with NTP Server: With the option selected, the camera will synchronize the time settings with the NTP server over the Internet whenever the camera starts up. If the timeserver cannot be reached, no time settings will be applied.
NTP Server: Network Time Protocol (NTP) synchronizes the IP camera with an Internet time server. Choose the one that is closest to your location.
Copy Your Computer's Time Settings: This will synchronize the time information from your PC.

Event Setup

In a typical application, when motion is detected, the DCS-6010L sends images to a FTP server or via e-mail as notifications. As shown in the illustration below, an event can be triggered by many sources, such as motion detection. When an event is triggered, a specified action will be performed. You can configure the Network Camera to send snapshots or videos to your e-mail address or FTP site.

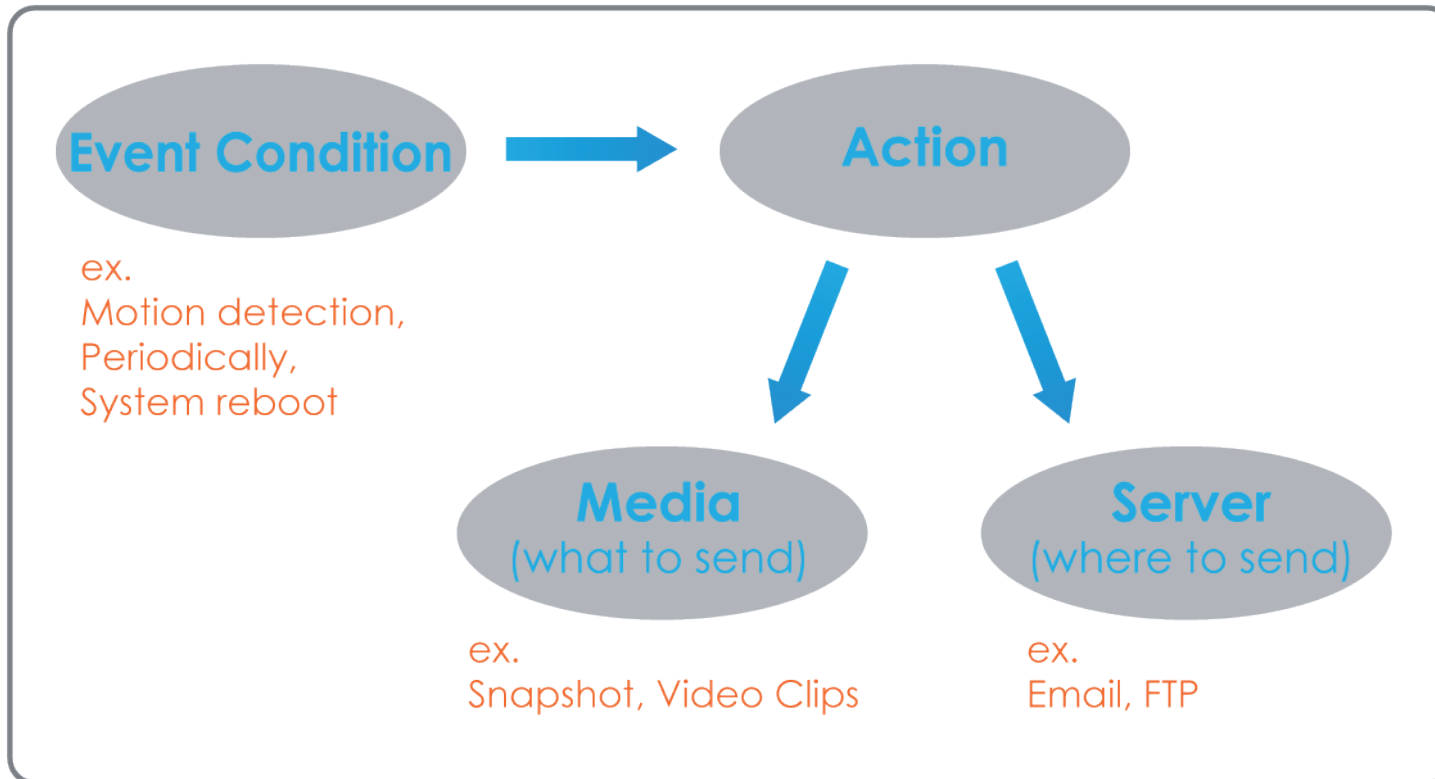

To start plotting an event, it is suggested to configure server and media columns first so that the Network Camera will know what action shall be performed when a trigger is activated.

The Event Setup page includes 4 different sections.

- Event
- Server
- Media
- Recording

1. To add a new item - "event, server or media," click **Add**. A screen will appear and allow you to update the fields accordingly.
2. To delete the selected item from the pull-down menu of event, server or media, click **Delete**.
3. Click on the item name to pop up a window for modifying.

D-Link

DCS-6010L // LIVE VIDEO **SETUP** ADVANCED MAINTENANCE STATUS HELP

EVENT SETUP

There are four sections in Event Setup page. They are event, server, media and recording. Click Add to pop a window to add a new item of event, server, media or recording. Click Delete to delete the selected item from event, server, media or recording. Click on the item name to pop a window to edit it. There can be at most 3 events and 2 recording. There can be at most 5 server and 5 media configurations.

SERVER

Name	Type	Address/Location
Server1	Email	mail@d-link.com

Add Server1 Delete

MEDIA

Media freespace: 6700KB

Name	Type	Source
Media1	Video clip	Profile 1

Add Media1 Delete

EVENT

Name	Status	Sun	Mon	Tue	Wed	Thu	Fri	Sat	Time	Trigger
Event1	ON	V	V	V	V	V	V	V	00:00~23:59	Motion

Add Event1 Delete

RECORDING

Name	Status	Sun	Mon	Tue	Wed	Thu	Fri	Sat	Time	Source	Destination

Add Delete

Helpful Hints...

Suggest setting server and media first before setting event. The servers and media which selected in event list are not be able to modify or delete. Please remove them first from the event if you want to delete or modify them. Recommend using different media in different event to make use all media be produced and received correctly. If using the same media in different events and the events trigger almost simultaneously, the servers in the second triggered event will not receive any media, there would be only notifications.

SECURITY

Copyright © 2011 D-Link Corporation.

Add Server

You can configure up to 5 servers to save snapshots and/or video to. After making any changes, click the **Save Settings** button to save your changes.

Server Name: Enter the unique name of your server.

E-mail: Enter the configuration for the target e-mail server account.

FTP: Enter the configuration for the target FTP server account.

Network Storage: Specify a network storage device. Only one network storage device is supported.

SD Card: Use the camera's onboard SD card storage.

SERVER

You can set at most 5 different servers here for different event.

SERVER TYPE

Server Name:

Email

Sender email address

Recipient email address

Server address

User name

Password

Port

This server requires a secure connection (StartTLS)

FTP

Server address

Port

User name

Password

Remote folder name

Passive mode

Network storage

Network storage location
(for example: \\my_nas\disk\folder)

Workgroup

User name

Password

Primary WINS server

SD Card

Add Media

There are three types of media, **Snapshot**, **Video Clip**, and **System Log**. After making any changes, click the **Save Settings** button to save your changes.

Media Name: Enter a unique name for media type you want to create.

Snapshot: Select this option to set the media type to snapshots.

Source: Set the video profile to use as the media source. Refer to **Audio and Video** on "Audio and Video" on page 37 for more information on video profiles.

Send pre-event image(s) [0~4]: Set the number of pre-event images to take. Pre-event images are images taken before the main event snapshot is taken.

Send post-event image(s) [0~7]: Set the number of post-event images to take. Post-event images are images taken after the main event snapshot is taken. You can set up to 7 post-event images to be taken.

File name prefix: The prefix name will be added on the file name.

Add date and time suffix to file name: Check it to add timing information as file name suffix.

MEDIA

You can set at most 5 different media here for different event.

Save Settings Don't Save Settings

MEDIA TYPE

Media name:

Snapshot

Source: Profile 1

Send pre-event image(s) [0~4]

Send post-event image(s) [0~7]

File Name Prefix:

Add date and time suffix to file name

Video Clip

Source: Profile 1

Pre-event recording: Second(s) [0~4]

Maximum duration: Second(s) [1~100]

Maximum file size: Kbytes [100~5000]

File Name Prefix:

System log

Save Settings Don't Save Settings

Video clip: Select this option to set the media type to video clips.

Source: Set the video profile to use as the media source. Refer to "Audio and Video" on page 37 for more information on video profiles.

Pre-event recording: This sets how many seconds to record before the main event video clip starts. You can record up to 4 seconds of pre-event video.

Maximum duration: Set the maximum length of video to record for your video clips.

Maximum file size: Set the maximum file size to record for your video clips.

File name prefix: This is the prefix that will be added to the filename of saved video clips.

System log: Select this option to set the media type to system logs. This will save the event to the camera system log, but will not record any snapshots or video.

The screenshot shows a configuration window titled "MEDIA" with a grey header bar. Below the header, there is a message: "You can set at most 5 different media here for different event." and two buttons: "Save Settings" and "Don't Save Settings". The main content area is titled "MEDIA TYPE" and contains three radio button options: "Snapshot", "Video Clip", and "System log". The "Snapshot" option is selected. Under "Snapshot", there is a "Source" dropdown menu set to "Profile 1", a "Send" field with "1" and "pre-event image(s) [0~4]", another "Send" field with "1" and "post-event image(s) [0~7]", a "File Name Prefix" text box, and a checkbox for "Add date and time suffix to file name". The "Video Clip" option is unselected. Under "Video Clip", there is a "Source" dropdown menu set to "Profile 1", a "Pre-event recording" field with a text box and "Second(s) [0~4]", a "Maximum duration" field with a text box and "Second(s) [1~100]", a "Maximum file size" field with a text box and "Kbytes [100~5000]", and a "File Name Prefix" text box. The "System log" option is unselected. At the bottom of the window, there are two buttons: "Save Settings" and "Don't Save Settings".

Add Event

Create and schedule up to 2 events with their own settings here. After making any changes, click the **Save Settings** button to save your changes.

Event name: Enter a name for the event.

Enable this event: Select this box to activate this event.

Priority: Set the priority for this event. The event with higher priority will be executed first.

Delay: Select the delay time before checking the next event. It is used for motion detection events.

Trigger: Specify the input type that triggers the event.

Video Motion Detection: Motion is detected during live video monitoring. Select the windows that need to be monitored.

Periodic: The event is triggered in specified intervals. The trigger interval unit is in minutes.

System Boot: Triggers an event when the system boots up.

Network Lost: Triggers an event when the network connection is lost.

Passive Infrared Sensor: Triggers an event when the PIR sensor is activated by moving infrared objects even in dark environment.

Time: Select **Always** or enter the time interval.

Server: Specify the location where the event information should be saved to.

EVENT

You can set at most 3 events like motion detection or digital input trigger here and arrange the detection schedule at the same time.

EVENT

Event name:

Enable this event

Priority: normal

Delay for 10 seconds before detecting next event [For motion detection and digital input]

TRIGGER

Video motion detection

Periodic
Trigger every 1 minutes

System boot

Network lost

EVENT SCHEDULE

Sun Mon Tue Wed Thu Fri Sat

Time

Always

From 00 00 To 23 59

Add Recording

Here you can configure and schedule the recording settings. After making any changes, click the **Save Settings** button to save your changes.

Recording entry name: The unique name of the entry.

Enable this recording: Select this to enable the recording function.

Priority: Set the priority for this entry. The entry with a higher priority value will be executed first.

Source: The source of the stream.

Recording schedule: Scheduling the recording entry.

Recording settings: Configuring the setting for the recording.

Destination: Select the folder where the recording file will be stored.

Total cycling recording size: Please input a HDD volume between 1MB and 2TB for recording space. The recording data will replace the oldest record when the total recording size exceeds this value. For example, if each recording file is 6MB, and the total cyclical recording size is 600MB, then the camera will record 100 files in the specified location (folder) and then will delete the oldest file and create new file for cyclical recording.

Please note that if the free HDD space is not enough, the recording will stop. Before you set up this option please make sure your HDD has enough space, and it is better to not save other files in the same folder as recording files.

DCS-6010L // LIVE VIDEO SETUP ADVANCED MAINTENANCE STATUS HELP

RECORDING

You can setup schedule recording to network storage with your specify week day and time period.

Save Settings Don't Save Settings

RECORDING

Recording entry name:

Enable this recording

Priority: normal

Source: Profile 1

RECORDING SCHEDULE

Sun Mon Tue Wed Thu Fri Sat

Time

Always

From 00:00 To 23:59

RECORDING SETTINGS

Destination: None

Total cycling recording size: 1000 Mbytes (200~2000000)

Size of each file for recording: 10 Mbytes

Time of each file for recording: 10 seconds

File Name Prefix:

Save Settings Don't Save Settings

Helpful Hints...

Recording: Enable this option if you want to upload this recording to a shared folder on the network.

Recording schedule: Select the day(s) according to when you want the IP camera to make a video clip.

Always: This enables the IP camera to make video clips continuously.

From: The time range specified for the video clip.

Total cycling recording size: Please input the network path of your network storage, it will like "\\DNS\IPCamRecord\". If the network storage need authentication, please enter your user name and password here.

Note: Please Format SD card before use. The entire data in the SD card will be erased after formatting.

Size of each file for recording: If this is selected, files will be separated based on the file size you specify.

Time of each file for recording: If this is selected, files will be separated based on the maximum length you specify.

File Name Prefix: The prefix name will be added on the file name of the recording file(s).

The screenshot displays the D-Link DCS-6010L web interface. The top navigation bar includes 'LIVE VIDEO', 'SETUP', 'ADVANCED', 'MAINTENANCE', 'STATUS', and 'HELP'. The left sidebar lists various setup options: Setup Wizard, Network Setup, Wireless Setup, Dynamic DNS, Image Setup, Audio and Video, Motion Detection, Time and Date, Event Setup, SD Card, and Logout. The main content area is titled 'RECORDING' and contains the following sections:

- RECORDING:** A section with a sub-header 'RECORDING' and a description: 'You can setup schedule recording to network storage with your specify week day and time period.' It includes 'Save Settings' and 'Don't Save Settings' buttons.
- RECORDING SCHEDULE:** A section with a sub-header 'RECORDING SCHEDULE' and a description: 'You can setup schedule recording to network storage with your specify week day and time period.' It includes 'Save Settings' and 'Don't Save Settings' buttons.
- RECORDING SETTINGS:** A section with a sub-header 'RECORDING SETTINGS' and a description: 'You can setup schedule recording to network storage with your specify week day and time period.' It includes 'Save Settings' and 'Don't Save Settings' buttons.

Helpful Hints:

- Recording:** Disable this option if you want to upload the recording to a shared folder on the network.
- Recording schedule:** Select the day(s) according to when you want the IP camera to make a video clip.
- Always:** This enables the IP camera to make video clips continuously.
- From:** The time range specified for the video clip.
- Total cycling recording size:** Please input the network path of your network storage, it will use "D:\IPCamRecord\". If the network storage need authentication, please enter your user name and password here.
- Note:** Please Format SD card before use. The entire data in the SD card will be erased after formatting.

SD Card

Here you may browse and manage the recorded files which are stored on the SD card.

Format SD Card: Click this icon to automatically format the SD card and create "Picture" & "Video" folders.

View Recorded Picture: If the picture files are stored on the SD card, click on the picture folder and choose the picture file you would like to view.

Playback Recorded Video: If video files are stored on the SD card, click on the video folder and choose the video file you would like to view.

Refresh: Reloads the file and folder information from the SD card.

The screenshot shows the D-Link DCS-6010L web interface. The main content area is titled "SD CARD" and contains the following elements:

- A header: "SD CARD" with a sub-header: "Here you could browse and manage the record files which stored in SD card."
- A "Format SD Card" button.
- A table showing the SD card's status and file list:

File	Num of files	Size
Video	3	
Picture	1	
- A "Refresh" button.
- A status bar at the bottom: "Total:1976528KB, Used:1976528KB, Free:0KB".

On the right side, there are "Helpful hints" for "Format SD Card", "View recorded pictures", and "Playback recorded videos".

Advanced HTTPS

This page allows you to install and activate an HTTPS certificate for secure access to your camera. After making any changes, click the **Save Settings** button to save your changes.

Enable HTTPS Secure Connection: Enable the HTTPS service.

Create Certificate Method: Choose the way the certificate should be created. Three options are available:

- Create a self-signed certificate automatically
- Create a self-signed certificate manually
- Create a certificate request and install

Status: Displays the status of the certificate.

Note: The certificate cannot be removed while the HTTPS is still enabled. To remove the certificate, you must first uncheck **Enable HTTPS secure connection**.

The screenshot shows the D-Link web interface for the DCS-6010L camera. The 'ADVANCED' tab is selected. The 'HTTPS' section is active, displaying a message: 'To enable HTTPS, you have to create and install certificate first.' Below this, there are two buttons: 'Save Settings' and 'Don't Save Settings'. The 'HTTPS' section is checked, and the 'Create certificate method' section has three radio button options: 'Create self-signed certificate automatically' (selected), 'Create self-signed certificate manually', and 'Create certificate request and install'. The 'Create certificate' section shows a 'Create' button and the text 'Private key existed'. The 'CERTIFICATE INFORMATION' section displays the following details: Status: Active, Country: TW, State or province: Taiwan, Locality: Taipei, Organization: D-Link Taiwan, Organization Unit: R&D Dept., and Common Name: www.dlink.com.tw. There are buttons for 'CSR Property', 'Certificate Property', and 'Remove'. A 'Helpful Hints...' section on the right contains a note: '1. The certificate can't be removed while the HTTPS is still enable. To remove the certificate you have to uncheck the "Enable HTTPS secure connection" first.'

Access List

Here you can set access permissions for users to view your DCS-6010L.

Allow list: The list of IP addresses that have the access right to the camera.

Start IP address: The starting IP Address of the devices (such as a computer) that have permission to access the video of the camera. Click **Add** to save the changes made.

Note: A total of seven lists can be configured for both columns.

End IP address: The ending IP Address of the devices (such as a computer) that have permission to access the video of the camera.

Delete allow list: Remove the customized setting from the Allow List.

Deny list: The list of IP addresses that have no access rights to the camera.

Delete deny list: Remove the customized setting from the Delete List.

For example:

When the range of the Allowed List is set from 1.1.1.0 to 192.255.255.255 and the range of the Denied List is set from 1.1.1.0 to 170.255.255.255. Only users with IPs located between 171.0.0.0 and 192.255.255.255 can access the Network Camera.

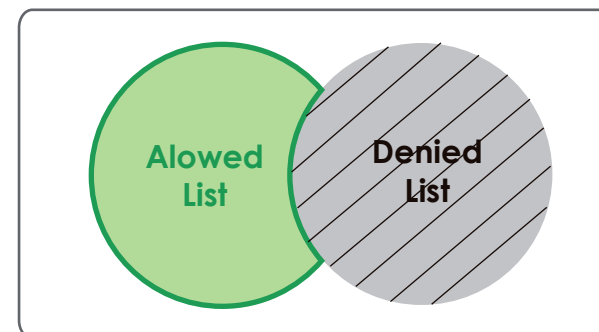
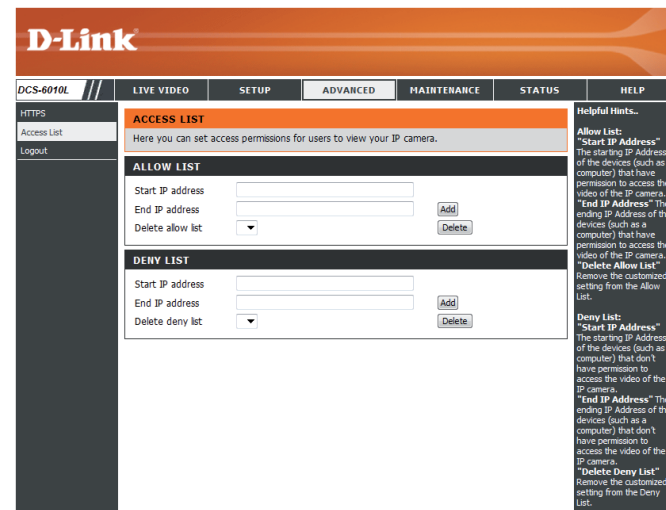

Maintenance

Device Management

You may modify the name and administrator's password of your camera, as well as add and manage the user accounts for accessing the camera. You may also use this section to create a unique name and configure the OSD settings for your camera.

Admin Password Setting: Set a new password for the administrator's account.

Add User Account: Add new user account.

User Name: The user name for the new account.

Password: The password for the new account.

User List: All the existing user accounts will be displayed here. You may delete accounts included in the list, but you may want to reserve at least one as a guest account.

Camera Name: Create a unique name for your camera that will be added to the file name prefix when creating a snapshot or a video clip.

Enable OSD: Select this option to enable the On-Screen Display feature for your camera.

Label: Enter a label for the camera, which will be shown on the OSD when it is enabled.

Show Time: Select this option to enable the time-stamp display on the video screen.

The screenshot shows the D-Link web interface for the DCS-6010L camera. The top navigation bar includes 'LIVE VIDEO', 'SETUP', 'ADVANCED', 'MAINTENANCE', 'STATUS', and 'HELP'. The 'MAINTENANCE' section is selected, and the 'ADMIN' sub-section is active. The 'ADMIN' section contains the following options:

- ADMIN PASSWORD SETTING:** Fields for 'New Password' (63 characters maximum) and 'Retype Password', with a 'Save' button.
- ADD USER ACCOUNT:** Fields for 'User Name' (20 users maximum), 'New Password' (63 characters maximum), and 'Retype Password', with an 'Add' button.
- USER LIST:** A dropdown menu for 'User Name' and a 'Delete' button.
- DEVICE SETTING:** Fields for 'IP camera Name' (DCS-6010L, 63 characters maximum), 'Label' (DCS-6010L, 63 characters maximum), and 'Show time' (checked), with a 'Save' button.

A sidebar on the right contains 'Helpful Hints...' and a security warning: 'For security purposes, it is recommended that you change the password for your administrator account. Be sure to write down the new password to avoid having to reset the IP camera in the event that it is forgotten.'

System

In this section, you may backup, restore and reset the camera configuration, or reboot the camera.

Save To Local Hard Drive: You may save your current camera configuration as a file on your computer.

Local From Local Hard Drive: Locate a pre-saved configuration by clicking **Browse** and then restore the pre-defined settings to your camera by clicking **Load Configuration**.

Restore to Factory Default: You may reset your camera and restore the factory settings by clicking **Restore Factory Defaults**.

Reboot Device: This will restart your camera.

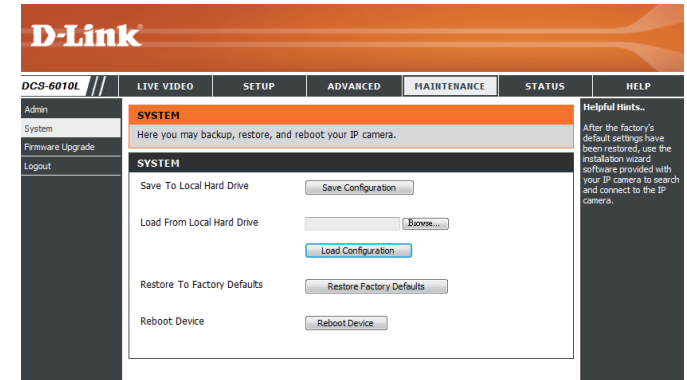

Firmware Upgrade

The camera's current firmware version will be displayed on this screen. You may visit the D-Link Support Website to check for the latest available firmware version.

To upgrade the firmware on your DCS-6010L, please download and save the latest firmware version from the D-Link Support Page to your local hard drive. Locate the file on your local hard drive by clicking the **Browse** button. Select the file and click the **Upload** button to start upgrading the firmware.

Current Firmware Version: Displays the detected firmware version.

Current Product Name: Displays the camera model name.

File Path: Locate the file (upgraded firmware) on your hard drive by clicking **Browse**.

Upload: Uploads the new firmware to your camera.

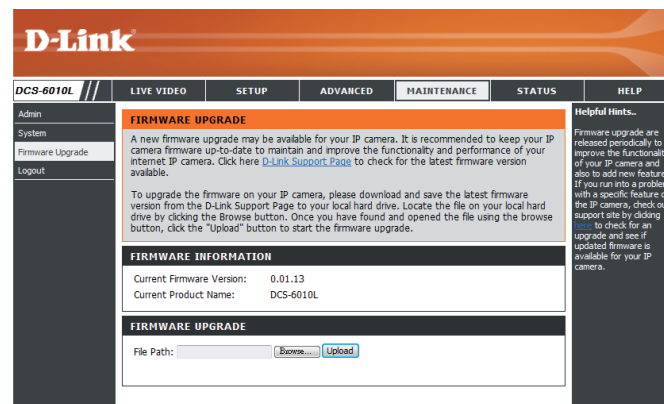

Status

Device Info

This page displays detailed information about your device and network connection.

The screenshot shows the D-Link web interface for the DCS-6010L camera. The top navigation bar includes 'DCS-6010L', 'LIVE VIDEO', 'SETUP', 'ADVANCED', 'MAINTENANCE', 'STATUS', and 'HELP'. The 'STATUS' tab is active, and the 'Device Info' sub-tab is selected. The main content area is titled 'DEVICE INFO' and contains a message: 'All of your network connection details are displayed on this page. The firmware version is also displayed here.' Below this is an 'INFORMATION' table with the following data:

INFORMATION	
IP camera Name	DCS-6010L
Time & Date	Sat Jun 30 11:17:22 2012
Firmware Version	0.01.13
MAC Address	F0:7D:68:09:A3:D9
IP Address	192.168.0.103
IP Subnet Mask	255.255.255.0
Default Gateway	192.168.0.1
Primary DNS	192.168.0.1
Secondary DNS	0.0.0.0
PPPoE	Disable
DDNS	Disable
Agent Version	2.0.15-b6

On the right side, there is a 'Helpful Hints..' section with the text: 'This page displays all the information about the IP camera and network settings.'

Logs

This page displays the log information of your camera. You may download the information by clicking **Download**. You may also click **Clear** to delete the saved log information.

D-Link

DCS-6010L // LIVE VIDEO SETUP ADVANCED MAINTENANCE STATUS HELP

Device Info
Log
Logout

SYSTEM LOG
The system log records IP camera events that have occurred.

CURRENT LOG

1. 2012-06-30 11:16:53 admin FROM 192.168.0.100 TURN ON LED
2. 2012-06-30 11:16:46 admin FROM 192.168.0.100 TURN OFF LED
3. 2012-06-30 11:15:59 MOTION STOPPED
4. 2012-06-30 11:15:56 IP CAMERA Received MOTION Trigger
5. 2012-06-30 11:15:56 MOTION STOPPED
6. 2012-06-30 11:14:48 SD CARD SIZE 1976528 KB
7. 2012-06-30 11:14:37 IP CAMERA Received MOTION Trigger
8. 2012-06-30 11:14:31 MOTION STOPPED
9. 2012-06-30 11:14:29 IP CAMERA Received MOTION Trigger
10. 2012-06-30 11:13:23 MOTION STOPPED
11. 2012-06-30 11:13:17 IP CAMERA Received MOTION Trigger
12. 2012-06-30 11:13:16 admin FROM 192.168.0.100 SET MOTION BLOCK TABLE
13. 2012-06-30 11:12:25 admin FROM 192.168.0.100 SET PROFILE 1 FRAMERATE 15
14. 2012-06-30 11:12:13 MOTION STOPPED
15. 2012-06-30 11:12:07 IP CAMERA Received MOTION Trigger
16. 2012-06-30 11:12:06 admin FROM 192.168.0.100 TURN ON MASK AREA 2
17. 2012-06-30 11:12:06 admin FROM 192.168.0.100 TURN ON MASK AREA 3
18. 2012-06-30 11:12:06 admin FROM 192.168.0.100 TURN ON MASK AREA 1
19. 2012-06-30 11:11:56 admin FROM 192.168.0.100 TURN OFF MASK AREA 2
20. 2012-06-30 11:11:56 admin FROM 192.168.0.100 TURN OFF MASK AREA 3

First Page Previous 20 Next 20
Clear Download

Helpful Hints..
You can save the log to your local hard IP camera by clicking the Download button, and you can clear the log by clicking on the Clear button.

Help

This page provides helpful information regarding camera operation.

The screenshot shows the D-Link DCS-6010L web interface. At the top is the D-Link logo. Below it is a navigation bar with tabs for LIVE VIDEO, SETUP, ADVANCED, MAINTENANCE, STATUS, and HELP. The HELP tab is selected. On the left side, there is a sidebar with 'Help' and 'Logout' links. The main content area is titled 'HELP' and contains a list of links for various sections: LIVE VIDEO (Camera), SETUP (Setup Wizard, Network Setup, Wireless Setup, Dynamic DNS, Image Setup, Audio and Video, Motion Detection, Time and Date, Event Setup, SD Card), ADVANCED (DI and DO, HTTPS, Access List), MAINTENANCE (Admin, System, Firmware Upgrade), and STATUS (Device Info, Log). At the bottom of the page, there is a 'SECURITY' section and a copyright notice: Copyright © 2011 D-Link Corporation.

DCS-6010L	LIVE VIDEO	SETUP	ADVANCED	MAINTENANCE	STATUS	HELP
Help Logout	HELP <ul style="list-style-type: none">LIVE VIDEOSETUPMAINTENANCEADVANCEDSTATUS					
	LIVE VIDEO <ul style="list-style-type: none">Camera					
	SETUP <ul style="list-style-type: none">Setup WizardNetwork SetupWireless SetupDynamic DNSImage SetupAudio and VideoMotion DetectionTime and DateEvent SetupSD Card					
	ADVANCED <ul style="list-style-type: none">DI and DOHTTPSAccess List					
	MAINTENANCE <ul style="list-style-type: none">AdminSystemFirmware Upgrade					
	STATUS <ul style="list-style-type: none">Device InfoLog					
SECURITY						
Copyright © 2011 D-Link Corporation.						

Technical Specifications

Camera	Camera Hardware Profile	<ul style="list-style-type: none"> ▪ 1/3.2" 2 megapixel progressive CMOS sensor ▪ Minimum illumination: 2.0 lux ▪ Built-in microphone and speaker ▪ 10x digital zoom ▪ Focal length: 1.25 mm ▪ Aperture: F2.0 	<ul style="list-style-type: none"> ▪ Angle of view: <ul style="list-style-type: none"> ▪ (H) 180° ▪ (V) 180° ▪ (D) 180°
	Image Features	<ul style="list-style-type: none"> ▪ Configurable image size, quality, frame rate, and bit rate ▪ Fisheye distortion correction ▪ Time stamp and text overlays 	<ul style="list-style-type: none"> ▪ Configurable shutter speed, brightness, saturation, contrast, and sharpness ▪ Configurable motion detection windows
	Video Compression	<ul style="list-style-type: none"> ▪ Simultaneous H.264/MPEG-4/MJPEG format compression ▪ H.264/MPEG-4 multicast streaming 	<ul style="list-style-type: none"> ▪ JPEG for still images
	Video Resolution	1600 x 1200, 1200 x 900, 800 x 600, 400 x 300	
	Audio Support	G.726, G.711	
	External Device Interface	<ul style="list-style-type: none"> ▪ 10/100 BASE-TX Fast Ethernet port ▪ IEEE 802.11n 2.4GHz single band wireless 	<ul style="list-style-type: none"> ▪ MicroSD/SDHC card slot
Network	Network Protocols	IPv6 IPv4 TCP/IP UDP ICMP DHCP client NTP client (D-Link) DNS client DDNS client (D-Link) SMTP client FTP client	HTTP / HTTPS Samba Client PPPoE UPnP port forwarding RTP / RTSP / RTCP IP filtering QoS CoS Multicast IGMP ONVIF compliant
	Security	<ul style="list-style-type: none"> ▪ Administrator and user group protection ▪ Password authentication 	<ul style="list-style-type: none"> ▪ HTTP and RTSP digest encryption

Appendix A: Technical Specifications

System Management	System Requirements for Web Interface	<ul style="list-style-type: none"> ▪ Browser: Internet Explorer, Firefox, Chrome, Safari 	
	Event Management	<ul style="list-style-type: none"> ▪ Motion detection ▪ Event notification and uploading of snapshots/video clips via e-mail or FTP 	<ul style="list-style-type: none"> ▪ Supports multiple SMTP and FTP servers ▪ Multiple event notifications ▪ Multiple recording methods for easy backup
	Remote Management	<ul style="list-style-type: none"> ▪ Take snapshots/video clips and save to local hard drive or NAS via web browser 	<ul style="list-style-type: none"> ▪ Configuration interface accessible via web browser
	Mobile Support	Windows 7/Vista/XP system, Pocket PC, or mobile phone	mydlink mobile app for iOS and Android mobile devices
	D-ViewCam™ System Requirements	<ul style="list-style-type: none"> ▪ Operating System: Microsoft Windows 7/Vista/XP ▪ Web Browser: Internet Explorer 7 or higher 	<ul style="list-style-type: none"> ▪ Protocol: Standard TCP/IP
	D-ViewCam™ Software Functions	<ul style="list-style-type: none"> ▪ Remote management/control of up to 32 cameras ▪ Viewing of up to 32 cameras on one screen 	<ul style="list-style-type: none"> ▪ Supports all management functions provided in web interface ▪ Scheduled motion triggered, or manual recording options
General	Weight	267 g +-5%	
	External Power Adaptor	Input: 100 to 240 V AC, 50/60 Hz	Output: 5 V DC, 1.2 A
	Power Consumption	3.9 watts +-5%	
	Temperature	Operating: 0 to 40 °C (32 to 104 °F)	Storage: -20 to 70 °C (-4 to 158 °F)
	Humidity	Operating: 20% to 80% non-condensing	Storage: 5% to 95% non-condensing
	Certifications	CE CE LVD	FCC C-Tick

Dimensions

