

DCS-7410

Version 1.10

# Day & Night Outdoor PoE Network Camera



## User Manual

Business Class Networking

---

# Table of Contents

<b>Product Overview</b> .....	<b>3</b>	Snapshot.....	47
Features .....	4	Digital Output .....	50
Package Contents .....	5	RS-485.....	51
System Requirements .....	5	Maintenance .....	51
Hardware Overview .....	6	Admin.....	51
Hardware Overview (Connectors) .....	7	System.....	53
Hardware Installation.....	8	Firmware Upgrade .....	54
Software Installation .....	10	Status .....	55
<b>Configuration</b> .....	<b>21</b>	Device Info.....	55
Using the Setup Wizard.....	21	Logs .....	56
Using the Configuration Menu .....	25	Help .....	57
Web-based Configuration Utility .....	26	<b>D-ViewCam Installation</b> .....	<b>58</b>
Live Video.....	27	Adding a Camera.....	61
Camera.....	27	<b>Troubleshooting</b> .....	<b>66</b>
Setup .....	29	<b>DI/DO</b> .....	<b>68</b>
Setup Wizard .....	29	<b>Networking Basics</b> .....	<b>69</b>
Internet Connection Setup Wizard .....	29	Check your IP address .....	69
Motion Detection Setup Wizard .....	33	Assigning a Static IP address.....	70
Network Setup .....	36	<b>Technical Specifications</b> .....	<b>71</b>
Dynamic DNS .....	38		
Image Setup .....	39		
Audio and Video .....	40		
Motion Detection.....	41		
Time and Date .....	43		
Recording .....	44		
Creating a Samba network drive for saving video..	46		

# Product Overview

The DCS-7410 is a day & night outdoor PoE network camera with built-in infrared LEDs. Equipped with a high-resolution Sony CCD image sensor, this camera provides you with excellent image quality and level of detail. The DCS-7410 can detect moving objects in total darkness, for distances of up to 30 meters. Embedded with a powerful SoC (System-on-Chip), the camera provides high-quality, real-time video compression in MPEG-4 and motion JPEG formats. These elements make the DCS-7410 an ideal solution for 24-hour surveillance.

The DCS-7410 is housed in an IP66 certified weatherproof casing, which protects the camera against rain and dust. You can also connect the camera to I/O sensors such as IR sensors, switches and alarm relays, and set up the system to send automated e-mail notifications for unusual events.

A live feed from the camera can be accessed on a 3G mobile network by using a compatible mobile phone or PDA with a 3G video player. The bundled D-ViewCam software is included to manage up to 32 cameras simultaneously, send automated e-mail alerts, and record video to your hard drive when motion is detected or according to a set schedule. The software allows you to manage and record videos to a Network Attached Storage (NAS) or a Network Video Recorder (NVR) device.

**Note:** Use of audio or video equipment for recording the image or voice of a person without their knowledge and consent is prohibited in certain states or jurisdictions. Nothing herein represents a warranty or representation that the D-Link product provided herein is suitable for the end-user's intended use under the applicable laws of his or her state. D-Link disclaims any liability whatsoever for any end-user use of the D-Link product, which fails to comply with applicable state, local, or federal laws.

# Features

- **Supports a variety of Protocols:** Supports TCP/IP networking, SMTP e-mail, HTTP, and other Internet related protocols. The DCS-7410 can easily be integrated into Internet/Intranet applications because of its standards-based features.
- **Remote Snapshots:** Save snapshots directly from the Web browser to a local hard drive without installing any software. This Snapshot feature allows you to conveniently capture images from a remote location.
- **Outdoor Deployment:** A built-in 802.3af compliant Power over Ethernet (PoE) port simplifies installation giving users the freedom to place the camera anywhere.
- **Web Configuration:** Using a web browser, an administrator can configure and manage the DCS-7410 directly and can also create and control up to 10 accounts with different settings.
- **3G Mobile Surveillance:** Access the camera's live feed by using a compatible mobile phone or PDA with a 3G video player, anywhere within a 3GPP service area.
- **Bundled D-ViewCam Software:** Manage up to 32 cameras simultaneously, send automated e-mail alerts, and record videos to a NAS or NVR device.
- **Applications:** The DCS-7410 makes an ideal solution for detailed remote monitoring for places such as homes, offices, banks, hospitals, child-care centers, amusement parks and other industrial and public monitoring areas. Connect the camera to I/O sensors, and set up the system to receive automated e-mail notification of all unusual events. The camera can also be used for intruder detection (motion-detection mode), capture of still images and video for archiving, and can be used for many more applications.

# Package Contents

- D-Link DCS-7410 Day & Night Outdoor PoE Network Camera
- CAT5 Ethernet Cable
- Power Adapter 12V, 1.25A
- Quick Installation Guide
- User Manual and Software on CD
- Camera Bracket

If any of the above items are missing, please contact your reseller.

**Note:** Using a power supply with a different voltage rating than the one included with the package may cause damage and will void the warranty for this product.



# System Requirements

- Windows® XP or Vista
- At least 256MB of memory (512MB recommended)
- An available Ethernet connection
- Internet Explorer 6 or higher
- VGA card resolution: 800 x 600 or higher
- CPU: 1.7GHz or higher (at least a 2.8GHz processor, 512MB memory, and a 32MB video card is required for viewing multiple cameras and recording with the D-ViewCam software)

# Hardware Overview

## Weatherproof Casing

The camera is housed in an IP66 certified weatherproof casing, which protects it against rain and dust.

## Adjustable Top Shield

Shields the camera sensor from direct sunlight while providing air ventilation for the camera.

## IR LEDs with Condenser

IR LEDs enables the camera to detect moving objects in total darkness for distances of up to 50 meters.

## Camera Bracket

Attaches to the camera and mount the camera on the wall.



# Hardware Overview

## Connectors

### I/O Connector

The DCS-7410 offers a 8 pin-contact terminal block. Two pairs are for input, one pair for output and RS485 terminals. The connector provides a physical interface to send and receive digital signals to and from a variety of external devices.

### Audio Out Connector

Speakers (not included) may be connected to the camera for a 2-way audio communication.

### DC Power Connector

Attach the Power Adapter to the DC connector and connect the power adapter to a power outlet.

### BNC

The BNC connector is used for professional video connections. It benefits users who integrate digital IP cameras into a traditional system (CCTV) for both analog and digital video streaming purposes.

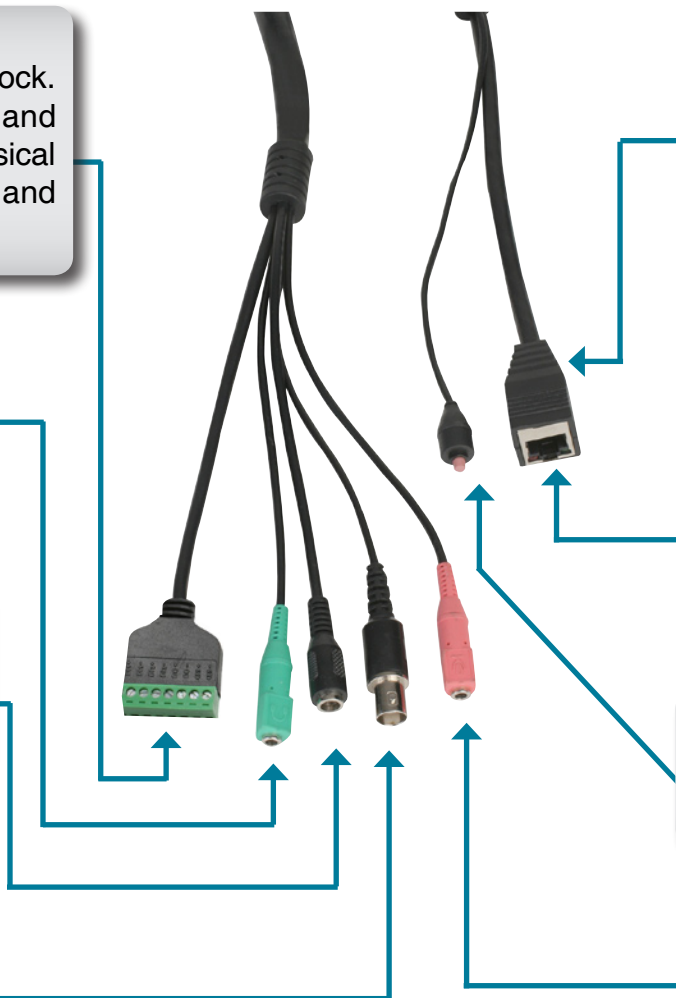

### Ethernet Cable Connector (PoE)

Plug the Ethernet cable into the RJ-45 PoE connector. When connected to a PoE switch, the built-in 802.3af compliant Power over Ethernet (PoE) eliminates the need for a nearby power outlet, giving you the freedom to place the camera anywhere.

### Link/Power LEDs

Lights up and changes color to indicate the Link and Power status of your camera.

Green LED indicates Link up/Link down/Traffic  
Red LED indicates Power on/Power off

### Reset Button

Resets the camera to factory defaults when pressed for 10 seconds.

### Microphone Connector

Connect an external microphone to the microphone connector to hear what is happening near your camera.

# Hardware Installation

Step1. Attach the camera bracket to the camera using screws (Front point).

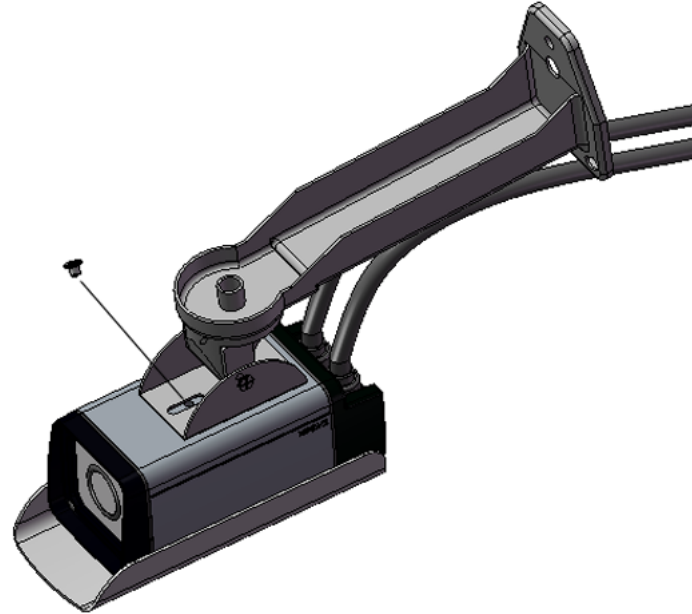

Step2. Attach the camera bracket to the camera using screws (Back point).

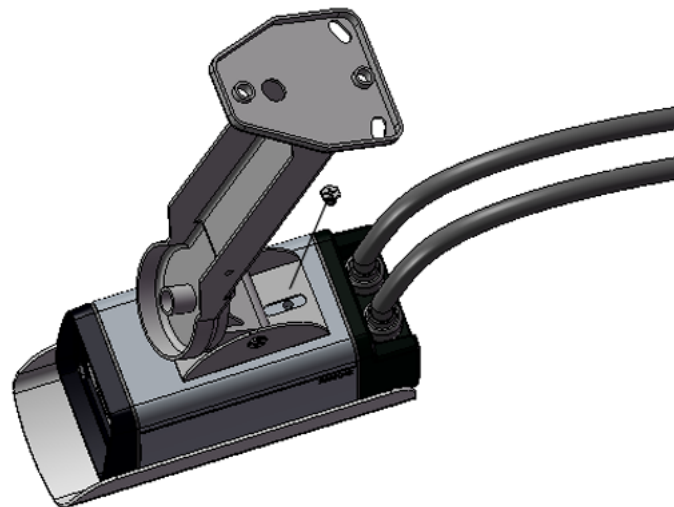



Step3. Connect the cables as required.

Refer to the Hardware Overview, Connectors section for details on the different connectors

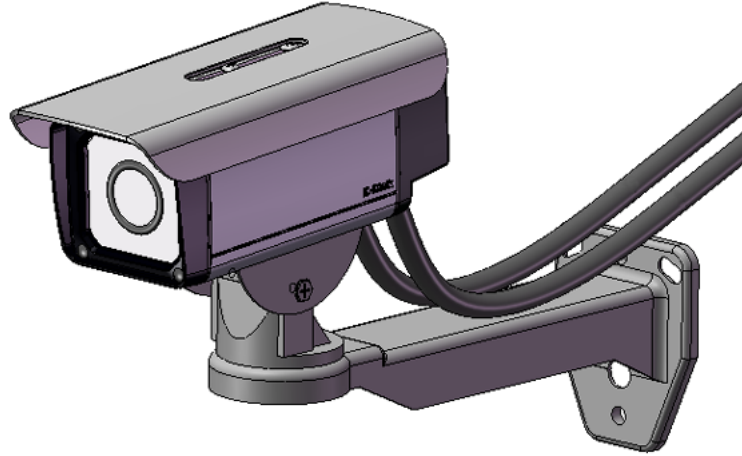

# Software Installation

Insert the Installation DCS-7410 driver CD into your computer's CD-ROM drive to start the autorun program. The **Setup Wizard** will guide you through the entire installation process from connecting your hardware to configuring your camera.

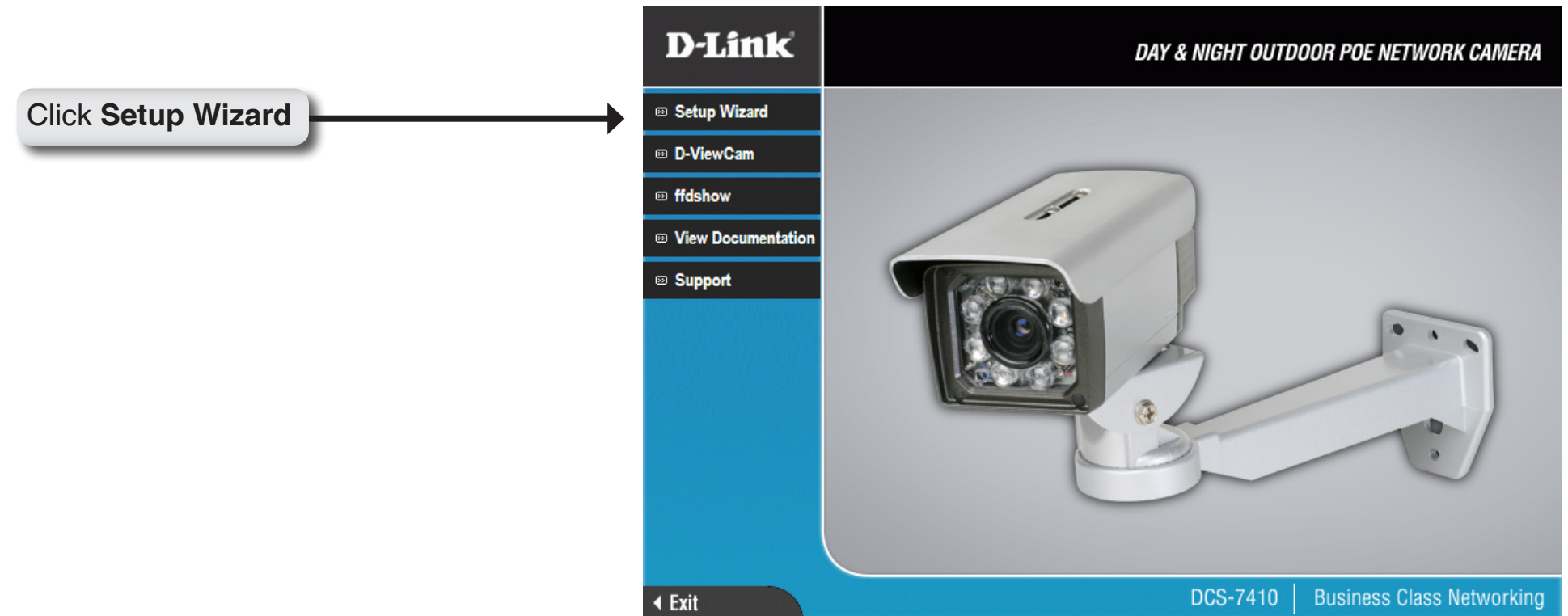

If the autorun program does not automatically start on your computer, go to **Windows**, click **Start > Run**. In the **Run** command box type **D:\DCS7410.exe**, where D: represents your CD-ROM drive.

After clicking **Setup Wizard**, the following window will open.  
Click **Next** to continue.

Click **Next**

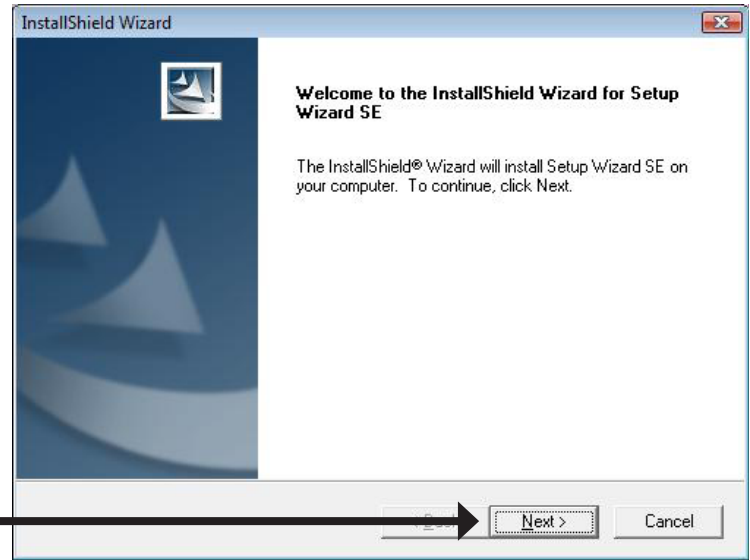

Click **Yes** to accept the License Agreement.

Click **Yes**

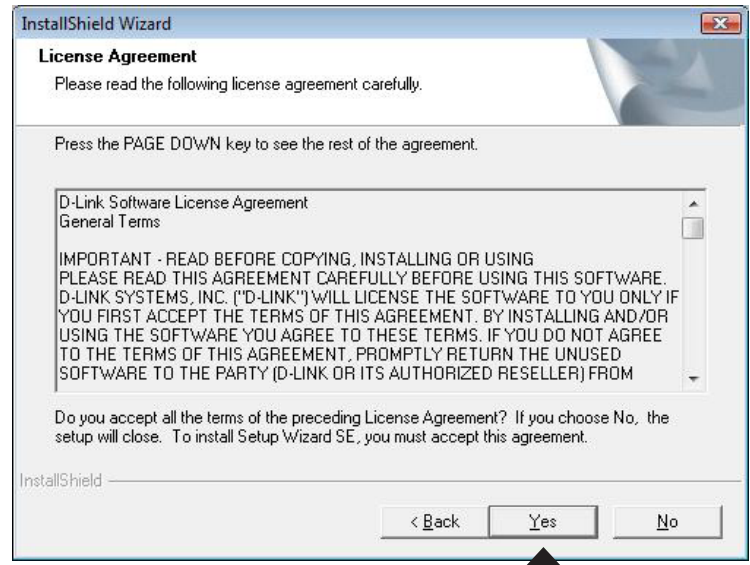

To start the installation process click **Next**.

**Note:** The installation may take several minutes to finish.

Click **Next**

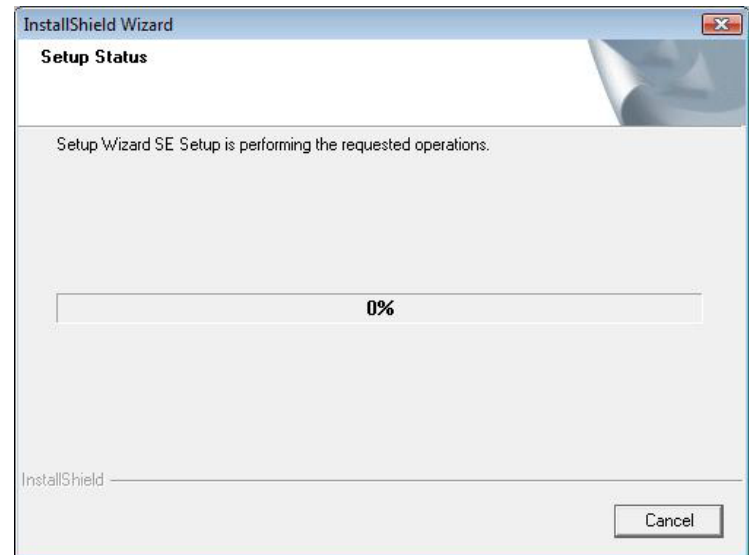
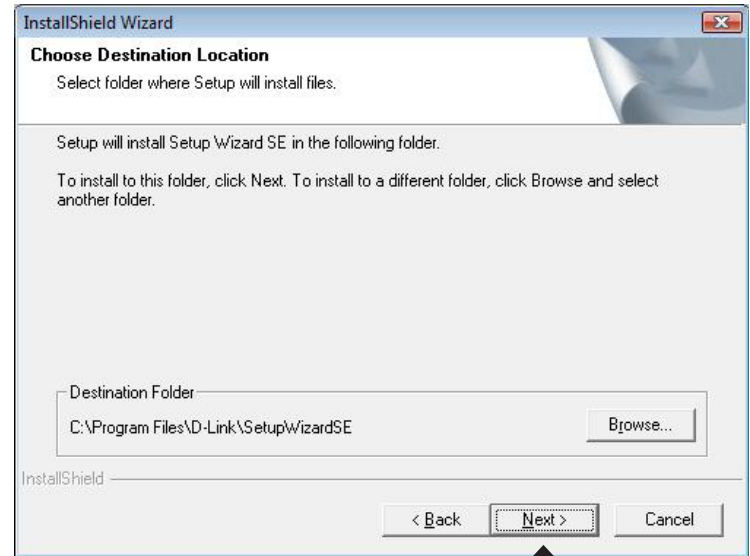

Click **Finish** to complete the installation.

Click **Finish**

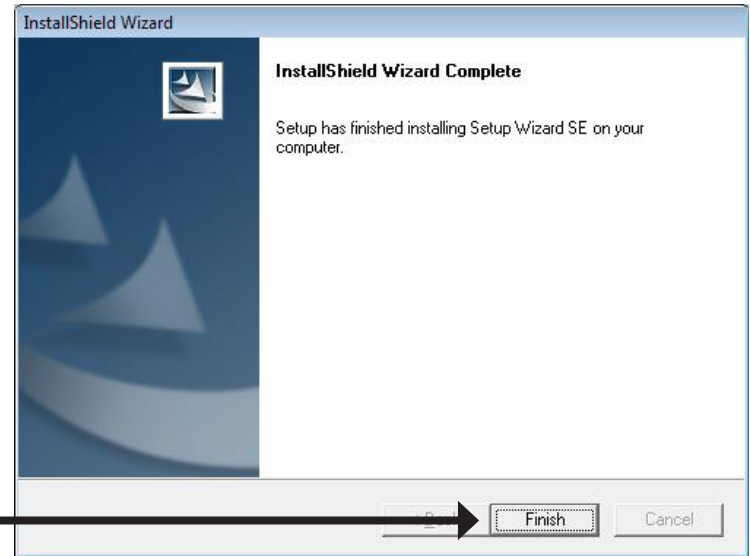

Click **ffdshow** from the autorun screen to install the proper codecs that will allow you to playback videos taken by the DCS-7410.

Click **ffdshow**



Click **I Agree**

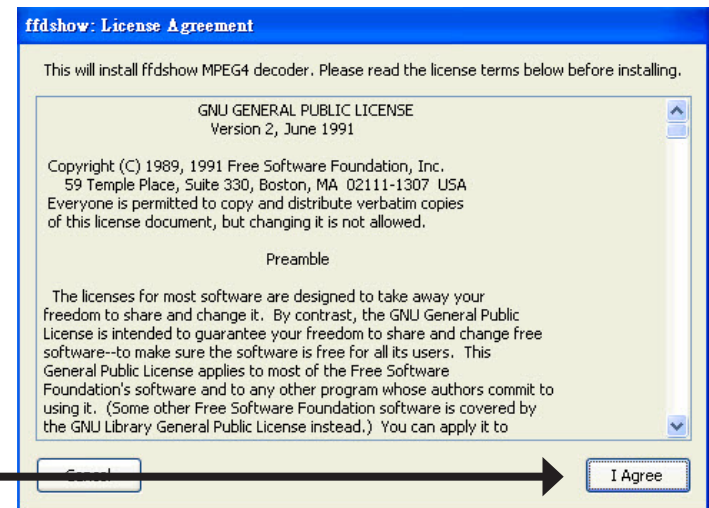

Select Language, and then click **OK**

Click **OK**

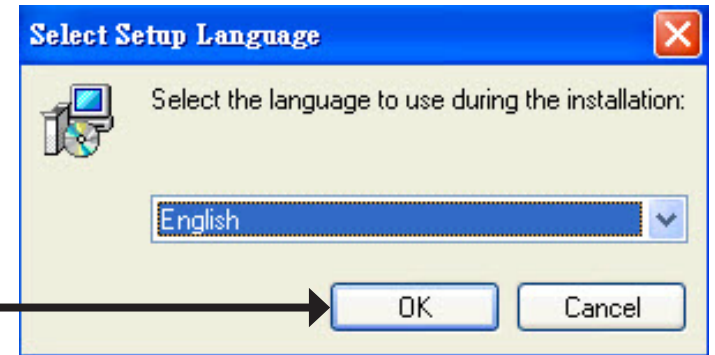

Select Language, and then click **OK**

Click **Next**

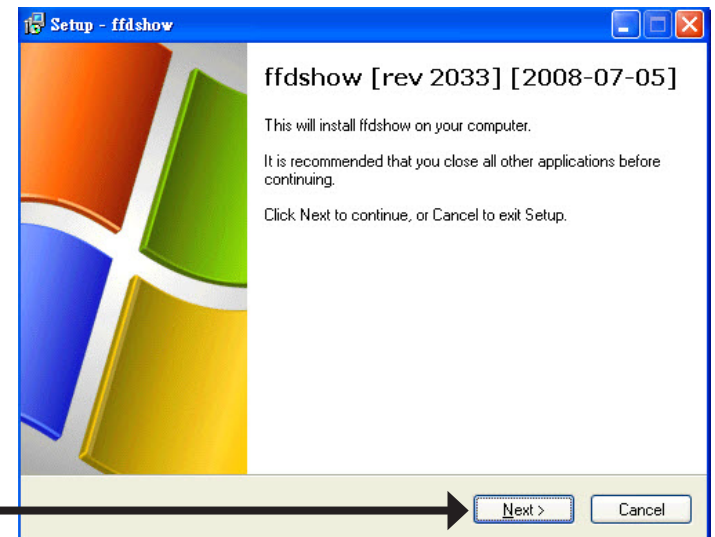

Click Next

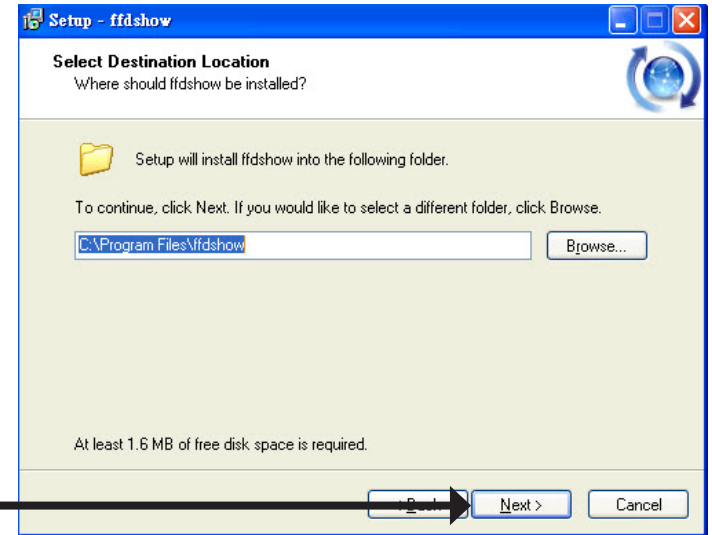

Click Next

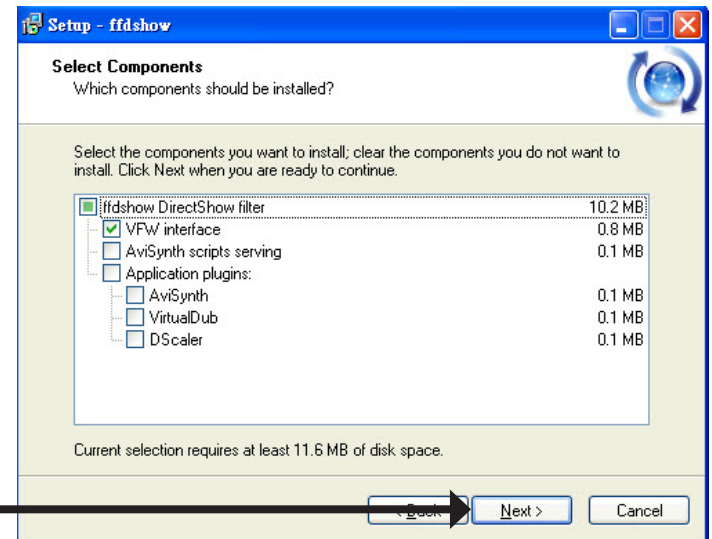



Click **Next**

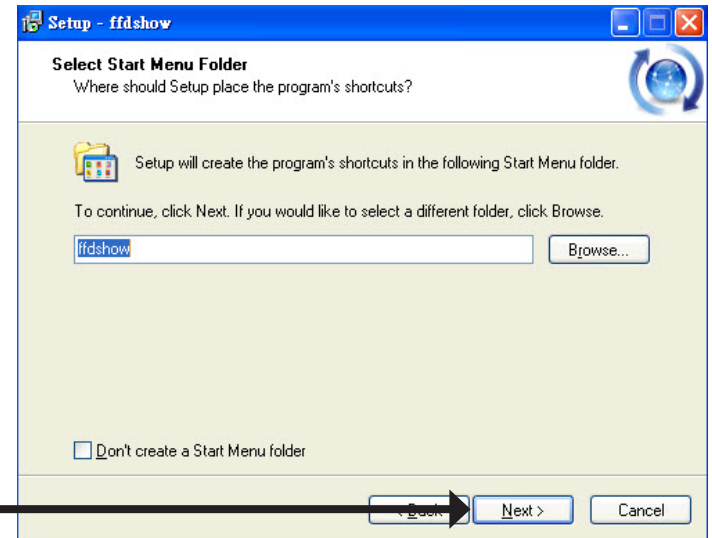

Click **Next**

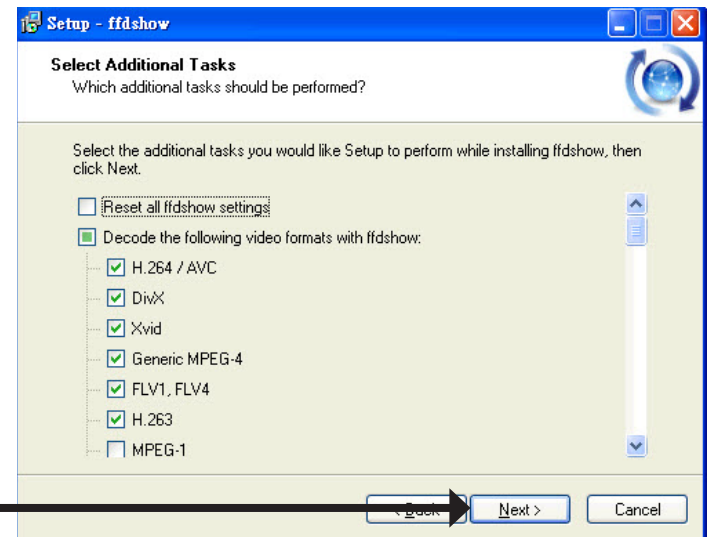

Click Next

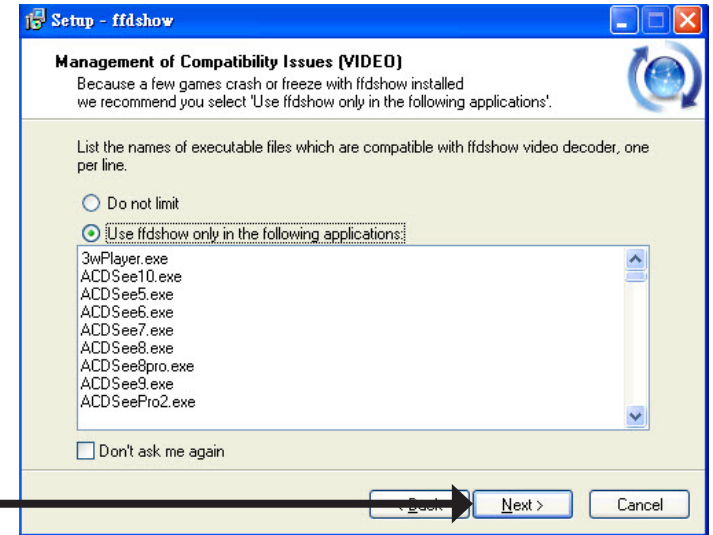

Click Next

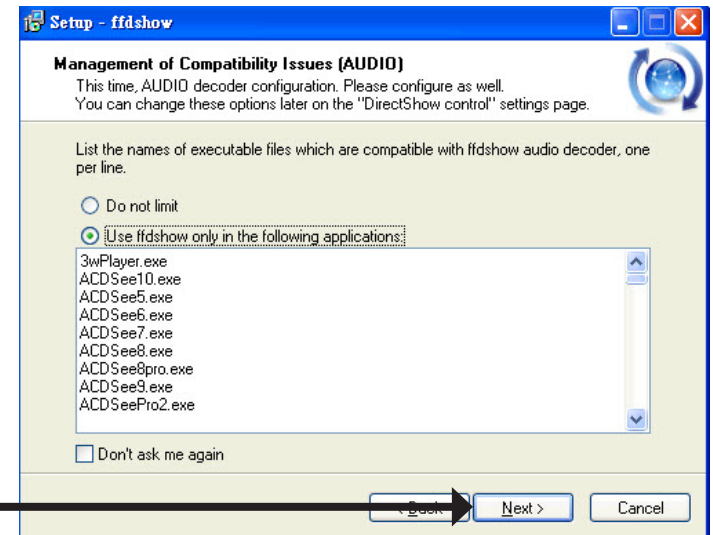

Select the speaker from your PC, and then click **Next**

Click **Next**

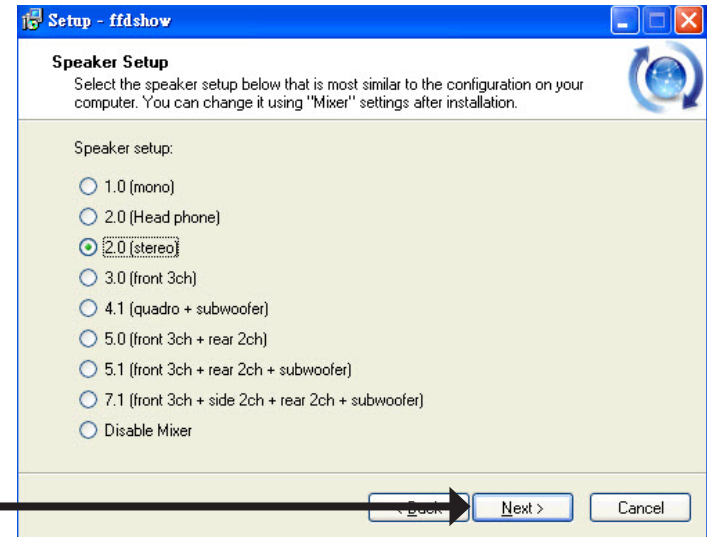

Click **Install**

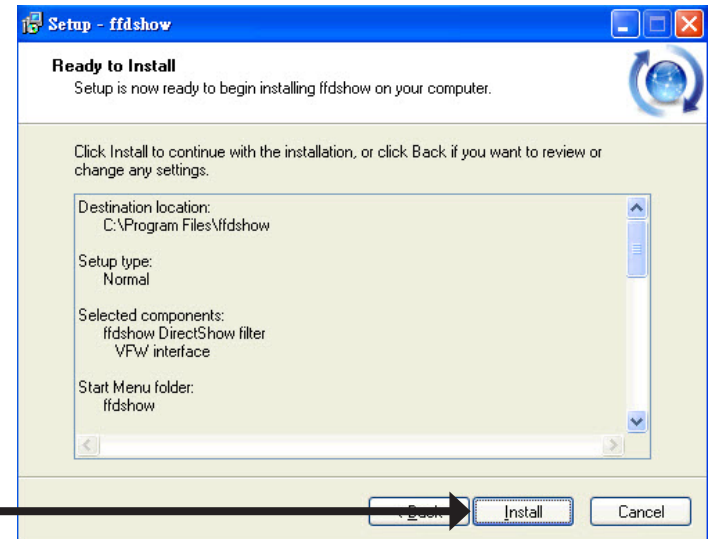

## Installing

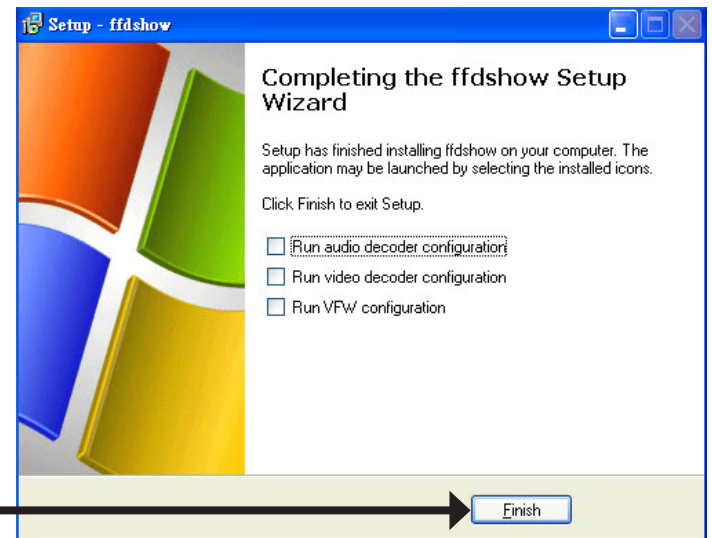
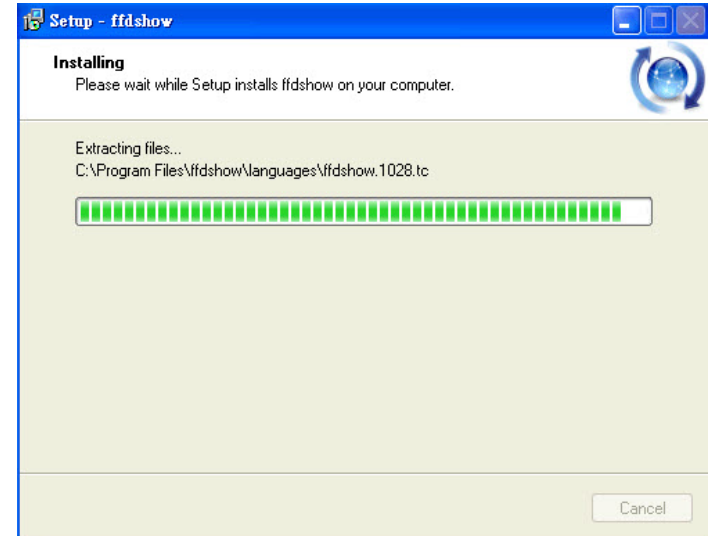

Click **Finish**



# Configuration

This section will help you configure your new D-Link Network Camera using the **Setup Wizard**.

## Using the Setup Wizard

Click the **D-Link Setup Wizard SE** icon that was created in your **Windows Start** menu.

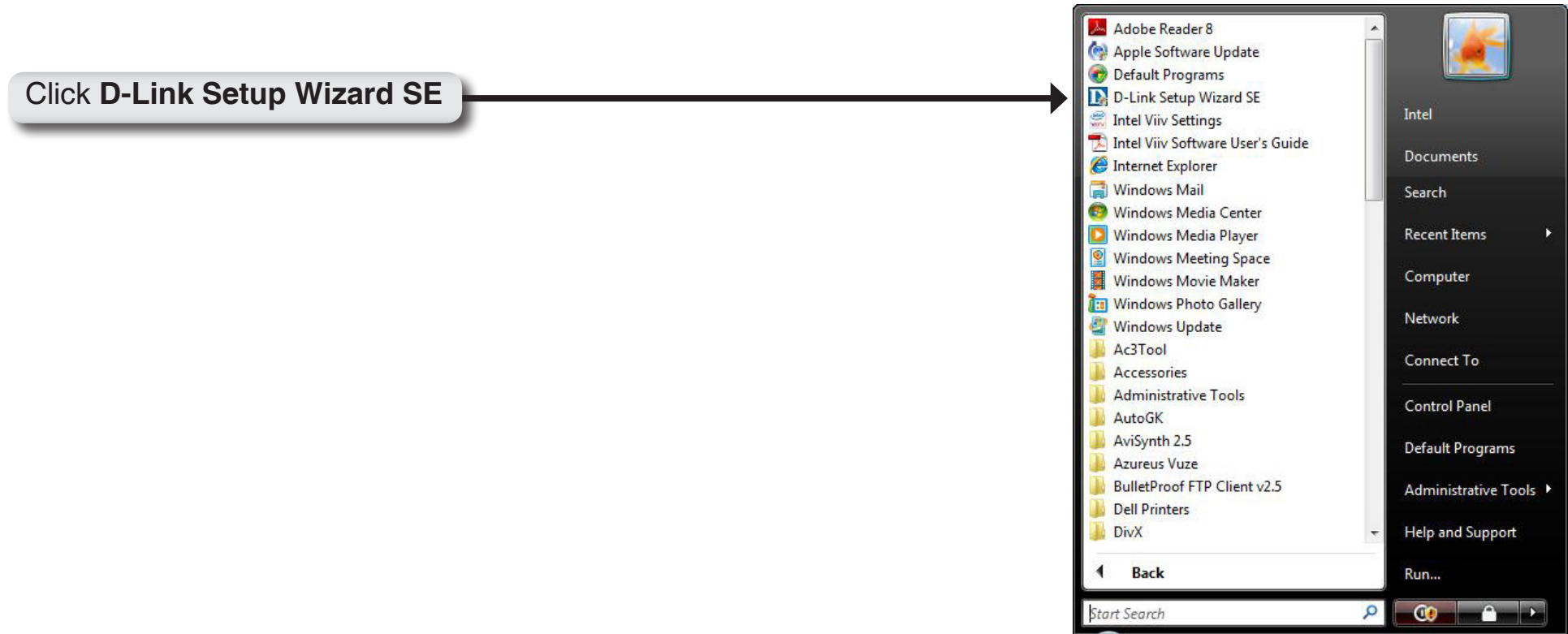

The **Setup Wizard** will display the MAC address of the DCS-7410 and an IP Address (which may or may not be correct depending on your DCS-7410 connection). If you have a DHCP server on your network, there will be a valid IP Address displayed here. Click the **Wizard** button to continue.



Enter the admin ID and password.

**Note:** The default Admin ID is **admin** with the password left blank.



Click Next

Select **DHCP** if you want to get an IP address automatically from your router or Internet service.

Click **Next** to continue.



Click **Next**

Alternatively, you can select **Static IP** to use the same IP address on camera start up.

Click **Next** to continue.



Click **Next**

Click **Restart** to save your settings and reboot your Network Camera.



Click **Restart**



Click **Link** to access the web configuration page. The **Setup Wizard** will automatically open your web browser and enter the IP address of your camera into a web browser.

In this example, the IP address is **http://192.168.1.185**. Your DCS-7410 may have a different IP address.

Click **Link**





# Using the Configuration Menu

After completing the Camera Installation Wizard, you are ready to use your camera. The camera's built-in Web configuration utility is designed to allow you to easily access and configure your DCS-7410. At the end of the Setup Wizard, click **Go To Camera**, or enter the IP address of your camera into a web browser, such as Internet Explorer. To log in, use the User name **admin** and the password you created in the Installation Wizard. If you did not create a password, leave the password text box blank. After entering your password, click **OK**.

**Note:** If you are directly connecting your PC to the camera, or if you are using the camera on a closed network, the default IP is 192.168.0.20.

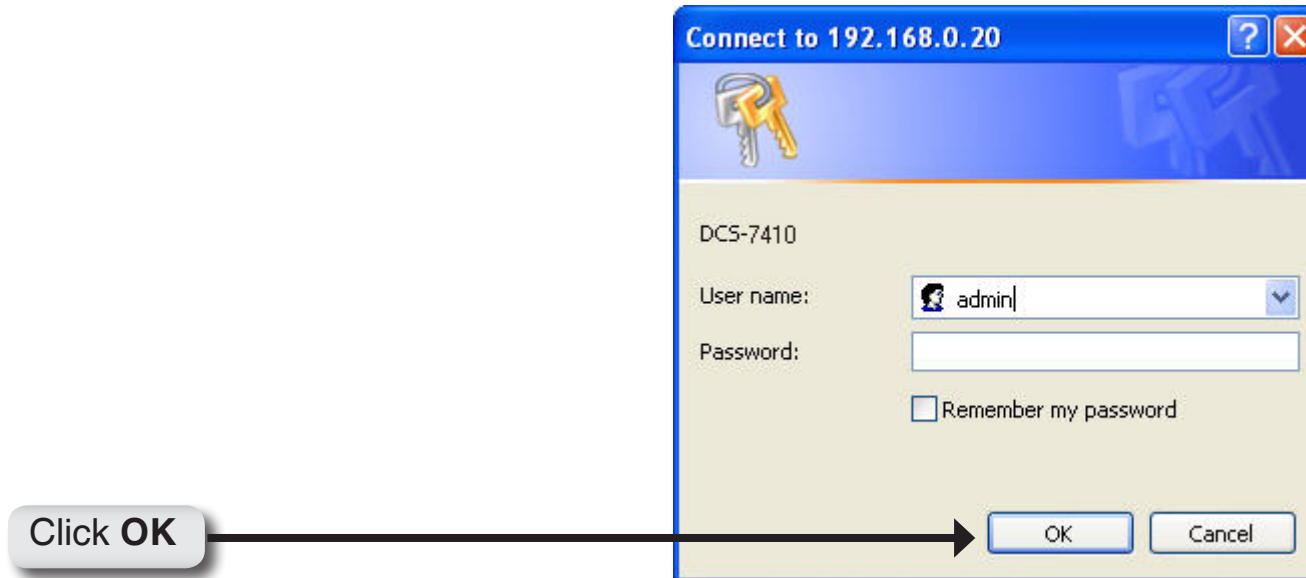

# Web-based Configuration Utility

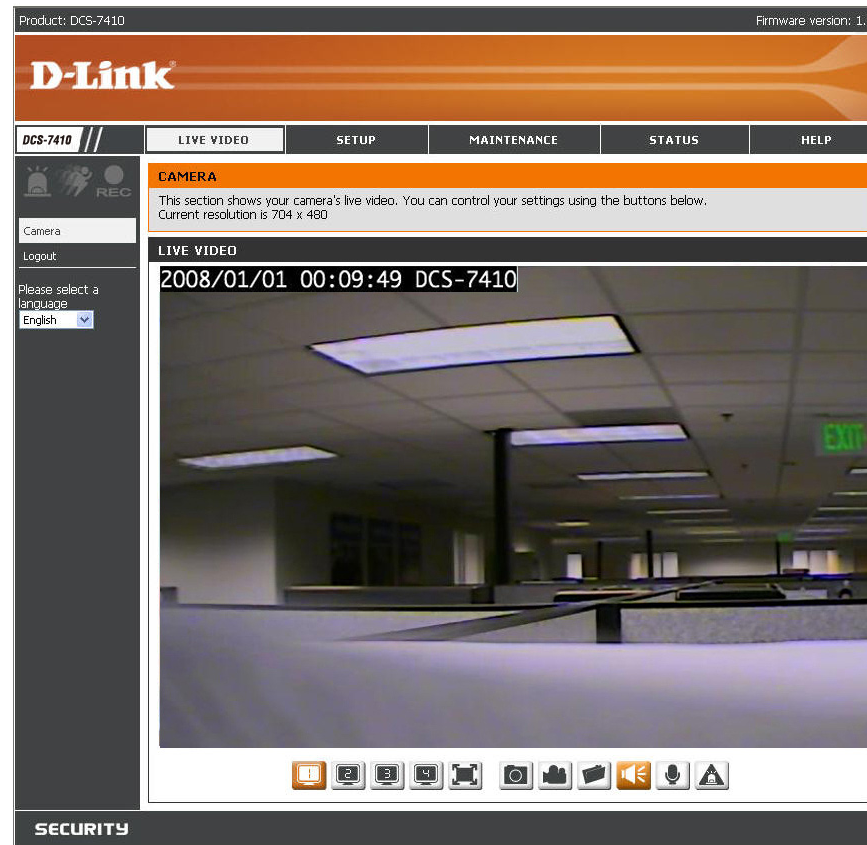

Use the following sections to set up and configure your network camera:

- LIVE VIDEO
- SETUP
- MAINTENANCE
- STATUS
- HELP

# Live Video

## LIVE VIDEO > Camera

This section shows your camera's live video and event indicators. You can zoom in and out of the live video image using your mouse. Left-click to zoom in and right-click to zoom out on the image.

You may also select your language setting using the drop-down menu.



**Digital Input** This indicator will light up, when there is an available digital input signal.









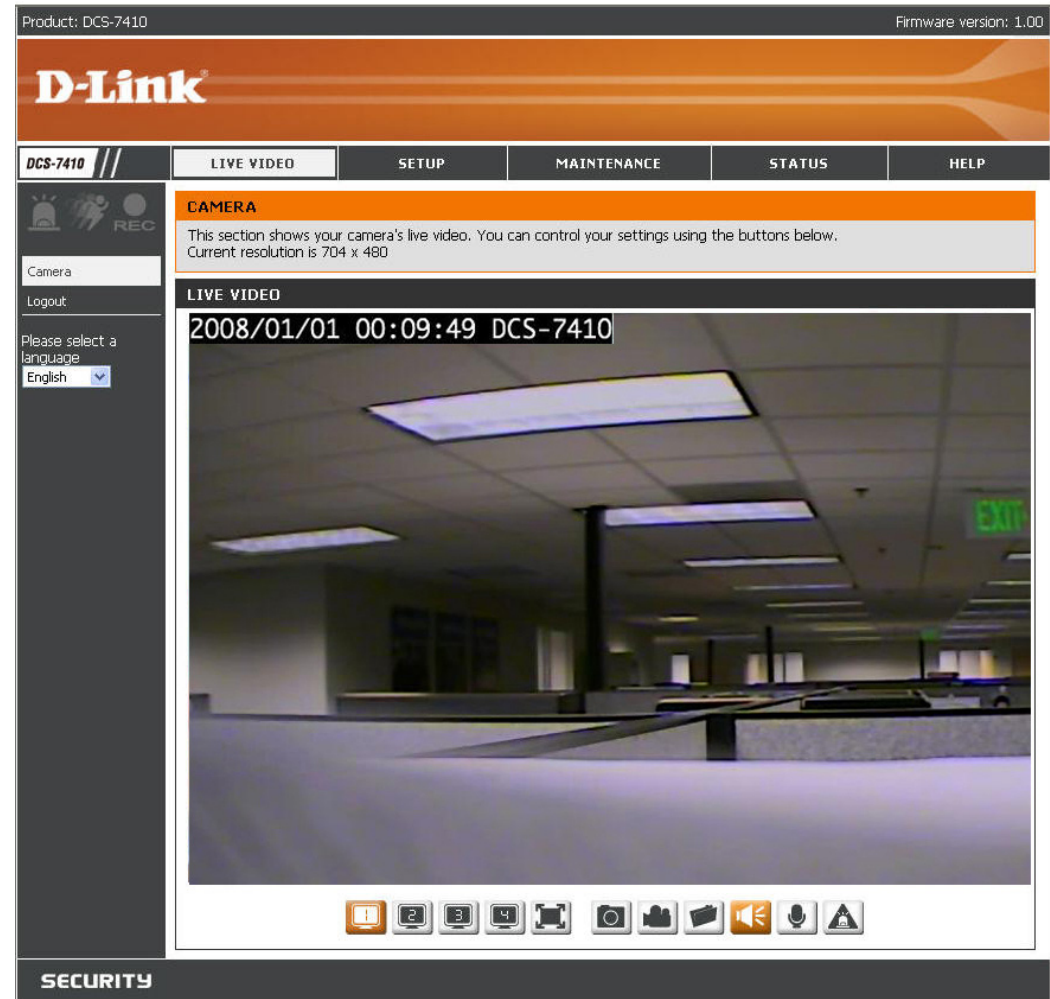

**Motion Trigger** This indicator will light up, when an event is triggered.  
**Note:** Ensure that the video motion feature of your camera is enabled.



**Recording** This indicator will light up, when a recording is in progress.



You can access various functions by clicking on the buttons at the bottom of the window:

-  **Video Profile:** There are four different viewing profiles, which you can configure in **Setup > Audio and Video**.
-  **Full Screen:** This allows you to view the video in full screen mode. To exit full screen mode, press the **ESC** key on your keyboard.
-  **Snapshot:** Click to capture a snapshot image. The image will pop up in a new window. You may save this image to a local hard drive.
-  **Record Video:** Clicking this button will start or stop recording video to the file path specified with the **Set Storage Folder** button.
-  **Set Storage Folder:** You can change the folder where the video recordings will be saved.
-  **Start/Stop Audio:** This button toggles the microphone on and off, allowing you to hear audio from the area surrounding your camera.
-  **Start/Stop Talking:** This button toggles the speaker on and off, allowing you to talk with others near your camera.
-  **Start/Stop Digital Output:** This will toggle the GP DO output on and off.

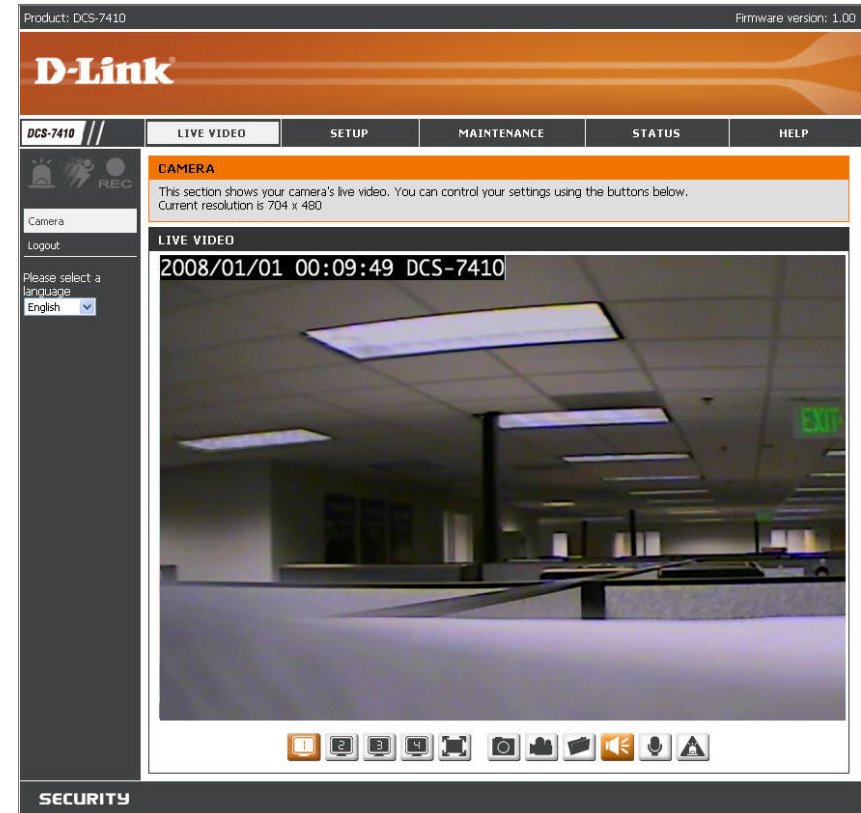

# Setup

## SETUP > Setup Wizard

The setup wizard guides you through the initial setup of your IP camera. You can use the **Internet Connection Setup Wizard** for initial network setup, and you can use the **Motion Detection Setup Wizard** to set up motion detection and snapshots. Simply follow the instructions given in each step of the wizard to quickly set up your camera.

Alternatively, you can manually set up your Internet connection by clicking **Manual Internet Connection Setup**, and you can manually set up motion detection options by clicking on **Manual Motion Detection Setup**. You can also see these settings by clicking on the menu on the left panel (**Network Setup / Motion Detection / Snapshot**).



## Internet Connection Setup Wizard

This wizard will guide you through a step-by-step process to configure your LAN and Internet configuration.

Click **Next** to continue.

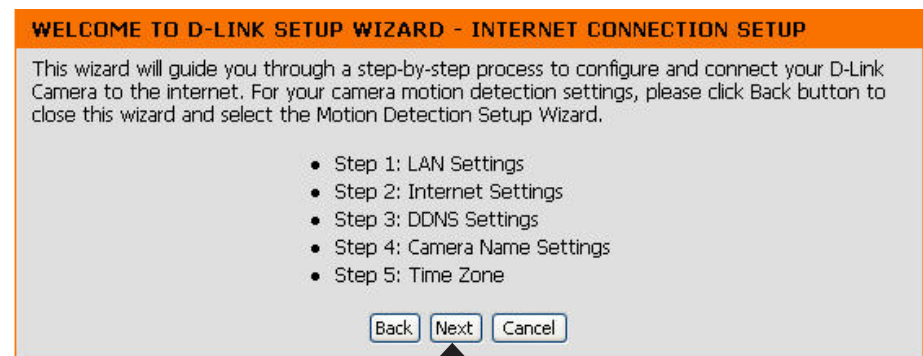

Click **Next**

Select **DHCP** if you are not sure which LAN settings to use. This allows your camera to get an IP address automatically from your router or Internet service.

**STEP 1: LAN SETTINGS**

Please select whether your camera will connect to the Internet with a DHCP connection or Static IP address. If your camera is connected to a router, or you are unsure which settings to pick, D-Link recommends that you keep the default selection of DHCP connection. Otherwise, select Static IP address to manually assign an IP address before clicking on the Next button.

DHCP Connection  
 Static IP Address

IP Address: 192.168.0.20  
Subnet Mask: 255.255.255.0  
Default Gateway: 192.168.0.1  
Primary DNS:   
Secondary DNS:

Back Next Cancel

Click Next



Select **Static IP** to manually set the IP address information of your camera.

**STEP 1: LAN SETTINGS**

Please select whether your camera will connect to the Internet with a DHCP connection or Static IP address. If your camera is connected to a router, or you are unsure which settings to pick, D-Link recommends that you keep the default selection of DHCP connection. Otherwise, select Static IP address to manually assign an IP address before clicking on the Next button.

DHCP Connection  
 Static IP Address

IP Address: 192.168.0.20  
Subnet Mask: 255.255.255.0  
Default Gateway: 192.168.0.1  
Primary DNS:   
Secondary DNS:

Back Next Cancel

Click Next



If you are using a PPPoE connection, check **Enabled** and enter the **Username** and **Password** for your PPPoE account. You can get this information from your Internet service provider (ISP).

Click **Next**

#### STEP 2: INTERNET SETTINGS

If your ISP is using PPPoE, please enable this setting and enter your ISP Username and Password. Then, click on the Next button. Please contact your ISP if you do not know your Username and Password.

Enabled

Username   
(e.g. 123456@hinet.net)

Password

If you have a Dynamic DNS account and would like the camera to update your IP address automatically, select **Enable** and enter your host information.

Click **Next**

#### STEP 3: DDNS SETTINGS

If you have a Dynamic DNS account and would like the camera to update the IP address automatically, please enable DDNS and enter your host information below. Then, click on the Next button to continue.

Sign up for D-Link's Free DDNS service at [www.DlinkDDNS.com](http://www.DlinkDDNS.com).

Enable

Server Address  <<

Host Name

User Name

Password

Verify Password

Timeout  (Hours)

Enter a name for your camera and click **Next** to continue.

Click **Next**

#### STEP 4: CAMERA NAME SETTINGS

D-Link recommends that you rename your camera for easy accessibility. You can then identify and connect to your camera via this name. Please assign a name of your choice before clicking on the Next button.

Camera Name

Configure the time to ensure that all events are triggered, captured and scheduled at the right time. Click **Next** to continue.

**STEP 5: TIME ZONE**

Please configure the correct time to ensure that all events are triggered, captured and scheduled at the right time. Then, click on the Next button.

Time Zone: (GMT-12:00) International Date Line West

Enable Daylight Saving

Auto Daylight Saving

Set date and time manually

Offset: +1:00

Start time	Month	Week	Day of week	Hour	Minutes
	3	2	Sunday	2	00
End time	11	1	Sunday	2	00

Back Next Cancel

Click **Next**

If you selected **DHCP** mode, you will see the following screen appear. Please note down this information in order to access your camera on the network. Click **Apply** to save your settings.

**STEP 6: SETUP COMPLETE**

Below is a summary of your camera settings. Click on the Back button to review or modify settings or click on the Apply button if all settings are correct. It is recommended to note down these settings in order to access your camera on the network or via your web browser.

IP Address	DHCP
IP Camera Name	DCS-7410
Time Zone	(GMT-12:00) International Date Line West
DDNS	Disable
PPPoE	Enable

Back Apply Cancel

Click **Apply**

If you selected **Static IP** mode, you will see the following screen appear. Please note down this information in order to access your camera on the network. Click **Apply** to save your settings.

**STEP 6: SETUP COMPLETE**

Below is a summary of your camera settings. Click on the Back button to review or modify settings or click on the Apply button if all settings are correct. It is recommended to note down these settings in order to access your camera on the network or via your web browser.

IP Address	DHCP
IP Camera Name	DCS-7410
Time Zone	(GMT-12:00) International Date Line West
DDNS	Disable
PPPoE	Enable

Back Apply Cancel

Click **Apply**



## Motion Detection Setup Wizard

This wizard will guide you through a step-by-step process to set up **Motion Detection** on your IP camera. Click **Next** to continue.

### WELCOME TO D-LINK SETUP WIZARD - MOTION DETECTION

This wizard will guide you through a step-by-step process to configure your camera's motion detection functions. To setup the camera LAN or Internet settings, please click on the Back button to close this wizard and re-open the Internet Connection Setup Wizard. Otherwise click on the Next button to begin.

- Step 1: Specify Motion Detection Area Settings
- Step 2: Alerts and Notifications

Back Next Cancel

Click Next

This step allows you to enable or disable video motion and control the sensitivity of your camera.

To draw a motion detection zone, select **Draw motion area**, then click and drag your mouse over the areas of the image you want to monitor for motion detection. You can select **Erase motion area** to remove areas, and you can also enter a **Sensitivity** for motion detection, where 0% is the least sensitive setting and 100% is the most sensitive setting. Click **Next** to continue.

### STEP 1: SPECIFY MOTION DETECTION AREA SETTINGS

This section will allow you to enable or disable motion detection function, draw or erase motion area, as well as configure the sensitivity setting of your camera to detect movement.

Enable Video Motion

2008/01/01 00:21:52 DCS-7410



Sensitivity

90 0~100%

Drawing Mode

Draw motion area

Erase motion area

Clear

Back Next Cancel

Click Next

This step allows you to specify how event notifications are sent from your camera, either through e-mail or FTP. Make sure you enter all the relevant information for your e-mail account or FTP server. Click **Next** to continue.

**STEP 2: ALERTS AND NOTIFICATIONS**

This final step allows you to specify how you will receive alert and notification of camera events. You can enable an email notification and/or a FTP Notification by input all the relevant information. Then, click on the Next button.

Enable e-mail notification

User Name

Password

SMTP Mail Server

Sender E-mail Address

Recipient E-mail Address

Port  (range 1 to 65535)

Enable FTP uploading

User Name

Password

Host Name

Path

Filename Prefix

Port  (range 1 to 65535)

Interval  Seconds (range 1 to 86400 seconds)

Passive Mode

Click **Next**



You have completed the **Motion Detection Wizard**.  
Click **Apply** to activate your settings.

**STEP 3: SETUP COMPLETE**

You have completed your camera setup. Please click the Back button if you want to review or modify your settings or click on the Apply button to save and apply your settings.

Motion Detection: Enable  
Alerts and Notification: Do not notify me

Click **Apply**



# SETUP > Network Setup

**Network Setup** allows you to configure your LAN and Internet settings.

**DHCP:** Select this to allow your camera to get an IP address automatically from your router or Internet service. If you are not sure which LAN settings to use, try using DHCP mode first.

**Connection:** Select this to manually set the IP address information for your camera.

**Static IP Address:** Enter the IP address the camera should use.

**IP Address:** The fixed IP address.

**Subnet Mask:** Enter the subnet mask that the camera should use. The default value is "255.255.255.0". This option is used to determine if the destination is in the same subnet.

**Default Gateway:** Enter the default gateway that the camera should use. The gateway is used to forward frames to destinations in a different subnet. Invalid gateway settings may cause transmission failure.

**Primary DNS:** Enter the IP address of the primary DNS server that the camera should use. The primary DNS translates domain names to IP addresses.

**Secondary DNS:** Enter the IP address of the secondary DNS server that the camera should use. The secondary DNS is used as a backup for the primary server.

**Note:** If you need to use a static IP address and you do not know the network information, contact your Internet Service Provider (ISP) for assistance.

Product: DCS-7410 Firmware version: 1.00

**D-Link**

DCS-7410 // LIVE VIDEO SETUP MAINTENANCE STATUS HELP

Setup Wizard  
Network Setup  
Dynamic DNS  
Image Setup  
Audio and Video  
Motion Detection  
Time and Date  
Recording  
Snapshot  
Digital Output  
RS-485  
Logout

**NETWORK SETUP**  
You can configure your LAN and Internet settings here.  
Save Settings Don't Save Settings

**LAN SETTINGS**

LAN

DHCP Connection  
 Static IP Address

IP Address   
Subnet Mask   
Default Gateway   
Primary DNS   
Secondary DNS

Enable UPnP  
 Enable UPnP port forwarding

External HTTP port   
External RTSP port

Enable PPPoE

User Name   
Password   
Confirm password

**PORT DETAIL SETTINGS**

HTTP port   
RTSP port   
 User authentication

Save Settings Don't Save Settings

**SECURITY**

**Helpful Hints..**  
Select 'DHCP Connection' if you are running a DHCP server on your network and would like an IP address assigned to your camera automatically.  
- 'Enabling UPnP' settings will allow you to configure your camera as an UPnP device in the network.  
- 'Port Detail Settings' allow you to specify the ports you reserve for both HTTP and RTSP Streaming.  
- 'HTTP Port' is the port you allocate in order to connect to the camera via a standard web browser.  
- 'RTSP Port' is the port you allocate in order to connect to a camera by using streaming mobile device(s), such as a mobile phone or PDA.

**Enable UPnP:** Universal Plug & Play (UPnP) allows Windows PCs to find this camera under “Network Neighborhood” without configuration.

**Enable UPnP port forwarding:** Enables your camera to add port forwarding entries into the router automatically.

**Enable PPPoE:** Select this option if you are using a PPPoE service and enter the **User Name** and **Password** for your PPPoE account. You can get this information from your Internet service provider (ISP).

**HTTP port:** This is the port that allows the user to connect to the camera’s user interface. By default the port is set to 80. You may change the port number if using multiple cameras.

**RTSP port:** This is the port that you use for RTSP streaming to mobile devices or PDAs. By default the port is set to 554. You may change the port number if using multiple cameras.



Click **Save Settings** to save your changes, or click **Don’t Save Settings** to discard your changes.

**Note:** Make sure you set up your router/gateway for Port Forwarding/Mapping; this will enable remote viewing of your camera via the Internet. Please refer to your router’s instruction manual on how to forward ports.

## SETUP > Dynamic DNS

If you have a DSL or Cable service provider that changes your modem IP address periodically, Dynamic DNS (Domain Name System - a method of keeping a domain name linked to a dynamic IP address) is useful. With the DCS-7410, you can set up your DDNS service and the camera will automatically update your DDNS server every time it receives a different IP address. Depending on the service, this update may take up to a few hours.

**Enable DDNS:** Select to enable the DDNS function of the camera.

**Server Address:** Select a DDNS service provider from the drop-down box or manually enter your server address.

**Host Name:** Enter the Host Name of the DDNS service.

**User name:** Enter your User Name for the DDNS service.

**Password:** Enter the password for the DDNS service.

**Verify Password:** Re type the password for the DDNS service.

**Timeout:** This sets the number of hours between DDNS updates.

**Status:** Indicates the current connection status of your camera to your DDNS service.

Product: DCS-7410 Firmware version: 1.00

**D-Link**

DCS-7410 // LIVE VIDEO SETUP MAINTENANCE STATUS HELP

Setup Wizard  
Network Setup  
Dynamic DNS  
Image Setup  
Audio and Video  
Motion Detection  
Time and Date  
Recording  
Snapshot  
Digital Output  
RS-485  
Logout

**DYNAMIC DNS**

The Dynamic DNS feature allows you to use a domain name that you have purchased (www.yourdomain.com) to access your camera with a dynamically assigned IP address. Most broadband Internet service providers assign dynamic (changing) IP addresses. By using a DDNS service, you can enter your domain name to connect to your camera no matter what your IP address is.

[Sign up for D-Link's Free DDNS service at www.DLinkDDNS.com.](http://www.DLinkDDNS.com)

Save Settings Don't Save Settings

**DYNAMIC DNS SETTING**

Enable DDNS

Server Address  << Select Dynamic DNS Server

Host Name

User Name

Password

Verify Password

Timeout  (hours)

Status: Disable

Save Settings Don't Save Settings

**Helpful Hints..**

Dynamic DNS is useful if you have a DSL or Cable service provider that changes your modem IP address periodically. This will allow you to assign a website domain name to your camera instead of connecting through an IP address.

**SECURITY**

Click **Save Settings** to save your changes, or click **Don't Save Settings** to discard your changes.

## SETUP > Image Setup

**Image Setup** allows you to adjust the settings for your video image. A preview of this image will be shown in the live video window in the middle of the screen.

**Brightness:** This adjusts the brightness of the camera image.

**Saturation:** This adjusts the color saturation of the camera image.

**Contrast:** This adjusts the contrast of the camera image.

**Hue:** This adjusts the color tone of the camera image.

Click **Reset to Default** to reset your settings.

Product: DCS-7410 Firmware version: 1.00

**D-Link**

DCS-7410 // LIVE VIDEO SETUP MAINTENANCE STATUS HELP

Setup Wizard  
Network Setup  
Dynamic DNS  
Image Setup  
Audio and Video  
Motion Detection  
Time and Date  
Recording  
Snapshot  
Digital Output  
RS-485  
Logout

**IMAGE SETUP**

Your changes made for the image settings will be reflected immediately. The results can be seen and found in the Live Video window below.

**LIVE VIDEO**

2008/01/01 00:27:28 DCS-7410

**IMAGE SETTINGS**

Brightness 50 Saturation 50  
Contrast 50 Hue 50

Reset to Default

**SECURITY**

**Helpful Hints..**

Brightness, Contrast, Saturation, and Hue can be adjusted from 0 to 100, allowing you to fine-tune your image settings.

**Brightness** - It is used to compensate for backlit scenes.

**Saturation** - It controls the strength of color from black and white to bold colors.

**Contrast** - Adjustable to control the contrast of colors between the object. It help to improve the image under a dull grey sky.

**Hue** - Is the gradation of color.

## SETUP > Audio and Video

**Audio and Video** allows you to configure four video profiles with different settings for your camera. You may also set up different profiles for your computer and mobile display. In addition, you may configure the audio (speakers and microphone) settings for your camera.

**Encode Type:** This sets the video codec used for the video stream. You can choose MPEG-4 or MJPEG (JPEG). Internet Explorer browsers can view both MPEG-4 and MJPEG video streams, and non-IE browsers can only view MJPEG video streams.

**Resolution:** This sets the display resolution of the video stream. The following options are:

- QQVGA@176x120 - Usually set for handheld devices.
- QVGA 352x240 - Standard setting for viewing from mobile phones and PDAs.
- VGA@704x480 - Standard setting for viewing from a PC.

**FPS:** This sets the target number of Frames Per Second (FPS) for the video stream. Higher frame rates will provide smoother video.

**BPS:** This sets the target bitrate of the video stream. Higher bitrates will provide better quality video.

**JPEG Quality:** This sets the JPEG quality of any manual snapshots you take when this video profile is selected.

Product: DCS-7410 Firmware version: 1.00

**D-Link**

DCS-7410 // LIVE VIDEO SETUP MAINTENANCE STATUS HELP

Setup Wizard  
Network Setup  
Dynamic DNS  
Image Setup  
Audio and Video  
Motion Detection  
Time and Date  
Recording  
Snapshot  
Digital Output  
RS-485  
Logout

### AUDIO AND VIDEO

You may configure audio, and video settings (4 video profiles) here. Profile 3 has been set as the for snapshot while profile 4 is set for your mobile phone or PDA device.

Save Settings Don't Save Settings

#### VIDEO PROFILE 1

Encode Type	Resolution	FPS	bps	JPEG Quality	RTSP URL
MPEG4	704x480	30	2 Mbps	Good	play1.sdp

#### VIDEO PROFILE 2

Encode Type	Resolution	FPS	bps	JPEG Quality	RTSP URL
MPEG4	704x480	10	768 Kbps	Good	play2.sdp

#### VIDEO PROFILE 3

Encode Type	Resolution	FPS	bps	JPEG Quality	RTSP URL
JPEG	704x480	10	--	Good	play3.sdp

#### VIDEO PROFILE 4 FOR MOBILE DEVICE ONLY

Encode Type	Resolution	FPS	bps	JPEG Quality	RTSP URL
MPEG4	176x120	5	64 kbps	--	3gpp

#### AUDIO SETUP

Enable Speaker

Volume 50

Enable Microphone

Volume 50

Save Settings Don't Save Settings

### Helpful Hints..

**Encode Type** - Select the video codec: 'JPEG' or 'MPEG4'.

**Resolution** - 3 options depend on display system used.

**FPS (Frame per second)** - 30fps(NTSC) is the highest video quality for this camera.

**bps (bit per second)** - Select a fixed bandwidth for your camera operation. Higher value means a higher quality image but consumes more network bandwidth.

**JPEG Quality** - Set the quality of JPEG image.

**RTSP URL** - The URL used to connect to the camera when viewing from a mobile device or PDA, (i.e. rtsp://EXAMPLE.dlinkddns.com/3gpp).

**Audio Setup** - To switch the external speaker and microphone on/off or adjust the volume.

**Enable Speaker** - Enabling this feature to allow you to talk using PC's microphone and your voice to be transmitted to the external speaker connected to the camera.

**Speaker Volume** - You can adjust the speaker volume using the volume level setting.

**Enable Microphone** - Enabling this feature to hear audio from the IP Camera's microphone.

**Microphone Volume** - You can adjust the MIC Port volume using the volume level setting.

We suggest using a resolution of 176x120 (NTSC) at 5 FPS and 64k BPS to watch images on your cell phone or pda.

**SECURITY**



**RTSP URL:** This setting allows you to set a suffix for your camera's RTSP URL so you can view your camera's video with this video profile's settings. For example, if you enter "mpeg4" as your RTSP URL setting and your camera's IP is 192.160.0.20, you can view your camera's video with these settings through 192.160.0.20/mpeg4.

**Enable Speaker:** Checking this box will enable you to send audio to an external speaker (not included) attached to the external speaker jack of your camera. This will allow you to speak with another person through your camera.

**Volume:** This sets the volume level of the external speaker.

**Enable Microphone:** Checking this box will enable you to listen to audio picked up by the microphone. This will allow you to hear what is happening near your camera.

**Volume:** This sets the volume level of the incoming audio.

**Note:** Higher frame size, frame rate and bit rates will give you better video quality, but they will also require more network bandwidth. For best viewing results on a mobile phone, we suggest setting the Frame Rate to 5 fps and bps to 20 Kbps.

Product: DCS-7410 Firmware version: 1.00

**D-Link**

DCS-7410 // LIVE VIDEO SETUP MAINTENANCE STATUS HELP

Setup Wizard  
Network Setup  
Dynamic DNS  
Image Setup  
Audio and Video  
Motion Detection  
Time and Date  
Recording  
Snapshot  
Digital Output  
RS-485  
Logout

**AUDIO AND VIDEO**  
You may configure audio, and video settings (4 video profiles) here. Profile 3 has been set as the for snapshot while profile 4 is set for your mobile phone or PDA device.  
Save Settings Don't Save Settings

**VIDEO PROFILE 1**

Encode Type	Resolution	FPS	bps	JPEG Quality	RTSP URL
MPEG4	704X480	30	2 Mbps	Good	play1.sdp

**VIDEO PROFILE 2**

Encode Type	Resolution	FPS	bps	JPEG Quality	RTSP URL
MPEG4	704X480	10	768 Kbps	Good	play2.sdp

**VIDEO PROFILE 3**

Encode Type	Resolution	FPS	bps	JPEG Quality	RTSP URL
JPEG	704X480	10	--	Good	play3.sdp

**VIDEO PROFILE 4 FOR MOBILE DEVICE ONLY**

Encode Type	Resolution	FPS	bps	JPEG Quality	RTSP URL
MPEG4	176X120	5	64 Kbps	--	3gpp

**AUDIO SETUP**

Enable Speaker

Volume 50

Enable Microphone

Volume 50

Save Settings Don't Save Settings

**Helpful Hints...**

**Encode Type** - Select the video codec 'JPEG' or 'MPEG4'.

**Resolution** - 3 options depend on display system used.

**FPS (Frame per second)** - 30fps(NTSC) is the highest video quality for this camera.

**bps (bit per second)** - Select a fixed bandwidth for your camera operation. Higher value means a higher quality image but consumes more network bandwidth.

**JPEG Quality** - Set the quality of JPEG image.

**RTSP URL** - The URL used to connect to the camera when viewing from a mobile device or PDA. (i.e. rtsp://EXAMPLE.dlinkddns.com/3gpp).

**Audio Setup** - To switch the external speaker and microphone on/off or adjust the volume.

**Enable Speaker** - Enabling this feature to allow you to talk using PC's microphone and your voice to be transmitted to the external speaker connected to the camera.

**Speaker Volume** - You can adjust the speaker volume using the volume level setting.

**Enable Microphone** - Enabling this feature to hear audio from the IP Camera's microphone.

**Microphone Volume** - You can adjust the MIC Port volume using the volume level setting.

We suggest using a resolution of 176x120 (NTSC) at 5 FPS and 64k bps to watch images on your cell phone or pda.

**SECURITY**

Click the **Save Settings** to save your changes, or click **Don't Save Settings** to discard your changes.

## SETUP > Motion Detection

This option allows you to set up **Motion Detection** on your IP camera. In order to use motion detection, you must first check the **Enable Video Motion** checkbox. You can then click on the video window and draw motion detection zones by clicking and dragging your mouse. Red areas indicate areas that will be monitored for motion.

**Enable Video Motion:** Select to turn on the motion detection feature of your camera.

**Sensitivity:** This setting adjusts how sensitive the camera will be to motion, where 100% will be the most sensitive setting and 0% will be the least sensitive setting.

**Draw motion area:** Select to draw motion detection area by dragging your mouse in the window ( as indicated by the red box).

**Erase motion area:** Select to erase your motion detection area by dragging your mouse in the window.

**Clear:** Click this button to clear all motion detection areas.

Click **Save Settings** to save your changes, or click **Don't Save Settings** to discard your changes.

Product: DCS-7410 Firmware version: 1.00

**D-Link**

DCS-7410 // LIVE VIDEO SETUP MAINTENANCE STATUS HELP

Setup Wizard  
Network Setup  
Dynamic DNS  
Image Setup  
Audio and Video  
Motion Detection  
Time and Date  
Recording  
Snapshot  
Digital Output  
RS-485  
Logout

**MOTION DETECTION**

This section will allow you to enable or disable motion detection function, draw or erase motion area, as well as configure the sensitivity setting of your camera to detect movement. You must select the checkbox of 'Enable Video Motion' to turn on the feature.

Save Settings Don't Save Settings

**LIVE VIDEO**

Enable Video Motion  
2008/01/01 00:28:39 DCS-7410

Sensitivity  
90 0~100%

**Drawing Mode**

Draw motion area  
 Erase motion area

Clear

Save Settings Don't Save Settings

**Helpful Hints..**

**Sensitivity** - Set the sensitivity of camera to trigger motion detection. High sensitivity makes the motions easier to be detected.

**Draw motion area** - Drag your mouse to add motion detection range.

**Erase motion area** - Drag your mouse to erase motion detection range.

**SECURITY**

## SETUP > Time and Date

**Time and Date** allows you to configure, update and maintain the internal system clock for your camera. You can manually set your time zone from the drop-down box or automatically synchronize your time using **Network Time Protocol** (NTP) server.

**Time Zone:** Select your time zone from the drop-down menu.

**Enable Daylight Saving:** Select to enable daylight saving time.

**Auto Daylight Saving:** This option allows your camera to automatically configure the **Daylight Saving** setting.

**Set date and time manually:** Select to manually configure the **Daylight Saving** date and time.

**Offset:** Select to adjust the **Daylight Saving** offset time that will be used.

**Synchronize with NTP Server:** Select to allow the camera to automatically synchronize its clock with an NTP server.

**NTP Server:** Network Time Protocol (NTP) synchronizes the DCS-7410 with an Internet time server. Choose the one that is closest to your location.

**Set date and time manually:** Select to manually set the time and date. You can then use the drop-down boxes to select the current **Year, Month, Day, Hour, Minute, and Second.**

You can also click **Copy Your Computer's Time Settings** to automatically fill in the drop-down boxes with the current time and date from your computer.

Product: DCS-7410 Firmware version: 1.00

**D-Link**

DCS-7410 // LIVE VIDEO SETUP MAINTENANCE STATUS HELP

**TIME AND DATE**

Here you may configure the internal clock of your camera.

Save Settings Don't Save Settings

**TIME CONFIGURATION**

Time Zone (GMT-12:00) International Date Line West

Enable Daylight Saving

Auto Daylight Saving

Set date and time manually

Offset +1:00

Month Week Day of week Hour Minutes

Start time 3 2 Sunday 2 00

End time 11 1 Sunday 2 00

**AUTOMATIC TIME CONFIGURATION**

Synchronize with NTP Server

NTP Server << Select NTP Server

**SET DATE AND TIME MANUALLY**

Set date and time manually

Year 2008 Month 1 Day 1

Hour 0 Minute 29 Second 0

Copy Your Computer's Time Settings

Save Settings Don't Save Settings

**SECURITY**

**Helpful Hints..**

Setting the correct time and time zone will allow you to have accurate logs and proper scheduling for recordings.

# SETUP > Recording

**Recording** allows you to configure recording settings and scheduling.

**Enable Recording:** Select to enable the recording feature.

**Samba Auth:** Select **Anonymous** if no user name or password is required to access your Samba drive. If you require a user name and password to log in to your Samba drive, select Account and fill in the following information:

**User name:** Enter the user name required to access your Samba drive.

**Password:** Enter the password required to access your Samba drive.

**Password confirm:** Re-enter the password required to access your Samba drive for verification.

**Server:** Enter the name or the IP of the server where your Samba drive is located.

**Shared Folder:** Enter the name of your shared folder.

**Test:** Click this button to test the connection of the Samba network drive.

**Samba status:** Displays the connection status which is determined by the system. Click **Get Status** to refresh the status.

Product: DCS-7410 Firmware version: 1.00

**D-Link**

DCS-7410 // LIVE VIDEO SETUP MAINTENANCE STATUS HELP

**RECORDING**

Here you may configure and schedule the recording of your camera. You must select the checkbox of 'Enable Recording' to turn on the feature.

Save Settings Don't Save Settings

**RECORDING**

Enable recording

Record to Samba network drive:

Samba Auth Account

User name

Password

Password confirm

Server

Shared folder

Test

Samba status : Disable

Recording Options

Resolution

Record until  MB of free space is left (minimum is 32MB)

When storage is full:

Stop recording

Overwrite older recordings

Recording Method

Event Based

Motion detection triggered recording

Digital input 1 triggered recording

Digital input 2 triggered recording

Prerecord  seconds (range 0 to 15 seconds)

Postrecord  seconds (range 0 to 15 seconds)

Continuous

Scheduled

	Start	Hours	Minutes	End	Hours	Minutes
<input checked="" type="checkbox"/> Sun	Start	<input type="text" value="0"/>	<input type="text" value="0"/>	End	<input type="text" value="24"/>	<input type="text" value="0"/>
<input checked="" type="checkbox"/> Mon	Start	<input type="text" value="0"/>	<input type="text" value="0"/>	End	<input type="text" value="24"/>	<input type="text" value="0"/>
<input checked="" type="checkbox"/> Tue	Start	<input type="text" value="0"/>	<input type="text" value="0"/>	End	<input type="text" value="24"/>	<input type="text" value="0"/>
<input checked="" type="checkbox"/> Wed	Start	<input type="text" value="0"/>	<input type="text" value="0"/>	End	<input type="text" value="24"/>	<input type="text" value="0"/>
<input checked="" type="checkbox"/> Thu	Start	<input type="text" value="0"/>	<input type="text" value="0"/>	End	<input type="text" value="24"/>	<input type="text" value="0"/>
<input checked="" type="checkbox"/> Fri	Start	<input type="text" value="0"/>	<input type="text" value="0"/>	End	<input type="text" value="24"/>	<input type="text" value="0"/>
<input checked="" type="checkbox"/> Sat	Start	<input type="text" value="0"/>	<input type="text" value="0"/>	End	<input type="text" value="24"/>	<input type="text" value="0"/>

Save Settings Don't Save Settings

**Helpful Hints..**

Enable Recording will allow your camera to record the live video to a Samba network drive based on the selected events. To enable recording, select the Enable recording checkbox. Then, select a Scheduling method to specify when the camera will record the video.

## Recording Options

**Resolution:** Select the pre-defined profile you wish to use to record video.

**Record until:** Select to adjust how much free space must remain when recording. It is suggested that you set this to at least 32MB to allow for enough buffer space for the camera to record with.

**When Storage is full:** When your storage device is full or has reached the free space limit specified in **Record until**, you can choose to stop recording, or you can have the camera delete old recordings to free space for new recordings to be saved.

**Event Based:** Allow you to record video when specific events happen.

**Motion detection triggered recording:** Enabling this option will set the camera to record video when motion is detected by the camera.

**Prerecord:** Preset amount of time before motion recording is triggered.

**Postrecord:** Preset amount of time after motion recording is triggered.  
**Example:** Using motion detection triggered recording and setting Prerecord to 5 seconds and Postrecord to 9 seconds, the camera will save video from 5 seconds before motion was detected to 9 seconds after motion was detected.

**Continuous:** This will set the camera to record continuously.

**Scheduled:** Select to manually configure the start and end time for recording.

Product: DCS-7410 Firmware version: 1.00

**D-Link**

DCS-7410 // LIVE VIDEO SETUP MAINTENANCE STATUS HELP

**RECORDING**

Here you may configure and schedule the recording of you camera. You must select the checkbox of 'Enable Recording' to turn on the feature.

Save Settings Don't Save Settings

**RECORDING**

Enable recording

Record to Samba network drive:

Samba Auth Account

User name

Password

Password confirm

Server

Shared folder

Test

Samba status : Disable Get status

Recording Options

Resolution

Record until  MB of free space is left (minimum is 32MB)

When storage is full:

Stop recording

Overwrite older recordings

Recording Method

Event Based

Motion detection triggered recording

Digital input 1 triggered recording

Digital input 2 triggered recording

Prerecord  seconds (range 0 to 15 seconds)

Postrecord  seconds (range 0 to 15 seconds)

Continuous

Scheduled

		Start	Hours	Minutes	End	Hours	Minutes
<input checked="" type="checkbox"/> Sun	Start	<input type="text" value="0"/>	:	<input type="text" value="0"/>	End	<input type="text" value="24"/>	: <input type="text" value="0"/>
<input checked="" type="checkbox"/> Mon	Start	<input type="text" value="0"/>	:	<input type="text" value="0"/>	End	<input type="text" value="24"/>	: <input type="text" value="0"/>
<input checked="" type="checkbox"/> Tue	Start	<input type="text" value="0"/>	:	<input type="text" value="0"/>	End	<input type="text" value="24"/>	: <input type="text" value="0"/>
<input checked="" type="checkbox"/> Wed	Start	<input type="text" value="0"/>	:	<input type="text" value="0"/>	End	<input type="text" value="24"/>	: <input type="text" value="0"/>
<input checked="" type="checkbox"/> Thu	Start	<input type="text" value="0"/>	:	<input type="text" value="0"/>	End	<input type="text" value="24"/>	: <input type="text" value="0"/>
<input checked="" type="checkbox"/> Fri	Start	<input type="text" value="0"/>	:	<input type="text" value="0"/>	End	<input type="text" value="24"/>	: <input type="text" value="0"/>
<input checked="" type="checkbox"/> Sat	Start	<input type="text" value="0"/>	:	<input type="text" value="0"/>	End	<input type="text" value="24"/>	: <input type="text" value="0"/>

Save Settings Don't Save Settings

**Helpful Hints..**

Enable Recording will allow your camera to record the live video to a Samba network drive based on the selected events. To enable recording, select the Enable recording checkbox. Then, select a Scheduling method to specify when the camera will record the video.

Click **Save Settings** to save your changes, or click **Don't Save Settings** to discard your changes.

## Creating a Samba network drive for saving video

Follow the instructions below to create a simple Samba network drive on your Windows PC.

1. Right-click on a folder and select **Sharing and Security** and then select **Share this folder**.
2. Enter a Share name you would like to use for the folder, then click **Permissions**.
3. Check the **Full Control / Allow Everyone** group box.
4. For your camera's **Recording** settings, select **Anonymous** for the **Samba Auth**, your computer's IP address for the **Server**, and the Share name you chose for the **Shared Folder**.
5. Click **Test** to test your connection.

Click **Save Settings** to save your changes, or click **Don't Save Settings** to discard your changes.

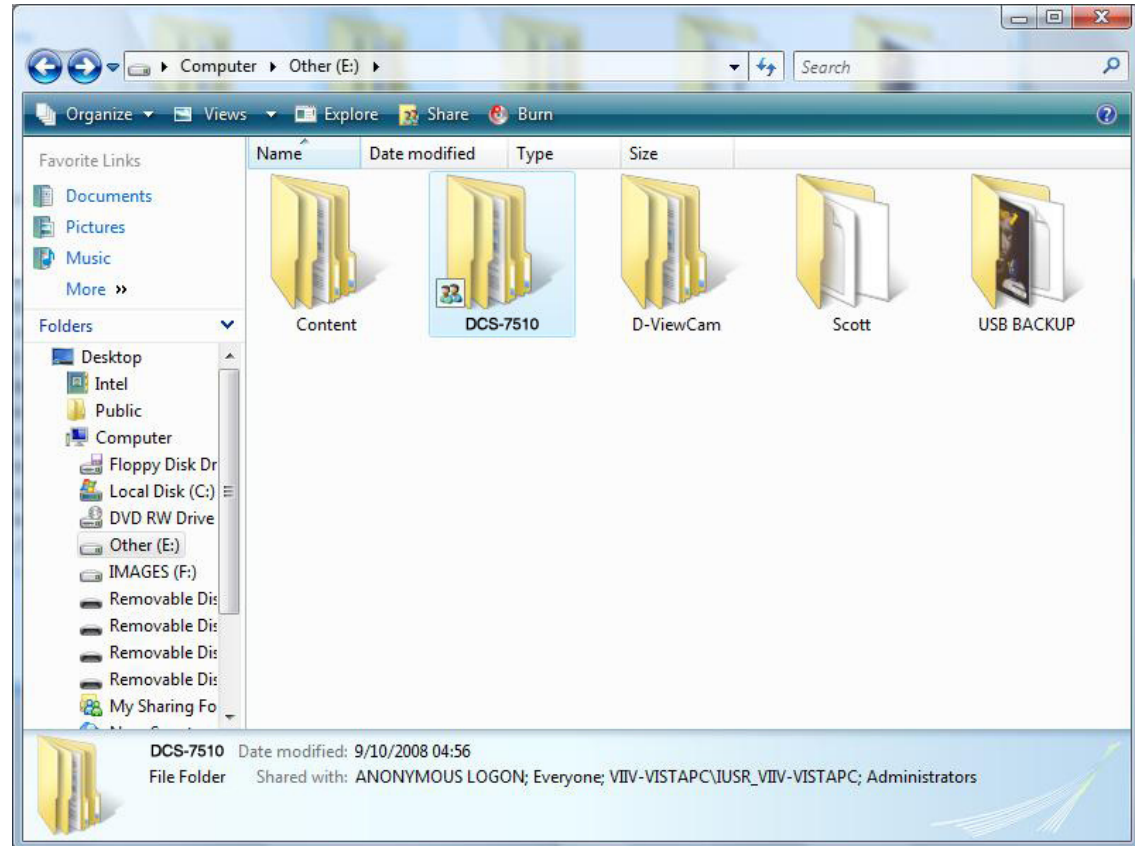

# SETUP > Snapshot

**Snapshot** enables your camera to take snapshots when motion is detected. Snapshots can be sent to an e-mail address and/or to an FTP server.

**Enable Snapshot:** Check this box to enable the snapshot feature.

**Event Based:** Select one or more events to trigger a snapshot, such as Motion Detection, D/I Signal 1 and D/I Signal 2.

**Continuous (FTP only):** This will set the camera to take snapshots continuously at intervals specified in **FTP Server > Interval** below. You can only save to an FTP server when taking continuous snapshots.

**Scheduled (FTP only):** This will set the camera to take snapshots continuously at intervals specified in **FTP Server > Interval** below according to schedule you define by checking days and entering the times you want to record between. You can only save to an FTP server when taking scheduled snapshots.

**E-mail Address:** The camera will send the snapshots to the e-mail address specified in the following text boxes. If you do not know what to enter for the **User Name**, **Password**, or **SMTP Mail Server**, contact your e-mail service provider for details.

**User Name:** Enter the username or login name for your e-mail account.

**Password:** Enter the password for your e-mail account.

**SMTP Mail Server:** Enter the SMTP server for your e-mail account.

Product: DCS-7410 Firmware version: 1.00

**D-Link**

DCS-7410 // LIVE VIDEO SETUP MAINTENANCE STATUS HELP

Setup Wizard  
Network Setup  
Dynamic DNS  
Image Setup  
Audio and Video  
Motion Detection  
Time and Date  
Recording  
Snapshot  
Digital Output  
RS-485  
Logout

**SNAPSHOT**

In order to enable your camera to take snapshots, you must select the checkbox of 'Enable Snapshot'. Then, you can determine the trigger event(s) and FTP and/or email notification(s). The resolution of snapshot can be configured as in the video profile 3 in [Audio And Video](#).

Save Settings Don't Save Settings

**SNAPSHOT**

Enable Snapshot

Scheduling

Event Based

Motion Detection

D/I Signal 1

D/I Signal 2

Continuous (FTP only)

Scheduled (FTP only)

			Hours	Minutes	Hours	Minutes
<input checked="" type="checkbox"/> Sun	Start		00	: 00	End	24 : 00
<input checked="" type="checkbox"/> Mon	Start		00	: 00	End	24 : 00
<input checked="" type="checkbox"/> Tue	Start		00	: 00	End	24 : 00
<input checked="" type="checkbox"/> Wed	Start		00	: 00	End	24 : 00
<input checked="" type="checkbox"/> Thu	Start		00	: 00	End	24 : 00
<input checked="" type="checkbox"/> Fri	Start		00	: 00	End	24 : 00
<input checked="" type="checkbox"/> Sat	Start		00	: 00	End	24 : 00

Send to:

E-mail Address

User Name

Password

SMTP Mail Server

Sender E-mail Address

Recipient E-mail Address

Port  (range 1 to 65535)

Test

FTP Server

User Name

Password

Host Name

Path

Filename Prefix

Port  (range 1 to 65535)

Interval  Seconds (range 1 to 86400 seconds)

Passive Mode

Test

Save Settings Don't Save Settings

Helpful Hints..  
You can choose to receive notifications by FTP and/or E-mail. The 'Test' buttons are provided to test if your input settings are valid and functional.

**Sender E-mail Address:** Enter the e-mail address you want to appear as the “From:” e-mail address in the snapshot e-mail.

**Recipient E-mail Address:** Enter the e-mail address you want to send your snapshots to.

**Port:** Enter the port used by your SMTP server.

**Test:** Click this button and the camera will take a snapshot and then will try to upload it to your FTP server using the settings you have entered.

**FTP Server:** When selected, the camera will send the snapshots it takes to the e-mail address specified in the text fields. If you do not know what information to enter, contact the administrator of the FTP server for details.

**Host name:** Enter the host name of your FTP account.

**Path:** Enter the directory or path where the images will be uploaded to (for example: \pub\images).

**Prefix Filename:** Enter the prefix you want to attach to your snapshot files.

**Port:** Enter the port used by the FTP server. The default port is 25.

**Passive mode:** If your FTP server requires you to use passive mode, check this box. Some FTP servers allow clients to use passive mode when connecting to an FTP. The server uses random ports for transfer.

Product: DCS-7410 Firmware version: 1.00

**D-Link**

DCS-7410 // LIVE VIDEO SETUP MAINTENANCE STATUS HELP

**SNAPSHOT**

In order to enable your camera to take snapshots, you must select the checkbox of 'Enable Snapshot'. Then, you can determine the trigger event(s) and FTP and/or email notification(s). The resolution of snapshot can be configured as in the video profile 3 in [Audio And Video](#).

Save Settings Don't Save Settings

**SNAPSHOT**

Enable Snapshot

Scheduling

Event Based

Motion Detection

D/I Signal 1

D/I Signal 2

Continuous (FTP only)

Scheduled (FTP only)

	Start	End
<input checked="" type="checkbox"/> Sun	00 : 00	24 : 00
<input checked="" type="checkbox"/> Mon	00 : 00	24 : 00
<input checked="" type="checkbox"/> Tue	00 : 00	24 : 00
<input checked="" type="checkbox"/> Wed	00 : 00	24 : 00
<input checked="" type="checkbox"/> Thu	00 : 00	24 : 00
<input checked="" type="checkbox"/> Fri	00 : 00	24 : 00
<input checked="" type="checkbox"/> Sat	00 : 00	24 : 00

Send to:

E-mail Address

User Name:

Password:

SMTP Mail Server:

Sender E-mail Address:

Recipient E-mail Address:

Port:  (range 1 to 65535)

Test

FTP Server

User Name:

Password:

Host Name:

Path:

Filename Prefix:

Port:  (range 1 to 65535)

Interval:  Seconds (range 1 to 86400 seconds)

Passive Mode:

Test

Save Settings Don't Save Settings

**Helpful Hints..**  
You can choose to receive notifications by FTP and/or E-mail. The 'Test' buttons are provided to test if your input settings are valid and functional.

Click **Save Settings** to save your changes, or click **Don't Save Settings** to discard your changes.



## SETUP > Digital Output

**Digital Output (DO)** feature enables you to configure your DO port to send signals whenever certain events occur.

**Enable D/O** This enables the D/O to send a signal when there **signal:** is a triggered event.

**Trigger Event:** Use the checkboxes to configure the camera to send a signal through the D/O port whenever motion is detected, or when a signal is detected on D/I port 1 or D/I port 2.

Click **Save Settings** to save your changes, or click **Don't Save Settings** to discard your changes.

Product: DCS-7410 Firmware version: 1.00

**D-Link**

DCS-7410 // LIVE VIDEO SETUP MAINTENANCE STATUS HELP

**DIGITAL OUTPUT**

Here you can enable your D/O port as well as how the event will be triggered.

Save Settings Don't Save Settings

**TRIGGER**

Enable D/O Signal

Trigger Event

Motion Detection

D/I Signal 1

D/I Signal 2

Save Settings Don't Save Settings

**Helpful Hints..**

You may choose a trigger event like Motion detection or triggers from the D/I port. When an event is triggered, the D/O will begin sending a signal.

**SECURITY**

## SETUP > RS-485

You may configure the **RS-485** settings or communication specifications (baud rate, data bit, stop bit, and parity bit) for your camera. RS-485 is a serial communication method for computers and devices. For your camera, RS-485 is used to control a PAN/TILT device, such as an external camera enclosure to perform PAN and TILT movement.

**Support PAN-TILT:** Once you enable this feature, a control panel will be displayed on the **Live Video** window that provides control over an external camera enclosure through the RS-485 signals.

**Protocol:** Select the protocol type from the drop-down box.

**ID:** This is the identifier for each RS-485 device. The ID range is from **1 to 255**.

**Baud Rate:** Enter the **Baud Rate** settings required by your RS-485 equipment. If you are not sure what settings to use, check your RS-485 equipment's User Manual. The default value is **2400**. The range is from **2400 to 38400** bps.

**Data Bit:** Enter the **Data Bit** settings required by your RS-485 equipment. If you are not sure what settings to use, check your RS-485 equipment's User Manual. The default value is **8**.

**Stop Bit:** Enter the **Stop Bit** settings required by your RS-485 equipment. If you are not sure what settings to use, check your RS-485 equipment's User Manual. The default value is **1**.

**Parity Bit:** Enter the **Parity Bit** settings required by your RS-485 equipment. If you are not sure what settings to use, check your RS-485 equipment's User Manual.  
For example, if the data is 011, for even parity, the parity bit is 0 to keep the number of logic-high bits even. If the parity is odd, the parity bit is 1, resulting in 3 logic-high bits.

Click **Save Settings** to save your changes, or click **Don't Save Settings** to discard your changes.

Product: DCS-7410 Firmware version: 1.00

**D-Link**

DCS-7410 // LIVE VIDEO SETUP MAINTENANCE STATUS HELP

Setup Wizard  
Network Setup  
Dynamic DNS  
Image Setup  
Audio and Video  
Motion Detection  
Time and Date  
Recording  
Snapshot  
Digital Output  
RS-485  
Logout

**RS-485**

This section enable you to specify the camera RS-485 settings.

Save Settings Don't Save Settings

**RS-485**

Support PAN-TILT

Protocol Pelco-D

ID 1 (range 1 to 255)

Baud Rate 2400

Data Bits 7 8

Stop Bit 1 2

Parity Bit No Even Odd

**Helpful Hints..**

When enabling Support PAN-TILT a control panel will be displayed on the Live Video page allowing control through RS-485 for an external camera enclosure.

**Protocol** - Select the PTZ standard used to connect a PTZ scanner via the serial interface: RS485.

**ID** - ID value is used to identify RS-485 device.

**Baud Rate** - Select the desired baud rate for the device you connected.

**Data Bits** - Select the desired data bits for the device you connected.

**Stop Bit** - Select the desired stop bits for the device you connected.

**Parity Bit** - Select the desired parity type for the device you connected.

**SECURITY**

# MAINTENANCE > Admin

Here, you can modify the Admin password and manage users. You can also use this section to configure the OSD settings for your camera.

**Admin Password Setting:** This section lets you change the admin password used to log in to the camera and adjust settings. After installing the camera for the first time, it is highly recommended that you change the admin password for security purposes.

**New Password:** Enter the new admin password.

**Retype Password:** Enter the new admin password again for verification. After entering the new password again, click **Save** to save your changes.

**Add User Account:** The admin can create user accounts to allow others to log in to your camera to view the live camera feed.

**User Name:** Enter the **User Name** you wish to use for the new user account.

**New Password:** Enter the password for the new user account.

**Retype Password:** Re-enter the password for the new user account for verification. After entering the password again, click **Add** to create the new user account.

Product: DCS-7410
Firmware version: 1.00

D-Link

DCS-7410

LIVE VIDEO

SETUP

MAINTENANCE

STATUS

HELP

Admin

System

Firmware Upgrade

Logout

ADMIN

Here you can change the administrator's password for your account as well as add and/or delete user account(s). You can also configure a unique name for your camera, and enable its OSD (On-Screen Display) feature in order to display camera name and time stamp for both live video and recordings of your camera.

ADMIN PASSWORD SETTING

New Password

30 characters maximum

Retype Password

Save

ADD USER ACCOUNT

User Name

30 characters maximum

New Password

30 characters maximum

Retype Password

Add

20 users maximum

USER LIST

User Name

-- User list --

Delete

DEVICE SETTING

Camera Name

DCS-7510

36 characters maximum

Enable OSD
 

Label

DCS-7510

30 characters maximum

Show time

LED light

On  Off

Save

SECURITY

Helpful Hints..

For security purposes, it is recommended to change the password for your administrator account. Be sure to write down the new password to avoid having to reset the camera in the event that it is forgotten.

Enabling OSD, the camera name and time will be displayed on the video screen.

**User List:** You can view the current list of users by using the drop-down box. You can also delete a user by selecting them with the drop-down box, and then clicking **Delete**.

**Device Setting:** You can change various other settings for your camera.

**Camera Name:** Create a unique name for your camera, in which you can access the camera by using this name in your web browser. For example: http://DCS-7410 (by default).

**Enable OSD:** Select to enable the On-Screen Display feature for your camera.

**Label:** This is the text label that will appear on the OSD.

**Show time:** Select to display the time-stamp on the video screen.

**LED light:** This will turn the camera's front LED indicator on or off.

Click the **Save** to save your changes.

Product: DCS-7410 Firmware version: 1.00

**D-Link**

DCS-7410 // LIVE VIDEO SETUP MAINTENANCE STATUS HELP

Admin System Firmware Upgrade Logout

**ADMIN**  
Here you can change the administrator's password for your account as well as add and/or delete user account(s). You can also configure a unique name for your camera, and enable its OSD (On-Screen Display) feature in order to display camera name and time stamp for both live video and recordings of your camera.

**ADMIN PASSWORD SETTING**  
New Password  30 characters maximum  
Retype Password

**ADD USER ACCOUNT**  
User Name  30 characters maximum  
New Password  30 characters maximum  
Retype Password   
 20 users maximum

**USER LIST**  
User Name  -- User list --

**DEVICE SETTING**  
Camera Name  DCS-7510 36 characters maximum  
 Enable OSD  
Label  DCS-7510 30 characters maximum  
Show time   
LED light  On  Off

**Helpful Hints..**  
For security purposes, it is recommended to change the password for your administrator account. Be sure to write down the new password to avoid having to reset the camera in the event that it is forgotten.  
Enabling OSD, the camera name and time will be displayed on the video screen.

**SECURITY**

## MAINTENANCE > System

This screen allows you to save and restore the camera's current configuration. You can also reset all settings to factory default or reboot the device.

**Save To Local Hard Drive:** Click **Save Configuration** to save the current configuration to a hard drive.

**Local From Local Hard Drive:** To load a saved configuration, click **Browse** to select a configuration file from your hard drive, then click **Load Configuration** to load the new configuration.

**Restore To Factory Default:** Reset your camera and restore the factory settings to your camera by clicking **Restore Factory Defaults**.

**Reboot Device:** Click this button to reboot your camera.

The screenshot displays the web interface for a D-Link DCS-7410 camera. At the top, it shows 'Product: DCS-7410' and 'Firmware version: 1.00'. The D-Link logo is prominently displayed. Below the logo is a navigation menu with tabs for 'LIVE VIDEO', 'SETUP', 'MAINTENANCE', 'STATUS', and 'HELP'. The 'MAINTENANCE' tab is selected, and the 'SYSTEM' sub-tab is active. The main content area contains the following options and buttons:

- SYSTEM** (Section Header)
- Here you may backup, restore, and reboot your camera.
- SYSTEM** (Section Header)
- Save To Local Hard Drive:
- Load From Local Hard Drive:
- Restore To Factory Defaults:
- Reboot Device:

On the right side, there is a 'Helpful Hints..' section with the text: 'After the factory's default settings have been restored, use the installation wizard software provided with your camera to search and connect to the camera.'

At the bottom of the interface, the word 'SECURITY' is displayed.

## MAINTENANCE > Firmware Upgrade

Your current firmware version and date will be displayed on this page. Here, you can also upgrade your firmware with a new version.

To upgrade your firmware, go to **support.dlink.com.tw** and download the latest firmware to your computer's hard drive. Click **Browse**, select the firmware file, then click **Upload**. While the firmware is being upgraded, do not turn off your computer or camera, and do not disconnect your network connection from your computer or camera. Upgrading the firmware will not change any of your system settings, but it is recommended that you save your system configuration before doing a firmware upgrade.

**Note:** It is recommended that you use a wired connection for your computer and camera when upgrading the firmware.

Product: DCS-7410 Firmware version: 1.00

**D-Link**

DCS-7410 // LIVE VIDEO SETUP MAINTENANCE STATUS HELP

Admin  
System  
Firmware Upgrade  
Logout

**FIRMWARE UPGRADE**

A new firmware upgrade may be available for your IP camera. It is recommended to keep your IP camera firmware up-to-date to maintain and improve the functionality and performance of your internet camera. Click here [D-Link Support Page](#) to check for the latest firmware version available.

To upgrade the firmware on your IP camera, please download and save the latest firmware version from the D-Link Support Page to your local hard drive. Locate the file on your local hard drive by clicking the Browse button. Once you have found and opened the file using the browse button, click the "Upload" button to start the firmware upgrade.

**FIRMWARE INFORMATION**

Current Firmware Version: 1.00, 2824  
Current Product Name: DCS-7410

**FIRMWARE UPGRADE**

File Path:

**Helpful Hints..**

Firmware upgrade are released periodically to improve the functionality of your IP camera and also to add new features. If you run into a problem with a specific feature of the IP camera, check our support site by clicking [here](#) to check for an upgrade and see if updated firmware is available for your IP camera.

**SECURITY**

## STATUS > Device Info

This **Device Info** screen shows you various information about your camera and its current settings.

Product: DCS-7410 Firmware version: 1.00



DCS-7410	LIVE VIDEO	SETUP	MAINTENANCE	STATUS	HELP																						
Device Info	<p><b>DEVICE INFO</b></p> <p>All of your network connection details are displayed on this page. The firmware version is also displayed here.</p> <p><b>INFORMATION</b></p> <table border="1"> <tr><td>Camera Name</td><td>DCS-7410</td></tr> <tr><td>Time &amp; Date</td><td>Tue Jan 1 00:42:24 2008</td></tr> <tr><td>Firmware Version</td><td>1.00, 2824</td></tr> <tr><td>MAC Address</td><td>00:03:1B:58:A4:01</td></tr> <tr><td>IP Address</td><td>192.168.0.20</td></tr> <tr><td>IP Subnet Mask</td><td>255.255.255.0</td></tr> <tr><td>Default Gateway</td><td>192.168.0.1</td></tr> <tr><td>Primary DNS</td><td></td></tr> <tr><td>Secondary DNS</td><td></td></tr> <tr><td>PPPoE</td><td>Failure</td></tr> <tr><td>DDNS</td><td>Disable</td></tr> </table>				Camera Name	DCS-7410	Time & Date	Tue Jan 1 00:42:24 2008	Firmware Version	1.00, 2824	MAC Address	00:03:1B:58:A4:01	IP Address	192.168.0.20	IP Subnet Mask	255.255.255.0	Default Gateway	192.168.0.1	Primary DNS		Secondary DNS		PPPoE	Failure	DDNS	Disable	<p><b>Helpful Hints..</b></p> <p>This page displays all the information about the camera and network settings.</p>
Camera Name	DCS-7410																										
Time & Date	Tue Jan 1 00:42:24 2008																										
Firmware Version	1.00, 2824																										
MAC Address	00:03:1B:58:A4:01																										
IP Address	192.168.0.20																										
IP Subnet Mask	255.255.255.0																										
Default Gateway	192.168.0.1																										
Primary DNS																											
Secondary DNS																											
PPPoE	Failure																										
DDNS	Disable																										
Log																											
Logout																											
<b>SECURITY</b>																											

## STATUS > Logs

The log shows you a list of events that have happened recently. You can download the log by clicking **Download**, or you can empty the log by clicking **Clear**.

Product: DCS-7410
Firmware version: 1.00

D-Link

DCS-7410
LIVE VIDEO
SETUP
MAINTENANCE
STATUS
HELP

Device Info

Log

Logout

SYSTEM LOG

The system log records camera events that have occurred.

CURRENT LOG

```

2008-01-01 02:10:54 System is booted up.
2008-01-01 02:13:05 admin is start to watch streaming by HTTP
2008-01-01 02:13:17 admin is start to watch streaming by HTTP
2008-01-01 02:13:43 admin is start to watch streaming by HTTP
2008-01-01 02:13:54 admin is start to watch streaming by HTTP
2008-01-01 02:13:57 admin is start to watch streaming by HTTP
2008-01-01 02:14:00 admin is start to watch streaming by HTTP
2008-01-01 02:14:03 admin is start to watch streaming by HTTP
2008-01-01 02:14:16 admin is start to watch streaming by HTTP
2008-01-01 02:14:24 admin is start to watch streaming by HTTP
2008-01-01 02:15:24 admin is start to watch streaming by HTTP
2008-01-01 02:17:57 admin is start to watch streaming by HTTP
2008-01-01 02:18:17 admin is start to watch streaming by HTTP
2008-01-01 02:29:27 System is booted up.
2008-01-01 00:00:28 System is booted up.
2008-01-01 00:05:17 admin is start to watch streaming by HTTP
2008-01-01 00:20:30 admin is start to watch streaming by HTTP
2008-01-01 00:21:19 admin is start to watch streaming by HTTP
2008-01-01 00:27:11 admin is start to watch streaming by HTTP
2008-01-01 00:28:26 admin is start to watch streaming by HTTP

```

Helpful Hints..

You can save the log to your local hard drive by clicking the Download button, and you can clear the log by clicking on the Clear button.

SECURITY



# Help

The **Help** screen provides you with support information about the DCS-7410 for your reference.

Product: DCS-7410 Firmware version: 1.00

**D-Link**

DCS-7410 // LIVE VIDEO SETUP MAINTENANCE STATUS HELP

Help Menu  
Logout

**HELP MENU**

- [LIVE VIDEO](#)
- [SETUP](#)
- [MAINTENANCE](#)
- [STATUS](#)

**LIVE VIDEO**

- [Camera](#)

**SETUP**

- [Setup Wizard](#)
- [Network Setup](#)
- [Dynamic DNS](#)
- [Image Setup](#)
- [Audio And Video](#)
- [Motion Detection](#)
- [Time and Date](#)
- [Recording](#)
- [Snapshot](#)
- [Digital Output](#)
- [RS-485](#)

**MAINTENANCE**

- [Admin](#)
- [System](#)
- [Firmware Upgrade](#)

**STATUS**

- [Device Info](#)
- [Log](#)

**SECURITY**

# D-ViewCam Installation

D-ViewCam software is included to manage up to 32 cameras simultaneously, send automated e-mail alerts, and record video to your hard drive when motion is detected or according to a set schedule.

Insert the D-ViewCam software CD into the CD-ROM drive. The D-ViewCam Installation screen will appear.

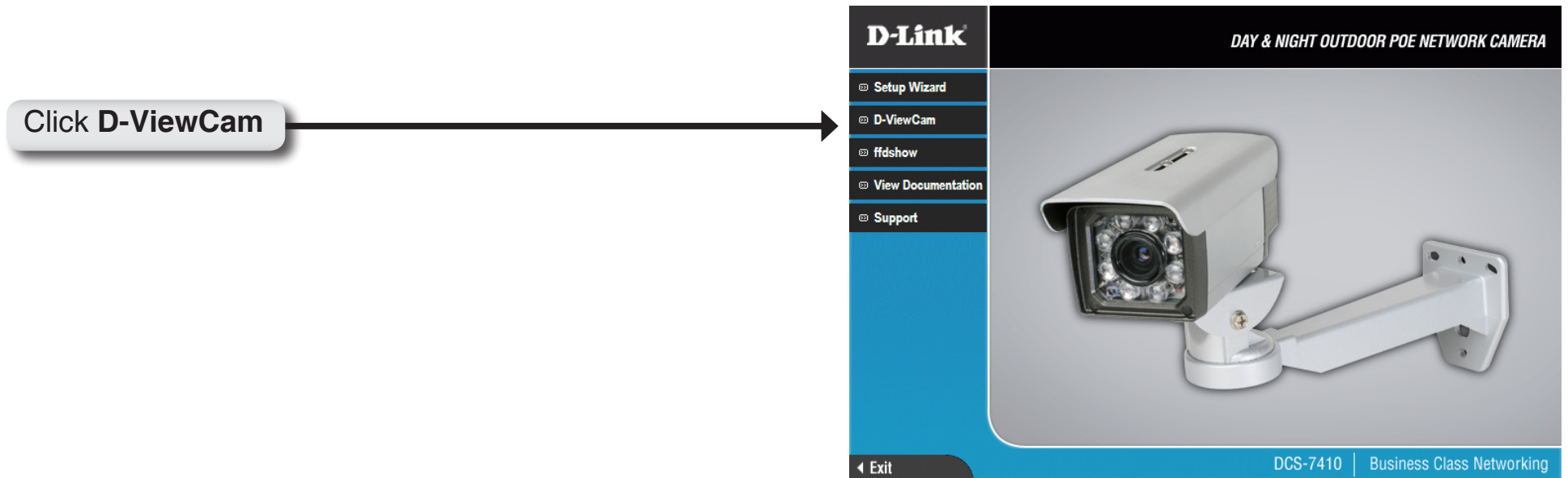

Select a language and click **OK** to continue.



Click **Next** to continue.

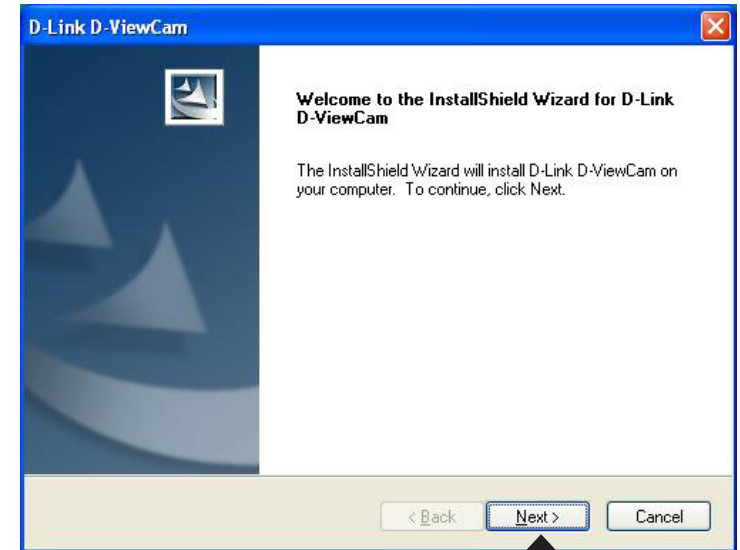

Click **Next**

Click **Browse** to choose a specific folder for the installation, otherwise click **Next** to continue.

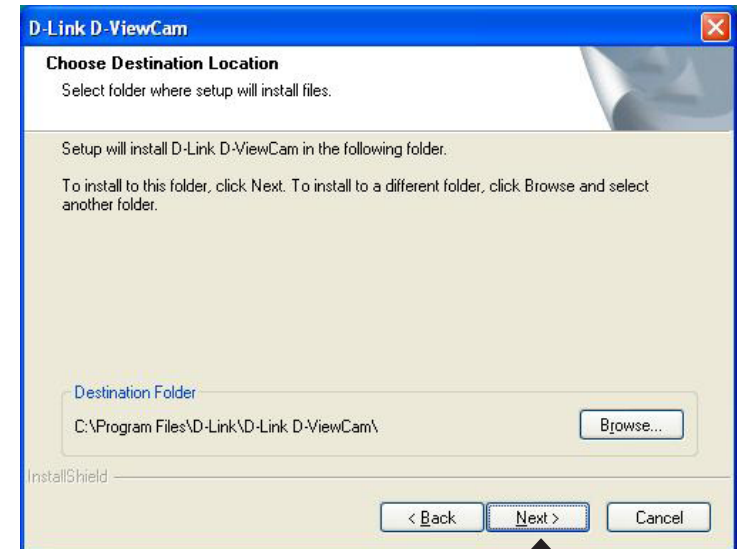

Click **Next**

Click **Next** to start the installation.

**Note:** The D-ViewCam installation process may take several minutes to complete.

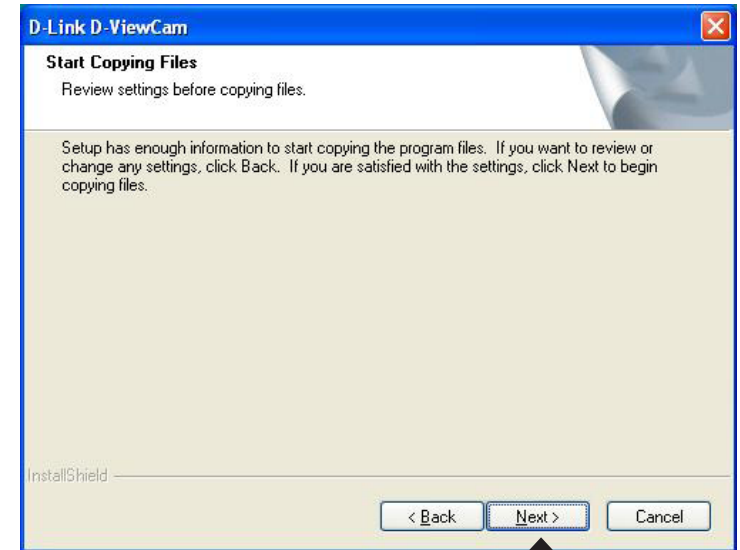

Click **Next**



Click **Finish** to complete the installation.

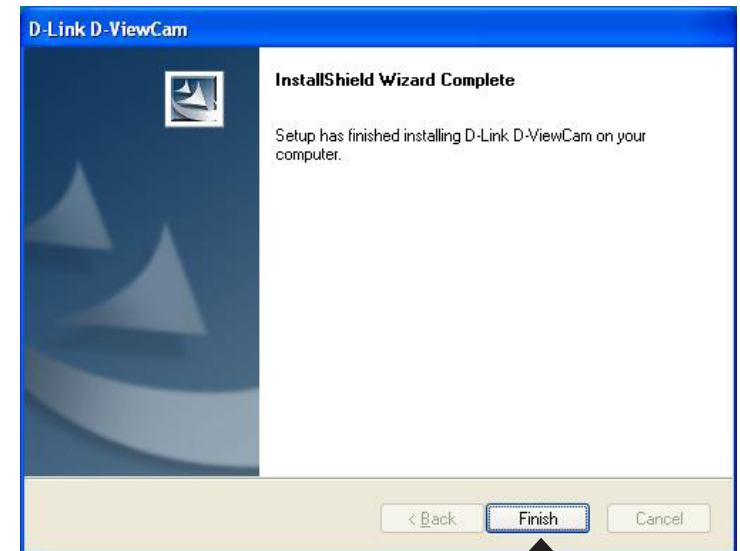

Click **Finish**



# Adding a Camera

This section will show you how to add a camera to the D-ViewCam system.

To start D-ViewCam, select **Start > All Programs > D-Link > D-Link D-ViewCam**.



Enter **Admin** as the default user name and leave the password blank. Click  to log into the system.

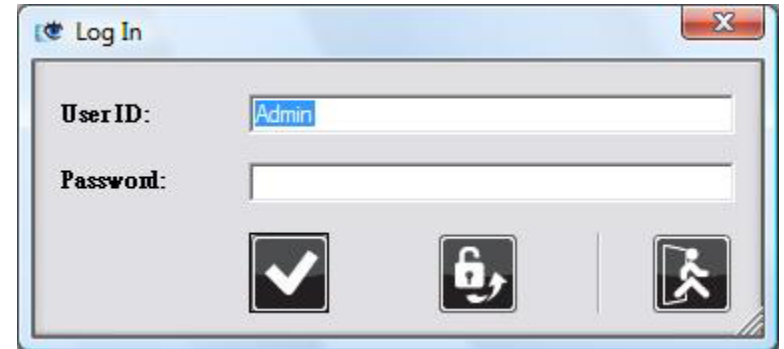

The **Add Camera Wizard** screen will appear. Use this wizard to add your cameras to the D-ViewCam system.

**Note:** Use the left or right arrow icons for navigation within the wizard.

Click  / **Next** to continue.

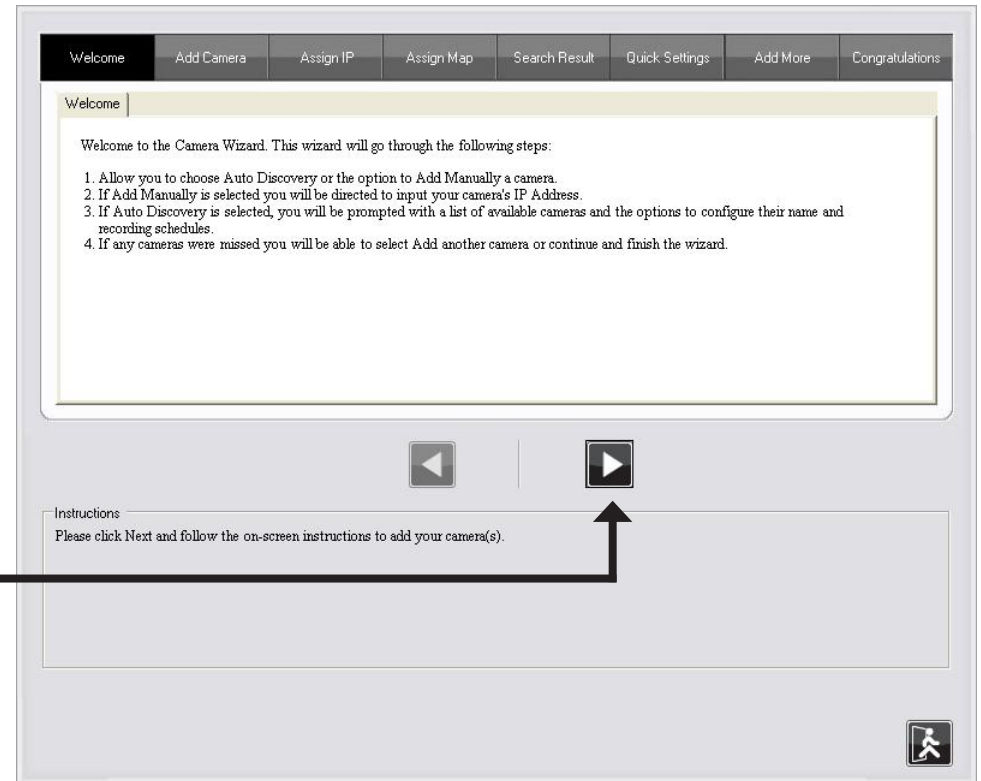

Click **Next**

Choose the method to add your camera(s). You can select **Auto Discovery** to automatically search for your camera(s), or **Add Manually** to add your camera(s) via the camera's IP address.

Click **Next** to continue.

If you selected **Auto Discovery**, the system will search all available cameras that are located on the same LAN with same subnet. The system will place all the cameras under the default map called **My Map**.

Click **Next** to continue.

If you selected **Add Manually**, enter the IP address or domain name, http port, model name, camera ID and password.

Click the “?” button to auto-detect the camera's model name. The model name will appear in the **Model Name** box.

Click **Next** to continue.

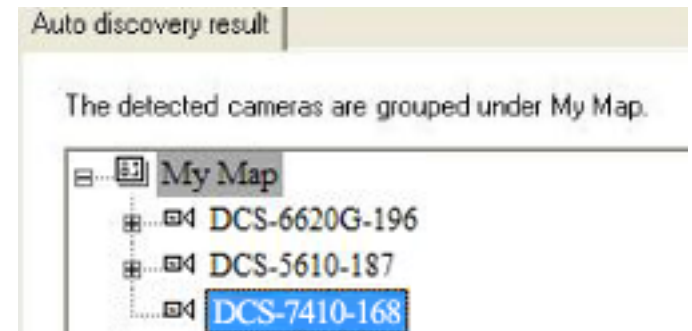
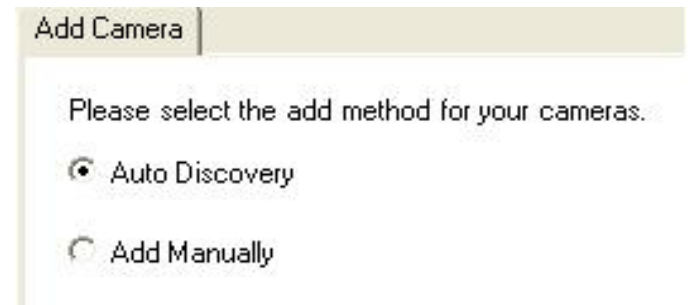

D-ViewCam shows the detected IP camera(s) information. You can choose and schedule recordings for each camera.

- **24/7 Continuous Recording:** Continuous recording - 24 hours a day, 7 days a week.
- **24/7 Motion Detection Recording:** Continuous monitoring, but records ONLY when motion is detected.
- **Office Hours Only:** Continuously monitors during office hours (08:00 AM to 06.00 PM) and records ONLY when motion is detected.
- **Non-Office Hours Only:** Continuously monitors during non-office hours (06:00 PM to 08.00 AM) and records ONLY when motion is detected.

Quick Settings

The discovered cameras information showed as below:

Camera Name	Model	Schedule Recording Type	Status	IP Address	MAC Address
DCS-5610-187	DCS-5610	None	Active	10.129.1.187	000D887D6DC4
DCS-6620G-99	DCS-6620G	None	Active	10.129.1.99	001346DC3BC3
DCS-7410-168	DCS-7410	None	Active	10.129.1.168	001346DC3BEB

Click **Next** to continue.



Select **Yes** to add other camera(s), or select **No** if you have no additional camera(s) to be added.

Click **Next** to continue.

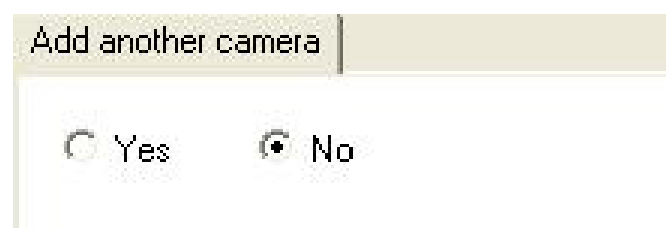

The **Add Camera wizard** is now complete. Click **Close** to access the D-ViewCam's main screen.

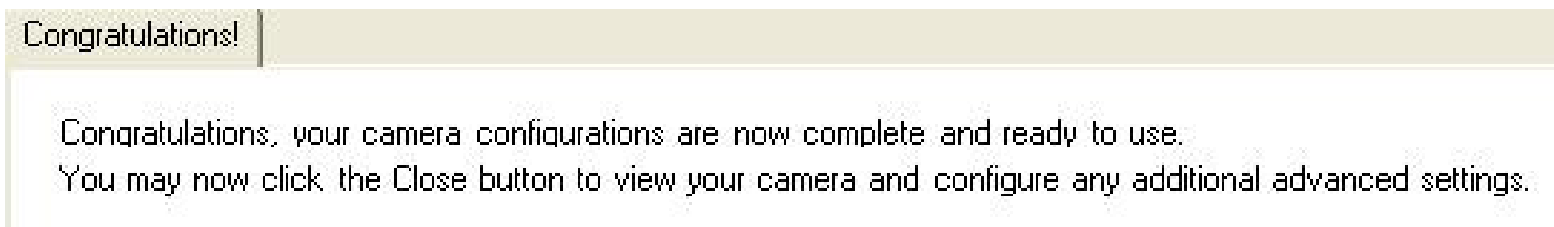

## Your D-ViewCam Installation is Complete!

**Note:** Please refer to the D-ViewCam user manual for information about using the D-ViewCam.

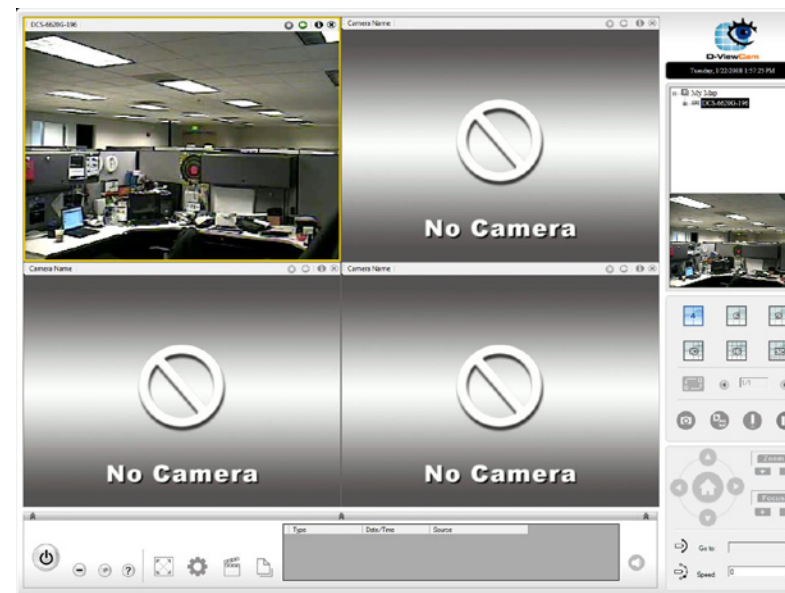

# Troubleshooting

## **1. What is a Network Camera?**

An Network Camera is a standalone system that connects directly to an Ethernet or Fast Ethernet network and supported by the wireless transmission based on the IEEE 802.11g standard, whereas conventional PC Cameras require connection to a powered PC to function. An Network Camera is an all-in-one system with a built-in CPU, providing a low cost web-based solution that can transmit high quality video images for monitoring. The Network Camera can be managed remotely, and can be accessed and controlled from any PC locally or through the Internet via a Web browser.

## **2. What is the maximum number of users that can be allowed to access DCS-7410 simultaneously?**

The maximum number of users that can log onto the Network Camera at the same time is 10. Please keep in mind that the overall performance of the transmission speed will slow down when a large number of users are logged on.

## **3. What algorithm is used to compress the digital image?**

MPEG-4 and MJPEG are used to provide high quality images at low bandwidths.

## **4. Can I capture still images from the Network Camera?**

Yes. You may record snapshots using the snapshot feature on the Home page. When viewing this page, press the “snapshot” button to capture the image and save it to your hard drive.

## **5. What network cabling is required for the Network Camera?**

The Network Camera uses Category 5 UTP cable for 10Base-T and 100Base-TX networking.

## **6. Can the Network Camera be used as a webcam for my computer?**

No, the DCS-7410 Network Camera only functions through a Fast Ethernet network.

## **7. Can the DCS-7410 be connected to the network if it consists of only private IP addresses?**

Yes, the Network Camera can be connected to a LAN with private IP addresses.

### **8. Can the DCS-7410 be installed and work if a firewall exists on the network?**

If a firewall exists on the network, port 80 needs to be opened for ordinary data communication, streaming audio, streaming video. The DCS-7410 uses port 5002 for streaming audio and port 5003 for streaming video. These ports or the ports you specify from the Advanced Tab in the Configuration screen, needs to be opened.

### **9. Why am I unable to access the DCS-7410 from a Web browser?**

Ensure that the ports configured for the DCS-7410 on the router or firewall are correct. In order to do that, you need to determine if the DCS-7410 is behind a router or firewall and then properly configure the ports of your DCS-7410. Other possible problems might be due to the network cable. Try replacing your network cable. Test the network interface of the product by connecting a local computer to the unit, with an Ethernet crossover cable. If the problem is not solved the Network Camera might be faulty.

### **10. Why does the Network Camera work locally but not externally?**

This might be caused by the firewall protection on your network. You may have to change the firewall settings in order for the Network Camera to be accessible outside your local LAN. Check with the Network Administrator and ensure that the Network Camera isn't conflicting with any Web server you may have running on your network. The default router setting might be a possible reason. Check that the configuration of the router settings allow the Network Camera to be accessed outside your local LAN.

### **11. I connected the Network Camera directly to a computer with a Ethernet cable and received a Windows error upon running the Installation Wizard.**

This Windows error will occur if the Network Camera is connected to a computer that is not properly configured with a valid IP address. Turn off DHCP from the Network Settings in Windows and configure the computer with a valid IP address, or connect the camera to a router with DHCP enabled. This error can also occur if the Installation Wizard icon is clicked more than once starting from the setup wizard.

### **12. The images appear to be of poor quality, how can I improve the image quality?**

Make sure that your computers display properties are set to at least 6-bit color. Using 16 or 256 colors on your computer will produce dithering artifacts in the image, making the image look as if it is of poor quality. In the Image Setup section of the web interface, you can adjust image related parameters including brightness, contrast, and saturation. Please refer to the **Setup > Image Setup** section for detailed information.

# DI/DO

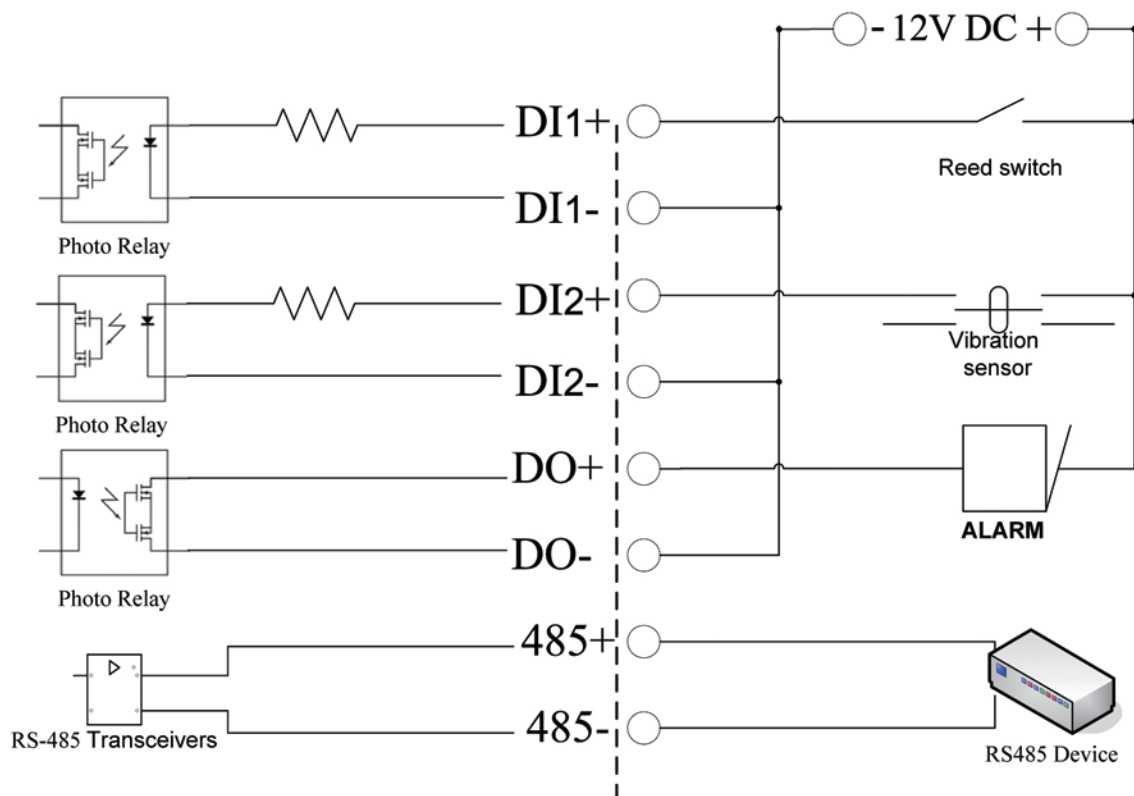

<b>DI</b>	Receives signals from a motion detector or any other external security device.
<b>DO</b>	Connects to an alarm or buzzer.
<b>485+/485-</b>	Connects to an RS-485 interface for controlling auxiliary equipment such as an external camera enclosure to perform PAN and TILT movement.

# Networking Basics

## Check your IP address

After you install your new D-Link adapter, by default, the TCP/IP settings should be set to obtain an IP address from a DHCP server (i.e. router) automatically. To verify your IP address, please follow the steps below.

Click on **Start > Run**. In the run box type **cmd** and click **OK**.

At the prompt, type **ipconfig** and press **Enter**.

This will display the IP address, subnet mask, and the default gateway of your adapter.

If the address is 0.0.0.0, check your adapter installation, security settings, and the settings on your router. Some firewall software programs may block a DHCP request on newly installed adapters.

If you are connecting to a wireless network at a hotspot (e.g. hotel, coffee shop, airport), please contact an employee or administrator to verify their wireless network settings.

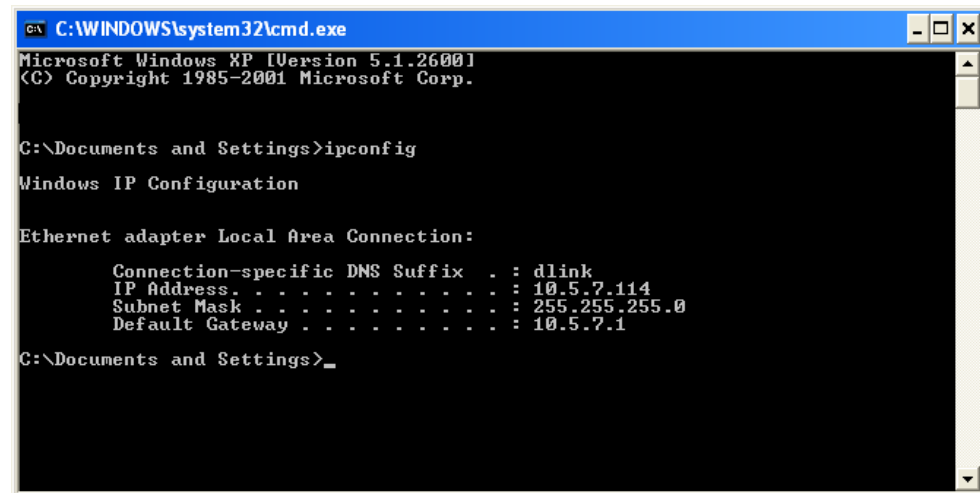

```
C:\WINDOWS\system32\cmd.exe
Microsoft Windows XP [Version 5.1.2600]
(C) Copyright 1985-2001 Microsoft Corp.

C:\Documents and Settings>ipconfig

Windows IP Configuration

Ethernet adapter Local Area Connection:

    Connection-specific DNS Suffix  . : dlink
    IP Address. . . . .                : 10.5.7.114
    Subnet Mask . . . . .              : 255.255.255.0
    Default Gateway . . . . .          : 10.5.7.1

C:\Documents and Settings>_
```

## Assigning a Static IP Address

If you are not using a DHCP capable gateway/router, or you need to assign a static IP address, please follow the steps below:

### Step 1

Windows® XP - Click on **Start > Control Panel > Network Connections**.

Windows® Vista - From the desktop, right-click **My Network Places > Properties**.

### Step 2

Right-click on the **Local Area Connection** which represents your D-Link network adapter and select **Properties**.

### Step 3

Highlight **Internet Protocol (TCP/IP)** and click **Properties**.

### Step 4

Click **Use the following IP address** and enter an IP address that is on the same subnet as your network or the LAN IP address on your router.

Example: If the camera's LAN IP address is 192.168.0.1, make your IP address 192.168.0.X where X is a number between 2 and 99. Make sure that the number you choose is not in use on the network. Set Default Gateway the same as the LAN IP address of your router (192.168.0.1).

Set Primary DNS the same as the LAN IP address of your router (192.168.0.1). The Secondary DNS is not needed or you may enter a DNS server from your ISP.

### Step 5

Click **OK** twice to save your settings.

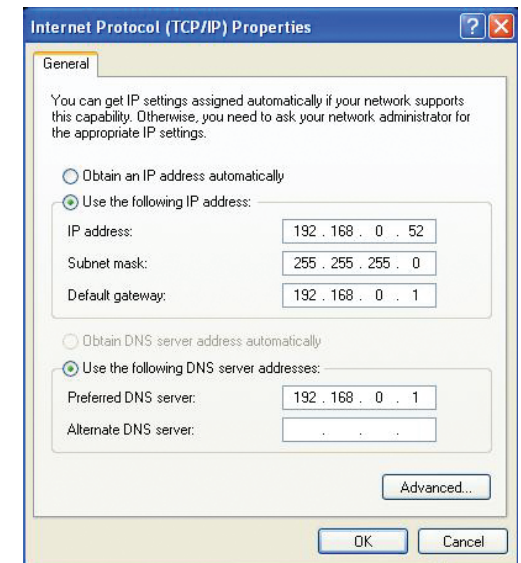

# Technical Specifications

## Video Codec

- MPEG4 / MJPEG

## Audio Codec

- GSM-AMR: 12.2Kbps, PCM: 8Kbps
- Full-duplex audio communication

## PoE

- Supports IEEE 802.3af standard

## Sensor

- 1/3" Sony CCD sensor, interlace scan mode

## SDRAM

- 64 Mbytes

## Flash Memory

- 8 Mbytes

## Lens

- 12mm board len, F1.4

## LAN

- 10/100Base - TX Ethernet ports x1
- IEEE 802.3 compliance
- IEEE 802.3u compliance
- Supports full-duplex operation
- MDI/MDIX auto-negotiation
- 802.3x Flow Control for full-duplex mode
- Supported IEEE 802.3af standard (PoE)

## Audio In

- Yes

## RS 485

- 2-pin (485A,485B) (Supports control of an external Pan-Tilt device)

## Audio Out

- Yes

## Reset Button

- Reset to factory default

## Dimension (WxDxH)

- 240(L) x 8.79(W) x 109.1(H)mm

## Weight

- 1.72kg

## Max Power Consumption

- 11.72W
- Input: 100-240VAC, 50/60Hz
- Output: 12VDC, 1.25A

## Networking

### Protocol

- IPV4, ARP, TCP, UDP, ICMP
- DHCP Client
- NTP Client
- DNS Client
- DDNS Client
- SMTP Client
- FTP Client
- HTTP Server
- Samba Client
- PPPoE
- RTP

- RTSP
- RTCP
- 3GPP

#### **Ethernet**

- 10/100M BaseT Fast Ethernet auto negotiation

#### **Video**

##### **Algorithm Supported**

- Simultaneous MPEG4/MJPEG dual format compression
- JPEG for still images

##### **Features**

- Adjustable image size and quality
- Time stamp and text overlay

##### **Video Resolution**

- MPEG-4/MJPEG video resolution up to D1

##### **Low Lux**

- 0.1 lux @ F1.4

##### **3A control**

- AGC (Auto Gain Control)
- AWB (Auto White Balance)
- AES (Auto Exposure Setting)

##### **Electronic shutter**

- NTSC: 1/60 ~ 1/100000 sec.
- PAL: 1/50 ~ 1/110000 sec.

#### **Operating System**

- Microsoft Windows XP or Vista

#### **Physical Environment**

##### **Power**

- 12V 1.25A switching power adapter
- External AC-to-DC Switching Power Adapter or PoE Ethernet port

##### **Operation Temperature**

- 0 to 40°C (32 to 104°F)

##### **Storage Temperature**

- - 20 to 70°C (-4 to 158°F)

##### **Humidity**

- 20-80% RH non-condensing

#### **Emission (EMI), Safety & Other Certifications**

- FCC Class A
- IC
- CE
- C-Tick