

D-Link Video Server

DVS-104 User Manual



ver. 1.00
20040507

Before You Use

It is important to carefully examine the contents with the Chapter [Package Contents](#) after opening the package. If there is anything missing, contact your reseller. Read the Chapter [Physical Description](#) before assembling and operating the device and peripherals. Understanding the physical description can prevent damage caused by abnormal usage and reduce most problems during installation.



Basically Video Server is a network device and should be easy to use for those who already have basic network knowledge. If there is a system error and it does not recover easily due to erroneous configuration, read the [System recovery](#) section in Appendix [Troubleshooting](#) to restore factory default settings and perform installation again.

Video Server has been designed for various environments and can be used to build various applications for general security or demonstration purposes. For standard applications, find the appropriate section in the Chapter [How to Use](#) for your application and follow the steps to setup the system. To make best use of Video Server, read Chapter [Advanced Functions](#) to get creative ideas and review Chapter [System Configuration](#) for detailed explanations of system configurations. To those professional developers, the Appendix [URL Commands of Video Server](#) will be a very helpful reference to develop a Web-based application.

Surveillance devices may be prohibited by law in your country. Though Video Server is not only a high performance surveillance system but also a networked video server, ensure that the operations of such devices are legal before installing this unit for surveillance.

Those paragraphs preceding with  must be fully understood and cautioned. Ignoring the warnings may result in serious hazards.

Table of Contents

Before You Use	1
Package Contents	4
Features and Benefits	5
Physical Description	7
Front Panel	7
Rear Panel	9
How to Install	12
Ethernet Environment	13
Modem Environment	19
How to Use	29
Authentication	29
Installing Plug-in	30
Main Page	31
System Configuration	34
Introduction	34
 Setup Wizard	35
 Application Wizard	35
Definitions of Configuration	36
Advanced Functions	49
Capture Up-to-date Still Images	49
Get Continuous Images	50
Video Embedded in Customers' Homepage	51
Download Event-triggered Snapshots	52
Uploading Snapshots Periodically	53
Customize Graphics in Homepage	54
Command Script for Complex Applications	56

URL for External Device Control 59
URL of System Maintenance 61
Configure System via FTP 62
Telnet Commands 70

Appendix 72

A. Troubleshooting 72
B. Frequently Asked Questions..... 75
C. Upgrade System Firmware 79
D. URL Commands of Video Server..... 80
E. Settings of Supported PTZ Cameras..... 95
F. Camera Control Cable..... 96
G. Time Zone Table 97
H. Technical specifications 100

Package Contents

If any of the following items are missing, please contact your reseller.

- Video Server DVS-104



- Camera control cable

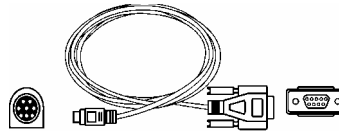

- Power adapter



- Null modem cable

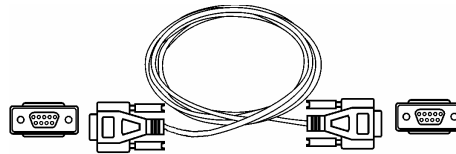

- Two I/O terminal connectors



- Utility CD-ROM



Features and Benefits

Video Server is a high-performance networking video multiplexer. With powerful VLIW DSP core and fully optimized algorithm, it can compress and transmit the high quality real-time video through standard TCP/IP inter-network. In addition to meet the basic needs of video feed, many advanced features are added to help building applications of surveillance or web attraction. The state-of-art design well compromises among stable, robust, simple-to-use and flexibility.

Real-time motion-JPEG compression

Four video inputs can be efficiently compressed into packets of JPEG images without delay. Optimal compression engine makes the equivalently excellent image with much smaller size. There is no more sacrifice in remote monitoring and storage. Five levels of compression ratio and three sizes of image resolutions are easy to meet your requirement.

Robust system operation

Industrial real-time operating system prevents from malicious hackers and virus that threat Windows or Linux systems. The on-board watchdog eternally monitors the system operations for dead-proof.

Easy Web access via standard browser

You don't have to install any software to access Video Server. The embedded Web server makes users can access Video Server anywhere over Internet with any popular Web browser. As long as you are connected to network, you can cast your eyes on your precious property.

Password protection of system access

Password level protection is provided by the system to prevent from malicious intruders from network. Once the password of administrator is entered, any user will need password authentication to access Video Server. Each user can have individual access right to view video or control external devices.

Built-in motion detection

No more external sensors are required. Each video channel can be setup to detect any motion with customized settings. By tuning the object size and sensitivity, it is more reliable to fit into your environment. With this built-in facility, you can easily setup a

Weekly schedule for automatic surveillance

The user-defined time period will repeat weekly to check any security settings and accordingly sending notification or drive external devices. It is easy to install in SOHO, retail shop and home as a security system.

Flexible I/O control for external devices

There are four opto-isolated sensor inputs and two relay outputs to control external devices. System integrators can easily replace the current analog systems to build an advanced security system.

Bundled powerful surveillance software

To extend the capabilities of Video Server, a powerful surveillance program is included in the package and totally free to use. Users can easily utilize the existing PC to be a digital video recorder. Schedule or one-click recording keep every important moment in your local hard disk; reliable motion detection and instant warning make you sharp for every conditions. Quick and simple search and playback let you easily find the moment you want to inspect more carefully and output to AVI files for another copy.

Remote system upgrade

To achieve the promise we made to support our valuable customers in life-time, the most up-to-date firmware is always put on our web site to add new functions or solve known bugs. A free upgrade wizard is included to facilitate the job.

Developer's technical support

The high-performance Video Server can be integrated into many applications under perfect control of budget. The complete programming interface and standard JPEG format can ease and speed developers' task. More creative ideas can be found on our Web site.

Physical Description

Front Panel

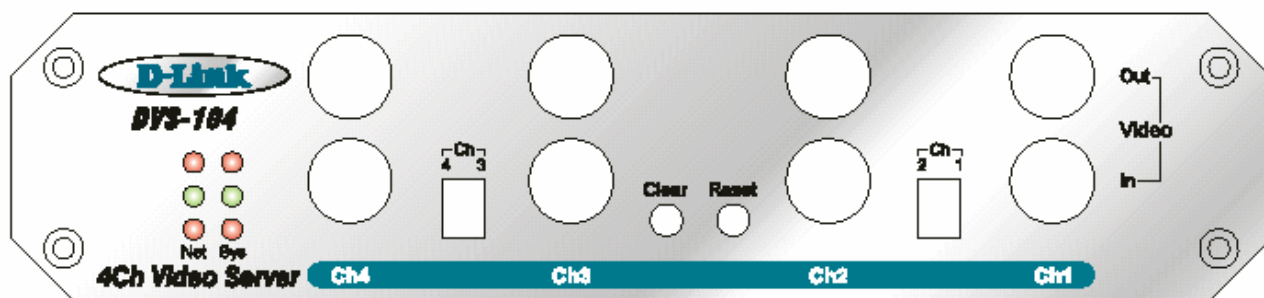

Status LED's

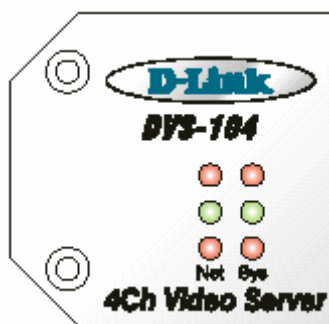

Each time Video Server starts up, it will perform power-on-self-test, abbreviated as POST, to examine every hardware module. As soon as the administrator plugs in the power connector both LED's under the power LED will flash one by one until the diagnosis is done. If the result is good, both status LED's will turn off for a while and then follows the pattern below. If any module fails, refer to the Appendix A for the error

pattern and follow the trouble-shooting procedures. If the system still cannot operate normally, please contact your reseller for technical service.

Network Interface	Condition	LED1 (Heartbeat)	LED2 (Status)
Ethernet	before IP installed	OFF	OFF
	after IP installed	Blink	OFF
	during camera control	Blink	Blink
PPP with modem	after POST	Blink	ON
	during camera control	Blink	Blink
PPP with null modem	before connected	ON	ON
	after connected	Blink	ON
	during camera control	Blink	Blink

BNC video inputs "IN" & outputs "OUT"

Video Server allows up to four cameras attached at the same time. To ensure video modulation type being detected correctly, cameras should be attached sequentially from "VIDEO1" to "VIDEO4" and powered on before Video Server is powered on. There are also four loop-through connectors of video outputs for conjunction with other capturing devices like time-lapsed VCR. In such case, read the next paragraph for correct settings.

DIP switches "1" to "4"

There are four DIP switches numbered from "1" to "4" in the front panel regarding of each video input. They are used to enable the 75-ohm resistance of video impedance. They should be kept ON if there is only one camera connected to each video input. If users want to connect another device such as VCR or multiplexer to the video output, the switch should be turned up to disable the impedance.

Auxiliary buttons "CLEAR" & "RESET"

There are two buttons located at the center of the front panel, one is labeled "CLEAR" and the other is labeled "RESET". Refer to the Appendix [Troubleshooting](#) for the detailed usage of system recovery.

Rear Panel

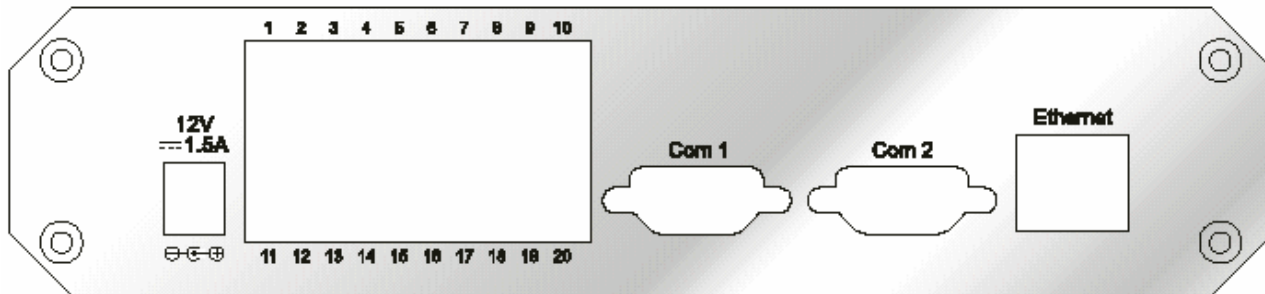

Ethernet 10/100 socket

Connect to an Ethernet network with a UTP category 5 cable of length shorter than 100 meters according to the standard. Once the Ethernet cable is connected without error, Video Server will utilize the Ethernet interface prior to the modem attached to COM2.

COM1 port

This RS232 serial port is dedicated to controlling the PTZ cameras attached to COM1 unless the administrator pre-configures COM1 as an RS485 interface that is accessed through two pins in the general I/O terminal block.

COM2 port

This RS232 serial port can connect with a modem or the included null modem cable to utilize dial-up network when Ethernet is not available. If Video Server operates with an Ethernet interface, the administrator may use this port to control another PTZ cameras attached to this serial port.

General I/O terminal block

Video Server provides a very flexible general I/O interface to combine with the user's security devices such as sensors, alarms, lighting or door locks. Two green connectors are included in the package to connect the external devices. The general I/O terminal block has twenty pins for device control. These pins can be divided into three categories based on their functions, including power source, RS485 and digital inputs and outputs.

No.	Pin description	Regulation
1	DC power output(-)	Max. 500mA at 12V DC
2	DC power output(+)	Max. 500mA at 12V DC
3	Relay output 2 – Normal Close	Max. 1A, 24V DC or 0.5A, 125V AC
4	Relay output 2 – Common	Short with NC at initial state
5	Relay output 2 – Normal Open	Max. 1A, 24V DC or 0.5A, 125V AC
6	Relay output 1 – Normal Close	Max. 1A, 24V DC or 0.5A, 125V AC
7	Relay output 1 – Common	Short with NC at initial state
8	Relay output 1 – Normal Open	Max. 1A, 24V DC or 0.5A, 125V AC
9	RS485 A	D+, non-inverting
10	RS485 B	D-, inverting
11	External power input	Min. 1.5A, 12~15V AC or DC
12	External power input	Min. 1.5A, 12~15V AC or DC
13	Opto-isolated sensor input 1(+)	Max. 50mA, 12V DC
14	Opto-isolated sensor input 1(-)	Ground
15	Opto-isolated sensor input 2(+)	Max. 50mA, 12V DC
16	Opto-isolated sensor input 2(-)	Ground
17	Opto-isolated sensor input 3(+)	Max. 50mA, 12V DC
18	Opto-isolated sensor input 3(-)	Ground
19	Opto-isolated sensor input 4(+)	Max. 50mA, 12V DC
20	Opto-isolated sensor input 4(-)	Ground

Power source

Pair of pin 11, 12 of AC or DC input is a replacement with the power adapter in case the range cannot meet the requirement. The voltage of the power source can be AC or DC and should fall in the range between 12V and 15V. Polarity does not matter. The DC output through Pin 1, 2 is fed from power adapter of Video Server or pin 11 and pin 12 if an external power source is attached. The current of external devices is limited to less than 500mA.



The power adapter of Video Server and the external power supply are prohibited to exist together. Only one source can feed power to Video Server. Improper usage will result in serious damage.

RS485 interface

If the device connected to COM1 has an RS485 interface, wire two control lines to pin 9 and pin 10. After switching to RS485 on the configuration page, the PTZ control

commands will be directed through pin 9 and pin 10. If the distance from the controlled device is too far to allow accurate function, an external power source may be used to amplify the RS485 signal.

Digital I/O control

Video Server provides four pairs of digital inputs and two sets of relay switches. Pin 13 to pin 20 can be connected to external sensors and the state of voltage will be monitored according to the programmed conditions on the configuration page or the external script file. Both relay switches can be used to turn on or off external devices. When the system starts up, COMMON of both relay switches will be short with NC. A simple diagram of example is shown below.

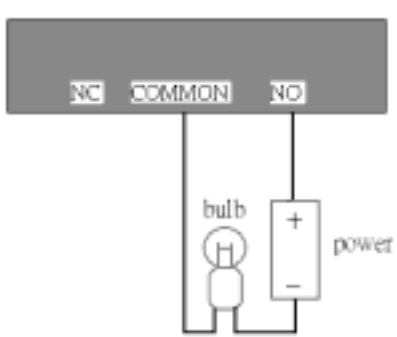

If DI1 in configuration is set as rising to drive DO1 to high that denotes COMMON of DO1 short with NO, then the bulb will light when DI1 signal changes from 0V to 12V.

Power adapter

Plug the power jack of the included power adapter to Video Server. Connecting the power adapter should be the last operation while physically installing Video Server. Administrators may feed an external power source through pin 11 and pin 12 of the general I/O terminal block to replace the power adapter.

 The power adapter of Video Server and the external power supply are prohibited to exist together. Only one source can feed power to Video Server. Improper usage will result in serious damage.

How to Install

To easily fit into various environments, Video Server automatically detects the attached interfaces and configures itself to the best condition. Therefore users need not care whether the connected cameras are either NTSC or PAL, how to select the network between Ethernet and modem, and whether the Ethernet speed is 10Mbps or 100 Mbps.

Video Server supports Ethernet and modem interfaces according to the user's existing network. Ethernet can provide higher bandwidth to achieve the best performance while dial-up network with modem is more common in current Internet applications. Refer to the related installation section for your network environment. If both interfaces are available, Ethernet is recommended and will be chosen as the first priority if Ethernet cable and modem are concurrently attached. Managing to install in the other interface will automatically clear the previous network settings to start new installation.

In the following content, "**user**" refers to those who can access Video Server and "**administrator**" means the supervisor who has the root password to configure Video Server in addition to general access. Administrators should carefully read this manual, especially during installation.

Ethernet Environment

Hardware installation

Before installing multiple Video Server's at the well-chosen locations, the administrator should memorize the serial numbers on the packages respectively for future use.

Cable connection

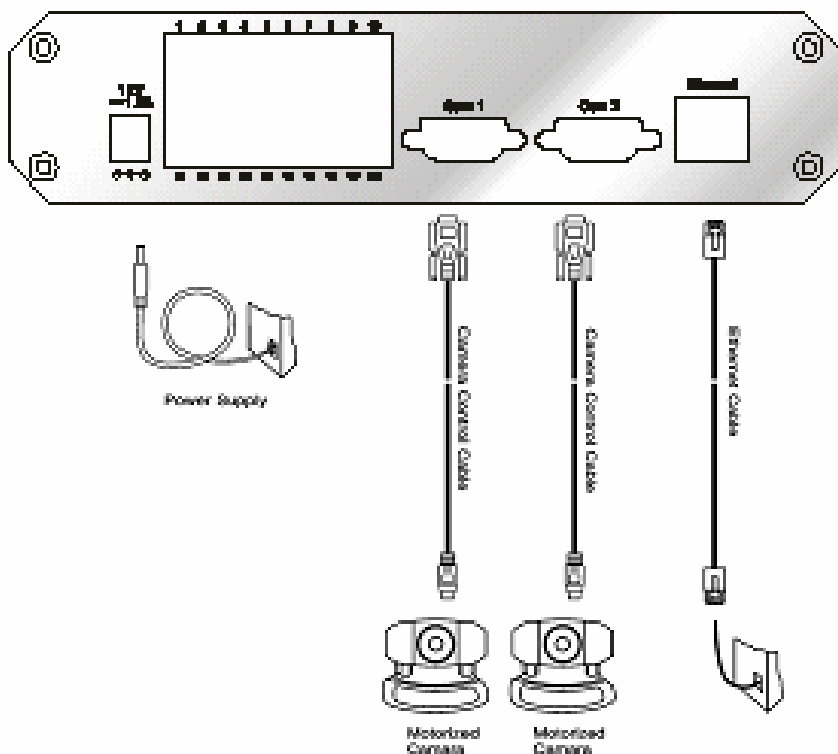
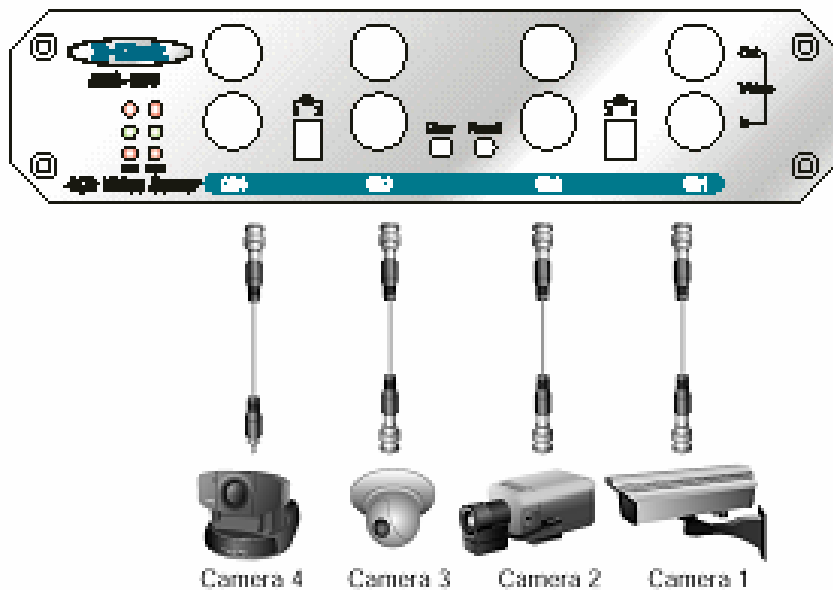

Shut down all the peripheral devices prior to connection. The video BNC, Ethernet cable and power adapter are essential for basic viewing function. If the attached cameras belong to the same motorized model, they can be concatenated to single COM port and will be differed by camera ID set on the cameras. Refer to the related configuration section for detailed description.

Power on

Make sure all cables are correctly and firmly connected. Before turning on Video Server, remember to run Installer program on PC or notebook in the same network first. As long as the "**Reset network at next boot**" option in network Web page is enabled, the Installer program is needed to install Video Server. Turn on cameras, sensors, alarm devices, and then attach power adaptor of Video Server to the electric power socket. After the POST (power-on self test) is complete and the result is successful, Video Server is ready for software configuration as described in this manual. At this stage, network speed and video modulation type are automatically detected.

Software installation

Easy way with installer program

In order to configure Video Server's remotely, administrators should keep the **MAC address** of the new Video Server's for identification and initial passwords. After successfully mounting Video Server's in the proper position, run the Installer program on the PC in the same network to locate the newly mounted Video Server's. Video Server's also support manual setup procedures to non-Windows based environments. The manual procedure is described next.

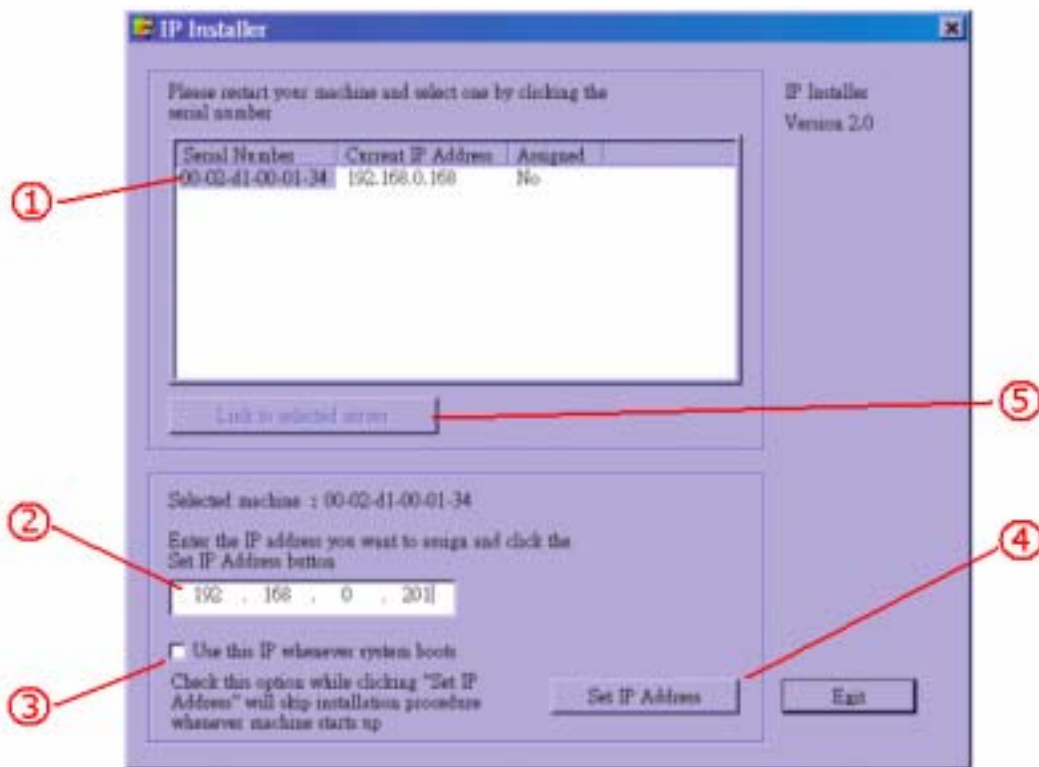

After the POST is done, Video Server will try to configure itself by detecting the network environment. If there is DHCP service over the network, the Installer program will catch the given information, then display the serial number and given IP address for each Video Server as the figure above. To install the IP address, follow the steps.

- 1 Click on the entry with the serial number you want to install. If the "**Assigned**" field of the entry is labeled "**Yes**", that means the Video Server has already been installed.
- 2 Type the desired IP address if it is other than the IP address given by the DHCP server.
- 3 Check the box to fix the IP address of the Video Server. Otherwise the Video Server will lose the network address at next system boot and you have to run this installer again.
- 4 Click **Set IP Address** to progress the installation.
- 5 After successful notification, administrators may keep the address information and

click directly on [Link to selected server](#) to access the Video Server in the default browser. If the IP address is taken by another network device in the network, the Installer program will pop out another message window to warn that the assigned IP conflicts. In this case, administrators should ask the network supervisor for a vacant IP address.

While **“Use this IP whenever system boots”**, is checked, a dialog window may pop out to ask for **“Server FTP Port”** and **“Root Password”** because they are already changed by administrators to other than default settings. If the original settings are lost, restore default settings and run software installation again.

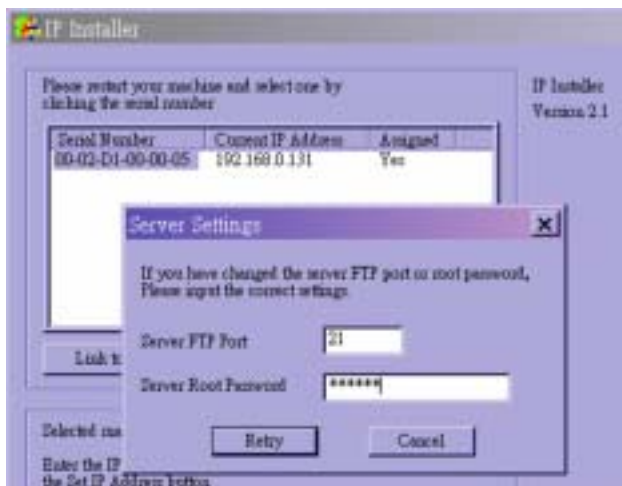

Once the installation is complete, administrators should follow the [First access to Video Server](#) section for necessary checks and configurations.

Manual way with existing programs

For those environments such as MAC, Linux, Unix or other operating systems, whose installer is not yet available, some common network tools including ARP and PING can be used to install Video Server. Before proceeding further, make sure ARP and PING programs exist.

First, type `arp -s "assigned IP address" "Ethernet address"` to add an entity in the system's name table. The Ethernet address is identical to the serial number of Video Server and should be typed in the appropriate format like "uu-vv-ww-xx-yy-zz" or "uu:vv:ww:xx:yy:zz", which depends on the operating system.

Once the name entity is added, type `ping "assigned IP address"` to invite the new Video Server. If it replies, that means Video Server has accepted the assigned IP address and is ready for access. The first several ping requests may fail during the self-configuration period of Video Server. Since the accurate grammar of ARP and PING depends on the operating system, refer to its related help manual.

Example of DOS prompt in Windows 2000

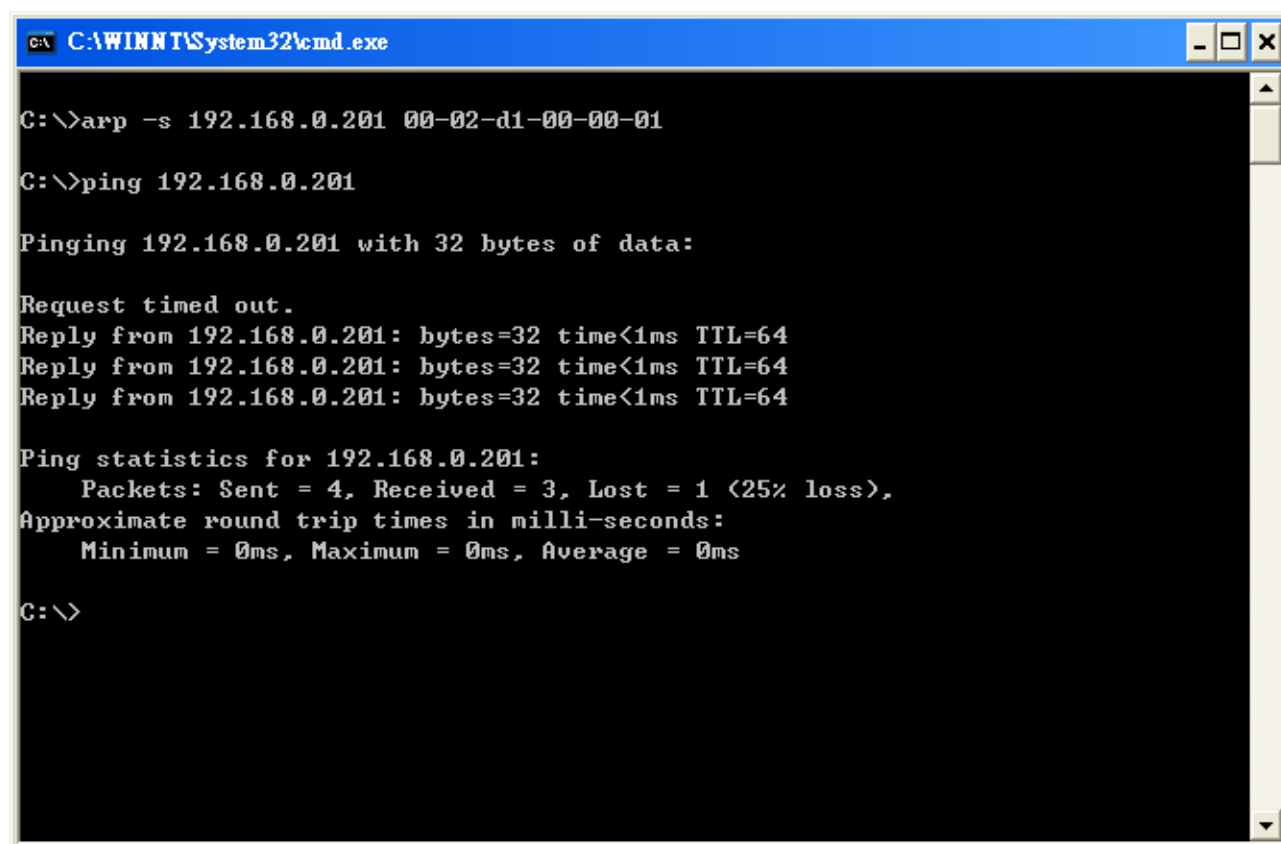

```
C:\WINNT\System32\cmd.exe

C:\>arp -s 192.168.0.201 00-02-d1-00-00-01

C:\>ping 192.168.0.201

Pinging 192.168.0.201 with 32 bytes of data:

Request timed out.
Reply from 192.168.0.201: bytes=32 time<1ms TTL=64
Reply from 192.168.0.201: bytes=32 time<1ms TTL=64
Reply from 192.168.0.201: bytes=32 time<1ms TTL=64

Ping statistics for 192.168.0.201:
    Packets: Sent = 4, Received = 3, Lost = 1 (25% loss),
    Approximate round trip times in milli-seconds:
        Minimum = 0ms, Maximum = 0ms, Average = 0ms

C:\>
```

First access to Video Server

Change initial password of administrator

Starting the Web browser to connect to the assigned IP address of Video Server, users will be asked for user name and password by an authentication message window. A root password, identical to the Video Server's **MAC address**, is needed for the initial access to a newly installed Video Server. The administrator must change the root password immediately after the initial installation to ensure security. The new root password should be well memorized since there is no way to retrieve or recover it. After changing the password, the browser will display an authentication window again to ask for the new password.

Manage user privilege

For complete protection from illegal usage, Video Server provides three privileges and always needs user name and password before access. The lowest level is DEMO mode whose services are subject to administrator's permission. The standard level is the USER mode that consists of twenty user profiles. Each user is able to access Video Server under the given privilege, except for system configuration. The twenty user profiles are also maintained by the administrator. The highest level is ROOT mode that only opens to administrators for initial setup, system configuration, user administration and software upgrade. The user name of the administrator is internally assigned to "**root**".

Complete the network settings

Although Video Server already can be accessed after software installation in local area network, administrators should complete the network settings in the configuration page. The complete network configurations including subnet mask as well as the IP address of default gateway and DNS are provided by your network administrator or Internet service provider. Once the wrong network settings make Video Server fail to work, refer to Appendix A to restore factory default settings.

By default Video Server will need administrator's installation every time it reboots. If the network settings are sure to work all the time, disable the install option in network configuration Web page or Installer program.

Details about configurations are described in the relative category of the Chapter [Definitions of Configuration](#).

Modem Environment

Hardware installation

Though Video Server is designed to serve real-time images in Ethernet, it also supports the dial-up network. To use a dial-up network, the Ethernet socket should be left disconnected since Ethernet is the first priority among available interfaces. After powering up, Video Server will detect if any external modem is connected to COM2. As soon as a modem is detected, the heartbeat LED will flash periodically. If no modem responds, Video Server will assume the included null modem cable is connected to perform system configuration. Then both LED's under the power LED will turn on until the dial-up connection over null modem is established.

Installations of both null modem and modem are introduced as follows. The null modem mode can be used for point-to-point connection in local environment; the modem mode also applies to TA in ISDN network. Though the baud rate can be setup to 115200 bit per second, the actual data rate depends on the network connection.

In the following content, dial-in connection denotes a passive Video Server waiting for a phone call to establish a point-to-point connection. Dial-out connection denotes an active Video Server to dial out to the other end of a dial-up server or any Internet service provider, abbreviated as ISP, to request a point-to-point connection.

Cable connection

Null modem mode

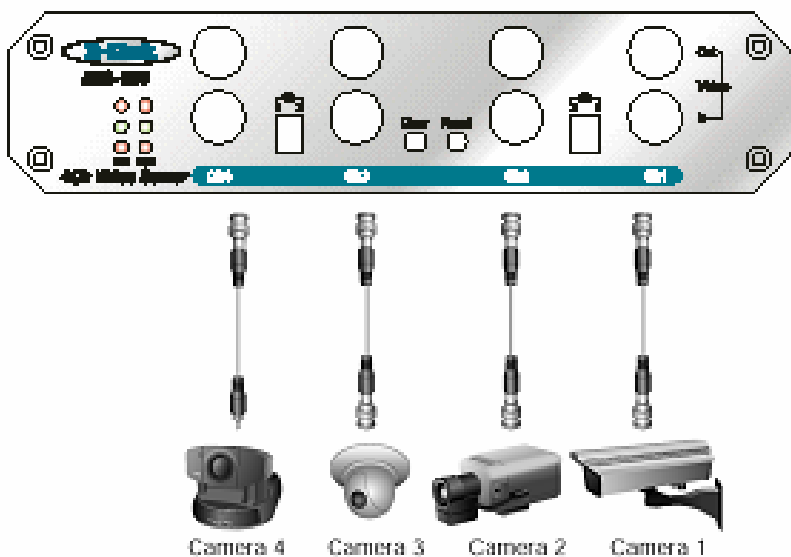

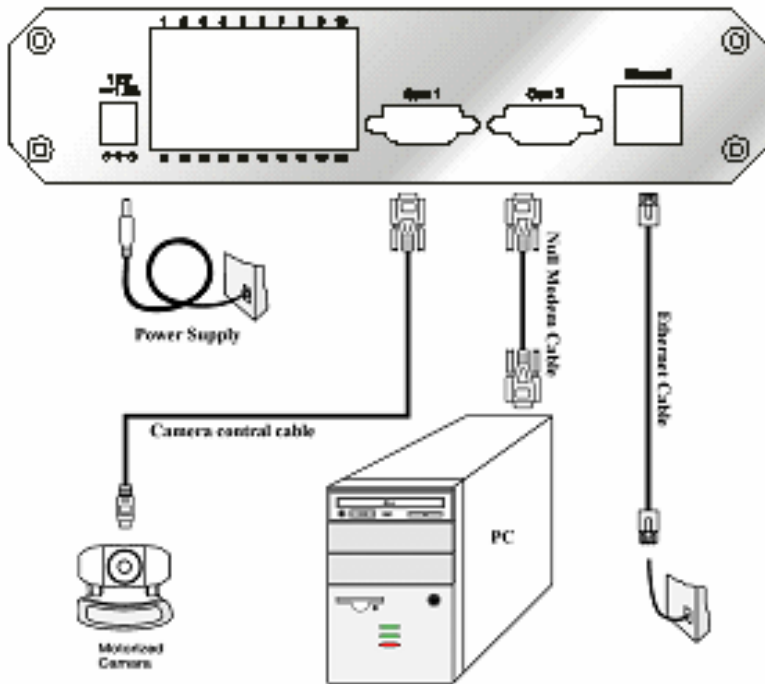

Shut down the peripheral devices prior to connection and keep the power adaptor unplugged until other cables are firmly connected. In the environment without Ethernet, administrators can use the included null modem cable to connect to Video Server directly and access point-to-point. After necessary information is entered and saved, turn off Video Server and remove the null modem cable. Follow the installation of modem mode in next paragraph to connect to Internet. Note Video Server will not really reset system where it is used to in null modem mode.

Modem mode

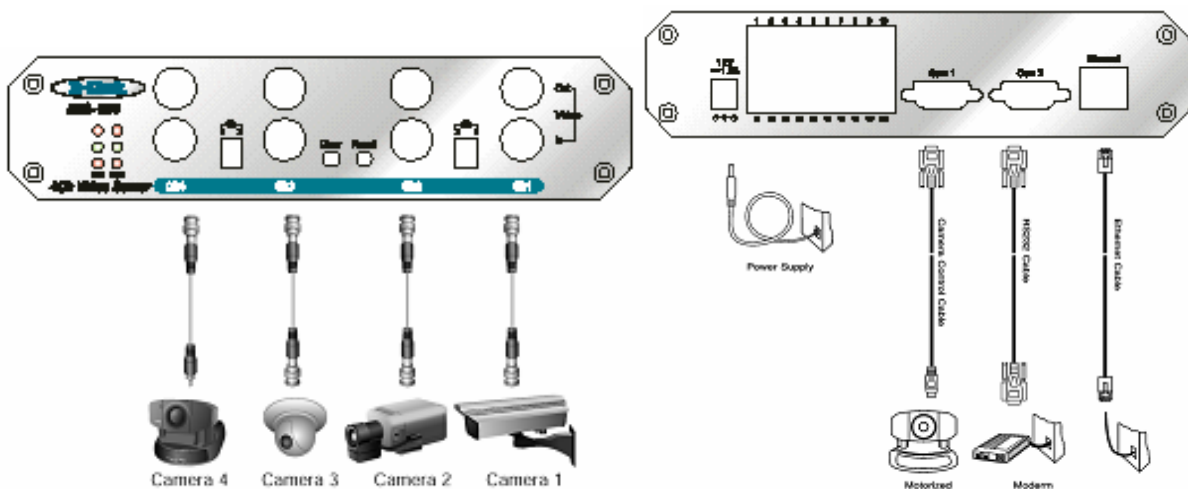



If users have setup a remote dialup server or subscribed to an ISP service, Video Server can be configured to dial to the server upon user-defined events. Otherwise it will wait permanently for the user's call to establish a network connection to provide services. Before installation, make sure the necessary dialing information is correctly setup via Ethernet or null modem connection.

Power on

Make sure all cables are correctly and firmly connected. Turn on cameras, sensors, alarm devices, and then finally attach the power adaptor of Video Server to the electric power outlet. Since most automatic detections of hardware perform when the system starts, Video Server should be turned on after all peripherals are turned on and ready.

D-Link® Building Networks for People

Software installation

Via Ethernet

Enter the COM2 configuration Web page and select the driver type as modem. Well configure each field for dialing information. Refer to the COM2 section in Definition of Configuration for detailed description.

Via null modem

Install a new modem

1. Open the control panel and double click the modems icon.



2. Check "**Don't detect my modem.....**" item and click on **Next >** to install a new modem.



3. From (Standard Modem Type) choose the **Standard 33600 bps Modem** and click on

Next >

4. Choose the serial port that the included null modem cable is attached to and click on **Next >**. The null modem is now ready for use.



If no Dial-Up adapter exists in the system, Windows may automatically prompt to install. Press **OK** to continue. If it does not start automatically, double click the network icon in control panel to install Microsoft dial-up adapter.

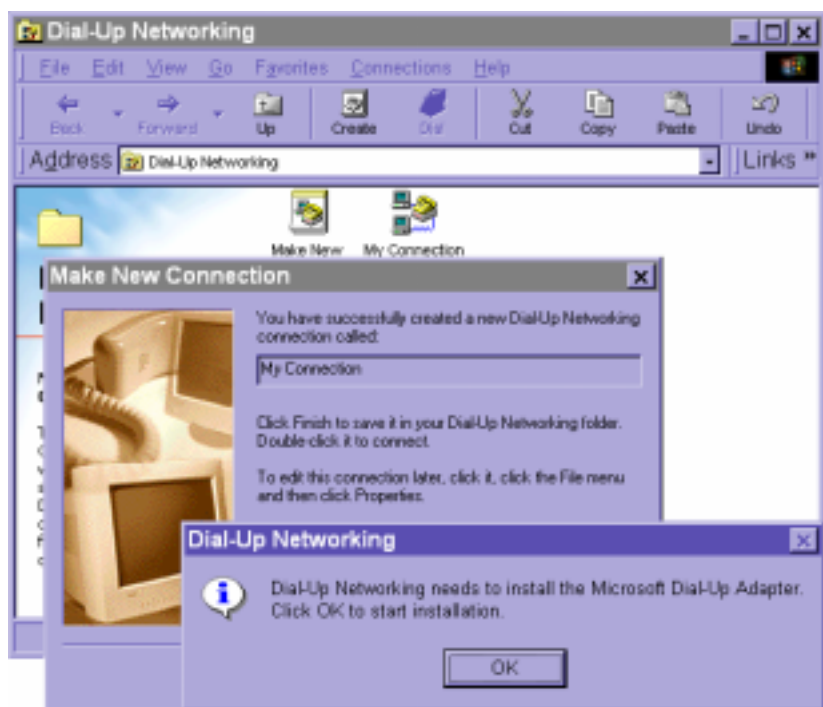

Setup a new connection

1. After the 33600 bps modem is installed, open the dialup network folder in Windows to build a new connection.

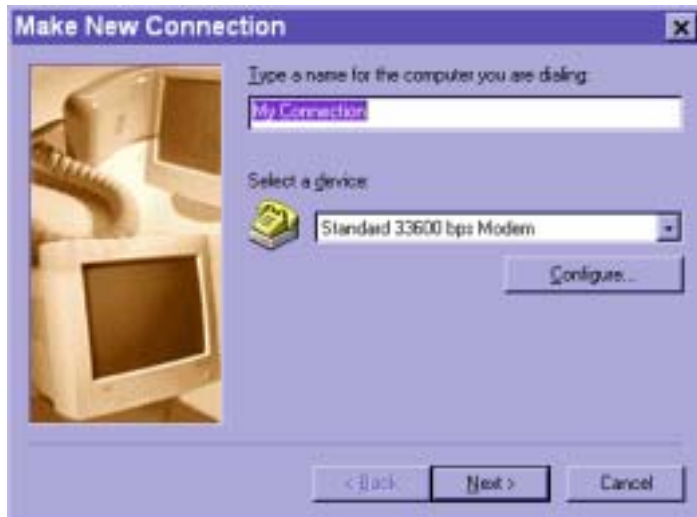
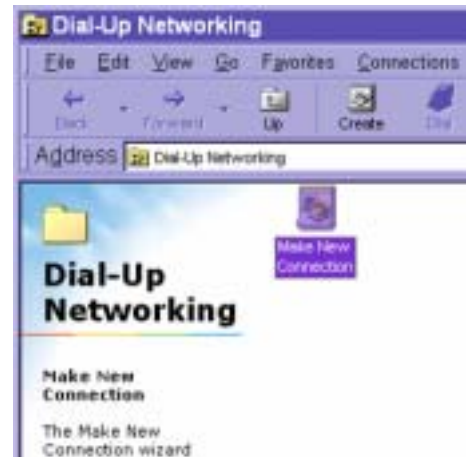

2. Select the device as the newly installed standard 33600 bps modem and click on **Next >**.

3. Just enter arbitrary digits as phone number and click on **Next >**. The phone number here is not important.



4. After clicking on **Finish**, this new connection will display in the Dial-up Networking folder and will be used for null modem connections.

5. Right-click on the newly setup connection icon for entering properties.



6. In the first General page, clear "**Use area code and Dialing Properties**" option and click on .

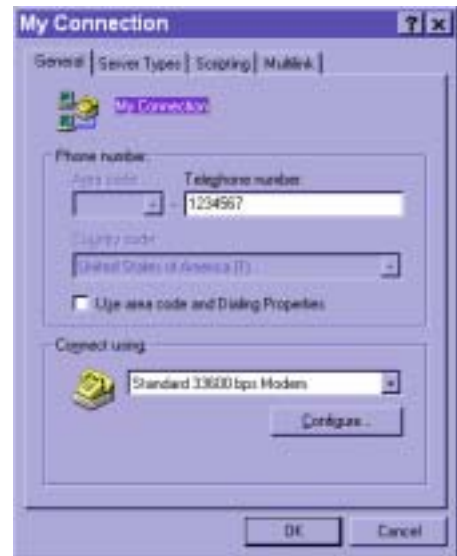

7. Select 115200 as the speed and click on .



8. On the second page, only check "**Enable software compression**" and "**ICP/IP**" while leaving others blank. Keep other settings as default values and click on .

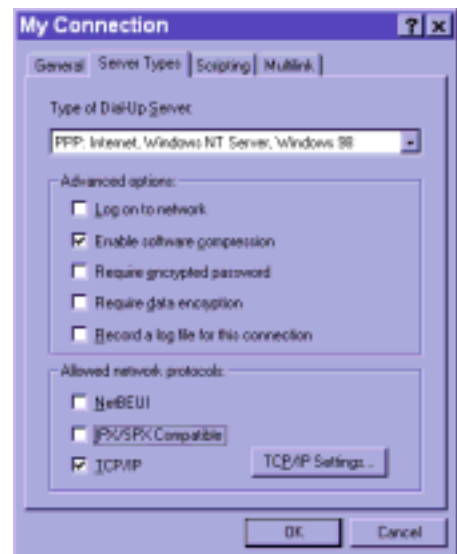

D-Link® Building Networks for People

Now the connection is ready to use for null modem. Double click the newly setup connection. A dialing information window will pop up. Enter "**root**" as user name and the **MAC address** labeled on the bottom side of the box as the password and click on **Connect**. Notice that the letters in the **MAC address** should be capital form. For example, type 'A' instead of 'a'. After some negotiation prompts, a connection status window will show the speed is 115200 bps.



After connection is established successfully, go to the next section, [First access to Video Server](#).

If an error message indicates a hardware error while connecting for the first time, especially in Microsoft Windows 2000 environment, try again to recovery the possible detection failure.

First access to Video Server in null modem mode

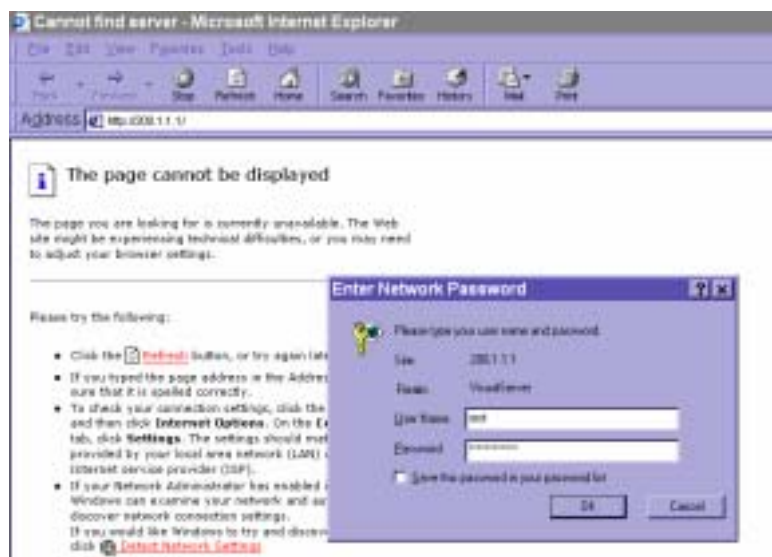

Through direct connection by null modem cable, administrators can connect to "http://200.1.1.1" in the web browser. "200.1.1.1" will be the default IP address of Video Server in dial-in connection; "200.1.1.100" will be the given IP address for the user's PC by Video Server. The user name and password are the same as what was entered during software installation.

After successful authentication, administrators should see the motion pictures in the main page. When using Microsoft Internet Explorer, administrators must allow installing a plug-in provided by Video Server additionally prior to viewing motion pictures.

Change initial password of administrator

For best security, administrators must change the password on the security page of configuration immediately. After changing the password, the browser will display the authentication window again to confirm the new password.

Manage user privilege

Administrators can add up to twenty user profiles in the Security option. While Video Server accepts dial-in connection and acts as a server, the user name and password used in dialing are the same as what is stored in the user database managed for web access. Any managed user can be authorized during PPP negotiation and access web pages. However, only administrators can access the configuration page.

Complete network settings

Basically the null modem is used to setup the later attached modem where Ethernet is not available. Refer to the modem setting in the COM2 section for details about ISP information. After everything is set and saved, turn off Video Server and replace the null modem cable with modem for dial-up network. Since the null modem connection is used to configure Video Server in advance for modem connection, administrators cannot connect again without restarting the system.

First access to Video Server in modem mode

If the dial-out is not prohibited and the attached modem is recognized, Video Server will send out the system startup log and connection log by email or FTP according to user's settings as soon as the system is ready. That can be used to verify if the settings work. Then Video Server will always wait for someone to dial in. To dial in Video Server, setup a connection in dialup network on PC where the phone number is the phone line of Video Server. After connecting successfully, start the Web browser and connect to "*http://200.1.1.1*". In this case, Video Server runs as a dial-up server and assigns the IP address of "**200.1.1.100**" to the PC at the other end. While seeing the authentication message window, type "**root**" as user name and the **MAC address** of Video Server as the initial password. The point-to-point connection allows users connecting Video Server for surveillance at any time.

If the administrator has setup some conditions in the application Web page or the script file, Video Server will automatically dial out based on the administrator's configuration. Refer to the Application section in the Chapter Definitions of Configuration for special security applications.

How to Use

Open your familiar web browser and connect to Video Server just like a general web site and the video will present on demand. Make sure the web address of the target Video Server is accurate.

Authentication

After opening the Web browser and typing in the URL of Video Server, a dialogue window will pop out to request a username and password. For administrator's initial usage of Video Server, enter the username as "**root**" and the password as the **MAC address** in capital letters. The **MAC address** can be found on the labels under the body of Video Server and the top side of the carton. The primary users will be allowed to enter as soon as the administrator finishes adding user profiles. Upon successful authentication, the main page will be displayed.

For demonstration purpose, enter the Demo Web page of configuration to activate the demo account and choose permitted services. Once the demo account is setup, any one may watch the video by using "**demo**" as user name while ignoring the password. Different from primary users, the demo account has certain limitations that are determined by administrators.

In the figure, the foreground is the login window and the background shows the message when authentication fails. The user may check the option to save the password for future convenience.

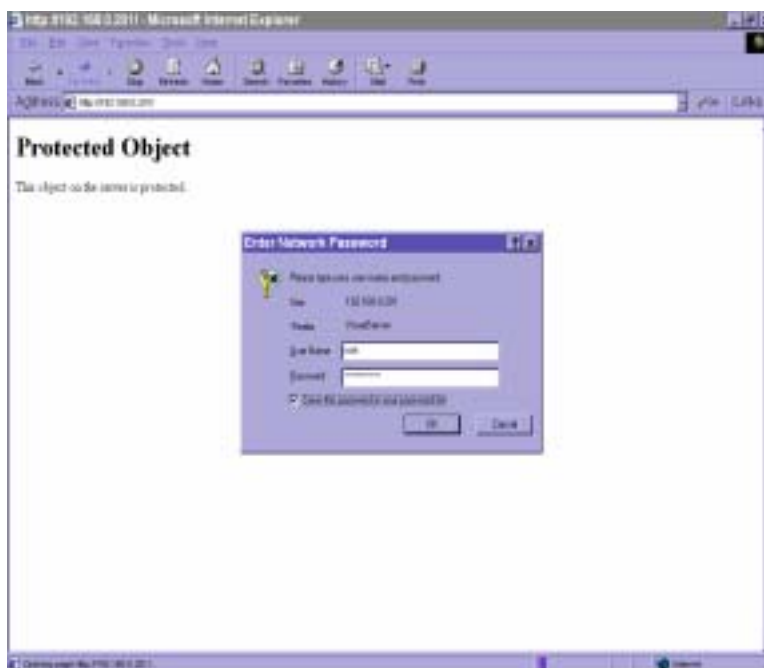

Installing Plug-in

If it is initial access to Video Server via the Web browser supporting server push, the motioned pictures will display directly. If the Web browser is Internet Explorer in Windows, users will be asked to install a new plug-in that is provided by Video Server. This plug-in has been registered for certificate and is used to display motioned pictures in the Internet Explorer. Users may click on to install the plug-in. If the web browser does not allow the user to install, check the security option to lower security levels or contact network supervisors.

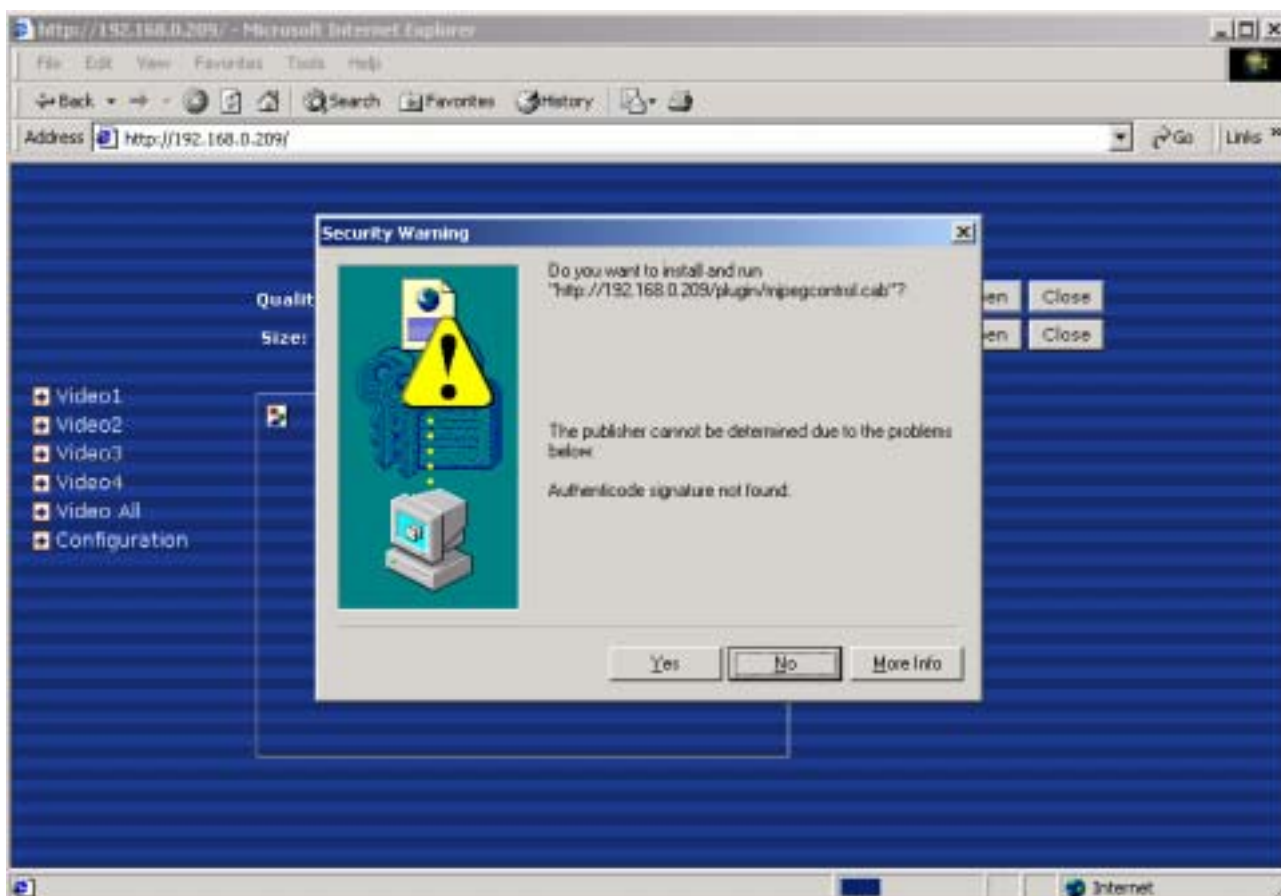

Main Page

Basic functions are displayed in main entrance page of Video Server. The first figure below is graphic mode that has better visual effect and the second one is text mode that will shorten download time. The main page may look different depending on the PTZ driver or the privilege of the user.

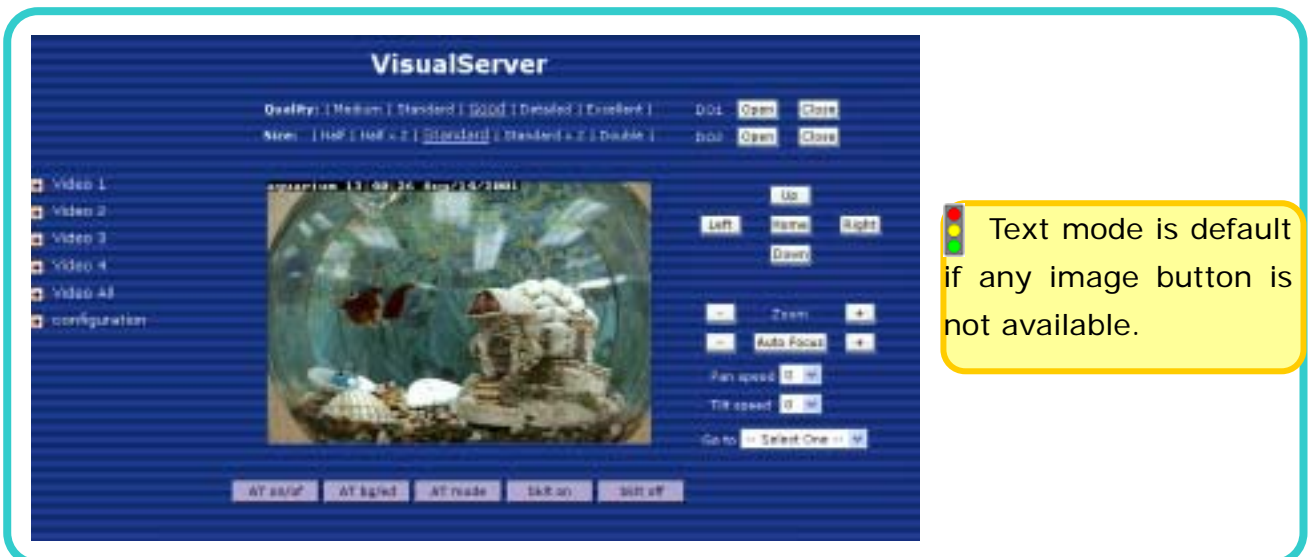

Video input selection

Switch the video source among up to four cameras connected to Video Server. When clicking on the quad display button, a special quad display of all video inputs is available for simultaneous monitoring. The picture refresh rate of quad display is slower than the single input because it takes time to capture the valid image after changing the video source. The actually appearing buttons depend on the system settings.

Video quality selection

It allows users to adjust the video quality for speed or smoothness. The performance is also subject to the network bandwidth and the number of users. Five options are available to be chosen from "**Medium**" to "**Excellent**". "**Medium**" quality means the picture has the quickest refresh rate but the worst image quality and "**Excellent**" quality means the picture has the slowest refresh rate but the best image quality.

Video size selection

It allows users to adjust the image size with consideration of bandwidth and image resolution. Five options are available including "**Half**", "**Half×2**", "**Standard**", "**Standard×2**" and "**Double**". "**Half×2**" consumes the same bandwidth as "**Half**" but has the same size with "**Standard**". Of course the visual effect is worse than "**Standard**". "**Standard×2**" compared to "**Double**" is similar to the case. "**Half×2**" is especially suits in the low bandwidth environment like a dial-up network. To fit into the small image area, timestamp will be skipped in "**Half**" and "**Half×2**" modes.

While in the quad display mode, "**Half**" means the image is composed of half size image of each channel. "**Standard (fast)**" will have higher frame rate and "**Standard (clear)**" will have higher resolution image.

System configuration

There is a button or text link under video buttons for system configuration that only appears in administrators' main page.

External digital output control

There may be two remote control buttons for each digital output on the main page. If

there are external devices attached to digital outputs, administrators or permitted users can click on **Open** to short "Common" and "Normal Open" pins of the digital output or click on **Close** to short "Common" and "Normal Close" pins of the digital output. To know more about the digital outputs for external devices, refer to the rear panel introduction of the Chapter [Physical Description](#).

Motorized camera control

If there is any serial device like motorized camera attached and correctly setup to either COM port, the control panel will appear on permitted users' main page. The effective buttons will change color when users move the cursor over. Users can control the motorized camera in pan and tilt direction as well as zoom and focus. The home button can return the camera to the center position if the camera supports this command. Besides the near and far control in focus, an "AUTO" button is provided for setting auto focus mode. To move the motorized camera more precisely, speed control of pan and tilt allows users to fine tune the aiming position. Users also can directly click on any point in the image to force the motorized camera to focus on it. Users can pull down the list of preset locations to choose any one to move the camera to the preset location that is pre-defined by administrators. The detailed configurations are described in the related section in the Chapter [Definitions of Configuration](#).

Custom camera commands

There are at most five buttons of custom commands for users to control the attached motorized cameras in addition to the default pan, tilt, zoom and focus control. The custom commands mean that administrators can setup some special commands like activating or deactivating the wiper of dome according to the user's manual of the attached motorized device.

System Configuration

Introduction

The system configuration can be easily done remotely on Internet Explorer through the Web interface. There are two wizards in addition to classified categories of system configurations. They can give friendly instructions and facilitate the setup job. Alternately administrators may type directly the URL of system configuration, "*http://<IP address of Video Server>/setup/config.html*", to directly enter the configuration page. If administrators also want to set certain options through the URL, read the relative section in the Chapter [Advanced Usage](#) for reference. Video Server also supports FTP to modify the system configuration file, CONFIG.INI, for technical usage. The details are described in the Chapter [Advanced Usage](#).

Since it is a networking video server, administrators should run "**Setup wizard**" or well configure "**Security**", "**Network**" and "**Video**" at least. To support external serial port devices, configure "**COM1**" and "**COM2**" and then "**Camera Setting**" in "**Video**". To utilize the built-in features of security and web attraction, run "**Application wizard**" or configure "**Application**" and "**Demo**". Besides these features, administrators can adjust the system date and time in "**System**", or have different homepage layout by configuring "**Homepage layout**". Video Server also provides some system maintenance like "**View log file**", "**View parameters**" and "**Factory default**".

Setup Wizard

The setup wizard will guide administrator to enter necessary information including system name, current date and time, administrator's password, video configuration and captions, and network settings. Administrators can exit the procedures anytime to reserve the current configuration. Finally the setup wizard will ask for reboot to validate the changes and administrators can decide to reboot later.

Application Wizard

There are two main applications including surveillance system and web attraction by means of Video Server. The former one will utilize the built-in motion detection and external sensors to integrate with the existing e-mail or FTP server or external alarms to constitute a security system. It also possesses the weekly schedule for timed monitoring. The later one will customize the main page to your personal style and setup accounts for your possible visitors. The application is perfectly constructed and performed on several clicks by your fingertip. Administrators can additionally configure the application parameters in the [Application](#) page of configuration for more advanced usage after using Application wizard.

Definitions of Configuration

System parameters

Change host name

The "**host name**" is used for the homepage title of main page and displays as the title over the video window on the main page. The maximum string length is 40 characters or 20 characters in double-byte-character-systems like Chinese or Japanese.

Adjust date and time

There are three ways to adjust system date and time. The easiest is to make Video Server "**Sync with computer time**". The second "**Manual**" is to set the date and time manually by entering new values. Notice the format in the related field while typing. The third "**Automatic**" is to make Video Server automatically synchronize with timeservers over the Internet every month. It may fail if the assigned **NTP server** cannot be reached or Video Server is within a local network. Leaving the NTP server blank will let Video Server connect to default timeservers. Domain name or IP address format is acceptable as long as DNS server is available. Do not forget setting the "**Time zone**" offset for local settings. Refer to the Appendix C for the time zone of your region. It only affects the hour in NTP method.

Once the settings are changed, click on  to validate changes.

Security privilege

Change root password

To change the administrator's password, type the new password in both text boxes identically. What is typed will be displayed as asterisks for security purposes. The maximum password is 16 characters. After pressing **Save**, the web browser will ask administrators for the new password for access.

Add new users

To add a new user, type the new user's name and password, check respective privilege, and then press **Add** to insert the entry. There are a total of twenty user accounts. Each user can have independent access right of each video channel, external I/O access and camera control.

Edit user's privilege

If the permitted rights of some user has to be changed, pull down the user list to find the user name and press **Edit**. A new window will pop out for administrators to change password and choose different privilege.

Delete existing users

To delete a user, pull down the user list to find the user name to be deleted and press **Delete**. A message window will pop up for confirmation.

Enable snapshot mode for more users

The maximum users that can view Video Server at the same time are twenty. Administrators can check "**Allow more guests with snapshot mode**" to enable the snapshot mode for more users. Then the users over twenty will have the main page with snapshot mode instead of normal motion picture. It is practical for web attraction. In such case, configure the "**Snapshot interval**" to achieve better performance. The bigger interval between snapshots, the more users can have snapshot mode work.

Network settings

Fix the IP address

To eliminate incautious mistakes during installation, Video Server will stay in installation mode whenever it starts unless "**Reset network at next boot**" is disabled. This option can also be disabled using the Installer program. Once the option is disabled, Video Server will skip installation at the next boot and the Installer program will not find the installed units. That implies that Video Server cannot be accessed if no one remembers the IP address, except for restoring factory default settings. However, with this option disabled Video Server can automatically operate normally after restarting in case of losing power. This option is ignored in the PPP connection.

Basic network settings

Administrators may need to modify the network settings to fit into existing networks. The subnet mask in some broadband service may differ from the default value 255.255.255.0 and service providers may assign more specific network settings. Administrators should change the configuration to what given by the service provider. The configuration may include "**IP address**", "**Subnet mask**", "**Default router**", "**Primary DNS server**" and "**Secondary DNS server**". After changing network settings, be sure to leave "**Reset network at next boot**" blank to skip next installation when the system restarts. Otherwise those network settings will be erased at the next start.

Bandwidth utilization limit

Each Video Server can be limited in bandwidth utilization by administrators according to its priority and importance of location. "**Bandwidth limit**" is most useful to balance network utilization when multiple Video Server's are installed in the same network. It is more effective than changing image quality only and achieves better performance with adequate image size and quality.

Changing port number of servers

For security or network integration, administrators also can hide the server from the general HTTP port by changing "**HTTP port**" to other than default 80. "**Local FTP server port**" can also be changed to other than default 21. Administrators should have enough network knowledge to change the default port.

E-mail settings



Video Server not only plays the role of server, it will also actively connect to servers outside to send out messages or snapshots. When Video Server starts, it will send out a system log via e-mail as long as the settings are correct rather than upload it via FTP.



Even in modem application, Video Server will send out a connection log whenever it dials out to an ISP or dialup server outside. If the administrator has setup some applications in either event mode or sequential mode, Video Server will send out snapshots once conditions are met. To activate e-mail function, enter correct settings of "**SMTP (mail) server**" and "**Recipient email address**". "**Secondary SMTP (mail) server**" and "**Secondary email address**" are provided for backup connection when the primary one fails. "**Return email address**" is whom the mail will return when the SMTP server rejects upon any failure. Some ISP may reject the mail if the address is invalid.

FTP settings

To send the log files described in the above paragraph via FTP, the SMTP server should be erased. Administrators must enter correct "**Primary FTP Server**", "**Primary FTP user name**" and "**Primary FTP password**". "**Primary FTP remote folder**" is the relative sub-folder in the remote FTP server. If the port of the remote FTP server is changed other than 21, set the real port to "**Primary FTP server port**". If the local network is protected by a firewall to prevent from initiating FTP connection from the remote FTP server, you may be able to connect to the FTP server but unable to put any file due to data channel connection failure. Check "**Primary FTP passive mode**" for passive transfer solution. Another set of "**Secondary**" server settings is also provided for backup connection.

In either e-mail or FTP, the primary server information should be entered first. If the primary server is not set, the related FTP or email will be cancelled. Note that it may take time to connect to the secondary server after the first one fails and it may affect some applications when conditions happen too often.

After everything is set, click on . A warning message will pop out for confirmation. After clicking on , Video Server will automatically restart. If "**Reset network at next boot**" is kept checked, perform software installation again. Otherwise Video Server will boot up according to the new configuration automatically.

 Any change made to this page will make the system restart to validate. Make sure every field is correctly typed before clicking on . If Video Server fails to response due to erratic settings, perform the restore procedures and run software installation.

 Administrators should notice that the basic network settings including IP address, subnet mask, default router and DNS servers will be cleared when the network interface is switched to the other between Ethernet and modem.

Video, camera mapping and motion detection

Enable video channels

Only when the video source is "**Enable**", the related link will be displayed in the main page. It is recommended to disable the video inputs without camera to improve the refresh rate within quad screen function. There are three buttons for "Image setting", "Camera setting" and "Motion detection" regarding to each video channel. The details are described in later paragraphs. The video "Modulation" can be automatically detected by the system or manually selected by administrators. Administrators can choose any video channel to be "Default video source" shown in the main page when users connect at the first time.

Adjust image settings

"**Time stamp**" and "**Text on image**" will be enclosed in image for reference. The timestamp is captured from date and time of Video Server that is maintained by an on-board real-time clock. "**Color**" setting is independent of the connected camera and "**B/W**" option can speed up the encoder a little. "**Default quality**" option here will be the default quality when users first connect to Video Server. "**Default size**" option here will be the default size of video window when users first connect to Video Server. To customize for different camera, administrators can adjust "**Brightness**", "**Contrast**", "**Hue**" and "**Saturation**" for video compensation of each channel. While adjusting, administrators can click on to check prior to the setting in memory. If the adjustment is not good, administrators can click on to restore the original settings without change. To facilitate the settings of four video channels, administrators can click on then every setting in this channel will copy to other channels. Note that the "Text on image" may need to change for each channel. After configuration done, click on to close this window. If parameters are changed without saving, they will be used until the next system startup.

Configure attached motorized camera

In addition to configuring PTZ camera driver in COM1 or COM2 page, administrators have to define the relationship between video channel and camera. If there is any PTZ camera attached, administrators should select the "**Camera type**" as "**PTZ camera**", set the attached COM port and the ID of the PTZ camera. The ID is specific to the camera and necessary for multiple camera control. Refer to the manual of camera for ID settings. After clicking on , the preset function will appear in the lower half of window. There are up to twenty positions can be memorized. Administrators can move the camera and then enter the position name and save. The old "**Preset position**" can also be pulled down to delete.

 The camera control will be activated only when both the attached "COM" port and "Camera Setting" are correctly configured. The camera ID may be relative to some DIP switch on the PTZ camera. Administrators may need to read the manual of the PTZ camera for specific information.

Configure motion detection

Each channel can have its own settings of motion detection independently. The settings including "**Object size**" and "**Sensitivity**" allow administrators fine tune to fit into the environment. The "**Object size**" decides the space ratio of motioned objects over the monitored screen. The "**Sensitivity**" sets the measurable difference between two sequential images that would indicate motion. The larger object size and lower sensitivity will make Video Server ignore small variations in images. While the motion amplitude of some object in the monitored screen is over the settings, a white **M** in red background will indicate at the upper-right corner of the window.

 Motion detection is provided as reference because it is very environment-dependent. Especially working by the very sensitive settings, some triggered events may be considered as false alarms though there is tiny difference happening indeed. It can be affected by florescent light flashing, shadow shifting, and so on.

Set video modulation

There are basically two types of video modulation; one is NTSC and the other is PAL. Administrators can select "AUTO" to make Video Server automatically detect the correct type.

Select default video source

Administrators can choose video channel 1 to 4 or quad screen to be the default video source on the homepage when users connect to Video Server. If the default video source is disabled in the user's privilege, the prohibited screen will display instead.

COM1 port configuration

Choose serial interface

There are two types of serial interfaces supported by COM1 but only one interface can be used at one time. Administrators must set the correct "**Interface mode**" between RS232 and RS485 according to the attached device.

Choose device driver

If the attached device is PTZ driver, administrators should select the appropriate PTZ model. Refer to our Web site for newly supported PTZ drivers. If the attached PTZ camera is not in the support list, administrators can select "**Custom Camera**" to enter the proprietary commands for pan, tilt, zoom and focus control. If it is not a PTZ camera but another serial device like video multiplexer, administrators can select the "**Generic CGI command**" to control the device via CGI commands. See the [URL of External Device Control](#) section in the Chapter [Advanced Function](#) for details.

COM port configuration

After saving the driver type, the COM port configuration will show up for entering the correct settings that depends on the camera type. Refer to the Appendix [Settings for Supported PTZ Cameras](#) for default settings of supported PTZ camera including baud rate, data bits, stop bit and parity bit.

Custom commands

Video Server provides five more custom commands other than general pan, tilt, zoom and preset functions. Administrators can click on  and refer to the instruction manual of the attached device to setup frequently used functions. The "**Command**" should be entered in ASCII format; Video Server will translate it into binary code and send it out through the serial port. For instance, a text string of "8101ABCDEF" will be translated into five bytes of hexadecimal 81, 01, AB, CD and EF. The maximal length of a command string is 60 which is equivalent to 30 hexadecimal bytes. "**Display string**" is for text on command buttons and should be less than 8 characters. If the "**Custom Camera**" is selected, there will be more commands for PTZF regarding to the custom camera.

COM2 port configuration and modem

Choose device driver

There are three types of device drivers that can be attached to COM2. The modem is supported by COM2 more than COM1 but only RS232 interface is supported. Administrators should select the device driver and click on save, then the related configuration will show in the lower half of the page. If the modem is selected, ISP information is necessary.

COM port configuration

After saving the driver type, the COM port configuration will show up for entering the correct settings that depends on the camera type. Refer to the Appendix [Settings for Supported PTZ Cameras](#) for default settings of supported PTZ camera including baud rate, data bits, stop bit and parity bit.

Custom commands

will appear when administrators select PTZ driver. The usage is similar to COM1. If administrators select "**Modem**", refer to the next paragraph for details.

ISP information setup

In PPP interface, a modem option will show instead of camera control 2. Configurations include modem initialization and outside dial-up server. If the users will setup with external sensors and alarms for property security, dial-out is needed to send some snapshot-attached e-mails when the preset conditions are triggered. In such applications, also remember to choose Network option to enter mail server address and recipient's e-mail address. If "**Dialout allowed**" is not checked, Video Server will not send out any snapshots when events occur and the settings except for "**Initial modem command**" in this page will have no effect. The system will preset the attached modem to eliminate echo and mute line sound. To initialize the modem with further commands, type into the edit box. The prefix "AT" should be included.

Administrators should choose an appropriate "**Dial Method**" according to the local POTS environment. An incorrect dialing prefix may cause Video Server to fail when dialing out. "**Redial attempts**" means how many times Video Server should try to connect to each ISP. Setting the value in "**Disconnect after minutes**" will force Video Server to drop the connection when there is no activity on the connection for the specific period. The range of this period is from 1 to 240 minutes, with 0 indicating a continuous connection. Administrators may let Video Server keep the connection for a while to allow connections from outside. The IP address given by the ISP can be taken from the connection log that

DVS-104 User Manual v1.00

is mailed or uploaded when dial-up connection is successful. Setting the value to zero will make Video Server always keep the connection.

Based on the settings of DI/DO in the application, the system will send mails or upload via FTP with image attachment upon the event occurring. In that case Video Server will need a network connection and automatically dial out to the pre-configured server outside. When a connection is successfully established, Video Server will send out a connection log to notify given network settings. For those installations that may switch the network interface between Ethernet and PPP, administrators should notice that the settings of FTP or SMTP servers might be different from what are in an Ethernet environment. If the network interface is changed, administrators may need to configure them in advance.

Video Server will try the second ISP as a backup when the first ISP fails and exceeds the redial attempts. "**ISP phone number**" should be the complete phone number including country code and area code if necessary. "**Login username**" and "**Login password**" are used to pass the PPP negotiation requested by the ISP server. Note that the pair of login name and password is dependent on the ISP and is different from what is used in the authentication process in web access.

Application constitution

Administrators can use combinations of options on the application page to perform many useful security applications. Video Server provides two application modes; one is performed according to the settings on the web page, the other is performed according to the external command script. Though most settings will automatically be done by the Application Wizard, administrators still can adjust the settings from this page.

Weekly schedule

A useful weekly schedule is provided for daily security application. Administrators can select weekdays from Monday to Friday with the daily schedule from 9:00 am to 6:00 pm that no one is at home to perform any event checking. If the security system needs to be installed in office that no one is there during the nights or weekend, administrators just set the time period as above, then check **"All the time except for the above schedule"** for opposite operations.

External command script

Administrators can write a script named **SCRIPT.TXT** to perfectly match the additional software according to the Command Script for Complex Applications section in the Chapter Advanced Functions. After uploading this script to Video Server via FTP, check the option **"Enable the external script file to exclude the following settings"**. Otherwise Video Server will operate according to the settings below.

Event operation

Video Server provides general options for two basic applications, **event operation** for security and **sequential operation** for web attraction. In event operation, administrators have to setup some conditions to check and some actions to happen consequently. The conditions include motion detection on any video channel and the status of any digital inputs. While checking motion in video, administrators should click on the monitored video channel to configure the appropriate parameters. In the newly opened window, percentage of **object size** over whole window and **sensitivity** can be fine tuned to fit into the environment. If any motion is over the settings, an **M** will appear on the upper-right corner of image for indication. The 'M' will appear in the image to indicate some motion is detected as long as **"Show alert in image"** is checked. If there are any sensors attached to the digital inputs, administrators can set the state to fire alarm. There are four states of **"High"**, **"Low"**, **"Rising"** and **"Falling"** plus **"Disable"**. The edge trigger like **"Rising"** or **"Falling"** is generally used to detect the emerging signal from the external sensor. Once any event happens, administrators can select **"DO action"** and/or send snapshots that are taken right at the moment. There is also a

DVS-104 User Manual v1.00

“**Delay second(s) after event**” option to drive some device attached to the digital outputs several seconds after the event happens. If administrators want to receive some snapshots to check the event, select the snapshot channels and check “**Send snapshot while trigger condition(s) match**”. Video Server will take three snapshots of pre-event, the moment of event, and post-event for selected video channels. If the snapshots are not enough, more snapshots can be taken after the event by configuring “**Take snapshot(s)**” and the “**interval after the event**” in unit of tenth second. Three snapshots of each channel can also be downloaded via FTP or HTTP URL. Refer to the [Download Event-triggered Snapshots](#) section for details.

Sequential operation

With this feature, Video Server can upload snapshots periodically to external server as a live video source. The interval can be set from tenth second to several hours. The external server must be setup correctly in the [Network](#) configuration page.

Sending method

Either event mode or sequential mode can select one method between **email** and **FTP**. The companied external server must be setup correctly in advance. If email is chosen, the snapshots of selected video channels will be attached in the emails. If FTP is chosen, administrators can choose to add date and time in the file name of snapshots. If the snapshots are used as the live video source, the date and time suffix can be eliminated to update the same source file.

 The option “Show alert in image” may be set when running application wizard or configuring motion detection. Administrators should manually uncheck it if no indication of motion detection is needed in the image.

Demonstration account

To setup Video Server for demonstration to the public, administrators need to choose the service(s) to be permitted. After checking "**Enable demo account**", users may use "**demo**" as general user name and password is not required. To separate the demo account from primary users can prevent from interfering with the normal operations.

Homepage layout

There are two homepage display modes. One is "**Image mode**" that uses graphics for links; the other is "**Text mode**" that mostly uses text for links.

Image mode

Administrators may easily give Video Server a different presence of homepage. The "**logo graph**" for the system logo at the upper-left corner can be hidden; or the default image from the system memory can be used; or an external resource can be used by assigning a URL. The "**Background graph**" is similar. Default images of the system can be customized but limited by memory size. Images from external resources can be larger and more beautiful but will need more time to load. If the background is skipped, the background color will fill the browser window. Administrators also can give the system logo a "**Logo link**" to connect to another web site while clicked. The "**Font color**" and "**Background color**" can be chosen from sixteen colors as you like. See the [Customize graphics in homepage](#) section in the Chapter [Advanced Functions](#) for how to replace the default images of log, background and buttons of video switch.

Text mode

The "**video string**" for video links can be modified with maximum 16 characters. That will make users more easily know where the cameras installed like "*Main Entrance*", "*Warehouse*" instead of "*video1*", "*video2*". The camera control panel is also replaced by text buttons.

 If any necessary image is lost while homepage layout is image mode, Video Server will switch to text mode automatically.

View log file

There is some useful information in the system log including current system configuration and activity history with timestamp for tracking.

View parameters

The whole system parameters will be categorized listed for administrators to check. The content is the same as CONFIG.INI.

Factory default

It is used to restore the factory default settings. This means any changes made before will be lost and the system will be reset to the initial status as shipping out of the factory. After confirmation, the system will restart and require the software installation to setup the network.

Advanced Functions

Capture Up-to-date Still Images

Get snapshot via URL

Administrator and users can use the specific URL to capture the current still image.

Video channel	URL
Video 1	http://<IP of Video Server>/cgi-bin/video1.jpg[?<param>=<value>]
Video 2	http://<IP of Video Server>/cgi-bin/video2.jpg[?<param>=<value>]
Video 3	http://<IP of Video Server>/cgi-bin/video3.jpg[?<param>=<value>]
Video 4	http://<IP of Video Server>/cgi-bin/video4.jpg[?<param>=<value>]
Quad of all	http://<IP of Video Server>/cgi-bin/videoall.jpg[?<param>=<value>]

Additional parameters:

param	value	Description
quality	1	Medium
	2	Standard
	3	Good
	4	Detailed
	5	Excellent
size	1	Half
	2	Standard
	3	Double

Get snapshot via FTP

Administrator and users can log-in the FTP daemon of Video Server to download the refreshed JPEG image. The user name and password are as same as what in web access. The zero file size in file directory means it is captured by request.

Video channel	File name
Video 1	video1.jpg
Video 2	video2.jpg
Video 3	video3.jpg
Video 4	video4.jpg
Quad of all	videoall.jpg

Get Continuous Images

Select video source and quality and size

[/cgi-bin/video.jpg\[?<param>=<value>\]](#)

param	value	Description
cam	1	Video 1
	2	Video 2
	3	Video 3
	4	Video 4
quality	1	Medium
	2	Standard
	3	Good
	4	Detailed
	5	Excellent
size	1	Half
	2	Standard
	3	Double
	4	Half x 2
	5	Standard x 2

Display all video

[/cgi-bin/quad.jpg\[?<param>=<value>\]](#)

param	value	Description
quality	1	Medium
	2	Standard
	3	Good
	4	Detailed
	5	Excellent
size	1	Half
	2	Standard (fast)
	3	Standard (clear)
	4	Half x 2

Video Embedded in Customers' Homepage

In addition to the URL, some scripts should be added to download a plug-in for motion pictures. The following example simply displays title text and a real-time video window in Internet Explorer or Netscape. The user name and password should be configured in advance. Those who are familiar with HTML can easily add more components or rewrite a more vivid and useful homepage.

```
<html>
<head><title>Video Server Sample Page</title></head>
<body>
<h2>Video Server Sample Page</h2>
<script language="JavaScript">
<!--
if ((navigator.appName == "Microsoft Internet Explorer")&&(navigator.platform !=
"MacPPC")) {
    document.write("<OBJECT ID=\"MjpegControl\" WIDTH=352 HEIGHT=240");
    document.write(" CLASSID=\"CLSID: EAA105FE-7BBD-4196-8B96-D46743894195
\" ");
    document.write("CODEBASE=\"http://username:password@192.168.0.201/plugin
/mjpegcontrol.cab#version=1,0,0,4\">");
    document.write("<PARAM NAME=\"VSize\" VALUE=\"2\">");
    document.write("<PARAM NAME=\"Uri\" VALUE=\"http://username:password@
192.168.0.201/cgi-bin/video.jpg");
    document.write("?cam=1&quality=3&size=2\">");
    document.write("</OBJECT>");
} else {
    document.write("<img width=352 height=240");
    document.write("src=\"http://192.168.0.201/cgi-bin/video.jpg?cam=1&quality=3
&size=2\">");
}
//-->
</script>
</body>
</html>
```

Download Event-triggered Snapshots

There are twelve video image files for four video channels of three stages: pre-alarm, the moment when triggered and post-alarm. Only the snapshots captured by the last event are preserved. Administrator and users can use FTP or URL to get the saved snapshots. They can also be browsed from the application page in system configuration.

Get triggered snapshots via URL

/cgi-bin/snapshot.jpg?file= <value>

Video channel	Video 1	Video 2	Video 3	Video 4
Snapshot stage				
snapshot before event	pre1	pre2	pre3	pre4
snapshot upon event	trg1	trg2	trg3	trg4
snapshot after event	pos1	pos2	pos3	pos4

Get triggered snapshots via FTP

File name	Pre-alarm	Upon alarm	Post-alarm
Video 1	v1pre.jpg	v1trg.jpg	v1pos.jpg
Video 2	v2pre.jpg	v2trg.jpg	v2pos.jpg
Video 3	v3pre.jpg	v3trg.jpg	v3pos.jpg
Video 4	v4pre.jpg	v4trg.jpg	v4pos.jpg

Uploading Snapshots Periodically

Upload snapshots to external FTP server

In sequential mode, Video Server will send out snapshots according to interval and period settings. If snapshot files are intended for quick updates, it is better to skip date and time suffix. The file name will then be video1.jpg, video2.jpg, video3.jpg and video4.jpg for four channels. If the snapshots are used for occasional monitoring, suffix with date and time can help administrators classify them easily.

Send snapshots to external SMTP (email) server

Comparing to the FTP method, email will induce more delay. But the email can notify users for prompt action.

Customize Graphics in Homepage

While in text mode, there is a small icon named BTN_TEXT.GIF preceding with each link that can be changed by administrators. While in image mode, the default method will use the image stored in Flash memory. The followings are the referenced file name and size limitation of each stored images. Administrators may customize preferred image under the size limit and put to the specific name via FTP. Administrators can download the original images before upload for backup.

Object	File name	Maximal size
Logo	logo.gif	Logo and background share 8000 bytes
Background	back.gif	Logo and background share 8000 bytes
Link icon	btn_text.gif	2000 bytes
Camera 1 button	btn_cam1.gif	5000 bytes
Camera 2 button	btn_cam2.gif	5000 bytes
Camera 3 button	btn_cam3.gif	5000 bytes
Camera 4 button	btn_cam4.gif	5000 bytes
Camera All button	btn_cama.gif	5000 bytes
Configuration	btn_conf.gif	5000 bytes

Usage via FTP is illustrated as below.

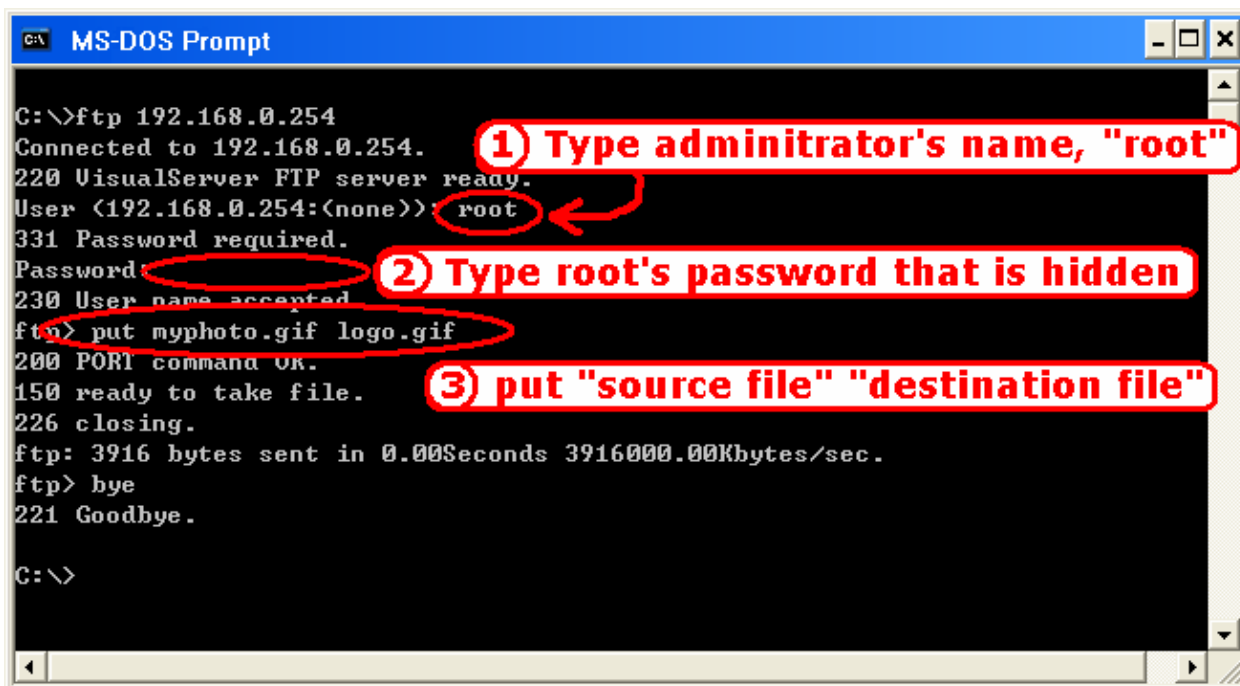

```
C:\>ftp 192.168.0.254
Connected to 192.168.0.254.
220 VisualServer FTP server ready.
User (192.168.0.254:(none)): root
331 Password required.
Password:
230 User name accepted.
ftp> put myphoto.gif logo.gif
200 PORT command OK.
150 ready to take file.
226 closing.
ftp: 3916 bytes sent in 0.00Seconds 3916000.00Kbytes/sec.
ftp> bye
221 Goodbye.

C:\>
```

1) Type administrator's name, "root"

2) Type root's password that is hidden

3) put "source file" "destination file"

Command Script for Complex Applications

Besides the application wizard, Video Server provides a more professional command script for advanced applications. The command script will be executed exclusively with the settings in Application page of system configuration except for the weekly schedule. To build the advanced application, follow the steps below.

1. Use any text editor to edit the appropriate command script according to the command format. The script size cannot exceed 500 bytes.
2. Save the script as a file named "SCRIPT.TXT".
3. Use FTP with administrator's privilege to upload the script file.
4. Enter the Application page in system configuration to define the time period in weekly schedule. If it is supposed to run any time, keep the original settings but check the option "All the time except for the above schedule".
5. Check the option "Enable the external script file to exclude the following settings" to activate the command script.

Command format

[Event]["Operator"Event].....=[Action][+Action].....;

Event

["Digital Input Number""Digital Input State"]

["M" "Channel Number..."]

["Channel Number""Video Input State"]

Operator

"+": (OR)

"*": (AND)

Action

[("Delay Time")"Digital Output Number""Digital Output State"]

["V""Channel Number""P""Preset Location Number"]

["W"{"IP": "Port"}{"Message"}]

["U""Method"]

["S""Channel Number..."]

["N"{"filename"}];

Parameter explanation

Item between brackets means optional but at least one item should exist.

"Digital input number": 1 ~ 4

DVS-104 User Manual v1.00



Building Networks for People

"Digital input state":	H (high), L (low), / (low to high), \ (high to low)
"M":	motion detection event.
"Channel Number":	A, B, C, D for channel 1, 2, 3, 4
"Video input state":	/ (signal from loss to presence), \ (signal from presence to loss), X (as long as signal loss)
"Digital output number":	1 ~ 2
"Digital output state":	C (NC), O (NO)
"V":	set video channel to go to preset location
"P":	set preset location number to go to preset location
"W":	send warning to server
"IP":	server IP
"Port":	server port
"Message":	texts to be sent to the server
"U":	upload snapshots
"Method":	'F' is by FTP, 'M' is by e-mail
"S":	take snapshot on channels
"N":	define the format of the filename
","	end of line

The filename format is,

%c	channel number
%a	image characterization (pre, trg, pos)
%y	year
%M	month
%d	day
%h	hour
%m	minute
%s	second
%t	tenth second

Practical examples

Command line	Description
M12=1C;	When any motion is detected on channel 1 or 2, "Normal Close" of relay output 1 will short with "Common".
1H*2\=(5)1O;	When DI1 high accompanied with DI2 transient from high to low, "Normal Open" of relay output 1 will short with COMMON in 5 seconds.
B\C\D=W{192.168.0.1:6000}{no signal!};	If there is no signal on channel 2 or 3 or 4, a message "no signal!" will be sent to port 6000 of 192.168.0.1 once.
2H=V1P15;	When sensor input 2 is high, drive the camera mapped to video 1 to go to preset location 15.
M34=UF+S1234+N {video%c%a@%y %M%d%h%m%s} ;	If any motion is detected on channel 3 or 4, upload snapshots taken on channel 1, 2, 3 and 4. If an event triggered at 19:05:30 2002/10/15, the snapshot files will be named as, video1pre@20021015190530.jpg, video2pre@20021015190530.jpg video3pre@20021015190530.jpg, video4pre@20021015190530.jpg video1trg@20021015190530.jpg, video2trg@20021015190530.jpg video3trg@20021015190530.jpg, video4trg@20021015190530.jpg video1pos@20021015190531.jpg, video2pos@20021015190531.jpg video3pos@20021015190531.jpg, video4pos@20021015190531.jpg

 The script file is limited to maximum 500 characters. The actual performance will depend on the complexity of the command script. Administrators should reduce the redundant check as possible. Overload conditional check and heavy actions may retard the system operation.

URL for External Device Control

Query status of digital inputs

[/cgi-bin/getdi.cgi](#)

Video Server will return status of four digital inputs in one line.

Drive digital outputs

[/cgi-bin/setdo.cgi?do<number>=<state>](#)

<number>: **1, 2** for DO1 and DO2

<state>: **C, O** denoting Normal Close or Normal Open respectively.

Move motorized camera in PTZ direction

[/cgi-bin/control.cgi?<param>=<value>](#)

param	value	Description
cam	1	Video 1
	2	Video 2
	3	Video 3
	4	Video 4
move	up	Tilt up
	down	Tilt down
	left	Pan left
	right	Pan right
	home	Return to home position
zoom	wide	Zoom in
	tele	Zoom out
focus	near	Focus near
	far	Focus far
	auto	Automatic focus
panspeed	-5 ~ 5	
tiltspeed	-5 ~ 5	

Recall camera position

[/cgi-bin/recall.cgi?cam=<n>&recall=<position>](#)

<n>: video channel from 1 to 4

<position>: the text string of a location that is preset in system configuration.

Refer to [Camera preset configuration URL](#) for preset function.

DVS-104 User Manual v1.00

Transparent Remote Serial Driver

Video Server provides a highly customized control support to third-party serial interface devices aside from PTZ cameras. That means in addition to setting up a custom camera with PTZF commands, users may utilize this mode and introduce a customized homepage to transmit arbitrary user-defined commands from user-side to Video Server. The third-party device connected to the serial port of Video Server will receive the same command sent by the originator. The user only needs to attach the command in ASCII format after the special URL. Video Server will parse the commands and translate into binary code to send out.

Send command to device attached to COM1

</cgi-bin/senddata.cgi?com=1&data=123456,ABCDEF&flush=yes&wait=1000&read=6>

This hyperlink will inform Video Server to send out binary format commands to COM1 with "0x12, 0x34, 0x56" followed by "0xAB, 0xCD, 0xEF". Each comma separates the commands by 200 milliseconds. "flush=yes" means the receive data buffer of COM port must be cleared before read. Then read 6 bytes after waiting for 1000 milliseconds. The read data can be up to 128 bytes and will return as ASCII coded hexadecimal value, e.g., 0x41, 0x42, 0x43 read from COM port will show in returned homepage as 414243 instead of ABC.

Send command to device attached to COM2

</cgi-bin/senddata.cgi?com=2&data=123456,,,ABCDEF>

This hyperlink will inform Video Server to send out binary format command to COM2 with "0x12, 0x34, 0x56" followed by "0xAB, 0xCD, 0xEF" after 600 milliseconds of three comma.

URL of System Maintenance

Download System Log via FTP

Besides viewing the system log from the web page, administrators can download the system log file, SYSTEM.LOG, via FTP. To log into the FTP daemon, enter "root" as the user name and the same administrator's password used in Web access.

Restart System via URL

/cgi-bin/reset.cgi

Restart Video Server without warning.

Restore Factory Default Settings via URL

/cgi-bin/restore.cgi

Video Server will automatically restart after restoring factory default configurations.

Configure System via FTP

Administrators can use FTP to configure Video Server much quicker than Web page especially for multiple targets. To configure system via FTP, first download the parameter file, CONFIG.INI, to customize each field according to the environment and then upload back to validate the new settings. To log into the FTP daemon, enter "root" as the user name and the same password used when connecting to the Web server. The **MAC address** of Video Server is the password for the initial access.

The file is composed of eight categories: [SYSTEM], [LAYOUT], [NETWORK], [VIDEO], [SERIAL1], [SERIAL2], [ALERT], and [DEMO]. The category name in brackets should be in upper case. The item name in angle braces should be in lower case. Some items related to disable/enable should use the keywords "YES"/"NO". The number zero entry in <user name> and <user password> is for administrators, i.e. "root". Basically Video Server will restart automatically as soon as the file is accepted. If administrators want to cancel the reboot procedure, set the first item, <reset system> to NO. It will take effect once only and always show YES in the download file.

A sample CONFIG.INI is attached below. *The italic text* following each line describes the characteristic of the field and ***the bold italic characters*** are the options of the field.

Video Server Initial Configuration File

[SYSTEM]

<reset system>

YES

or **NO**

<host name>

Video Server

string of maximum 40 characters

<serial number>

0002D1040011

read-only

<software version>

DVS-104-VVTK-0200C

read-only

<current date>

2003/01/01

read-only

<current time>

12:34:56

read-only

<time zone>

0

*from **12** to **-12***

<user name>

(0)root

read-only

(1)

string of maximum 16 characters

(2)

the followings are as same as the above

(3)

(4)

(5)

(6)

(7)

(8)

(9)

(10)

(11)

(12)

(13)

(14)

(15)

(16)

(17)

(18)

(19)

(20)

<user password>

(0)0002D1040011

(1)

(2)

(3)

(4)

(5)

(6)

(7)

(8)

(9)

(10)

(11)

(12)

(13)

(14)

(15)

(16)

(17)

(18)

(19)

(20)

<more guests enabled>

NO

<more guests interval>

0

[LAYOUT]

<layout type>

1

1

<background color>

0

<logo type>

1

<background type>

1

<logo source>

http://

*string of maximum 16 characters
the followings are as same as the above*

or **YES** to enable snapshot mode

seconds of snapshot interval

image mode or 0 for text mode

0-black, 1-white, 2-green, 3-maroon, 4-olive, 5-navy, 6-purple, 7-gray, 8-yellow, 9-lime, 10-aqua, 11-fuchsia, 12-silver, 13-red, 14-blue, 15-teal,

default image, or 0 for blank, or 2 from URL

default image, or 0 for blank, or 2 from URL

URL of logo type 2, maximum 80 characters



Building Networks for People

<background source>

http://

URL of logo type 2, maximum 80 characters

<logo link>

http://

reference link of logo, max. 80 characters

<button name>

(0)Video1

used in text mode, max. 16 characters

(1)Video2

used in text mode, max. 16 characters

(2)Video3

used in text mode, max. 16 characters

(3)Video4

used in text mode, max. 16 characters

<com1 speedlink name>

(0)

string of maximum 8 characters

(1)

string of maximum 8 characters

(2)

string of maximum 8 characters

(3)

string of maximum 8 characters

(4)

string of maximum 8 characters

<com2 speedlink name>

(0)

string of maximum 8 characters

(1)

string of maximum 8 characters

(2)

string of maximum 8 characters

(3)

string of maximum 8 characters

(4)

string of maximum 8 characters

[NETWORK]

<install enabled>

YES

*reset IP whenever system boots or **NO***

<ppp enabled>

YES

obsolete

<ethernet address>

00-02-D1-04-00-11

read-only

<host ip>

192.168.0.207

standard IP format

<subnet mask>

255.255.255.0

standard IP format

<gateway ip>

0.0.0.0

standard IP format

<primary name server>

0.0.0.0

standard IP format

<secondary name server>

0.0.0.0

standard IP format

<ntp enabled>

NO

*or **YES***

<network timing server>

IP address or domain name

<smtp mail server>

IP address or domain name

<mail recipient address>

string of maximum 80 characters

<mail return address>

Video Server

string of maximum 80 characters

<backup smtp mail server>

IP address or domain name

<backup mail recipient address>

string of maximum 80 characters

<local ftp port>

21

*or **1024 ~ 65535***

<ftp server>



Building Networks for People

	<i>IP address or domain name</i>
<ftp port> 21	<i>or 1024 ~ 65535</i>
<ftp username>	<i>string of maximum 16 characters</i>
<ftp password>	<i>string of maximum 16 characters</i>
<ftp init path>	<i>string of maximum 40 characters</i>
<ftp passive> NO	<i>or YES</i>
<backup ftp server>	<i>IP address or domain name</i>
<backup ftp port> 21	<i>or 1024 ~ 65535</i>
<bacup ftp username>	<i>string of maximum 16 characters</i>
<backup ftp password>	<i>string of maximum 16 characters</i>
<backup ftp init path>	<i>string of maximum 40 characters</i>
<backup ftp passive> NO	<i>or YES</i>
<http server port> 80	<i>or 1024 ~ 65535</i>
<bandwidth limit> 0	<i>or 64000, 128000, 256000, 512000, 768000, 1000000, 1500000, 2000000</i>
[VIDEO]	
<default video> 1	<i>or 2, 3, 4</i>
<camera modulation> AUTO NTSC	<i>or MANUAL or PAL, indication only while AUTO</i>
<video is open> (0)YES (1)YES (2)YES (3)YES	<i>or NO or NO or NO or NO</i>
<video mapped to COM port> (0)0 (1)0 (2)0 (3)0	
<video mapped to ID> (0)0 (1)0 (2)0 (3)0	<i>depending on the camera depending on the camera depending on the camera depending on the camera</i>
<overlay timestamp> (0)NO (1)NO (2)NO (3)NO	<i>or YES or YES or YES or YES</i>
<caption text> (0)	<i>string of maximum 16 characters</i>



Building Networks for People

(1) *string of maximum 16 characters*
(2) *string of maximum 16 characters*
(3) *string of maximum 16 characters*

<colored video>

(0)YES *or **NO** for monochrome*
(1)YES *or **NO** for monochrome*
(2)YES *or **NO** for monochrome*
(3)YES *or **NO** for monochrome*

<video quality>

(0)75
(1)75
(2)75
(3)75

<default size>

(0)2
(1)2
(2)2
(3)2

<brightness>

(0)0 *-5 ~ 5*
(1)0 *-5 ~ 5*
(2)0 *-5 ~ 5*
(3)0 *-5 ~ 5*

<contrast>

(0)0 *-5 ~ 5*
(1)0 *-5 ~ 5*
(2)0 *-5 ~ 5*
(3)0 *-5 ~ 5*

<hue>

(0)0 *-5 ~ 5*
(1)0 *-5 ~ 5*
(2)0 *-5 ~ 5*
(3)0 *-5 ~ 5*

<saturation>

(0)0 *-5 ~ 5*
(1)0 *-5 ~ 5*
(2)0 *-5 ~ 5*
(3)0 *-5 ~ 5*

[SERIAL1]

<data bits>

0

<stop bits>

0

<parity bits>

0

<baud rate>

0

<ccd model>

0

<uart mode>

RS232

<speedlink commands>

(0)

(1)

(2)

*or **RS485***

string of maximum 80 characters

string of maximum 80 characters

string of maximum 80 characters



Building Networks for People

(3)	<i>string of maximum 80 characters</i>
(4)	<i>string of maximum 80 characters</i>
<custom ccd commands>	
HOME	<i>string of maximum 80 characters</i>
UP	<i>string of maximum 80 characters</i>
DOWN	<i>string of maximum 80 characters</i>
LEFT	<i>string of maximum 80 characters</i>
RIGHT	<i>string of maximum 80 characters</i>
TELESCOPE	<i>string of maximum 80 characters</i>
WIDE	<i>string of maximum 80 characters</i>
NEAR	<i>string of maximum 80 characters</i>
FAR	<i>string of maximum 80 characters</i>
[SERIAL2]	
<data bits>	
8	
<stop bits>	
1	
<parity bits>	
0	
<baud rate>	
0	
<ccd model>	
0	
<uart mode>	
RS232	
<speedlink commands>	
(0)	<i>string of maximum 80 characters</i>
(1)	<i>string of maximum 80 characters</i>
(2)	<i>string of maximum 80 characters</i>
(3)	<i>string of maximum 80 characters</i>
(4)	<i>string of maximum 80 characters</i>
<custom ccd commands>	
HOME	<i>string of maximum 80 characters</i>
UP	<i>string of maximum 80 characters</i>
DOWN	<i>string of maximum 80 characters</i>
LEFT	<i>string of maximum 80 characters</i>
RIGHT	<i>string of maximum 80 characters</i>
TELESCOPE	<i>string of maximum 80 characters</i>
WIDE	<i>string of maximum 80 characters</i>



Building Networks for People

NEAR

string of maximum 80 characters

FAR

string of maximum 80 characters

[ALERT]

<script file enabled>

NO

or YES to activate external script

<motion detection channel enabled>

(0)NO

or YES

(1)NO

or YES

(2)NO

or YES

(3)NO

or YES

<snapshot channel enabled>

(0)NO

or YES

(1)NO

or YES

(2)NO

or YES

(3)NO

or YES

<series snapshot channel enabled>

(0)NO

or YES

(1)NO

or YES

(2)NO

or YES

(3)NO

or YES

<application mode>

0

<visual alert>

NO

or YES

<upload method>

0

<file with time suffix>

YES

or NO

<tenth seconds to snapshot after event>

5

<snapshots taken after event>

1

<percentage of object size over screen>

(0)10

1 ~ 99

(1)10

1 ~ 99

(2)10

1 ~ 99

(3)10

1 ~ 99

<percentage of sensitivity>

(0)95

1 ~ 99

(1)95

1 ~ 99

(2)95

1 ~ 99

(3)95

1 ~ 99

<seconds to snapshot periodically>

0

<time to start snapshot>

00:00:00

24 hours format

<time to stop snapshot>

00:00:00

24 hours format

[DEMO]

<demo enabled>

NO

or YES

<PTZ enabled>



Building Networks for People

- (0)NO *or YES*
- (1)NO *or YES*
- (2)NO *or YES*
- (3)NO *or YES*
- <video is open>
- (0)NO *or YES*
- (1)NO *or YES*
- (2)NO *or YES*
- (3)NO *or YES*

Telnet Commands

Video Server has a Telnet daemon for only administrators to access some seldom used functions. Using any general terminal program to connect to Video Server will prompt the user for a password. Username is not requested here since only administrators can access the Telnet daemon. The password is as same as that used in web access. After logging in, type "*help*" for the command list. If "*debug*" or "*dinote*" is not executed, Telnet will disconnect automatically after being idle for 1 minute.

System core debugging

General activities are recorded into SYSTEM.LOG continuously, but information about abnormal status is not. To look deep into the core debugging information, administrators may type the "*debug*" command. This will cause Video Server to start dumping the detailed debugging information while the system is running. This is useful to examine if any error has occurred when the system operates abnormally. The stored information will be cleared automatically after the dump. Video Server will continue to dump new messages unless the connection is broken. If Telnet is not connected, any messages will be stored until administrators re-login.

Monitor changed status of digital inputs

Typing "*dinote*" will make Video Server send the current status of all digital inputs. After that Video Server will continuously monitor DI status and send messages only when the state has changed. For example, after typing "*dinote*" the terminal will display

DI1=L

DI2=L

DI3=L

DI4=L

and if DI2 changes to H, terminal will display only

DI2=H

Stop information dumping

Typing "*stop*" will cease dumping debug information and the digital input status.

Query status of digital inputs

Typing "*diquery*" will display the status of all digital inputs once.

Set digital outputs

To set digital output 1 to connect NO with COMMON, type "*DO1=O*".

To set digital output 1 to connect NC with COMMON, type "*DO1=C*".

To set digital output 2 to connect NO with COMMON, type "*DO2=O*".

To set digital output 2 to connect NC with COMMON, type "*DO2=C*".

Erase snapshots stored in Flash memory

Typing "*erase image*" will clear all snapshots saved in Flash memory.

Erase logo and graphic buttons

Typing "*erase graph*" will clear all images used on the homepage. If no new images are uploaded, the system will switch to text mode and use default images instead.

Skip installation at next boot

Typing "*lock*" will inform Video Server to fix current network settings. It need not wait for installation during the next boot.

Reset network for new settings

Typing "*unlock*" will make Video Server give up current settings and wait for installation.

Restore factory default settings

Typing "*clear*" will make Video Server restore factory settings but not restart. To validate new settings, type "*reset*" to make the system restart.

Reset system

Typing "*reset*" will make Video Server perform a software reset.

Appendix

A. Troubleshooting

A.1 Power-On-Self-Test

After the power has been turned on, Video Server will perform a self-diagnostic to detect any possible hardware defects. If the power indicator is dim at the beginning, the system fails to proceed further without power. While the POST is proceeding, the status LED indicators will keep blinking interchanged until finished or any fatal error happens. If either status LED indicator is dim at the beginning, the LED may be broken.

Any possible fatal error has a special pattern shown in the following table. LED1 is the one below power indicator and LED2 is the lowest one.

| LED pattern after POST | Failed function | Troubleshooting |
|--------------------------|-------------------------|--|
| LED1 ON and LED2 ON | Ethernet network | <ol style="list-style-type: none"> 1. Check the LINK LED of the attached port on the Ethernet switch or hub. If it is dim, the Ethernet cable may be loose or cross-over. 2. If the cable is OK, the Ethernet controller is broken. Ask your reseller for technical service. |
| LED1 ON and LED2 OFF | Ethernet network | The PCI interface cannot work. Ask your reseller for technical service. |
| LED1 OFF and LED2 ON | Ethernet network | The Ethernet controller is broken. Ask your reseller for technical service. |
| Both LED1 and LED2 blink | Video input | The video decoder is broken. Ask your reseller for technical service. |
| LED1 blink and LED2 ON | System date and time | The real-time clock is broken. Ask your reseller for technical service. |
| LED1 ON and LED2 blink | Camera control via COM1 | The UART controller is broken. Ask your reseller for technical service. |
| LED1 OFF and LED2 blink | Camera control via COM2 | The UART controller is broken. Ask your reseller for technical service. |



Building Networks for People

or modem interface your reseller for technical service.

A.2 System recovery

Video Server provides two auxiliary buttons located on the center of the front panel for system recovery by hardware. The buttons can be used to perform either level of system recovery. "Reset" will force the system restart at any point; "Restore" will restore the default settings from factory and then force the system restart to work at the initial state. Consequently "restore" is generally used to completely recover the system from serious fault in configuration.

RESET

Click on the "RESET" button once. The system will perform the system diagnosis and the software installation may be necessary if the IP address is not fixed. This procedure is as same as removing the power and attaching it again.

RESTORE

When the system seems to respond or operate slowly after changing some settings and administrators hardly enter the configuration to change back the original settings, administrators can perform the "restore" procedure. It is as same as the "factory default" link on the configuration page. To restore the factory default settings, click on the "RESET" button once and then press the "CLEAR" button firmly. The system diagnosis will start right away and the "status" LED will be turn on after system diagnosis to indicate the "CLEAR" button is pressed. The second system diagnosis will start again in several seconds after erasing the system parameters. Administrators can release the "CLEAR" button now and perform the installation for the initialized system.



To reduce the system failure caused by operation error, always read the related sections in this user's manual to prevent from unexpected error caused by wild-guess configuration.

B. Frequently Asked Questions

Q Why can't I see the Video Server in the installer after reboot?

A The installer is only used to install the IP address of Video Server. If the IP address is fixed by checking the option in the installer, the Video Server will no longer appear in the installer.

Q Why can't I connect the Video Server after reboot?

A If the IP address is not fixed, Video Server will always wait for installing command for a valid IP address. That means the previous IP address will not be used if the option in the installer is not checked; or the option in the network configuration is not cleared. The benefit of waiting for a valid IP address by default is that administrators can find the Video Server in the installer to prevent IP conflict. As long as the IP address is confirmed, it is suggested to fix the IP address to make Video Server automatically start up whenever regaining power.

Q What if I forget my password?

A Every access to Video Server needs authentication. If you are not a permitted user, you may view the images or control the camera as long as the demo account is opened. The demo account user may use username as "demo" without any password to access limited features. If you are one of the managed users, you have to ask the administrators for the password. If you are the administrator, there is no way to recover the root password. The only way to regain access to Video Server is to restore the factory settings and reinstall it.

Q Why can I not watch video from Video Server after it is authenticated?

A There are many possible scenarios regarding this problem,

1. If you have just installed Video Server and are unable to watch the video, check if the video input is enabled and the video modulation in Configuration page.
2. If Video Server is well installed and you are accessing Video Server for the first time using Internet Explorer, adjust the security level of Internet Explorer to allow installation of the plug-in.
3. If the problem still exists after adjusting, the current users may be over the system allows.
4. In case that you use demo account, the video may be protected from the public by the administrator.

Q How can I use a name instead of the IP address to connect Video Server?

A To allow users to connect to Video Server through an easily memorized name, the administrators must first configure the name server in his network. Here is an example: the administrator installs the Video Server with a reserved IP address and assigns it with a name in the domain name service, then users can connect to Video Server by typing a name instead of IP address. If there is DHCP service in the network, the IP address must be excluded in the DHCP service to prevent from IP conflict.

Q What is the plug-in for?

A The plug-in provided by Video Server is used to display motion pictures on Internet Explorer that does not support server push technology. If your system does not allow installation of any plug-in software, the security level of web browser may need to be lowered. It is recommended that you consult your network supervisor in your office regarding the adjustment of the security level.

Q Why is the timestamp different from the system time of my PC or notebook?

A The timestamp is based on the system time of Video Server. It is maintained by a real-time clock inside and automatically synchronizes with the time server if Video Server is connected to the Internet and the function is enabled. Differences of several hours may result from the time zone setting.

Q Why does the image not refresh regularly?

A In a modem environment, it is because the bandwidth of PPP connection is far less than Ethernet. If the difference of the timestamp is not stable, adjust the UART FIFO lower in both receiving and transmitting from modem property in the control panel. While in Ethernet, it may be due to time taken in storing snapshots into memory upon events occurring.

Q How many users are allowed to watch Video Server at the same time?

A To achieve the best effect, Video Server will allow twenty users to connect at the same time. Excess users can get an auto-refreshed still image in homepage instead. It is recommended to build another web server to host a large quantity of users by retrieving images from Video Server periodically.

Q How fast is the video rate of Video Server?

A The JPEG codec can process 30 frames per second internally. However the total performance is subject to many coefficients as follows,

1. network throughput,

DVS-104 User Manual v1.00

2. bandwidth share,
3. number of users,
4. number of video inputs are accessed at one time,
5. the complicated objects in view results in larger image file,
6. the level of your PC or notebook which is responsible of displaying images.

In general, the transfer rate in general local network environment can achieve over 200 kilobytes per second and approximately 10 to 20 pictures of normal environment per second. The general frame size is illustrated in the follow table for reference.

| Quality setting | Size of each frame | Bandwidth demand for 30fps |
|-----------------|--------------------|----------------------------|
| Medium | 9.3 kbyte | 2246 kbps |
| Standard | 11.15 kbyte | 2676 kbps |
| Good | 13.76 kbyte | 3303 kbps |
| Detailed | 16.35 kbyte | 3925 kbps |
| Excellent | 20.3 kbyte | 4886 kbps |

Q How can I keep Video Server as private as possible?

A Video Server is designed for surveillance purpose and has many flexible interfaces. The user authentication and special confirmation in installation can keep Video Server from unauthorized access. You may also change the HTTP port to non-public number. You can check system log to examine any abnormal activities and trace the origins.

Q I have a PTZ camera that is not on the supported list. How can I control it?

A Video Server provides a custom camera command interface to control the cameras not supported. The details are described in the manual. Be sure the COM port settings are applied to the camera specification. The camera control cable included is shown in the package content. Prepare your own cable if necessary. The general PTZ command is composed of one start command and one stop command. When editing both commands in the edit box of the configuration page, use comma(s) to separate commands. Each comma represents 200 milliseconds. If the user has some serial control device other than the PTZ camera, the special URL is provided to send the desired commands. For quick access, integrate the URL to another homepage on your own web server.

Q Why can I see image files when I use dir in FTP even if the alarm is not triggered?

A Every time Video Server starts, it will capture the images and save them into memory as v1pre.jpg, v2pre.jpg, v3pre.jpg and v4pre.jpg. If there are previously saved image files that are not retrieved, Video Server will keep them until they are accessed.

Q How will the stored images be processed if Video Server loses power?

A If user has defined the snapshot interval, Video Server will capture images of four video inputs periodically and save them into memory as pre-alarm stage. Once the pre-defined condition is match, the pre-alarm images will be kept and the current images will be saved. The subsequent images will be stored as post-alarm stage. User may retrieve these files either by downloading via FTP or direct Video Server send them in e-mails. That means after monitoring conditions are met, Video Server will keep these image files until user retrieval even if power is lost.

Q If I set Video Server to send e-mails of images whenever the conditions are met, will my e-mail account overflow?

A It is recommended to use transient state rather than steady state. For instance, use 'Rising' and 'Falling' rather than 'High' and 'Low' to let the condition be triggered only when state is changed.

Q Why can I not access Video Server when I setup some options in the application?

A When Video Server is triggered by events, snapshots will take more time to write into FLASH. If the events occur too often, the system will always be busy with storing images. That will make users feel like the system responding too slowly. If it is in sequential mode, the uploading speed depends on the network utilization, server performance, how many channels are monitored and how many users are accessing the video. Once the system is too busy to configure, use the restore factory default and reset button to save the system.

Q I have already set the video inputs to different quality but I still see the old quality setting when I choose Video All.

A Video All is a special feature to be used for quick checking for four cameras at the same time. Internally four images of video inputs are compressed with the same settings based on the first video source.

Q I try to connect my black-and-white and color cameras with Video Server but the image is not good.

A Although Video Server allows users to choose color or black-and-white images for each camera, hybrid camera types may increase video processing time and reduce system performance. While connecting multiple cameras, the same modulation type and color format are recommended.

C. Upgrade System Firmware

Customers can frequently check the appropriate product folder on our web site to download the latest firmware. Only administrators can upgrade the system firmware of Video Server.

Easy way via Upgrade Wizard

Run the Upgrade Wizard included in the product CDROM and proceed by the prompts. Refer to the user's guide of Upgrade Wizard for details.

Alternative via FTP

1. Decompress the compressed file in a local folder. A file named FLASH.BIN should appear.
2. Use the FTP program and change the working directory to the local folder where FLASH.BIN exists.
3. Connect to Video Server with user name as "root" and password.
4. Use the PUT command to upload FLASH.BIN to Video Server. The file size is near 1.5 mega bytes. It will take approximately 2 seconds in a local network, 2 minutes by null modem connection or 6 minutes by modem, but still subject to user's network.
5. After upload is complete, close the connection.
6. If the received FLASH.BIN is checked without error, Video Server will update the software in Flash memory and restart automatically. When Video Server starts writing firmware, both status LED indicators will stay on until system restarts. It takes about 30 to 40 seconds. User must keep the power stable during the update process. After the system restarts, Video Server may need installation depending on whether the "Reset network at next boot" option is enabled or not. After Video Server boots up, reload the web page in the browser.



If power fails during the software upgrade, the program in the memory of Video Server may be destroyed permanently. If Video Server cannot restart properly, ask the dealer for technical service.

D. URL Commands of Video Server

For some customers who already have their own web site or web control application, Video Server can be easily integrated through convenient URL. This section lists the commands in URL format corresponding to the basic functions of Video Server. Some RFC standards related to HTML may be a good reference for implementation of the customized homepage.

Page URL

The configuration page has a frame layout including option list frame and an option page frame. Referenced URL except for the configuration page directs to option page frame only. Some pages, like image quality setting and preset setting, are opened in new windows for preview.

These URLs can be accessed only by administrators.

| Homepage name | Referenced URL |
|--------------------------|----------------------|
| configuration page | /setup/config.html |
| system option | /setup/system.html |
| security option | /setup/security.html |
| network option | /setup/network.html |
| video option | /setup/video.html |
| image quality option | /setup/image.html |
| camera control 1 | /setup/serial1.html |
| camera control 2 / modem | /setup/serial2.html |
| preset PTZ camera | /setup/preset.html |
| custom command setting | /setup/cuscom.html |
| custom camera setting | /setup/custom.html |
| application option | /setup/app.html |
| motion detection setting | /setup/motion.html |
| view snapshots | /setup/snap.html |
| demo option | /setup/demo.html |
| homepage layout option | /setup/layout.html |
| system log | /setup/logfile.html |
| system parameters | /setup/parafile.html |

| | |
|---------------------|---------------------|
| set factory default | /setup/factory.html |
|---------------------|---------------------|

System resource URL

There are some images used on the homepage when the homepage layout is in image mode. Administrators may use the following links to show the images saved in Video Server on another page. To change the logo or the background images referenced by the URL, refer to the homepage layout section in configuration.

| Resource name | Referenced URL |
|--------------------------------|----------------|
| system logo image | /logo.gif |
| background image | /back.gif |
| button image for camera 1 | /btn_cam1.gif |
| button image for camera 2 | /btn_cam2.gif |
| button image for camera 3 | /btn_cam3.gif |
| button image for camera 4 | /btn_cam4.gif |
| button image for quad screen | /btn_cama.gif |
| button image for configuration | /btn_conf.gif |
| icon image for link indicator | /btn_text.gif |

General format of command URL

Every configuration can be set through URL with POST method by administrators only.

<general format>

URL[?[name=value][&name=value].....]

<method>

POST

<authorized user>

root

System configuration URL

URL: [/cgi-bin/system.cgi](#)

| NAME | VALUE | DESCRIPTION |
|--------|--|--|
| host | <text string shorter than 15 characters> | system name |
| method | keep | keep date and time unchanged |
| | auto | use NTP server to synchronize |
| | manu | directly adjust date and time |
| date | <yy/mm/dd> | year, month and date separated by slash |
| time | <hh:mm:ss> | hour, minute and second separated by colon |
| ntp | <domain name or IP address> | NTP server |
| zone | GMT±<n>:00 | time zone, n ranged from 0 to 12 |

Security configuration URL

URL: [/cgi-bin/security.cgi](#)

| NAME | VALUE | DESCRIPTION |
|-----------|--|---------------------------|
| rootpass | <text string shorter than 15 characters> | change root password |
| username | <text string shorter than 15 characters> | add new user |
| userpass | <text string shorter than 15 characters> | new user's password |
| v1allowed | <not required> | allow user to view video1 |
| v2allowed | <not required> | allow user to view video2 |

| | | |
|------------|--|-------------------------------|
| v3allowed | <not required> | allow user to view video3 |
| v4allowed | <not required> | allow user to view video4 |
| ioallowed | <not required> | allow user to control DO |
| ptzallowed | <not required> | allow user to view PTZ panel |
| deluser | <text string shorter than 15 characters> | existing user name |
| slow | <not required> | snapshot mode |
| delay | <integer> | refresh time in snapshot mode |

Network configuration URL

URL: </cgi-bin/network.cgi>

| NAME | VALUE | DESCRIPTION |
|----------|--|-----------------------------------|
| reset | yes | enable installation at next boot |
| | <other than yes> | disable installation at next boot |
| ip | <IP address> | Video Server's IP address |
| subnet | <IP address> | subnet mask |
| router | <IP address> | default gateway |
| domain | <text string shorter than 40 characters> | domain name of Video Server |
| dns1 | <IP address> | primary DNS server |
| dns2 | <IP address> | secondary DNS server |
| smtp1 | <domain name or IP address> | primary SMTP server |
| mailto1 | <text string shorter than 80 characters> | mail recipient address |
| smtp2 | <domain name or IP address> | secondary SMTP server |
| mailto2 | <text string shorter than 80 characters> | mail recipient address |
| return | <text string shorter than 80 characters> | return address |
| http | <number less than 65535> | HTTP port |
| ftp1 | <domain name or IP address> | primary FTP server |
| ftprp1 | <number less than 65535> | FTP server port |
| ftpuser1 | <text string shorter than 15 characters> | user name for primary FTP server |
| ftppass1 | <text string shorter than 15 characters> | password for primary FTP server |

| | | |
|------------|--|---------------------------------------|
| | characters> | |
| ftpfolder1 | <text string shorter than 40 characters> | upload folder in primary FTP server |
| ftp2 | <domain name or IP address> | secondary FTP server |
| ftprp2 | <number less than 65535> | secondary FTP server port |
| ftpuser2 | <text string shorter than 15 characters> | user name for secondary FTP server |
| ftppass2 | <text string shorter than 15 characters> | password for secondary FTP server |
| ftpfolder2 | <text string shorter than 40 characters> | upload folder in secondary FTP server |
| limit | Not limited | use full network bandwidth |
| | 64Kbits/second | use only 64Kbps of bandwidth |
| | 128Kbits/second | use only 128Kbps of bandwidth |
| | 256Kbits/second | use only 256Kbps of bandwidth |
| | 512Kbits/second | use only 512Kbps of bandwidth |
| | 768Kbits/second | use only 768Kbps of bandwidth |
| | 1Mbits/second | use only 1Mbps of bandwidth |
| | 1.5Mbits/second | use only 1.5Mbps of bandwidth |
| | 2Mbits/second | use only 2Mbps of bandwidth |

Video configuration URL

URL: </cgi-bin/video.cgi>

| NAME | VALUE | DESCRIPTION |
|---------|---------------------|--|
| enable1 | <not required> | enable video channel 1 |
| enable2 | <not required> | enable video channel 2 |
| enable3 | <not required> | enable video channel 3 |
| enable4 | <not required> | enable video channel 4 |
| mode | Auto | let Video Server detect video modulation |
| | NTSC | set directly to NTSC type |
| | <other than above> | set directly to PAL type |
| source | <1, 2, 3, 4 or All> | default video channel |

Image quality configuration URL

URL: [/cgi-bin/image.cgi](#)

| NAME | VALUE | DESCRIPTION |
|------------|--|------------------------------|
| cam | <1 ~ 4> | Video channel number |
| time | <not required> | enclose timestamp |
| text | <text string shorter than 15 characters> | enclose caption |
| color | B/W | set encoder to monochrome |
| | <other than B/W> | set encoder to color |
| quality | Medium | lowest resolution |
| | Standard | lower resolution |
| | Good | normal setting |
| | Detailed | higher resolution |
| | Excellent | highest resolution |
| size | Half | set size to half |
| | Standard | set size to standard |
| | Double | set size to double |
| | Half x 2 | set size to half x 2 |
| | Standard x 2 | set size to standard x 2 |
| brightness | <-5 ~ 5> | adjust brightness of image |
| contrast | <-5 ~ 5> | adjust contrast of image |
| hue | <-5 ~ 5> | adjust hue of image |
| saturation | <-5 ~ 5> | adjust saturation of image |
| preview | <not required> | not save the parameters |
| restore | <not required> | recall the original settings |
| save | <not required> | save the parameters |

COM 1 configuration URL

URL: </cgi-bin/serial1.cgi>

| NAME | VALUE | DESCRIPTION |
|-----------|--------------------|-----------------------------|
| interface | RS232 | switch COM1 to RS232 |
| | <other than RS232> | switch COM1 to RS485 |
| detect | generic | accept generic CGI commands |
| | none | no drivers |
| driver | Sony VISCA | |
| | Canon VCC1 | |
| | Canon VCC3 | |
| | Canon VCC4 | |
| | DynaDome/SmartDOME | |
| | Pelco D protocol | |
| | Lilin PIH-7x00 | |
| | Ernitec | |
| | Custom Camera | third party PTZ camera |

COM 2 configuration URL

URL: </cgi-bin/serial2.cgi>

| NAME | VALUE | DESCRIPTION |
|---------------|--|---|
| detect | generic | accept generic CGI commands |
| | modem | use modem |
| | none | no drivers |
| driver | Sony VISCA | |
| | Canon VCC1 | |
| | Canon VCC3 | |
| | Canon VCC4 | |
| | DynaDome/SmartDOME | |
| | Pelco D protocol | |
| | Lilin PIH-7x00 | |
| | Ernitec | |
| Custom Camera | third party PTZ camera | |
| dialout | yes | allow Video Server dialing out on event |
| | <other than yes> | no dial-out allowed |
| method | Tone (ATDT) | make modem dial in tone |
| | Pulse (ATDP) | make modem dial in pulse |
| reatt | <integer> | redial attempts |
| discon | <integer> | minutes delay before disconnection |
| init | <text string shorter than 40 characters> | command to initialize modem |
| phone1 | <text string shorter than 40 characters> | phone number of primary ISP |
| user1 | <text string shorter than 40 characters> | user name for primary ISP |
| pass1 | <text string shorter than 40 characters> | password for primary ISP |
| phone2 | <text string shorter than 40 characters> | phone number of secondary ISP |
| user2 | <text string shorter than 40 characters> | user name for secondary ISP |
| pass2 | <text string shorter than 40 characters> | password for secondary ISP |

Camera custom command configuration URL

URL: </cgi-bin/cuscom.cgi>

| NAME | VALUE | DESCRIPTION |
|-------|--|---|
| str11 | <text string shorter than 8 characters> | button name of custom command 1 of COM1 |
| str12 | <text string shorter than 8 characters> | button name of custom command 2 of COM1 |
| str13 | <text string shorter than 8 characters> | button name of custom command 3 of COM1 |
| str14 | <text string shorter than 8 characters> | button name of custom command 4 of COM1 |
| str15 | <text string shorter than 8 characters> | button name of custom command 5 of COM1 |
| com11 | <text string shorter than 80 characters> | custom command 1 of COM1 |
| com12 | <text string shorter than 80 characters> | custom command 2 of COM1 |
| com13 | <text string shorter than 80 characters> | custom command 3 of COM1 |
| com14 | <text string shorter than 80 characters> | custom command 4 of COM1 |
| com15 | <text string shorter than 80 characters> | custom command 5 of COM1 |
| str21 | <text string shorter than 8 characters> | button name of custom command 1 of COM2 |
| str22 | <text string shorter than 8 characters> | button name of custom command 2 of COM2 |
| str23 | <text string shorter than 8 characters> | button name of custom command 3 of COM2 |
| str24 | <text string shorter than 8 characters> | button name of custom command 4 of COM2 |
| str25 | <text string shorter than 8 characters> | button name of custom command 5 of COM2 |
| com21 | <text string shorter than 80 characters> | custom command 1 of COM2 |
| com22 | <text string shorter than 80 characters> | custom command 2 of COM2 |

| | | |
|-------|--|--------------------------|
| com23 | <text string shorter than 80 characters> | custom command 3 of COM2 |
| com24 | <text string shorter than 80 characters> | custom command 4 of COM2 |
| com25 | <text string shorter than 80 characters> | custom command 5 of COM2 |

Camera preset configuration URL

URL: </cgi-bin/preset.cgi>

| NAME | VALUE | DESCRIPTION |
|---------|--|------------------------|
| com | 1, 2 | Com port number |
| cam | <1 ~ 4> | Video channel number |
| camtype | fixed | fixed camera |
| | cammap | PTZ camera |
| id | <integer> | camera id |
| addpos | <text string shorter than 40 characters> | add preset position |
| delpos | <existing position name> | delete preset position |

Custom camera configuration URL

URL: </cgi-bin/custom.cgi>

| NAME | VALUE | DESCRIPTION |
|---------|--|----------------------------------|
| baud1 | <integer> | set baud rate of COM1 |
| data1 | <integer> | set data bits of COM1 |
| stop1 | 1 | set 1 stop bit of COM1 |
| | 2 <other than 1> | set 2 stop bits of COM1 |
| parity1 | None | set parity check of COM1 to none |
| | Odd | set parity check of COM1 to odd |
| | Even | set parity check of COM1 to even |
| up1 | <text string shorter than 80 characters> | tilt up command string of COM1 |
| down1 | <text string shorter than 80 characters> | tilt down command string of COM1 |
| left1 | <text string shorter than 80 characters> | pan left command string of COM1 |
| right1 | <text string shorter than 80 characters> | pan right command string of COM1 |
| home1 | <text string shorter than 80 characters> | home command string of COM1 |
| tele1 | <text string shorter than 80 characters> | zoom in command string of COM1 |
| wide1 | <text string shorter than 80 characters> | zoom out command string of COM1 |
| baud2 | <integer> | set baud rate of COM2 |
| data2 | <integer> | set data bits of COM2 |
| stop2 | 1 | set 1 stop bit of COM2 |
| | 2 <other than 1> | set 2 stop bits of COM2 |
| parity2 | None | set parity check of COM2 to none |
| | Odd | set parity check of COM2 to odd |
| | Even | set parity check of COM2 to even |
| up2 | <text string shorter than 80 characters> | tilt up command string of COM2 |
| down2 | <text string shorter than 80 characters> | tilt down command string of COM2 |
| left2 | <text string shorter than 80 characters> | pan left command string of COM2 |

| | | |
|--------|--|----------------------------------|
| right2 | <text string shorter than 80 characters> | pan right command string of COM2 |
| home2 | <text string shorter than 80 characters> | home command string of COM2 |
| tele2 | <text string shorter than 80 characters> | zoom in command string of COM2 |
| wide2 | <text string shorter than 80 characters> | zoom out command string of COM2 |

Application configuration URL

URL: </cgi-bin/app.cgi>

| NAME | VALUE | DESCRIPTION |
|-----------|---------------------------------------|-------------------------------------|
| sun | <not required> | set Sunday in weekly schedule |
| mon | <not required> | set Monday in weekly schedule |
| tue | <not required> | set Tuesday in weekly schedule |
| wed | <not required> | set Wednesday in weekly schedule |
| thu | <not required> | set Thursday in weekly schedule |
| fri | <not required> | set Friday in weekly schedule |
| sat | <not required> | set Saturday in weekly schedule |
| sbegin | <hh:mm:ss> | time to start in weekly schedule |
| send | <hh:mm:ss> | time to stop in weekly schedule |
| inv | <not required> | set inverse mode in weekly schedule |
| enfile | <not required> | enable script file |
| emode | <not required> | event operation |
| showalert | <not required> | show alert in image |
| mdch1 | <not required> | enable motion detection on video 1 |
| mdch2 | <not required> | enable motion detection on video 2 |
| mdch3 | <not required> | enable motion detection on video 3 |
| mdch4 | <not required> | enable motion detection on video 4 |
| di1 | High, Low, Rising, Falling or Disable | DI1 condition |
| di2 | High, Low, Rising, Falling or Disable | DI2 condition |
| di3 | High, Low, Rising, Falling or Disable | DI3 condition |
| di4 | High, Low, Rising, Falling or Disable | DI4 condition |

| | | |
|----------|----------------------|--|
| | Disable | |
| delay | <integer> | delay time of DO after event |
| do1 | High, Low or Disable | DO1 action |
| do2 | High, Low or Disable | DO2 action |
| eventch1 | <not required> | take snapshots on ch1 while event happen |
| eventch2 | <not required> | take snapshots on ch2 while event happen |
| eventch3 | <not required> | take snapshots on ch3 while event happen |
| eventch4 | <not required> | take snapshots on ch4 while event happen |
| dura | <integer> | snapshots taken after event |
| inter | <integer> | tenth seconds interval after the event |
| mdmode | <not required> | enable motion detection(emode should set) |
| smode | <not required> | sequential mode application |
| sinter | <integer> | tenth seconds interval for sequential mode |
| smethod | mail | upload snapshots by email |
| | ftp | upload snapshots by FTP |
| suffix | <not required> | FTP file with date and time suffix |

Motion detection configuration URL

URL: [/cgi-bin/motion.cgi](#)

| NAME | VALUE | DESCRIPTION |
|------|-----------|------------------------|
| cam | <1 ~ 4> | Video channel number |
| per | <integer> | object size percentage |
| sen | <integer> | sensitivity percentage |

Demo configuration URL

URL: [/cgi-bin/demo.cgi](#)

| NAME | VALUE | DESCRIPTION |
|---------|----------------|--|
| open | <not required> | enable demo account |
| camctr1 | <not required> | allow demo user to control PTZ camera on video 1 |
| camctr2 | <not required> | allow demo user to control PTZ camera on video 2 |
| camctr3 | <not required> | allow demo user to control PTZ camera on video 3 |
| camctr4 | <not required> | allow demo user to control PTZ camera on video 4 |
| view1 | <not required> | allow demo user to watch channel 1 |
| view2 | <not required> | allow demo user to watch channel 2 |
| view3 | <not required> | allow demo user to watch channel 3 |
| view4 | <not required> | allow demo user to watch channel 4 |

Homepage layout configuration URL

URL: </cgi-bin/layout.cgi>

| NAME | VALUE | DESCRIPTION |
|---------|--|-----------------------------------|
| cuslogo | blank | hide logo |
| | def | use default logo |
| | url | use image from URL |
| logourl | <text string shorter than 80 characters> | URL of image for logo |
| linkurl | <text string shorter than 80 characters> | URL to link when clicking on logo |
| cusback | blank | hide background image |
| | def | use default background |
| | url | use image from URL |
| backurl | <text string shorter than 80 characters> | URL of image for background |
| fcolor | <0 ~ 15> | color index for font |
| bcolor | <0 ~ 15> | color index for background |
| dismode | image | display homepage in image mode |
| | text | display homepage in text mode |
| str1 | <text string shorter than 40 characters> | text for channel 1 in text mode |
| str2 | <text string shorter than 40 characters> | text for channel 2 in text mode |
| str3 | <text string shorter than 40 characters> | text for channel 3 in text mode |
| str4 | <text string shorter than 40 characters> | text for channel 4 in text mode |

E. Settings of Supported PTZ Cameras

Since the COM port settings can be adjusted to other than the default settings, check the correct default settings for the attached camera.

| Camera model | Baud rate | Data bits | Stop bit | Parity bit |
|------------------|-----------|-----------|----------|------------|
| Sony VISCA | 9600 | 8 | 1 | None |
| Canon VC-C1 | 9600 | 8 | 2 | None |
| Canon VC-C3 | 9600 | 8 | 2 | None |
| Canon VC-C4 | 9600 | 8 | 1 | None |
| Pelco D protocol | 2400 | 8 | 1 | None |
| Dynacolor dome | 9600 | 8 | 1 | None |
| Ernitec | 9600 | 8 | 1 | None |
| Lilin | 9600 | 8 | 1 | None |

F. Camera Control Cable

The included cable can be used to control motorized cameras of desktop types from Sony and Canon. The pin assignment is illustrated in the following chart. To control cameras of another brand, check the user's manual of the motorized camera if the pin assignment of the control cable is appropriate.

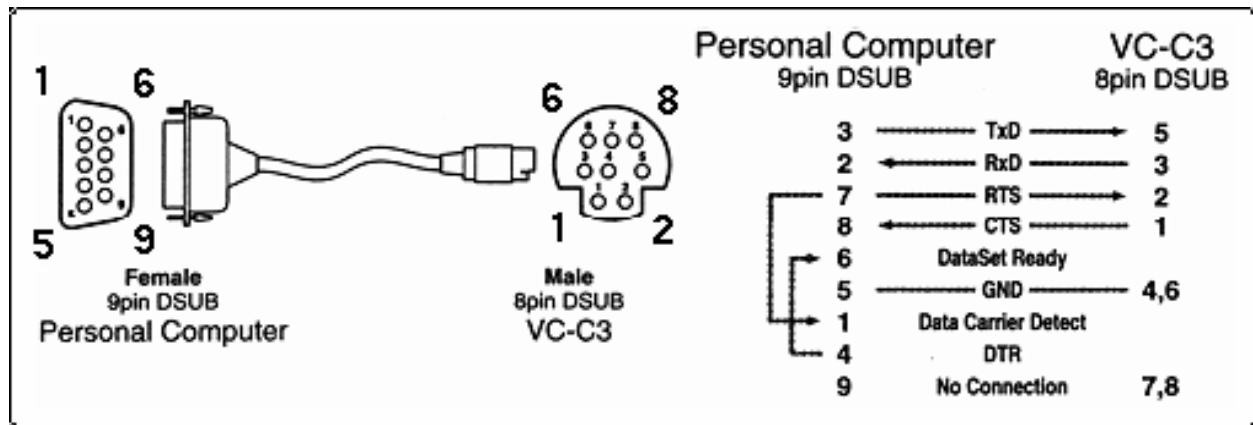

G. Time Zone Table

While setting the time zone in automatic date/time synchronization, find the hour offset in the followings for your region. GMT stands for Greenwich Mean Time, which is the global time that all time zones are measured from.

| | |
|-------------|--|
| (GMT-12:00) | International Date Line West |
| (GMT-11:00) | Midway Island, Samoa |
| (GMT-10:00) | Hawaii |
| (GMT-09:00) | Alaska |
| (GMT-08:00) | Pacific Time (US & Canada), Tijuana |
| (GMT-07:00) | Arizona |
| (GMT-07:00) | Chihuahua, La Paz, Mazatlan |
| (GMT-07:00) | Mountain Time (US & Canada) |
| (GMT-06:00) | Central America |
| (GMT-06:00) | Central Time (US & Canada) |
| (GMT-06:00) | Guadalajara, Mexico City, Monterrey |
| (GMT-06:00) | Saskatchewan |
| (GMT-05:00) | Bogota, Lima, Quito |
| (GMT-05:00) | Eastern Time (US & Canada) |
| (GMT-05:00) | Indiana (East) |
| (GMT-04:00) | Atlantic Time (Canada) |
| (GMT-04:00) | Caracas, La Paz |
| (GMT-04:00) | Santiago |
| (GMT-03:30) | Newfoundland |
| (GMT-03:00) | Brasilia |
| (GMT-03:00) | Buenos Aires, Georgetown |
| (GMT-03:00) | Greenland |
| (GMT-02:00) | Mid-Atlantic |
| (GMT-01:00) | Azores |
| (GMT-01:00) | Cape Verde Is. |
| (GMT) | Casablanca, Monrovia |
| (GMT) | Greenwich Mean Time: Dublin, Edinburgh, Lisbon, London |
| (GMT+01:00) | Amsterdam, Berlin, Bern, Stockholm, Vienna |
| (GMT+01:00) | Belgrade, Bratislava, Budapest, Ljubljana, Prague |
| (GMT+01:00) | Brussels, Copenhagen, Madrid, Paris |
| (GMT+01:00) | Sarajevo, Skopje, Warsaw, Zagreb |

| | |
|-------------|---|
| (GMT+01:00) | West Central Africa |
| (GMT+02:00) | Athens, Istanbul, Minsk |
| (GMT+02:00) | Bucharest |
| (GMT+02:00) | Cairo |
| (GMT+02:00) | Harare, Pretoria |
| (GMT+02:00) | Helsinki, Kyiv, Riga, Sofia, Tallinn, Vilnius |
| (GMT+02:00) | Jerusalem |
| (GMT+03:00) | Baghdad |
| (GMT+03:00) | Kuwait, Riyadh |
| (GMT+03:00) | Moscow, St. Petersburg, Volgograd |
| (GMT+03:00) | Nairobi |
| (GMT+03:30) | Tehran |
| (GMT+04:00) | Abu Dhabi, Muscat |
| (GMT+04:00) | Baku, Tbilisi, Yerevan |
| (GMT+04:30) | Kabul |
| (GMT+05:00) | Ekaterinburg |
| (GMT+05:00) | Islamabad, Karachi, Tashkent |
| (GMT+05:30) | Chennai, Kolkata, Mumbai, New Delhi |
| (GMT+05:45) | Kathmandu |
| (GMT+06:00) | Almaty, Novosibirsk |
| (GMT+06:00) | Astana, Dhaka |
| (GMT+06:00) | Sri Jayawardenepura |
| (GMT+06:30) | Rangoon |
| (GMT+07:00) | Bangkok, Hanoi, Jakarta |
| (GMT+07:00) | Krasnoyarsk |
| (GMT+08:00) | Beijing, Chongqing, Hongkong, Urumqi |
| (GMT+08:00) | Taipei |
| (GMT+08:00) | Irkutsk, Ulaan Bataar |
| (GMT+08:00) | Kuala Lumpur, Singapore |
| (GMT+08:00) | Perth |
| (GMT+09:00) | Osaka, Sapporo, Tokyo |
| (GMT+09:00) | Seoul |
| (GMT+09:00) | Yakutsk |
| (GMT+09:30) | Adelaide |
| (GMT+09:30) | Darwin |
| (GMT+10:00) | Brisbane |
| (GMT+10:00) | Canberra, Melbourne, Sydney |
| (GMT+10:00) | Guam, Port Moresby |

D-Link® Building Networks for People

- (GMT+10:00) Hobart
- (GMT+10:00) Vladivostok
- (GMT+11:00) Magadan, Solomon Is., New Caledonia
- (GMT+12:00) Auckland, Wellington
- (GMT+12:00) Fiji, Kamchatka, Marshall Is..
- (GMT+13:00) Nuku'alofa

H. Technical Specifications

System

CPU: Trimedia PNX1300

RAM: 16MB SDRAM

ROM: 2MB FLASH ROM

Networking

Adjustable bandwidth limit

Protocol

TCP/IP, HTTP, SMTP, FTP, Telnet, NTP, DNS and DHCP

Modem

PPP (dial-up, direct cable connection)

Physical

10BaseT Ethernet or 100BaseT Fast Ethernet

Video

Algorithm Supported

JPEG, MJPEG

Video Inputs and Outputs

4 BNC video inputs with 75 Ω terminal switch

NTSC/PAL auto-sensing

4 BNC loop-through video outputs

Features

Adjustable image size and quality

B/W or color control

Quad screen display

Timestamp and text overlay

Resolution

NTSC

Up to 30 frames at 176x112

Up to 30 frames at 352x240

Up to 9 frames at 704x480 or quad

PAL

Up to 25 frames at 176x144

Up to 25 frames at 352x288

Up to 8 frames at 704x576 or quad

Serial Port

COM1

9 pin D-SUB RS232 or RS485 (PTZ camera control) max.115.2Kbps

COM2

9 pin D-SUB RS232 (modem or PTZ camera control) max.115.2Kbps

General I/O

4 sensor inputs (max. 12VDC 50mA)

2 relay outputs (max. 24VDC 1A, 125VAC 0.5A)

LED Indicator

System power and status indicators

Network link and speed indicators

Dimension

216.7mm(L) * 193.7mm(W) * 44.3mm(H)

Weight

Net. 970g.

Power

Consumption: near 7.8W

Universal switching power supply included

Input: 100-240VAC, 50/60Hz, 0.4A

Output: 12VDC, 1.5A

External power supply

6-15VDC, min. 15W

Operating Environment

Temperature: 0-65°C/32-149°F

Humidity: 95%RH

Alarm Features

4-channel motion detection with object size and sensitivity

Daily repeat timing schedule

3 color images per camera for pre/post alarm

Automatic transfer of stored images via email or FTP with event-triggered actions

PAN/TILT/ZOOM

Multiple PTZ camera control through RS232 or RS485

Supported devices and protocols,

Sony VISCA protocol, Canon VC-C1, VC-C3,

VC-C4, Dynacolor SmartDOME, Pelco

D-protocol, Lilin Speeddome, Ernitech

Speeddome

CGI command serial driver is supported

Remote Software Upgrade

System firmware upgradeable via FTP or bundled upgrade wizard

Viewing System Requirement

Operating System

Microsoft Windows, Linux, Unix and Mac OS

Browser

Internet Explorer 4.x or above,

Netscape Navigator 4.x or above

Bundled Free Software

Surveillance software to record and replay pictures on PC hard disk

LIMITED WARRANTY

D-Link provides this limited warranty for its product only to the person or entity who originally purchased the product from D-Link or its authorized reseller or distributor.

Limited Hardware Warranty: D-Link warrants that the hardware portion of the D-Link products described below (“Hardware”) will be free from material defects in workmanship and materials from the date of original retail purchase of the Hardware, for the period set forth below applicable to the product type (“Warranty Period”) if the Hardware is used and serviced in accordance with applicable documentation; provided that a completed Registration Card is returned to an Authorized D-Link Service Office within ninety (90) days after the date of original retail purchase of the Hardware. If a completed Registration Card is not received by an authorized D-Link Service Office within such ninety (90) period, then the Warranty Period shall be ninety (90) days from the date of purchase.

| Product Type | Warranty Period |
|---|------------------|
| Product (excluding power supplies and fans) | One (1) Year |
| Power Supplies and Fans | One (1) Year |
| Spare parts and spare kits | Ninety (90) days |

D-Link’s sole obligation shall be to repair or replace the defective Hardware at no charge to the original owner. Such repair or replacement will be rendered by D-Link at an Authorized D-Link Service Office. The replacement Hardware need not be new or of an identical make, model or part; D-Link may in its discretion may replace the defective Hardware (or any part thereof) with any reconditioned product that D-Link reasonably determines is substantially equivalent (or superior) in all material respects to the defective Hardware. The Warranty Period shall extend for an additional ninety (90) days after any repaired or replaced Hardware is delivered. If a material defect is incapable of correction, or if D-Link determines in its sole discretion that it is not practical to repair or replace the defective Hardware, the price paid by the original purchaser for the defective Hardware will be refunded by D-Link upon return to D-Link of the defective Hardware. All Hardware (or part thereof) that is replaced by D-Link, or for which the purchase price is refunded, shall become the property of D-Link upon replacement or refund.

Limited Software Warranty: D-Link warrants that the software portion of the product (“Software”) will substantially conform to D-Link’s then current functional specifications for the Software, as set forth in the applicable documentation, from the date of original delivery of the Software for a period of ninety (90) days (“Warranty Period”), if the Software is properly installed on approved hardware and operated as contemplated in its documentation. D-Link further warrants that, during the Warranty Period, the magnetic media on which D-Link delivers the Software will be free of physical defects. D-Link’s sole obligation shall be to replace the non-conforming Software (or defective media) with software that substantially conforms to D-Link’s



functional specifications for the Software. Except as otherwise agreed by D-Link in writing, the replacement Software is provided only to the original licensee, and is subject to the terms and conditions of the license granted by D-Link for the Software. The Warranty Period shall extend for an additional ninety (90) days after any replacement Software is delivered. If a material non-conformance is incapable of correction, or if D-Link determines in its sole discretion that it is not practical to replace the non-conforming Software, the price paid by the original licensee for the non-conforming Software will be refunded by D-Link; provided that the non-conforming Software (and all copies thereof) is first returned to D-Link. The license granted respecting any Software for which a refund is given automatically terminates.

What You Must Do For Warranty Service:

Registration Card. The Registration Card provided at the back of this manual must be completed and returned to an Authorized D-Link Service Office for each D-Link product within ninety (90) days after the product is purchased and/or licensed. The addresses/telephone/fax list of the nearest Authorized D-Link Service Office is provided in the back of this manual. FAILURE TO PROPERLY COMPLETE AND TIMELY RETURN THE REGISTRATION CARD MAY AFFECT THE WARRANTY FOR THIS PRODUCT.

Submitting A Claim. Any claim under this limited warranty must be submitted in writing before the end of the Warranty Period to an Authorized D-Link Service Office. The claim must include a written description of the Hardware defect or Software nonconformance in sufficient detail to allow D-Link to confirm the same. The original product owner must obtain a Return Material Authorization (RMA) number from the Authorized D-Link Service Office and, if requested, provide written proof of purchase of the product (such as a copy of the dated purchase invoice for the product) before the warranty service is provided. After an RMA number is issued, the defective product must be packaged securely in the original or other suitable shipping package to ensure that it will not be damaged in transit, and the RMA number must be prominently marked on the outside of the package. The packaged product shall be insured and shipped to D-Link, 17595 Mt. Herrmann Street Fountain Valley, CA 92708 USA, with all shipping costs prepaid. D-Link may reject or return any product that is not packaged and shipped in strict compliance with the foregoing requirements, or for which an RMA number is not visible from the outside of the package. The product owner agrees to pay D-Link's reasonable handling and return shipping charges for any product that is not packaged and shipped in accordance with the foregoing requirements, or that is determined by D-Link not to be defective or non-conforming.

What Is Not Covered:

This limited warranty provided by D-Link does not cover:

Products that have been subjected to abuse, accident, alteration, modification, tampering, negligence, misuse, faulty installation, lack of reasonable care, repair or service in any way that is not contemplated in the documentation for the product, or if the model or serial number has been altered, tampered with, defaced or removed; Initial installation, installation and removal of the product for repair, and shipping costs; Operational DVS-104 User Manual v1.00

adjustments covered in the operating manual for the product, and normal maintenance; Damage that occurs in shipment, due to act of God, failures due to power surge, and cosmetic damage; and Any hardware, software, firmware or other products or services provided by anyone other than D-Link.

Disclaimer of Other Warranties:

EXCEPT FOR THE LIMITED WARRANTY SPECIFIED HEREIN, THE PRODUCT IS PROVIDED “AS-IS” WITHOUT ANY WARRANTY OF ANY KIND INCLUDING, WITHOUT LIMITATION, ANY WARRANTY OF MERCHANTABILITY, FITNESS FOR A PARTICULAR PURPOSE AND NON-INFRINGEMENT. IF ANY IMPLIED WARRANTY CANNOT BE DISCLAIMED IN ANY TERRITORY WHERE A PRODUCT IS SOLD, THE DURATION OF SUCH IMPLIED WARRANTY SHALL BE LIMITED TO NINETY (90) DAYS. EXCEPT AS EXPRESSLY COVERED UNDER THE LIMITED WARRANTY PROVIDED HEREIN, THE ENTIRE RISK AS TO THE QUALITY, SELECTION AND PERFORMANCE OF THE PRODUCT IS WITH THE PURCHASER OF THE PRODUCT.

Limitation of Liability: TO THE MAXIMUM EXTENT PERMITTED BY LAW, D-LINK IS NOT LIABLE UNDER ANY CONTRACT, NEGLIGENCE, STRICT LIABILITY OR OTHER LEGAL OR EQUITABLE THEORY FOR ANY LOSS OF USE OF THE PRODUCT, INCONVENIENCE OR DAMAGES OF ANY CHARACTER, WHETHER DIRECT, SPECIAL, INCIDENTAL OR CONSEQUENTIAL (INCLUDING, BUT NOT LIMITED TO, DAMAGES FOR LOSS OF GOODWILL, WORK STOPPAGE, COMPUTER FAILURE OR MALFUNCTION, LOSS OF INFORMATION OR DATA CONTAINED IN, STORED ON, OR INTEGRATED WITH ANY PRODUCT RETURNED TO D-LINK FOR WARRANTY SERVICE) RESULTING FROM THE USE OF THE PRODUCT, RELATING TO WARRANTY SERVICE, OR ARISING OUT OF ANY BREACH OF THIS LIMITED WARRANTY, EVEN IF D-LINK HAS BEEN ADVISED OF THE POSSIBILITY OF SUCH DAMAGES. THE SOLE REMEDY FOR A BREACH OF THE FOREGOING LIMITED WARRANTY IS REPAIR, REPLACEMENT OR REFUND OF THE DEFECTIVE OR NON-CONFORMING PRODUCT.

GOVERNING LAW: This Limited Warranty shall be governed by the laws of the state of California. Some states do not allow exclusion or limitation of incidental or consequential damages, or limitations on how long an implied warranty lasts, so the foregoing limitations and exclusions may not apply. This limited warranty provides specific legal rights and the product owner may also have other rights which vary from state to state.

Wichtige Sicherheitshinweise

1. Bitte lesen Sie sich diese Hinweise sorgfältig durch.
2. Heben Sie diese Anleitung für den spätern Gebrauch auf.
3. Vor jedem Reinigen ist das Gerät vom Stromnetz zu trennen. Vervenden Sie keine Flüssig- oder Aerosolreiniger. Am besten dient ein angefeuchtetes Tuch zur Reinigung.
4. Um eine Beschädigung des Gerätes zu vermeiden sollten Sie nur Zubehörteile verwenden, die vom DVS-104 User Manual v1.00

Hersteller zugelassen sind.

5. Das Gerät ist vor Feuchtigkeit zu schützen.
6. Bei der Aufstellung des Gerätes ist auf sicheren Stand zu achten. Ein Kippen oder Fallen könnte Verletzungen hervorrufen. Verwenden Sie nur sichere Standorte und beachten Sie die Aufstellhinweise des Herstellers.
7. Die Belüftungsöffnungen dienen zur Luftzirkulation die das Gerät vor Überhitzung schützt. Sorgen Sie dafür, daß diese Öffnungen nicht abgedeckt werden.
8. Beachten Sie beim Anschluß an das Stromnetz die Anschlußwerte.
9. Die Netzanschlußsteckdose muß aus Gründen der elektrischen Sicherheit einen Schutzleiterkontakt haben.
10. Verlegen Sie die Netzanschlußleitung so, daß niemand darüber fallen kann. Es sollte auch nichts auf der Leitung abgestellt werden.
11. Alle Hinweise und Warnungen die sich an den Geräten befinden sind zu beachten.
12. Wird das Gerät über einen längeren Zeitraum nicht benutzt, sollten Sie es vom Stromnetz trennen. Somit wird im Falle einer Überspannung eine Beschädigung vermieden.
13. Durch die Lüftungsöffnungen dürfen niemals Gegenstände oder Flüssigkeiten in das Gerät gelangen. Dies könnte einen Brand bzw. Elektrischen Schlag auslösen.
14. Öffnen Sie niemals das Gerät. Das Gerät darf aus Gründen der elektrischen Sicherheit nur von autorisiertem Servicepersonal geöffnet werden.
15. Wenn folgende Situationen auftreten ist das Gerät vom Stromnetz zu trennen und von einer qualifizierten Servicestelle zu überprüfen:
 - a – Netzkabel oder Netzstecker sind beschädigt.
 - b – Flüssigkeit ist in das Gerät eingedrungen.
 - c – Das Gerät war Feuchtigkeit ausgesetzt.
 - d – Wenn das Gerät nicht der Bedienungsanleitung entsprechend funktioniert oder Sie mit Hilfe dieser Anleitung keine Verbesserung erzielen.
 - e – Das Gerät ist gefallen und/oder das Gehäuse ist beschädigt.
 - f – Wenn das Gerät deutliche Anzeichen eines Defektes aufweist.
16. Bei Reparaturen dürfen nur Originalersatzteile bzw. den Originalteilen entsprechende Teile verwendet werden. Der Einsatz von ungeeigneten Ersatzteilen kann eine weitere Beschädigung hervorrufen.
17. Wenden Sie sich mit allen Fragen die Service und Reparatur betreffen an Ihren Servicepartner. Somit stellen Sie die Betriebssicherheit des Gerätes sicher.
18. Zum Netzanschluß dieses Gerätes ist eine geprüfte Leitung zu verwenden, Für einen Nennstrom bis 6A und einem Gerätegewicht größer 3kg ist eine Leitung nicht leichter als H05VV-F, 3G, 0.75mm² einzusetzen.

Trademarks

Copyright © 2004 D-Link Corporation. Contents subject to change without prior notice. D-Link is a registered trademark of D-Link Corporation. DVS-104 User Manual v1.00



trademark of D-Link Corporation/D-Link Systems, Inc. All other trademarks belong to their respective proprietors.

Copyright Statement

No part of this publication may be reproduced in any form or by any means or used to make any derivative such as translation, transformation, or adaptation without permission from D-Link Corporation/D-Link Systems Inc., as stipulated by the United States Copyright Act of 1976.

CE Mark Warning

This is a Class B product. In a domestic environment, this product may cause radio interference, in which case the user may be required to take adequate measures

Warnung!

Dies ist in Produkt der Klasse A. Im Wohnbereich kann dieses Produkt Funkstoerungen verursachen. In diesem Fall kann vom Benutzer verlangt werden, angemessene Massnahmen zu ergreifen.

Advertencia de Marca de la CE

Este es un producto de Clase A. En un entorno doméstico, puede causar interferencias de radio, en cuyo case, puede requerirse al usuario para que adopte las medidas adecuadas.

Attention!

Ceci est un produit de classe A. Dans un environnement domestique, ce produit pourrait causer des interférences radio, auquel cas l'utilisateur devrait prendre les mesures adéquates.

Attenzione!

Il presente prodotto appartiene alla classe A. Se utilizzato in ambiente domestico il prodotto può causare interferenze radio, nel cui caso è possibile che l'utente debba assumere provvedimenti adeguati.

FCC Warning

This equipment has been tested and found to comply with the limits for a Class A digital device, pursuant to part 15 of the FCC Rules. These limits are designed to provide reasonable protection against harmful interference in a residential installation. This equipment generates, uses and can radiate radio frequency energy and, if not installed and used in accordance with the instructions, may cause harmful interference

DVS-104 User Manual v1.00

to radio communications. However, there is no guarantee that interference will not occur in a particular installation. If this equipment does cause harmful interference to radio or television reception, which can be determined by turning the equipment off and on, the user is encouraged to try to correct the interference by one or more of the following measures:

- Reorient or relocate the receiving antenna.
- Increase the separation between the equipment and receiver.
- Connect the equipment into an outlet on a circuit different from that to which the receiver is connected.
- Consult the dealer or an experienced radio/ TV technician for help.

D-Link® Offices

| | |
|------------------|---|
| AUSTRALIA | D-LINK AUSTRALIA
1 Giffnock Ave, North Ryde, NSW 2113, Australia
TEL: 61-2-8899-1800 FAX: 61-2-8899-1868
TOLL FREE: 1800-177-100 (Australia), 0800-900900 (New Zealand)
E-MAIL: support@dlink.com.au, info@dlink.com.au URL: www.dlink.com.au |
| BENELUX | D-LINK BENELUX
Fellenoord 130, 5611 ZB Eindhoven, The Netherlands
TEL: 31-40-2668713 FAX: 31-40-2668666
E-MAIL: info@dlink-benelux.nl, info@dlink-benelux.be URL: www.dlink-benelux.nl/, www.dlink-benelux.be/ |
| CANADA | D-LINK CANADA
#2180 Winston Park Drive, Oakville, Ontario, L6H 5W1 Canada
TEL: 1-905-829-5033 FAX: 1-905-829-5095 FREE CALL: 1-800-354-6522
E-MAIL: techsup@dlink.ca URL: www.dlink.ca FTP: ftp.dlinknet.com |
| CHILE | D-LINK SOUTH AMERICA
Isidora Goyechea 2934 of 702, Las Condes, Santiago – Chile S.A.
TEL: 56-2-232-3185 FAX: 56-2-232-0923
E-MAIL: ccasassu@dlink.cl, tsilva@dlink.cl URL: www.dlink.cl |
| CHINA | D-LINK CHINA
2F., Sigma Building, 49 Zhichun Road, Haidian District, 100080 Beijing, China
TEL: 86-10-85182533 FAX: 86-10-85182250 |
| DENMARK | D-LINK DENMARK
Naverland 2, DK-2600 Glostrup, Copenhagen, Denmark
TEL: 45-43-969040 FAX: 45-43-424347
E-MAIL: info@dlink.dk URL: www.dlink.dk |
| EGYPT | D-LINK MIDDLE EAST
7 Assem Ebn Sabet Street, Heliopolis Cairo, Egypt
TEL: 202-2456176 FAX: 202-2456192
E-MAIL: support@dlink-me.com URL: www.dlink-me.com |
| FINLAND | D-Link FINLAND
Thlli-ja Pakkahuone Katanokanlaituri 5, FIN-00160 Helsinki, Finland
TEL: 358-9-622-91660 FAX: 358-9-622-91661
E-MAIL: info@dlink-fi.com URL: www.dlink-fi.com |
| FRANCE | D-LINK FRANCE
Le Florilege #2, Allee de la Fresnerie, 78330 Fontenay le Fleury France
TEL: 33-1-302-38688 FAX: 33-1-3023-8689
E-MAIL: info@dlink-france.fr URL: www.dlink-france.fr |
| GERMANY | D-LINK Central Europe/D-Link Deutschland GmbH
Schwalbacher Strasse 74, D-65760 Eschborn, Germany
TEL: 49-6196-77990 FAX: 49-6196-7799300
INFO LINE: 00800-7250-0000 (toll free) HELP LINE: 00800-7250-4000 (toll free)
REPAIR LINE: 00800-7250-8000
E-MAIL: info@dlink.de URL: www.dlink.de |
| IBERIA | D-LINK IBERIA
Gran Via de Carlos III, 84, 3º Edificio Trade, 08028 BARCELONA
TEL: 34 93 4090770 FAX 34 93 4910795
E-MAIL: info@dlinkiberia.es URL: www.dlinkiberia.es |
| INDIA | D-LINK INDIA
Plot No.5, Kuria-Bandra Complex Road, Off Cst Road, Santacruz (E), Bombay - 400 098 India
TEL: 91-22-652-6696 FAX: 91-22-652-8914
E-MAIL: service@dlink.india.com URL: www.dlink-india.com |
| ITALY | D-LINK ITALIA
Via Nino Bonnet No. 6/b, 20154 Milano, Italy
TEL: 39-02-2900-0676 FAX: 39-02-2900-1723
E-MAIL: info@dlink.it URL: www.dlink.it |
| JAPAN | D-LINK JAPAN
10F, 8-8-15 Nishi-Gotanda, Shinagawa-ku, Tokyo 141, Japan
TEL: 81-3-5434-9678 FAX: 81-3-5434-9868
E-MAIL: kida@d-link.co.jp URL: www.d-link.co.jp |
| NORWAY | D-LINK NORWAY
Waldemar Thranesgt. 77, 0175 Oslo, Norway
TEL: 47-22-991890 FAX: 47-22-207039 |
| RUSSIA | D-LINK RUSSIA 129626 Russia, Graphskiy per., 14
Tel /fax +7 (095) 744-00-99
mailto:mail@dlink.ru , Web: www.dlink.ru |
| SINGAPORE | D-LINK INTERNATIONAL
1 International Business Park, #03-12 The Synergy, Singapore 609917
TEL: 65-774-6233 FAX: 65-774-6322
E-MAIL: info@dlink.com.sg URL: www.dlink-intl.com |
| S. AFRICA | D-LINK SOUTH AFRICA
102-106 Witchhazel Avenue, Einetein Park 2, Block B, Highveld Technopark Centurion, South Africa
TEL: 27(0)126652165 FAX: 27(0)126652186
E-MAIL: attie@d-link.co.za URL: www.d-link.co.za |
| SWEDEN | D-LINK SWEDEN
P.O. Box 15036, S-167 15 Bromma Sweden
TEL: 46-(0)8564-61900 FAX: 46-(0)8564-61901
E-MAIL: info@dlink.se URL: www.dlink.se |
| TAIWAN | D-LINK TAIWAN
2F, No. 119 Pao-Chung Road, Hsin-Tien, Taipei, Taiwan,
TEL: 886-2-2910-2626 FAX: 886-2-2910-1515
E-MAIL: dssqa@tsc.dlinktw.com.tw URL: www.dlinktw.com.tw |
| U.K. | D-LINK EUROPE
4th Floor, Merit House, Edgware Road, Colindale, London, NW9 5AB, U.K. |

D-Link[®] Building Networks for People

TEL: 44-20-8731-5555 FAX: 44-20-8731-5511
E-MAIL: info@dlink.co.uk URL: www.dlink.co.uk

U.S.A.

D-LINK U.S.A.
17595 Mt. Herrmann Street
Fountain Valley, CA 92708 USA
TEL: 1-714-885-6000 FAX: 1-866-743-4905 INFO LINE: 1-877-453-5465
E-MAIL: tech@dlink.com, support@dlink.com URL: www.dlink.com



Building Networks for People

Registration Card

Print, type or use block letters.

Your name: Mr./Ms. _____
 Organization: _____ Dept. _____
 Your title at organization: _____
 Telephone: _____ Fax: _____
 Organization's full address: _____

 Country: _____
 Date of purchase (Month/Day/Year): _____

| Product Model | Product Serial No. | * Product installed in type of computer (e.g., Compaq 486) | * Product installed in computer serial No. |
|---------------|--------------------|--|--|
| | | | |
| | | | |
| | | | |
| | | | |
| | | | |

(* Applies to adapters only)

Product was purchased from:

Reseller's name: _____
 Telephone: _____ Fax: _____
 Reseller's full address: _____

Answers to the following questions help us to support your product:

1. Where and how will the product primarily be used?

Home Office Travel Company Business Home Business Personal Use

2. How many employees work at installation site?

1 employee 2-9 10-49 50-99 100-499 500-999 1000 or more

3. What network protocol(s) does your organization use ?

XNS/IPX TCP/IP DECnet Others _____

4. What network operating system(s) does your organization use ?

D-Link LANsmart Novell NetWare NetWare Lite SCO Unix/Xenix PC NFS 3Com 3+Open
Banyan Vines DECnet Pathwork Windows NT Windows NTAS Windows '95
Others _____

5. What network management program does your organization use ?

D-View HP OpenView/Windows HP OpenView/Unix SunNet Manager Novell NMS
NetView 6000 Others _____

6. What network medium/media does your organization use ?

Fiber-optics Thick coax Ethernet Thin coax Ethernet 10BASE-T UTP/STP
100BASE-TX 100BASE-T4 100VGAnyLAN Others _____

7. What applications are used on your network?

Desktop publishing Spreadsheet Word processing CAD/CAM
Database management Accounting Others _____

8. What category best describes your company?

Aerospace Engineering Education Finance Hospital Legal Insurance/Real Estate Manufacturing
Retail/Chainstore/Wholesale Government Transportation/Utilities/Communication VAR
System house/company Other _____

9. Would you recommend your D-Link product to a friend?

Yes No Don't know yet

10. Your comments on this product?

**PLEASE
PLACE STAMP
HERE**

TO:

D-Link[®]



