



X S T A C K[®]

Hardware Installation Guide

Product Model: **xStack**[®] DES-3528/DES-3552 Series
Layer 2 Managed Stackable Fast Ethernet Switch
Release 3.01



Information in this document is subject to change without notice.

© 2013 D-Link Corporation. All rights reserved.

Reproduction of this document in any manner whatsoever without the written permission of D-Link Corporation is strictly forbidden.

Trademarks used in this text: D-Link and the D-LINK logo are trademarks of D-Link Corporation; Microsoft and Windows are registered trademarks of Microsoft Corporation.

Other trademarks and trade names may be used in this document to refer to either the entities claiming the marks and names or their products.

D-Link Corporation disclaims any proprietary interest in trademarks and trade names other than its own.

January, 2013 P/N 651ES3500095G

FCC Warning

This equipment has been tested and found to comply with the limits for a Class A digital device, pursuant to Part 15 of the FCC Rules. These limits are designed to provide reasonable protection against harmful interference when the equipment is operated in a commercial environment. This equipment generates, uses, and can radiate radio frequency energy and, if not installed and used in accordance with this manual, may cause harmful interference to radio communications. Operation of this equipment in a residential area is likely to cause harmful interference in which case the user will be required to correct the interference at their expense.

CE Mark Warning

This is a Class A product. In a domestic environment, this product may cause radio interference in which case the user may be required to take adequate measures.

Warnung!

Dies ist ein Produkt der Klasse A. Im Wohnbereich kann dieses Produkt Funkstörungen verursachen. In diesem Fall kann vom Benutzer verlangt werden, angemessene Massnahmen zu ergreifen.

Precaución!

Este es un producto de Clase A. En un entorno doméstico, puede causar interferencias de radio, en cuyo caso, puede requerirse al usuario para que adopte las medidas adecuadas.

Attention!

Ceci est un produit de classe A. Dans un environnement domestique, ce produit pourrait causer des interférences radio, auquel cas l'utilisateur devrait prendre les mesures adéquates.

Attenzione!

Il presente prodotto appartiene alla classe A. Se utilizzato in ambiente domestico il prodotto può causare interferenze radio, nel cui caso è possibile che l'utente debba assumere provvedimenti adeguati.

VCCI Warning

この装置は、クラス A 情報技術装置です。この装置を家庭環境で使用すると電波妨害を引き起こすことがあります。この場合には使用者が適切な対策を講ずるよう要求されることがあります。 VCCI-A

Table of Contents

Intended Readers	v
Typographical Conventions	v
Notes, Notices, and Cautions	v
Safety Instructions	vi
Safety Cautions	vi
General Precautions for Rack-Mountable Products	vii
Protecting Against Electrostatic Discharge	vii
Introduction	9
Gigabit Ethernet Technology	9
Switch Description	9
Features	10
Ports	11
Front-Panel Components	12
LED Indicators	14
Rear Panel Description	17
Side Panel Description	19
Gigabit Combo Ports	20
Installation	21
Package Contents	21
Before You Connect to the Network	21
Installing the Switch without the Rack	22
Installing the Switch in a Rack	22
Mounting the Switch in a Standard 19" Rack	23
Power On (AC Power)	24
Power Failure (AC Power)	24
Connecting DC Power to the DES-3528DC	24
Connecting the Switch	25
Switch to End Node	25
Switch to Hub or Switch	25
Connecting To Network Backbone or Server	26
Introduction to Switch Management	27
Management Options	27
Web-based Management Interface	27
SNMP-based Management	27
Connecting the Console Port (RS-232 DCE)	27
First Time Connecting to the Switch	28
Password Protection	29
SNMP Settings	30
Traps	31
MIBs	31
IP Address Assignment	31
Web-based Switch Configuration	33
Introduction	33
Login to Web Manager	33
Web-based User Interface	33
Areas of the User Interface	34
Web Pages	34
Appendix A - Technical Specifications	37

Appendix B - Cable Lengths	43
Warranties & Tech Support Information	44

Intended Readers

The **DES-3528/DES-3552 Switch Series Hardware Installation Guide** contains information for setup and management of the Switch. This manual is intended for network managers familiar with network management concepts and terminology.

Typographical Conventions

Convention	Description
[]	In a command line, square brackets indicate an optional entry. For example: [copy filename] means that optionally you can type copy followed by the name of the file. Do not type the brackets.
Bold font	Indicates a button, a toolbar icon, menu, or menu item. For example: Open the File menu and choose Cancel . Used for emphasis. May also indicate system messages or prompts appearing on your screen. For example: You have mail. Bold font is also used to represent filenames, program names and commands. For example: use the copy command.
Boldface Typewriter Font	Indicates commands and responses to prompts that must be typed exactly as printed in the manual.
Initial capital letter	Indicates a window name. Names of keys on the keyboard have initial capitals. For example: Click Enter.
<i>Italics</i>	Indicates a window name or a field. Also can indicate a variables or parameter that is replaced with an appropriate word or string. For example: type filename means that you should type the actual filename instead of the word shown in italic.
Menu Name > Menu Option	Menu Name > Menu Option Indicates the menu structure. Device > Port > Port Properties means the Port Properties menu option under the Port menu option that is located under the Device menu.

Notes, Notices, and Cautions



A **NOTE** indicates important information that helps you make better use of your device.



A **NOTICE** indicates either potential damage to hardware or loss of data and tells you how to avoid the problem.



A **CAUTION** indicates a potential for property damage, personal injury, or death.

Safety Instructions

Use the following safety guidelines to ensure your own personal safety and to help protect your system from potential damage. Throughout this document, the caution icon () is used to indicate cautions and precautions that you need to review and follow.

Safety Cautions

To reduce the risk of bodily injury, electrical shock, fire and damage to the equipment, observe the following precautions.

- Observe and follow service markings. Do not service any product except as explained in your system documentation. Opening or removing covers that are marked with the triangular symbol with a lightning bolt may expose you to electrical shock. Only a trained service technician should service components inside these compartments.
- If any of the following conditions occur, unplug the product from the electrical outlet and replace the part or contact your trained service provider:
 - The power cable, extension cable, or plug is damaged.
 - An object has fallen into the product.
 - The product has been exposed to water.
 - The product has been dropped or damaged.
 - The product does not operate correctly when you follow the operating instructions.
- Keep your system away from radiators and heat sources. Also, do not block cooling vents.
- Do not spill food or liquids on your system components, and never operate the product in a wet environment. If the system gets wet, see the appropriate section in your troubleshooting guide or contact your trained service provider.
- Do not push any objects into the openings of your system. Doing so can cause fire or electric shock by shorting out interior components.
- Use the product only with approved equipment.
- Allow the product to cool before removing covers or touching internal components.
- Operate the product only from the type of external power source indicated on the electrical ratings label. If you are not sure of the type of power source required, consult your service provider or local power company.
- To help avoid damaging your system, be sure the voltage on the power supply is set to match the power available at your location:
 - 115 volts (V)/60 hertz (Hz) in most of North and South America and some Far Eastern countries
 - 100 V/50 Hz in eastern Japan and 100 V/60 Hz in western Japan
 - 230 V/50 Hz in most of Europe, the Middle East, and the Far East
 - 48VDC for DES-3528DC
- Also, be sure that attached devices are electrically rated to operate with the power available in your location.
- Use only approved power cable(s). If you have not been provided with a power cable for your system or for any AC-powered option intended for your system, purchase a power cable that is approved for use in your country. The power cable must be rated for the product and for the voltage and current marked on the product's electrical ratings label. The voltage and current rating of the cable should be greater than the ratings marked on the product.
- To help prevent electric shock, plug the system and peripheral power cables into properly grounded electrical outlets. These cables are equipped with three-prong plugs to help ensure proper grounding. Do not use adapter plugs or remove the grounding prong from a cable. If you must use an extension cable, use a 3-wire cable with properly grounded plugs.
- Observe extension cable and power strip ratings. Make sure that the total ampere rating of all products plugged into the extension cable or power strip does not exceed 80 percent of the ampere ratings limit for the extension cable or power strip.
- To help protect your system from sudden, transient increases and decreases in electrical power, use a surge suppressor, line conditioner, or uninterruptible power supply (UPS).

- Position system cables and power cables carefully; route cables so that they cannot be stepped on or tripped over. Be sure that nothing rests on any cables.
- Do not modify power cables or plugs. Consult a licensed electrician or your power company for site modifications. Always follow your local/national wiring rules.
- When connecting or disconnecting power to hot-pluggable power supplies, if offered with your system, observe the following guidelines:
 - Install the power supply before connecting the power cable to the power supply.
 - Unplug the power cable before removing the power supply.
 - If the system has multiple sources of power, disconnect power from the system by unplugging all power cables from the power supplies.
- Move products with care; ensure that all casters and/or stabilizers are firmly connected to the system. Avoid sudden stops and uneven surfaces.

General Precautions for Rack-Mountable Products

Observe the following precautions for rack stability and safety. Also, refer to the rack installation documentation accompanying the system and the rack for specific caution statements and procedures.

- Systems are considered to be components in a rack. Thus, "component" refers to any system as well as to various peripherals or supporting hardware.
- Before working on the rack, make sure that the stabilizers are secured to the rack, extended to the floor, and that the full weight of the rack rests on the floor. Install front and side stabilizers on a single rack or front stabilizers for joined multiple racks before working on the rack.
- Always load the rack from the bottom up, and load the heaviest item in the rack first.
- Make sure that the rack is level and stable before extending a component from the rack.
- Use caution when pressing the component rail release latches and sliding a component into or out of a rack; the slide rails can pinch your fingers.
- After a component is inserted into the rack, carefully extend the rail into a locking position, and then slide the component into the rack.
- Do not overload the AC supply branch circuit that provides power to the rack. The total rack load should not exceed 80 percent of the branch circuit rating.
- Ensure that proper airflow is provided to components in the rack.
- Do not step on or stand on any component when servicing other components in a rack.



NOTE: A qualified electrician must perform all connections to DC power and to safety grounds. All electrical wiring must comply with applicable local, regional or national codes and practices.



CAUTION: Never defeat the ground conductor or operate the equipment in the absence of a suitably installed ground conductor. Contact the appropriate electrical inspection authority or an electrician if you are uncertain that suitable grounding is available.



CAUTION: The system chassis must be positively grounded to the rack cabinet frame. Do not attempt to connect power to the system until grounding cables are connected. A qualified electrical inspector must inspect completed power and safety ground wiring. An energy hazard will exist if the safety ground cable is omitted or disconnected.

Protecting Against Electrostatic Discharge

Static electricity can harm delicate components inside your system. To prevent static damage, discharge static electricity from your body before you touch any of the electronic components, such as the microprocessor. You can do so by periodically touching an unpainted metal surface on the chassis.

You can also take the following steps to prevent damage from electrostatic discharge (ESD):

- When unpacking a static-sensitive component from its shipping carton, do not remove the component from the antistatic packing material until you are ready to install the component in your system. Just before unwrapping the antistatic packaging, be sure to discharge static electricity from your body.
- When transporting a sensitive component, first place it in an antistatic container or packaging.
- Handle all sensitive components in a static-safe area. If possible, use antistatic floor pads, workbench pads and an antistatic grounding strap.

Introduction

Gigabit Ethernet Technology

Switch Description

Features

Ports

Front-Panel Components

LED Indicators

Rear Panel Description

Side Panel Description

Gigabit Combo Ports

The DES-3528/DES-3552 Series are Layer 2 Fast Ethernet switches and members of the D-Link xStack® family. Ranging from 10/100Mbps edge switches to core gigabit switches, the xStack® switch family has been future-proof designed to provide a stacking architecture with fault tolerance, flexibility, port density, robust security and maximum throughput with a user-friendly management interface for the networking professional.

The following manual describes the installation, maintenance and configurations concerning the xStack® DES-3528, DES-3528DC, DES-3528P, DES-3552 and DES-3552P switches. Please take note that if this device was purchased outside of Europe, certain cosmetic differences between the actual switch and images in this document will be apparent to the reader, such as the faceplate and the manual cover. The DES-3528/DES-3552 Series has already joined the xStack® family for the European market and is soon to be xStack® converted, universally. Changes are made to the appearance of the device only and no configuration or internal hardware alterations occur.



NOTE: For the remainder of this manual, all versions of the DES-3528, DES-3528P, DES-3528DC, DES-3552 and DES-3552P switches will be referred to as simply the Switch or the DES-3528.

Gigabit Ethernet Technology

Gigabit Ethernet is an extension of IEEE 802.3 Ethernet utilizing the same packet structure, format, and support for full duplex, flow control, and management objects, but with a tenfold increase in theoretical throughput over 100Mbps Fast Ethernet and a one hundred-fold increase over 10Mbps Ethernet. Since it is compatible with all 10Mbps and 100Mbps Ethernet environments, Gigabit Ethernet provides a straightforward upgrade without wasting a company's existing investment in hardware, software, and trained personnel.

The increased speed and extra bandwidth offered by Gigabit Ethernet are essential to coping with the network bottlenecks that frequently develop as computers and their busses get faster and more users using applications that generate more traffic. Upgrading key components, such as your backbone and servers to Gigabit Ethernet can greatly improve network response times as well as significantly speed up the traffic between your sub networks.

Gigabit Ethernet enables fast optical fiber connections to support video conferencing, complex imaging, and similar data-intensive applications. Likewise, since data transfers occur 10 times faster than Fast Ethernet, servers outfitted with Gigabit Ethernet NIC's are able to perform 10 times the number of operations in the same amount of time.

In addition, the phenomenal bandwidth delivered by Gigabit Ethernet is the most cost-effective method to take advantage of today and tomorrow's rapidly improving switching and routing internetworking technologies.

Switch Description

The DES-3528/DES-3552 Switch Series is equipped with unshielded twisted-pair (UTP) cable ports providing dedicated 10 or 100 Mbps bandwidth. The Switch has 24/48 UTP ports and Auto MDI-X/MDI-II convertible ports that can be used for uplinking to another switch. These ports can be used for connecting PCs, printers, servers, hubs, routers, switches and other networking devices. The dual speed ports use standard twisted-pair cabling and are ideal

for segmenting networks into small, connected sub networks for superior performance. Each 10/100 port can support up to 200 Mbps of throughput in full-duplex mode.

In addition, the Switch has 2 SFP combo ports. These two-gigabit combo ports are ideal for connecting to a server or network backbone. This stackable Switch enables the network to use some of the most demanding multimedia and imaging applications concurrently with other user applications without creating bottlenecks. The built-in console interface can be used to configure the Switch's settings for priority queuing, VLANs, and port trunk groups, port monitoring, and port speed.

Features

- IEEE 802.3 10BASE-T compliant
- IEEE 802.3u 100BASE-TX compliant
- IEEE 802.1p Priority Queues
- IEEE 802.3x flow control in full duplex mode
- IEEE 802.3ad Link Aggregation Control Protocol support.
- IEEE 802.1X Port-based and MAC-based Access Control
- IEEE 802.1Q VLAN
- IEEE 802.1D Spanning Tree, IEEE 802.1W Rapid Spanning Tree and IEEE 802.1s Multiple Spanning Tree support
- Access Control List (ACL) support
- Single IP Management support
- Access Authentication Control utilizing TACACS, XTACACS and TACACS+
- Dual Image Firmware
- Simple Network Time Protocol support
- MAC Notification support
- Asymmetric VLAN support
- System and Port Utilization support
- System Log Support
- Support port-based enable and disable
- Address table: Supports up to 16K MAC addresses per device
- Supports a packet buffer of up to 1 Mbyte
- Supports Port-based VLAN Groups
- Port Trunking with flexible load distribution and fail-over function
- IGMP Snooping support
- SNMP support
- Secure Sockets Layer (SSL) and Secure Shell (SSH) support
- Port Mirroring support
- MIB support for:
 - RFC1213 MIB II
 - RFC1493 Bridge
 - RFC1907 SNMPv2 MIB
 - RFC1757, 2819 RMON
 - RFC2021 RMONv2
 - RFC1643, 2358, 2665 Ether-like MIB
 - RFC2233, 2863 Interface MIB
 - Private MIB
 - RFC2674 for 802.1p
 - RFC2618 RADIUS Authentication Client
 - RFC2620 RADIUS Accounting Client
 - RFC2925 Ping & Traceroute
 - IEEE 802.1X MIB
 - RS-232 DCE console port for Switch management
- Provides parallel LED display for port status such as link/act, speed, etc.
- High performance switching engine performs forwarding and filtering at full wire speed, maximum 14, 881 packets/sec on each 10Mbps Ethernet port, and maximum 148,810 packet/sec on 100Mbps Fast Ethernet port.
- Full- and half-duplex for both 10Mbps and 100Mbps connections. Full duplex allows the switch port to simultaneously transmit and receive data. It only works with connections to full-duplex-capable end stations and switches. Connections to a hub must take place at half-duplex
- Support broadcast storm filteringF
- Non-blocking store and forward switching scheme capability to support rate adaptation and protocol conversion
- Supports by-port Egress/Ingress rate control.
- Supports IP-MAC Port Binding.
- Efficient self-learning and address recognition mechanism enables forwarding rate at wire speed
- Supports STP Loopback Detection
- Safeguard Engine Support

Ports

The following table lists the relative ports that are present within each switch:

Device Features	DES-3528	DES-3528DC	DES-3528P	DES-3552	DES-3552P
10/100BASE-T Ports	24 Ports	24 Ports	24 Ports	48 Ports	48 Ports
PoE Function Alternative A	N/A	N/A	24 Ports	N/A	48 Ports
1000Base-T/SFP Combo Ports	2 Ports	2 Ports	2 Ports	2 Ports	2 Ports
1000Base-T Ports	2 Ports	2 Ports	2 Ports	2 Ports	2 Ports
DCE RS-232 DB-9 Console Port	One Female	One Female	One Female	One Female	One Female

The following table lists the features and compatibility for each type of port present in the DES-3528/DES-3528DC/DES-3528P/DES-3552/DES-3552P.

10/100 BASE-T	SFP Modules	1000 BASE-T
IEEE 802.3 compliant IEEE 802.3u compliant IEEE 802.3x flow control support in full-duplex IEEE 802.3af compliant (DES-3528P/DES-3552P only) Auto MDI-X/MDI-II cross over support	SFP Transceivers Supported: DEM-310GT (1000BASE-LX) DEM-311GT (1000BASE-SX) DEM-314GT (1000BASE-LHX) DEM-315GT (1000BASE-ZX) DEM-312GT2 (1000BASE-SX) DEM-210 (Single Mode 100BASE-FX) DEM-211 (Multi Mode 100BASE-FX) WDM Transceiver Supported: DEM-330T (TX-1550/RX-1310nm), up to 10km, Single-Mode DEM-330R (TX-1310/RX-1550nm), up to 10km, Single-Mode DEM-331T (TX-1550/RX-1310nm), up to 40km, Single-Mode DEM-331R (TX-1310/RX-1550nm), up to 40km, Single-Mode Compliant to the following standards: IEEE 802.3z compliance IEEE 802.3u compliance	IEEE 802.3 compliant IEEE 802.3u compliant IEEE 802.3ab compliant IEEE 802.3z compliant IEEE 802.3x flow control support in full-duplex



NOTE: The SFP combo ports on the Switch cannot be used simultaneously with the corresponding 1000BASE-T ports. If both ports are in use at the same time (ex. port 25 of the SFP and port 25 of the 1000BASE-T), the SFP ports will take priority over the combo ports and render the 1000BASE-T ports inoperable.



NOTE: For customers interested in D-View, D-Link Corporation's proprietary SNMP management software, go to the D-Link Website (www.dlink.com) and download the software and manual.

Front-Panel Components

DES-3528

- Twenty-four 10/100Mbps BASE-T ports
- Two Combo 1000BASE-T/SFP ports located to the right
- Two 1000BASE-T ports located to the rear
- One female DCE RS-232 DB-9 console port
- LEDs for Power, Console, RPS, Master, Link/Act/Speed for each port

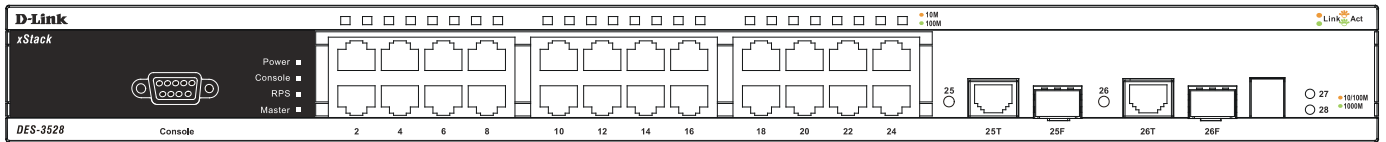

Figure 1- 1. Front Panel View of the DES-3528 switch

DES-3528P

1. Twenty-four 10/100Mbps BASE-T ports
2. Two Combo 1000BASE-T/SFP ports located to the right
3. Two 1000BASE-T ports located to the rear
4. One female DCE RS -232 DB-9 console port
5. One PoE Select Button
6. LEDs for Power, Console, RPS, MS, Link, PoE, Link/Act/Speed for each port

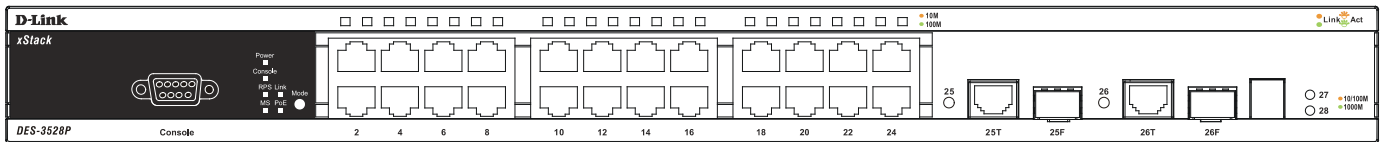

Figure 1- 2. Front Panel View of the DES-3528P switch

DES-3528DC

- Twenty-four 10/100Mbps BASE-T ports
- Two Combo 1000BASE-T/SFP ports located to the right
- Two 1000BASE-T ports located to the rear
- One female DCE RS-232 DB-9 console port
- LEDs for Power, Console, Master, Link/Act/Speed for each port

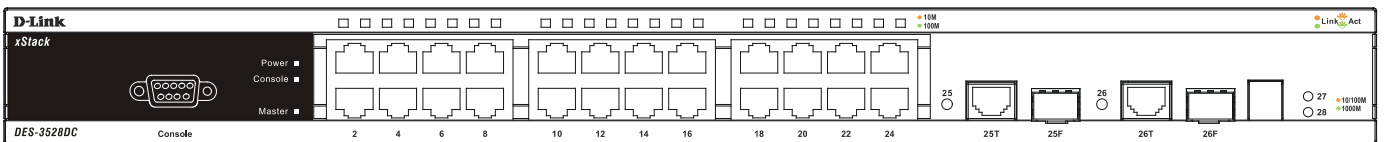

Figure 1- 3. Front Panel View of the DES-3528DC switch

DES-3552

- Forty-eight 10/100Mbps BASE-T ports
- Two Combo 1000BASE-T/SFP ports located to the right
- Two 1000BASE-T ports located to the rear
- One female DCE RS -232 DB-9 console port
- LEDs for Power, Console, RPS, Master, Link/Act/Speed for each port

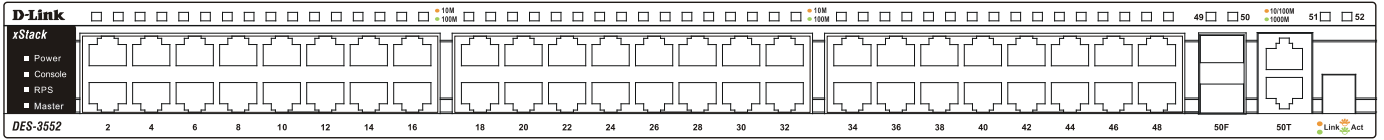

Figure 1- 4. Front Panel View of the DES-3552 switch

DES-3552P

1. Forty-eight 10/100Mbps BASE-T ports
2. Two Combo 1000BASE-T/SFP ports located to the right
3. Two 1000BASE-T ports located to the rear
4. One female DCE RS -232 DB-9 console port
5. One PoE Select Button
6. LEDs for Power, Console, RPS, MS, Link, PoE, Link/Act/Speed for each port

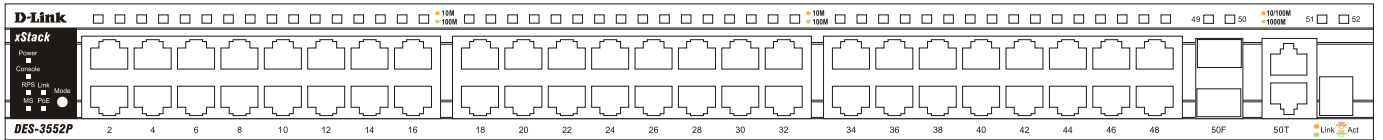

Figure 1- 5. Front Panel View of the DES-3552P switch

LED Indicators

The Switch supports LED indicators for Power, Console, RPS, Master (on DES-3528P and DES-3552P, this LED is for MS) and Port LEDs. The following shows the LED indicators for the DES-3528/DES-3552 switch series along with an explanation of each indicator. LEDs and their corresponding meanings are displayed below.

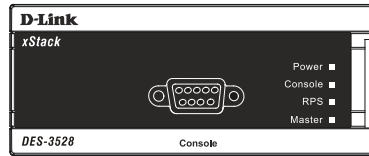

Figure 1- 6. LED Indicators on DES-3528 switch

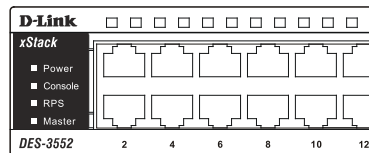

Figure 1- 7. LED Indicators on DES-3552 switch

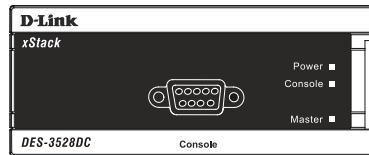

Figure 1- 8. LED Indicators on DES-3528DC switch

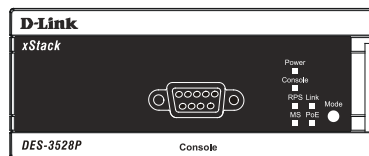

Figure 1- 9. LED Indicators on DES-3528P switch

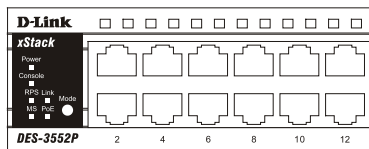

Figure 1- 10. LED Indicators on DES-3552P switch

LED indicators for DES-3528/DES-3528DC/DES-3552/DES-3528P/DES-3552P

Location	LED Indicative	Color	Status	Description
Per Device	Power	Green	Solid Light	Power On
			Light off	Power Off
	Console	Green	Solid Light	Console on
			Blinking	POST is in progress.
			Light off	Console off
	RPS (Not for	Green	Solid Light	RPS is in Use

	DES-3528DC)		Light Off	RPS Off
	Master(MS)	Green	Solid Light	When the device is the stacking master.
			Light off	Not the Stacking Master.
Stacking ID	Green	Capable 1-8	The Box ID is assigned either by the user (static mode) or by the system (automatic mode). When the box becomes a primary master the 7 segments work bi-functionally. The box ID and "H" indicate the primary Master and the display on other switches will be shown in turn. That is boxID- > H -> boxID -> H...	
Mode Select Button (DES-3528P and DES-3552P only)	Link/Act/Speed	Green	Solid Light	Link/Act/Speed Mode
	PoE	Green	Solid Light	PoE Mode
LED Per 10/100 Mbps Port	Link/Act/Speed	Green/Amber	Solid Green	When there is a secure 100Mbps Fast Ethernet connection (or link) at any of the ports.
			Blinking Green	When there is reception or transmission (i.e. Activity—Act) of data occurring at a Fast Ethernet connected port.
			Solid Amber	When there is a secure 10Mbps Ethernet connection (or link) at any of the ports.
			Blinking Amber	When there is reception or transmission (i.e. Activity—Act) of data occurring at an Ethernet connected port.
			Light off	No link
	PoE (DES-3528P and DES-3552P only)	Green	Solid Green	Power device is connected.
			Blinking	Port has detected an error condition.
Light off			Power device may receive power from an AC power source or no 802.3af/802.3at PD is found.	
LED Per GE Port	Link/Act/Speed	Green/Amber	Solid Green	When there is a secure 1000Mbps connection (or link) at any of the ports.
			Blinking Green	When there is reception or transmission (i.e. Activity--Act) of data occurring at a 1000Mbps connected port.
			Solid Amber	When there is a secure 10/100Mbps Fast Ethernet connection (or link) at any of the ports.
			Blinking Amber	When there is reception or transmission (i.e. Activity—Act) of data occurring at a 10/100Mbps Fast Ethernet connected port.

			Light off	No link
LED per SFP Port	Link/Act/Speed	Green/Amber	Solid Green	When there is a secure 1000Mbps connection (or link) at the ports.
			Blinking Green	When there is reception or transmission (i.e. Activity--Act) of data occurring at a 1000Mbps connected port.
			Solid Amber	When there is a secure 100Mbps connection (or link) at any of the ports.
			Blinking Amber	When there is reception or transmission (i.e. Activity—Act) of data occurring at a 100Mbps connected ports.
			Light off	No link

Rear Panel Description

The DES-3528 rear panel contains ports 27 and 28, (1000BASE-T), an AC power connector, and an outlet for an optional external RPS.



Figure 1- 11. Rear panel view of the DES-3528

The DES-3528P rear panel contains ports 27 and 28, (1000BASE-T), an AC power connector, and an outlet for an optional external RPS.

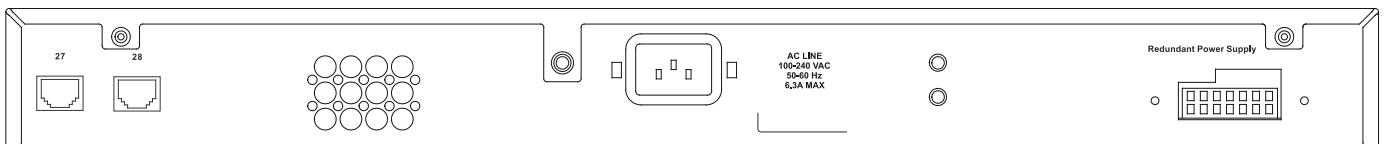

Figure 1- 12. Rear panel view of the DES-3528P

The DES-3552 rear panel contains ports 51 and 52, (1000BASE-T), RS-232 DCE Diagnostic port (console port), an AC power connector, and an outlet for an optional external RPS.

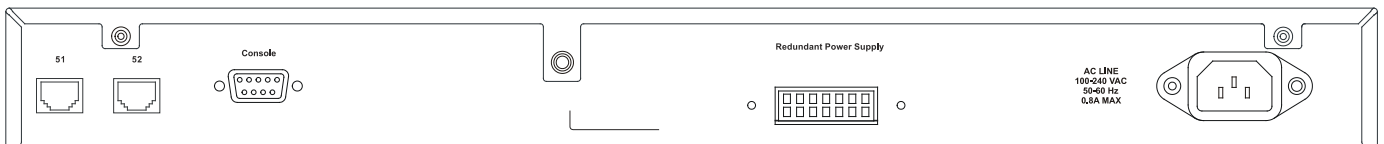

Figure 1- 13. Rear panel view of the DES-3552

The DES-3528P rear panel contains ports 51 and 52, (1000BASE-T), RS-232 DCE Diagnostic port (console port), an AC power connector, and an outlet for an optional external RPS.

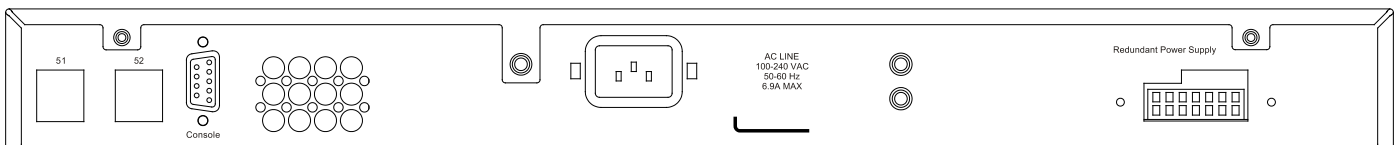

Figure 1- 14. Rear panel view of the DES-3552P

The AC power connector is a standard three-pronged connector that supports the power cord. Plug-in the female connector of the provided power cord into this socket, and the male side of the cord into a power outlet. The Switch automatically adjusts its power setting to any supply voltage in the range from 100 ~ 240 VAC at 50 ~ 60 Hz.

The rear panel also includes an outlet for an optional external power supply. When power fails, the optional external RPS will take over all the power immediately and automatically.

The rear panel of the DES-3528DC includes ports 27 and 28, (1000BASE-T), and an opening designed to accommodate the DC power wiring assembly. See the installation instructions in Section 2 for details.



Figure 1- 15. Rear panel view of the DES-3528DC

Side Panel Description

The left and right-hand panel of the DES-3528 and DES-3528DC Switches contain a heat vent. The heat vents are used to dissipate heat. Do not block these openings, and leave at least 6 inches of space at the rear and sides of the Switch for proper ventilation. Be reminded that without proper heat dissipation and air circulation, system components might overheat, which could lead to system failure.

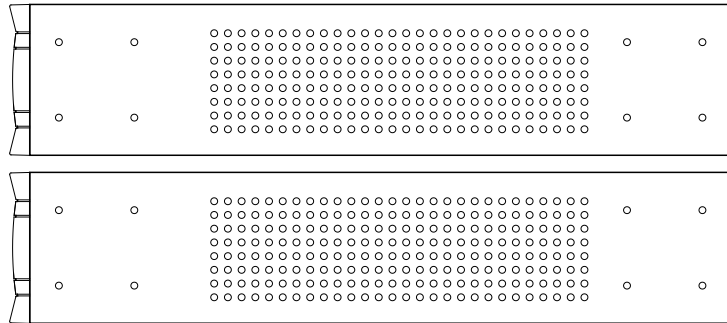

Figure 1-16. Side panels of the DES-3528/DES-3528DC

The right-hand side panel of the DES-3552 and DES-3528P Switches contain two system fans and ventilation along the entire right side. The left hand panel includes a heat vent. The system fans are used to dissipate heat. Do not block these openings on either side of the Switch. Leave at least 6 inches of space at the rear and sides of the Switch for proper ventilation. Be reminded that without proper heat dissipation and air circulation, system components might overheat, which could lead to system failure.

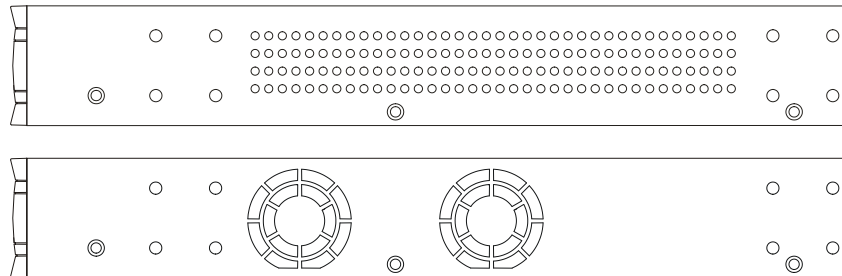

Figure 1-17. Side panels of the DES-3552/DES-3528P

The right-hand side panel of the DES-3552P Switch contains three system fans and ventilation along the entire right side. The left hand panel includes a heat vent. The system fans are used to dissipate heat. Do not block these openings on either side of the Switch. Leave at least 6 inches of space at the rear and sides of the Switch for proper ventilation. Be reminded that without proper heat dissipation and air circulation, system components might overheat, which could lead to system failure.

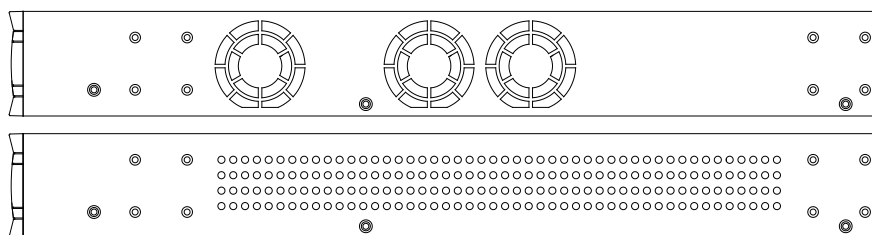

Figure 1-18. Side panels of the DES-3552P

Gigabit Combo Ports

In addition to the 24/48 10/100 Mbps ports, the Switch features two Gigabit Ethernet Combo ports. These two ports are 1000BASE-T copper ports (provided) and SFP ports (optional). See the diagram below to view the two SFP port modules being plugged into the Switch. Please note that although these two front panel modules can be used simultaneously. At the same time, only one copper port or one SFP port can link up for each combo port. The SFP port will always have the highest priority.

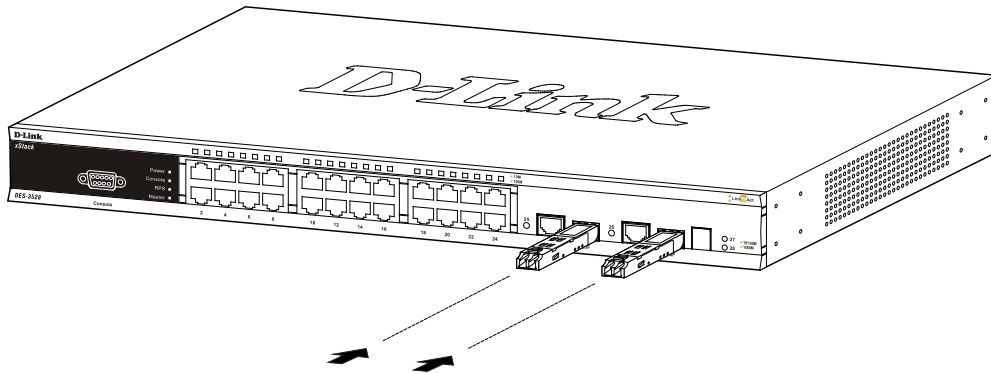

Figure 1- 19. Inserting the SFP modules into the DES-3528/DES-3528P/DES-3528DC/DES-3552/DES-3552P

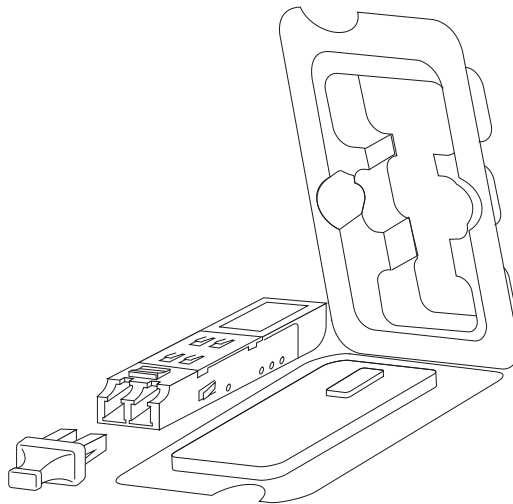

Figure 1-20. Installing the SFP Module

SFP (Mini-GBIC), XENPAK, and XFP Regulatory Compliance Networks pluggable optical modules must meet the following regulatory requirements:

- Class 1 Laser Product
- EN60825-1+A2:2001 or later, European Laser Standard
- FCC 21 CFR Chapter 1, Sub-Chapter J in accordance with FDA & CDRH requirements

Installation

Package Contents

Before You Connect to the Network

Installing the Switch without the Rack

Installing the Switch in a Rack

Mounting the Switch in a Standard 19" Rack

Power On (AC Power)

Power Failure (AC Power)

Connecting DC Power to the DES-3528DC

Package Contents

Open the shipping carton of the Switch and carefully unpack its contents. The carton should contain the following items:

- One xStack® stand-alone switch
- One AC power cord*
- Registration card
- Mounting kit (two brackets and screws)
- Four rubber feet with adhesive backing
- RS-232 console cable

If any item is found missing or damaged, please contact your local D-Link Reseller for replacement.

* Please Note the DES-3528DC Switch does not require an AC power cord therefore none is provided.

Before You Connect to the Network

The site where you install the Switch may greatly affect its performance. Please follow these guidelines for setting up the Switch.

- Install the Switch on a sturdy, level surface that can support at least 6.6 lbs (3 kg) of weight for DES-3528/DES-3528DC, at least 13.2 lbs (6 kg) of weight for DES-3552/DES-3528P, at least 15.4 lbs (7 kg) of weight for DES-3552P. Do not place heavy objects on the Switch.
- The power outlet should be within 1.82 meters (6 feet) of the Switch.
- Visually inspect the power cord and see that it is fully secured to the AC power port.
- Make sure that there is proper heat dissipation from and adequate ventilation around the Switch. Leave at least 10 cm (4 inches) of space at the front and rear of the Switch for ventilation.
- Install the Switch in a fairly cool and dry place for the acceptable temperature and humidity operating ranges.
- Install the Switch in a site free from strong electromagnetic field generators (such as motors), vibration, dust, and direct exposure to sunlight.
- When installing the Switch on a level surface, attach the rubber feet to the bottom of the device. The rubber feet cushions help protect the casing from scratches and prevent it from scratching other surfaces.

Installing the Switch without the Rack

When installing the Switch on a desktop or shelf, the rubber feet included with the Switch should first be attached. Attach these cushioning feet on the bottom at each corner of the device. Allow enough ventilation space between the Switch and any other objects in the vicinity.

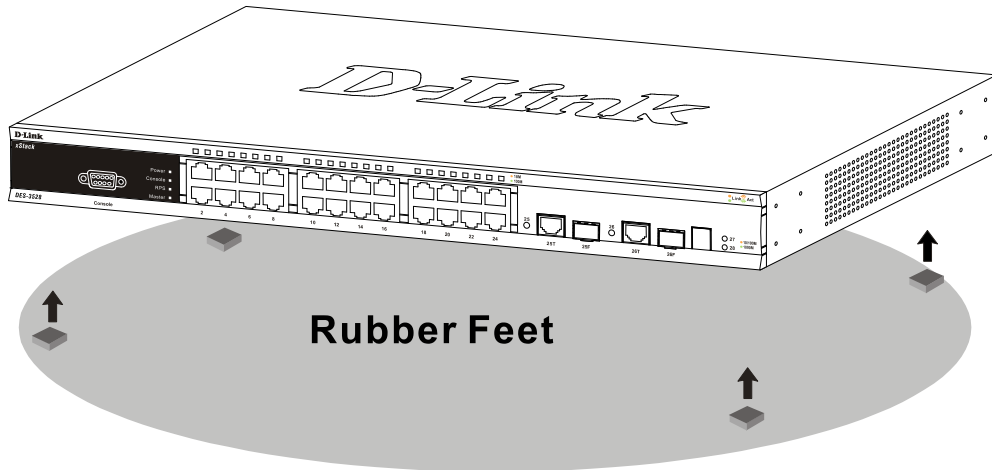

Figure 2- 1. Preparing the Switch for installation on a desktop or shelf

Installing the Switch in a Rack

The Switch can be mounted in a standard 19" rack. Use the following diagrams to guide you.

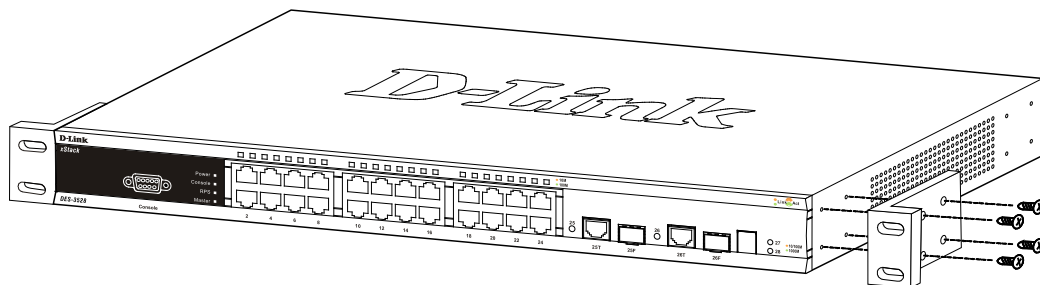

Figure 2- 2. Fasten mounting brackets to the Switch (front)

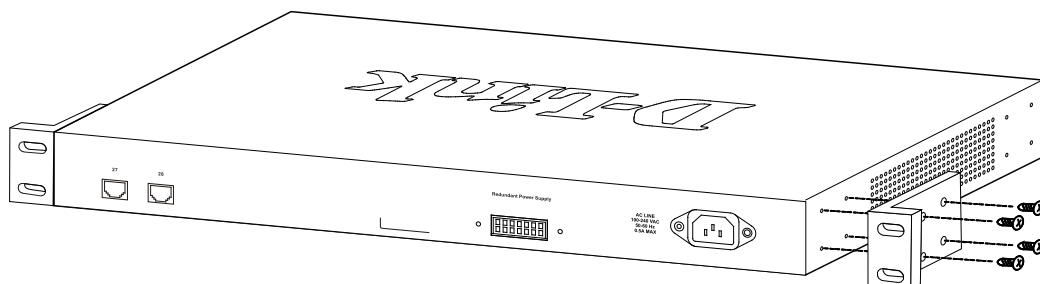

Figure 2- 3. Fasten mounting brackets to the Switch (back)

Fasten the mounting brackets to the Switch using the screws provided. With the brackets attached securely, you can mount the Switch in a standard rack as shown in Figure 2-4.

Mounting the Switch in a Standard 19" Rack



CAUTION: Installing systems in a rack without the front and side stabilizers installed could cause the rack to tip over, potentially resulting in bodily injury under certain circumstances. Therefore, always install the stabilizers before installing components in the rack. After installing components in a rack, do not pull more than one component out of the rack on its slide assemblies at one time. The weight of more than one extended component could cause the rack to tip over and may result in injury.

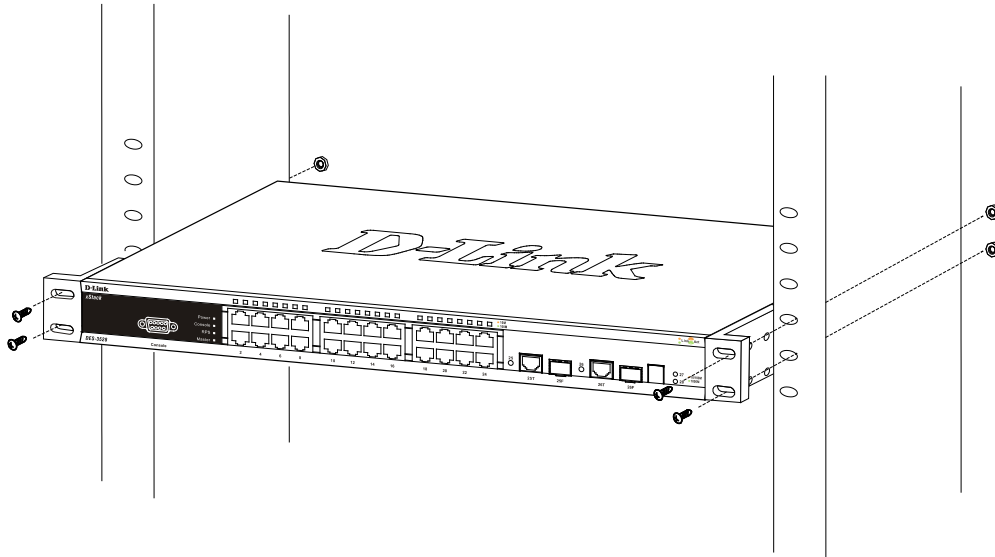

Figure 2- 4. Installing the Switch in a rack (front)

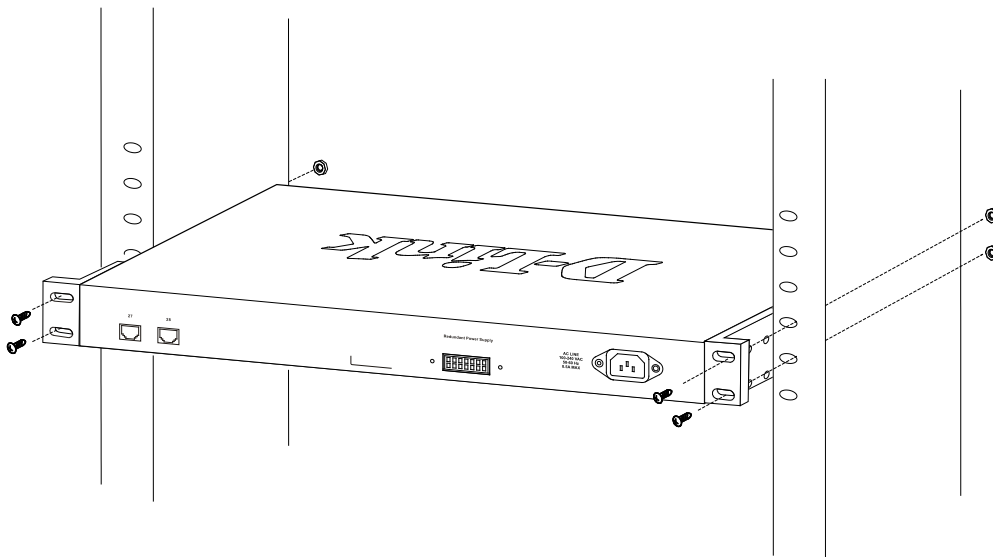

Figure 2- 5. Installing the Switch in a rack (back)

Power On (AC Power)

Plug one end of the AC power cord into the power connector of the Switch and the other end into the local power source outlet. After the Switch is powered on, the LED indicators will momentarily blink. This blinking of the LED indicators represents a reset of the system.

Power Failure (AC Power)

As a precaution for AC power supply units, in the event of a power failure, unplug the Switch. When power has resumed, plug the Switch back in.

Connecting DC Power to the DES-3528DC

Follow the instructions below to connect the DC power supply of the DES-3528DC to the DC power source.



Figure 2- 6. Power connections attached to contacts after assembly

- The DC power supply has a three-terminal wiring block consisting of a positive (+), a negative (-), and a safety ground terminal.
- Firmly attach the DC power to the negative and positive contacts on the wiring assembly.
 - The negative pole (-) connects to the -48V contact.
 - The positive pole (+) connects to the -48V Return contact.
- If available, an earth ground may be connected to the center contact post.
- Tighten the contact screws to secure the connection.



NOTE: Use a minimum 18-gauge (AWG) wire.

All power connection wiring should conform to the rules and regulations in the National Electrical Code (NEC), as well as any local codes. A branch circuit over current protection must be rated between 2A and 10A.



CAUTION: This equipment must be grounded.



CAUTION: This equipment must be installed and maintained by qualified service personnel only.

Connecting the Switch

- Switch to End Node**
- Switch to Hub or Switch**
- Connecting To Network Backbone or Server**



NOTE: All 24/48 high-performance NWay Ethernet ports can support both MDI-II and MDI-X connections.

Switch to End Node

End nodes include PCs outfitted with a 10, 100 or 1000 Mbps RJ-45 Ethernet/Fast Ethernet Network Interface Card (NIC) and most routers. An end node can be connected to the Switch via a twisted-pair Category 3, 4, or 5 UTP/STP cable. The end node should be connected to any of the ports of the Switch.

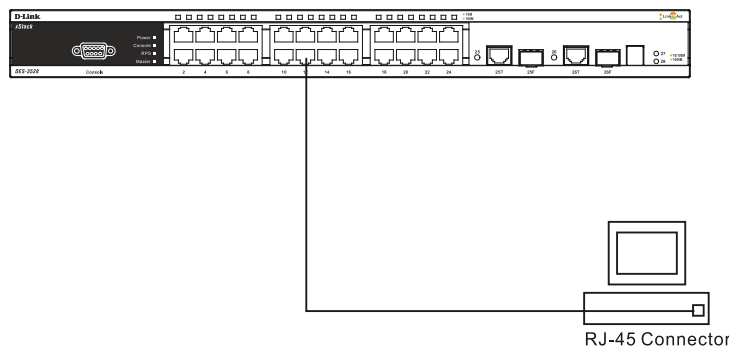

Figure 3- 1. The Switch connected to an end node

The Link/Act LEDs for each UTP port will light green or amber when the link is valid. A blinking LED indicates packet activity on that port.

Switch to Hub or Switch

These connections can be accomplished in a number of ways using a normal cable.

- A 10BASE-T hub or switch can be connected to the Switch via a twisted-pair Category 3, 4 or 5 UTP/STP cable.
- A 100BASE-TX hub or switch can be connected to the Switch via a twisted -pair Category 5 UTP/STP cable.
- A 1000BASE-T hub or switch can be connected to the Switch via a twisted -pair Category 5E UTP/STP cable.

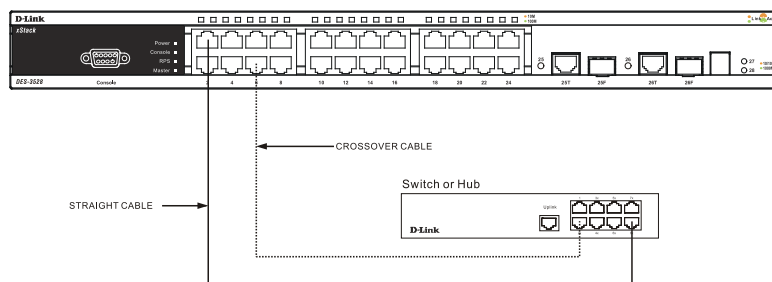

Figure 3- 2. The Switch connected to a normal (non-Uplink) port on a hub or switch using a straight or crossover cable

Connecting To Network Backbone or Server

The two SFP combo ports are ideal for linking to a network backbone or server. The copper ports operate at a speed of 1000, 100 or 10Mbps in full or half duplex mode. The fiber optic ports can operate at 100Mbps or 1000Mbps in full duplex mode.

Connections to the Gigabit Ethernet ports are made using fiber optic cable or Category 5E copper cable, depending on the type of port. A valid connection is indicated when the Link LED is lit.

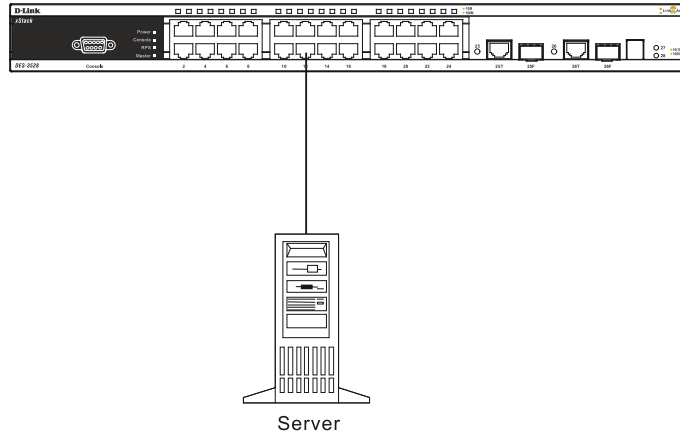

Figure 3- 3. Connecting the Switch to a Server

Introduction to Switch Management

Management Options

Web-based Management Interface

SNMP-Based Management

Connecting the Console Port (RS-232 DCE)

First Time Connecting to the Switch

Password Protection

SNMP Settings

IP Address Assignment

Management Options

This system may be managed out-of-band through the console port on the front panel or in-band using Telnet. The user may also choose the web-based management, accessible through a web browser.

Web-based Management Interface

After you have successfully installed the Switch, you can configure the Switch, monitor the LED panel, and display statistics graphically using a Web browser, such as Mozilla Firefox or Microsoft® Internet Explorer (version 6.0 or later).

SNMP-based Management

You can manage the Switch with an SNMP-compatible console program. The Switch supports SNMP version 1.0, version 2.0 and version 3.0. The SNMP agent decodes the incoming SNMP messages and responds to requests with MIB objects stored in the database. The SNMP agent updates the MIB objects to generate statistics and counters.

Connecting the Console Port (RS-232 DCE)

The Switch provides an RS-232 serial port that enables a connection to a computer or terminal for monitoring and configuring the Switch. This port is a female DB-9 connector, implemented as a data communications equipment (DCE) connection.

To use the console port, you need the following equipment:

A terminal or a computer with both a serial port and the ability to emulate a terminal.

A null modem or Parallel RS-232 cable with a male DB-9 connector for the console port on the Switch.

To connect a terminal to the console port:

- Connect the male connector of the RS-232 cable directly to the console port on the Switch, and tighten the captive retaining screws.
- Connect the other end of the cable to a terminal or to the serial connector of a computer running terminal emulation software. Set the terminal emulation software as follows:
- Select the appropriate serial port (COM port 1 or COM port 2).
- Set the data rate to 115200 baud.
- Set the data format to 8 data bits, 1 stop bit, and no parity.
- Set flow control to none.
- Under Properties, select VT100 for Emulation mode.
- Select Terminal keys for Function, Arrow, and Ctrl keys. Ensure that you select Terminal keys (not Windows keys).



NOTE: When you use HyperTerminal with the Microsoft® Windows® 2000 operating system, ensure that you have Windows 2000 Service Pack 2 or later installed. Windows 2000 Service Pack 2 allows you to use arrow keys in HyperTerminal's VT100 emulation. See www.microsoft.com for information on Windows 2000 service packs.

- After you have correctly set up the terminal, plug the power cable into the power receptacle on the back of the Switch. The boot sequence appears in the terminal.
- After the boot sequence completes, the console login screen displays.
- If you have not logged into the command line interface (CLI) program, press the **Enter** key at the User name and password prompts. There is no default user name and password for the Switch. The administrator must first create user names and passwords. If you have previously set up user accounts, log in and continue to configure the Switch.
- Enter the commands to complete your desired tasks. Many commands require administrator-level access privileges. Read the next section for more information on setting up user accounts. See the **DES-3528/DES-3552 Switch Series CLI Reference Guide** on the documentation CD for a list of all commands and additional information on using the CLI.
- When you have completed your tasks, exit the session with the logout command or close the emulator program.
- Make sure the terminal or PC you are using to make this connection is configured to match these settings.

If you are having problems making this connection on a PC, make sure the emulation is set to VT-100. You will be able to set the emulation by clicking on the **File** menu in your HyperTerminal window, clicking on **Properties** in the drop-down menu, and then clicking the **Settings** tab. This is where you will find the **Emulation** options. If you still do not see anything, try rebooting the Switch by disconnecting its power supply.

Once connected to the console, the screen below will appear on your console screen. This is where the user will enter commands to perform all the available management functions. The Switch will prompt the user to enter a user name and a password. Upon the initial connection, there is no user name or password and therefore just press "enter" twice to access the command line interface.

```
DES-3528 Fast Ethernet Switch
Command Line Interface

Firmware: Build 3.00.012
Copyright(C) 2013 D-Link Corporation. All rights reserved.

Username:
```

Figure 4- 1. Initial screen after first connection

First Time Connecting to the Switch

The Switch supports user-based security that can allow you to prevent unauthorized users from accessing the Switch or changing its settings. This section tells how to log onto the Switch.



NOTE: The passwords used to access the Switch are case-sensitive; therefore, "S" is not the same as "s."

When you first connect to the Switch, you will be presented with the first login screen.



NOTE: Press Ctrl+R to refresh the screen. This command can be used at any time to force the console program in the Switch to refresh the console screen.

Press **Enter** in both the Username and Password fields. You will be given access to the command prompt **DES-3528:admin#** shown below:

There is no initial username or password. Leave the Username and Password fields blank.

```
DES-3528 Fast Ethernet Switch
Command Line Interface

Firmware: Build 3.00.012
Copyright(C) 2013 D-Link Corporation. All rights reserved.

Username:
PassWord:

DES-3528:admin#
```

Figure 4- 2. Command Prompt



NOTE: The first user automatically gets Administrator level privileges. It is recommended to create at least one Admin-level user account for the Switch.

Password Protection

The Switch does not have a default user name and password. One of the first tasks when settings up the Switch is to create user accounts. Once logged in using a predefined administrator-level user name, users will have privileged access to the Switch's management software.

After your initial login, define new passwords for both default user names to prevent unauthorized access to the Switch, and record the passwords for future reference.

To create an administrator-level account for the Switch, follow these steps:

- At the CLI login prompt, enter **create account admin** followed by the *<user name>* and press the **Enter** key.
- The Switch will then prompt the user for a password. Type the *<password>* used for the administrator account being created and press the **Enter** key.
- Again, the user will be prompted to enter the same password again to verify it. Type the same password and press the **Enter** key.
- Successful creation of the new administrator account will be verified by a Success message.



NOTE: Passwords are case sensitive. User names and passwords can be up to 15 characters in length.

The sample below illustrates a successful creation of a new administrator-level account with the user name "newmanager".

```
DES-3528:admin# create account admin newmanager
Command: create account admin newmanager

Enter a case-sensitive new password: *****
Enter the new password again for confirmation: *****

Success.

DES-3528:admin#
```

Figure 4- 3. New administrator level account



NOTICE: CLI configuration commands only modify the running configuration file and are not saved when the Switch is rebooted. To save all your configuration changes in nonvolatile storage, you must use the save command to copy the running configuration file to the startup configuration.

SNMP Settings

Simple Network Management Protocol (SNMP) is an OSI Layer 7 (Application Layer) designed specifically for managing and monitoring network devices. SNMP enables network management stations to read and modify the settings of gateways, routers, switches, and other network devices. Use SNMP to configure system features for proper operation, monitor performance and detect potential problems in the Switch, switch group or network.

Managed devices that support SNMP include software (referred to as an agent), which runs locally on the device. A defined set of variables (managed objects) is maintained by the SNMP agent and used to manage the device. These objects are defined in a Management Information Base (MIB), which provides a standard presentation of the information controlled by the on-board SNMP agent. SNMP defines both the format of the MIB specifications and the protocol used to access this information over the network.

The Switch supports SNMP versions 1, 2c, and 3. You can specify which version of SNMP you want to use to monitor and control the Switch. The three versions of SNMP vary in the level of security provided between the management station and the network device.

In SNMP v.1 and v.2, user authentication is accomplished using 'community strings', which function like passwords. The remote user SNMP application and the Switch SNMP must use the same community string. SNMP packets from any station that has not been authenticated are ignored (dropped).

The default community strings for the Switch used for SNMPv1 and SNMPv2 management access are:

- public - Allows authorized management stations to retrieve MIB objects.
- private - Allows authorized management stations to retrieve and modify MIB objects.

SNMP v.3 uses a more sophisticated authentication process that is separated into two parts. The first part is to maintain a list of users and their attributes that are allowed to act as SNMP managers. The second part describes what each user on that list can do as an SNMP manager.

The Switch allows groups of users to be listed and configured with a shared set of privileges. The SNMP version may also be set for a listed group of SNMP managers. Thus, you may create a group of SNMP managers that are allowed to view read-only information or receive traps using SNMPv1 while assigning a higher level of security to another group, granting read/write privileges using SNMPv3.

Using SNMP v.3 individual users or groups of SNMP managers can be allowed to perform or be restricted from performing specific SNMP management functions. The functions allowed or restricted are defined using the Object Identifier (OID) associated with a specific MIB. An additional layer of security is available for SNMP v.3 in that SNMP

messages may be encrypted. To read more about how to configure SNMP v.3 settings for the Switch read the section entitled Management.

Traps

Traps are messages that alert network personnel of events that occur on the Switch. The events can be as serious as a reboot (someone accidentally turned OFF the Switch), or less serious like a port status change. The Switch generates traps and sends them to the trap recipient (or network manager). Typical traps include trap messages for Authentication Failure, Topology Change and Broadcast\Multicast Storm.

MIBs

The Switch in the Management Information Base (MIB) stores management and counter information. The Switch uses the standard MIB-II Management Information Base module. Consequently, values for MIB objects can be retrieved from any SNMP-based network management software. In addition to the standard MIB-II, the Switch also supports its own proprietary enterprise MIB as an extended Management Information Base. Specifying the MIB Object Identifier may also retrieve the proprietary MIB. MIB values can be either read-only or read-write.

IP Address Assignment

Each Switch must be assigned its own IP Address, which is used for communication with an SNMP network manager or other TCP/IP application (for example BOOTP, TFTP). The Switch's default IP address is 10.90.90.90. You can change the default Switch IP address to meet the specification of your networking address scheme.

The Switch is also assigned a unique MAC address by the factory. This MAC address cannot be changed, and can be found by entering the command "**show switch**" into the command line interface, as shown below.

```
DES-3528:admin# show switch
Command: show switch

Device Type           : DES-3528 Fast Ethernet Switch
MAC Address           : 1C-AF-F7-AD-33-20
IP Address            : 10.90.90.90 (Manual)
VLAN Name             : default
Subnet Mask           : 255.0.0.0
Default Gateway       : 0.0.0.0
Boot PROM Version     : Build 1.00.B008
Firmware Version      : Build 3.00.12
Hardware Version      : A4
Serial Number         : P1UQ3A4000012
System Name           :
System Location       :
System Uptime         : 0 days, 0 hours, 3 minutes, 58 seconds
System Contact        :
Spanning Tree         : Disabled
GVRP                  : Disabled
IGMP Snooping        : Disabled
MLD Snooping          : Disabled
VLAN Trunk            : Disabled
Telnet                : Enabled (TCP 23)
Web                   : Enabled (TCP 80)
SNMP                  : Disabled
CTRL+C  ESC  q  Quit  SPACE  n  Next Page  ENTER  Next Entry  a  All
```

Figure 4- 4. Show switch command

The Switch's MAC address can also be found from the Web management program on the **Switch Information (Basic Settings)** window on the **Configuration** menu.

The IP address for the Switch must be set before it can be managed with the Web-based manager. The Switch IP address can be automatically set using BOOTP or DHCP protocols, in which case the actual address assigned to the Switch must be known.

The IP address may be set using the Command Line Interface (CLI) over the console serial port as follows:

Starting at the command line prompt, enter the command:

```
config ipif System ipaddress xxx.xxx.xxx.xxx/yyy.yyy.yyy.yyy
```

Where the x's represent the IP address to be assigned to the IP interface named System and the y's represent the corresponding subnet mask.

Alternatively, you can enter **config ipif System ipaddress xxx.xxx.xxx.xxx/z**. Where the x's represent the IP address to be assigned to the IP interface named System and the z represents the corresponding number of subnets in CIDR notation.

The IP interface named System on the Switch can be assigned an IP address and subnet mask, and then be used to connect a management station to the Switch's Telnet or Web-based management agent.

```
DES-3528:admin#config ipif System ipaddress 10.90.90.90/255.0.0.0
Command: config ipif System ipaddress 10.90.90.90/8

Success.

DES-3528:admin#
```

Figure 4- 5. Assigning the Switch an IP Address

In the above example, the Switch was assigned an IP address of 10.90.90.90 with a subnet mask of 255.0.0.0. (the CIDR form was used to set the address (10.90.90.90/8). The system message **Success** indicates that the command was executed successfully. The Switch can now be configured and managed via Telnet and the CLI or via the Web-based management.

Web-based Switch Configuration

Introduction

Login to Web Manager

Web-based User Interface

Web Pages

Introduction

The software functions of the Switch can be managed, configured and monitored via the embedded Web-based (HTML) interface. The Switch can be managed from remote stations anywhere on the network through a standard browser such as Mozilla Firefox or Microsoft Internet Explorer. The browser acts as a universal access tool and can communicate directly with the Switch using the HTTP protocol.

Login to Web Manager

To begin managing the Switch, simply run the browser you have installed on your computer and point it to the IP address you have defined for the device. The URL in the address bar should read something like: `http://123.123.123.123`, where the numbers 123 represent the IP address of the Switch.



NOTE: The Factory default IP address for the Switch is 10.90.90.90.

This opens the management module's user authentication window, as seen below.



Figure 5- 1. Enter Network Password dialog

Enter "admin" in both the User Name and Password fields and click **OK**. This will open the Web-based user interface. The Switch management features available in the web-based manager are explained below.

Web-based User Interface

The user interface provides access to various Switch configuration and management windows, allows you to view performance statistics, and permits you to graphically monitor the system status.

Areas of the User Interface

The figure below shows the user interface. The user interface is divided into three distinct areas as described in the table.

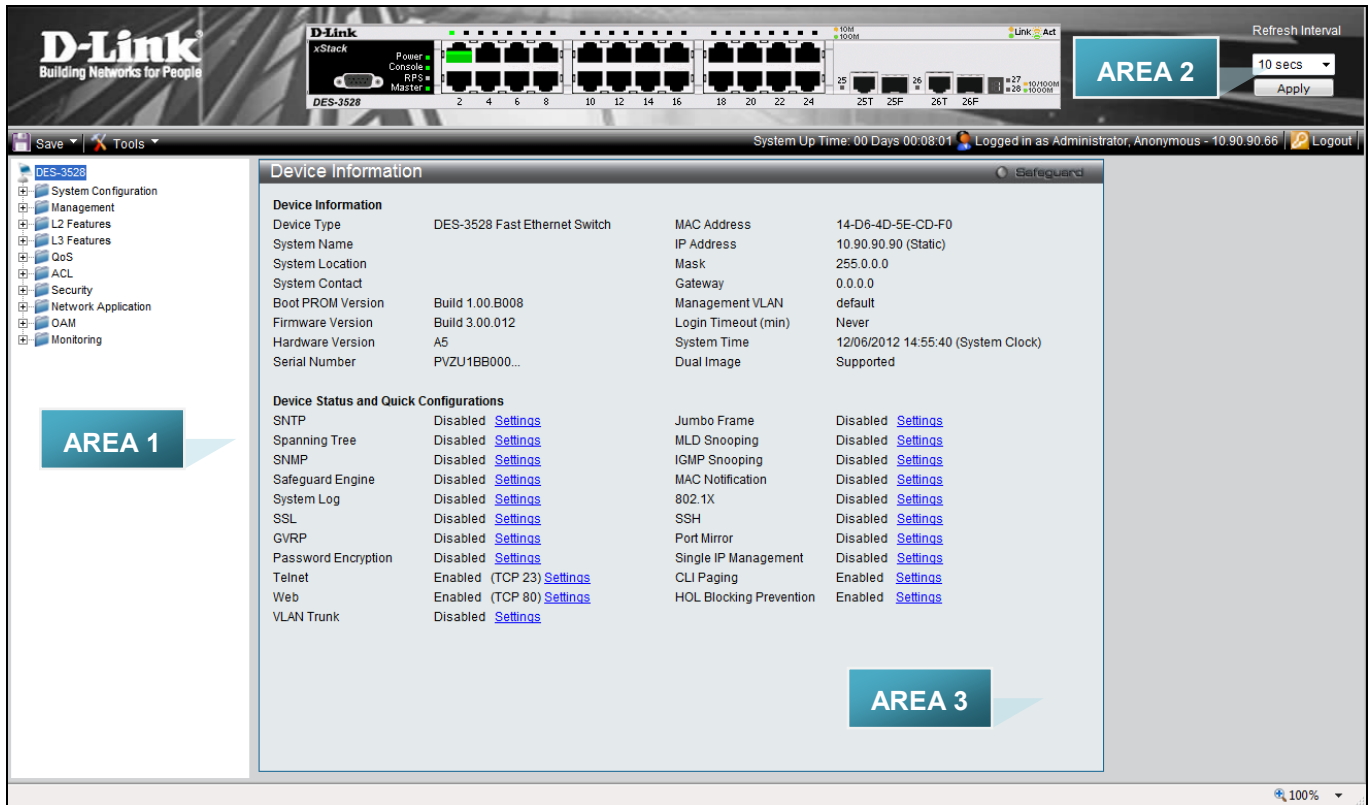

Figure 5- 2. Main Web-Manager page

Area	Function
Area 1	Select the folder or window to be displayed. The folder icons can be opened to display the hyper-linked window buttons and subfolders contained within them. Click the D-Link logo to go to the D-Link Website.
Area 2	Presents a graphical near real-time image of the front panel of the Switch. This area displays the Switch's ports and expansion modules, showing port activity, duplex mode, or flow control, depending on the specified mode. Various areas of the graphic can be selected for performing management functions, including port configuration.
Area 3	Presents switch information based on your selection and the entry of configuration data.



NOTICE: Any changes made to the Switch configuration during the current session must be saved in the Save Changes Web menu (explained below) or use the command line interface (CLI) command save.

Web Pages

When you connect to the management mode of the Switch with a Web browser, a login window is displayed. Enter a user name and password to access the Switch's management mode.

Below is a list and description of the main folders available in the Web interface:

System Configuration – System Information Settings, Dual Configuration Settings, Firmware Information Settings,

Port Configuration, Port Settings, Port Description Settings, Port Error Disabled, Jumbo Frame Settings, PoE, PoE System Settings, PoE Port Settings, Serial Port Settings, System Log Configuration, System Log Settings, System Log Server Settings, System Log, System Log & Trap Settings, System Severity Settings, Time Range Settings, Time Settings, User Accounts Settings, Stacking, Stacking Device Table, and Stacking Mode Settings.

Management – ARP, Static ARP Settings, Proxy ARP Settings, ARP Table, Gratuitous ARP, Gratuitous ARP Global Settings, Gratuitous ARP Settings, IPv6 Neighbor Settings, IP Interface, System IP Address Settings, Interface Settings, Management Settings, Session Table, Single IP Management, Single IP Settings, SNMP Settings, SNMP Global Settings, SNMP Traps Settings, SNMP Linkchange Traps Settings, SNMP View Table Settings, SNMP Community Table Settings, SNMP Group Table Settings, SNMP Engine ID Settings, SNMP User Table Settings, SNMP Host Table Settings, SNMP v6Host Table Settings, RMON Settings, Telnet Settings, and Web Settings.

L2 Features – VLAN, 802.1Q VLAN Settings, 802.1v Protocol VLAN, 802.1v Protocol Group Settings, 802.1v Protocol VLAN Settings, Asymmetric VLAN Settings, GVRP, GVRP Global Settings, GVRP Port Settings, MAC-based VLAN Settings, PVID Auto Assign Settings, Subnet VLAN, Subnet VLAN Settings, VLAN Precedence Settings, VLAN Counter Settings, Voice VLAN, Voice VLAN Global Settings, Voice VLAN Port Settings, Voice VLAN OUI Settings, Voice VLAN Device, VLAN Trunk Settings, Browse VLAN, Show VLAN Ports, Q-in-Q, Q-in-Q Settings, VLAN Translation Settings, Layer 2 Protocol Tunneling Settings, Spanning Tree, STP Bridge Global Settings, STP Port Settings, MST Configuration Identification, STP Instance Settings, MSTP Port Information, Link Aggregation, Port Trunking Settings, LACP Port Settings, FDB, Static FDB Settings, Unicast Static FDB Settings, Multicast Static FDB Settings, MAC Notification Settings, MAC Address Aging Time Settings, MAC Address Table, ARP & FDB Table, L2 Multicast Control, IGMP Snooping, IGMP Snooping Settings, IGMP Snooping Rate Limit Settings, IGMP Snooping Static Group Settings, IGMP Router Port, IGMP Snooping Group, IGMP Snooping Forwarding Table, IGMP Snooping Counter, CPU Filter L3 Control Packet Settings, MLD Snooping, MLD Snooping Settings, MLD Snooping Rate Limit Settings, MLD Snooping Static Group Settings, MLD Router Port, MLD Snooping Group, MLD Snooping Forwarding Table, MLD Snooping Counter, Multicast VLAN, IGMP Multicast Group Profile Settings, IGMP Snooping Multicast VLAN Settings, MLD Multicast Group Profile Settings, MLD Snooping Multicast VLAN Settings, Multicast Filtering, IPv4 Multicast Profile Settings, IPv4 Limited Multicast Range Settings, IPv4 Max Multicast Group Settings, Multicast Filtering Mode, ERPS Settings, LLDP, LLDP Global Settings, LLDP Port Settings, LLDP Management Address List, LLDP Basic TLVs Settings, LLDP Dot1 TLVs Settings, LLDP Dot3 TLVs Settings, LLDP Statistics System, LLDP Local Port Information, and LLDP Remote Port Information.

L3 Features – Local Route Settings, IPv4 Static/Default Route Settings, IPv4 Route Table, IPv6 Static/Default Route Settings, IPv6 Route Table, Policy Route Settings, and IP Forwarding Table.

QoS – 802.1p Settings, 802.1p Default Priority Settings, 802.1p User Priority Settings, 802.1p Map Settings, Bandwidth Control, Bandwidth Control Settings, Queue Bandwidth Control Settings, Traffic Control Settings, DSCP, DSCP Trust Settings, DSCP Map Settings, HOL Blocked Prevention, Scheduling Settings, QoS Scheduling, QoS Scheduling Mechanism, SRED, SRED Settings, and SRED Drop Counter.

ACL – ACL Configuration Wizard, Access Profile List, CPU Access Profile List, ACL Finder, and ACL Flow Meter.

Security – 802.1X, 802.1X Global Settings, 802.1X Port Settings, 802.1X User Settings, Guest VLAN Settings, RADIUS, Authentication RADIUS Server Settings, RADIUS Accounting Settings, RADIUS Authentication, RADIUS Account Client, IP-MAC-Port Binding (IMPB), IMPB Global Settings, IMPB Port Settings, IMPB Entry Settings, MAC Block List, DHCP Snooping, DHCP Snooping Maximum Entry Settings, DHCP Snooping Entry, ND Snoop, ND Snoop Maximum Entry Settings, ND Snoop Entry, MAC-based Access Control (MAC), MAC-based Access Control Settings, MAC-based Access Control Local Settings, MAC-based Access Control Authentication State, Web-based Access Control (WAC), WAC Global Settings, WAC User Settings, WAC Port Settings, WAC Authentication State, Japanese Web-based Access Control (JWAC), JWAC Global Settings, JWAC Port Settings, JWAC User Settings, JWAC Authentication State, JWAC Customize Page Language, JWAC Customize Page, Compound Authentication, Compound Authentication Settings, Compound Authentication Guest VLAN Settings, Port Security, Port Security Settings, Port Security VLAN Settings, Port Security Entries, ARP Spoofing Prevention Settings, BPDU Attack Protection, Loopback Detection Settings, Traffic Segmentation Settings, NetBIOS Filtering Settings, DHCP Server Screening, DHCP Server Screening Port Settings, DHCP Offer Permit Entry Settings, Access Authentication Control, Enable Admin, Authentication Policy Settings, Application Authentication Settings, Authentication Server Group Settings, Authentication Server Settings, Login Method Lists Settings, Enable Method Lists Settings, Local Enable Password Settings, SSL Settings, SSH, SSH Settings, SSH Authentication Method and Algorithm Settings, SSH User Authentication List, Trusted Host Settings, and Safeguard Engine Settings.

Network Application – DHCP, DHCP Relay, DHCP Relay Global Settings, DHCP Relay Interface Settings, DHCP Relay VLAN Settings, DHCP Relay Option 60 Server Settings, DHCP Relay Option 60 Settings, DHCP Relay Option 61 Settings, DHCP Server, DHCP Server Global Settings, DHCP Server Exclude Address Settings, DHCP Server Pool Settings, DHCP Server Manual Binding, DHCP Server Dynamic Binding, DHCP Conflict IP, DHCPv6 Relay, DHCPv6 Relay Global Settings, DHCPv6 Relay Settings, DHCP Local Relay Settings, DNS, DNS Relay, DNS Relay Global Settings, DNS Relay Static Settings, PPPoE Circuit ID Insertion Settings, SNTP, SNTP Settings, and Time Zone Settings.

OAM – CFM, CFM Settings, CFM Port Settings, CFM Loopback Settings, CFM Linktrace Settings, CFM Packet Counter, CFM Fault Table, CFM MP Tabler, Ethernet OAM, Ethernet OAM Settings, Ethernet OAM Configuration

Settings, Ethernet OAM Event Log, Ethernet OAM Statistics, DULD Settings, Cable Diagnostics, .

Monitoring – Utilization, CPU Utilization, DRAM & Flash Utilization, Port Utilization, Statistics, Port Statistics, Packets, Received (RX), UMB_cast (RX), Transmitted (TX), Errors, Received (RX), Transmitted (TX), Packet Size, VLAN Counter Statistics, Mirror, Port Mirror Settings, RSPAN Settings, sFlow, sFlow Global Settings, sFlow Analyzer Server Settings, sFlow Flow Sampler Settings, sFlow Counter Poller Settings, Ping Test, Trace Route, Peripheral, and Device Status.



NOTE: Be sure to configure the user name and password in the **User Accounts** window before connecting the Switch to the greater network.

Appendix A - Technical Specifications

General									
Protocols	IEEE 802.3 10BASE-T Ethernet IEEE 802.3u 100BASE-TX Fast Ethernet IEEE 802.3ab 1000BASE-T Gigabit Ethernet IEEE 802.3z Gigabit Ethernet. (SFP "Mini GBIC") IEEE 802.1D Spanning Tree IEEE 802.1D/S/W Spanning Tree IEEE 802.1Q VLAN IEEE 802.1p Priority Queues IEEE 802.1X Port Based Network Access Control IEEE 802.3ad Link Aggregation Control IEEE 802.3x Full-duplex Flow Control IEEE 802.3 NWay auto-negotiation IEEE 802.3af standard (only for PoE)								
Fiber-Optic	<p>SFP Support:</p> DEM-310GT (1000BASE-LX) DEM-311GT (1000BASE-SX) DEM-314GT (1000BASE-LHX) DEM-315GT (1000BASE-ZX) DEM-312GT2 (1000BASE-SX) DEM-210 (Single Mode 100BASE-FX) DEM-211 (Multi Mode 100BASE-FX)								
	<p>WDM Transceivers Supported:</p> DEM-330T (TX-1550/RX-1310nm), up to 10km, Single-Mode DEM-330R (TX-1310/RX-1550nm), up to 10km, Single-Mode DEM-331T (TX-1550/RX-1310nm), up to 40km, Single-Mode DEM-331R (TX-1310/RX-1550nm), up to 40km, Single-Mode								
Standards	IEEE802.3								
Data Transfer Rates:	<table border="0"> <tr> <td style="padding-right: 20px;">Half-duplex</td> <td>Full-duplex</td> </tr> <tr> <td>Ethernet</td> <td>10 Mbps 20Mbps</td> </tr> <tr> <td>Fast Ethernet</td> <td>100Mbps 200Mbps</td> </tr> <tr> <td>Gigabit Ethernet</td> <td>n/a 2000Mbps</td> </tr> </table>	Half-duplex	Full-duplex	Ethernet	10 Mbps 20Mbps	Fast Ethernet	100Mbps 200Mbps	Gigabit Ethernet	n/a 2000Mbps
Half-duplex	Full-duplex								
Ethernet	10 Mbps 20Mbps								
Fast Ethernet	100Mbps 200Mbps								
Gigabit Ethernet	n/a 2000Mbps								
Topology	Star								
Network Cables	Cat.5 Enhanced for 1000BASE-T UTP Cat.5, Cat. 5 Enhanced for 100BASE-TX UTP Cat.3, 4, 5 for 10BASE-T EIA/TIA-568 100-ohm screened twisted-pair (STP)(100m)								
Number of Ports	<p>DES-3528/DES-3528DC/DES-3528P: 24 x 10/100Base-T Ports, 2 x 1000Base-T/SFP Combo Ports, 2 x 1000Base-T ports</p> <p>DES-3552/DES-3552P: 48 x 10/100Mbps T Ports, 2 x 1000Base-T/SFP Combo Ports, 2 x 1000Base-T ports</p>								

Physical and Environmental	
Internal Power Supply	DES-3528:

	<p>Input: 100~240V, AC/0.5A(Max), 50~60Hz Output: 12V, 1.2A(Max) Internal universal power supply DES-3552: Input: 100~240V, AC/0.8A(Max), 50~60Hz Output: 12V, 2.1A(Max) Internal universal power supply DES-3528P: Input: 100~240V, AC/6.3A(Max), 50~60Hz Output: 50V, 7.5A(Max), 12V, 1.4A(Max) Internal universal power supply DES-3552P: Input: 100~240V, AC/6.9A(Max), 50~60Hz Output: 50V, 7.5A(Max), 12V, 2.65A(Max) Internal universal power supply DES-3528DC: DC Power Input: 36-75 V,DC/ 0.6A (Max) Output: 12V, 1.2A (Max) Internal universal power supply. DES-3528/DES-3552: Provides one connector on the rear panel to install an optional external RPS (DPS-200) to enhance the reliability. When the internal power fails, the optional external RPS will take over all the power immediately and automatically. DES-3528P/DES-3552P: Provides one connector on the rear panel to install an optional external RPS (DPS-600) to enhance the reliability. When the internal power fails, the optional external RPS will take over all the power immediately and automatically.</p>
Power Consumption	<p>DES-3528: Max. 20.5 watts DES-3528DC: Max. 18.38 watts DES-3552: Max. 33.1 watts DES-3528P: Max. 505.1 watts DES-3552P: Max. 506.4 watts</p>
Operating Temperature	<p>DES-3528: A1/A2: 0° to 45° C, A3/A4: 0° to 50° C DES-3528DC: 0° to 45° C DES-3528P: 0° to 50° C DES-3552: A1: 0° to 45° C, A2/A3: 0° to 50° C DES-3552P: 0° to 50° C</p>
Storage Temperature	-40 - 70°C
Humidity	<p>Operation Relative Humidity: 5 - 95% non-condensing. Storage Relative Humidity: 5 – 95% non-condensing.</p>
Dimensions	<p>DES-3528/DES-3528DC: 441(W) x 210(D) x 44(H) mm DES-3552/DES-3528P: 441(W) x 310(D) x 44(H) mm DES-3552P: 441(W) x 370(D) x 44(H) mm</p>
Weight	<p>DES-3528: 2.51kg (5.53lbs) DES-3528DC: 2.52kg (5.55lbs) DES-3552: 4.09kg (9.01lbs) DES-3528P: 5.42kg (11.94lbs) DES-3552P: 6.52kg (14.37lbs)</p>
EMI	CE Class A, FCC Class A, C-Tick, VCCI

Safety	CB Report, UL
---------------	---------------

Performance

Feature	Detailed Description
Wire speed on all FE/GE ports	Full-wire speed (full-duplex) operation on all FE/GE ports
Forwarding Mode	Store and Forward
Switching Capacity	DES-3528/DES-3528DC/DES-3528P: 12.8Gbps DES-3552/DES-3552P: 17.6Gbps
64 Byte system packet forwarding rate	DES-3528/DES-3528DC/DES-3528P: 9.5 million 64-byte packets per second. DES-3552/DES-3552P: 13.1 million 64-byte packets per second.
Priority Queues	8 Priority Queues per port
MAC Address Table	Supports 16K MAC address
Transmission Method	Store-and-forward
Packet Buffer	1 MB per device
Packet Filtering/Forward Rate	14,881 pps (10M port) 148,810 pps (100M port) 1,488,100 pps (1 Gbps port)

Port Functions

Feature	Detailed Description
Console Port	DCE RS-232 DB-9 for out-of-band configuration of the software features.
10/100BaseT ports	Compliant to following standards: IEEE 802.3 compliance IEEE 802.3u compliance Support Half/Full-Duplex operations All ports support Auto MDI-X/MDI-II cross over IEEE 802.3x Flow Control support for Full-Duplex mode, Back Pressure when Half-Duplex mode, and Head-of-line blocking prevention. Compliant IEEE802.3af standard(only for PoE)
Combo ports	2 combo 1000BASE-T/SFP ports 1000BASE-T ports compliant to following standards: IEEE 802.3 compliance IEEE 802.3u compliance IEEE 802.3ab compliance Support Full-Duplex operations IEEE 802.3x Flow Control support for Full-Duplex mode, back pressure when Half-Duplex mode, and Head-of-line blocking prevention SFP Transceivers Supported: DEM-310GT (1000BASE-LX) DEM-311GT (1000BASE-SX) DEM-314GT (1000BASE-LHX) DEM-315GT (1000BASE-ZX) DEM-312GT2 (1000BASE-SX) DEM-210 (Single Mode 100BASE-FX) DEM-211 (Multi Mode 100BASE-FX)

	<p>WDM Transceiver Supported:</p> <p>DEM-330T (TX-1550/RX-1310nm), up to 10km, Single-Mode DEM-330R (TX-1310/RX-1550nm), up to 10km, Single-Mode DEM-331T (TX-1550/RX-1310nm), up to 40km, Single-Mode DEM-331R (TX-1310/RX-1550nm), up to 40km, Single-Mode</p> <p>Compliant to following standards:</p> <p>IEEE 802.3z compliance IEEE 802.3u compliance</p>
1000BASE-T ports	<p>1000BASE-T ports compliant to following standards:</p> <p>IEEE 802.3 compliance IEEE 802.3u compliance IEEE 802.3ab compliance Support Full-Duplex operations IEEE 802.3x Flow Control support for Full-Duplex mode, back pressure when Half-Duplex mode, and Head-of-line blocking prevention</p>

PoE Features DES-3528P and DES-3552P

Feature	Detailed Description																		
PoE Capable Ports	DES-3528P: Port 1-24; DES-3552P: Port 1-48																		
Maximum Power Feeding	<p>DES-3528P: Port 1~8: 30W Port 9~24: 15.4W Device power budget : 370W</p> <p>DES-3552P: Port 1~8: 30W Port 9~48: 15.4W Device power budget : 370W</p>																		
PoE Specification	<p>Compliant with 802.3af PoE standard. And the high power ports (1~8) can support PoE up to 30W.</p> <p>Auto discovery feature, automatically recognize the connection of PD device and immediately sends power to it</p> <p>Auto disable port if the port current is over 350mA for 802.3af mode while other ports remain active</p> <p>Active circuit protection, automatically disables the port if there is a short while other ports remain active</p> <p>PD should be able to receive the power following the classification below:</p> <table border="1" style="width: 100%; border-collapse: collapse;"> <thead> <tr> <th style="text-align: center;">Class</th> <th style="text-align: center;">Usage</th> <th style="text-align: center;">Max power used by PD</th> </tr> </thead> <tbody> <tr> <td style="text-align: center;">0</td> <td style="text-align: center;">Default</td> <td style="text-align: center;">0.44 to 12.95W</td> </tr> <tr> <td style="text-align: center;">1</td> <td style="text-align: center;">Optional</td> <td style="text-align: center;">0.44 to 3.84W</td> </tr> <tr> <td style="text-align: center;">2</td> <td style="text-align: center;">Optional</td> <td style="text-align: center;">3.84 to 6.49W</td> </tr> <tr> <td style="text-align: center;">3</td> <td style="text-align: center;">Optional</td> <td style="text-align: center;">6.49 to 12.95W</td> </tr> <tr> <td style="text-align: center;">4</td> <td style="text-align: center;">Reserved</td> <td style="text-align: center;">12.95W to 30W</td> </tr> </tbody> </table> <p>PSE should be provide the power following the classification below</p>	Class	Usage	Max power used by PD	0	Default	0.44 to 12.95W	1	Optional	0.44 to 3.84W	2	Optional	3.84 to 6.49W	3	Optional	6.49 to 12.95W	4	Reserved	12.95W to 30W
Class	Usage	Max power used by PD																	
0	Default	0.44 to 12.95W																	
1	Optional	0.44 to 3.84W																	
2	Optional	3.84 to 6.49W																	
3	Optional	6.49 to 12.95W																	
4	Reserved	12.95W to 30W																	

Class	Usage	Max power used by PD
0	Default	15.4W
1	Optional	4.0W
2	Optional	7.0W
3	Optional	15.4W
4	Reserved	15.4W ~ 30W

DES-3528P/52P follow the standard PSE pin-out standard of Alternative A which is sending out power over number 1,2,3,6 pins of 8 wires of CAT5 UTP cable

Pin	Signal	Description
1	Receive+ & Power-	Negative Vport
2	Receive- & Power-	Negative Vport
3	Transmit+ & Power+	Positive Vport
4		
5		
6	Transmit- & Power+	Positive Vport
7		
8		

All the PoE ports can work with all D-Link 802.3af capable devices.
All the PoE ports can work with all non-802.3af capable D-Link AP, IP Cam and IP phone via DWL-P50.

FE Port Pin Assignment for Data Pairs: (MDI-X)

PIN#	Signal	Description
1	Receive+	Positive Receive signal
2	Receive-	Negation Receive signal
3	Transmit+	Positive Transmit signal
4		
5		
6	Transmit-	Negation Transmit signal
7		
8		

FE Port PSE Pinout Assignment for Power Pairs: (alternative A MDI-X)

PIN#	Signal	Description
1	Negative Vport	Negative power signal
2	Negative Vport	Negative power signal
3	Positive Vport	Positive power signal
4		

5		
6	Positive Vport	Positive power signal
7		
8		

Appendix B - Cable Lengths

Use the following table to as a guide for the maximum cable lengths.

Standard	Media Type	Maximum Distance
SFP	1000BASE-LX, Single-mode fiber module	10km
	1000BASE-SX, Multi-mode fiber module	550m
	1000BASE-LHX, Single-mode fiber module	40km
	1000BASE-ZX, Single-mode fiber module	80km
1000BASE-T	Category 5e UTP Cable	100m
100BASE-TX	Category 5 and Category 5e UTP Cable (100 Mbps)	100m
10BASE-T	Category 3, 4, 5, and 5e UTP Cable (10 Mbps)	100m

Subject to the terms and conditions set forth herein, D-Link Systems, Inc. ("D-Link") provides this lifetime product warranty for hardware:

- Only for products purchased, delivered and used within the fifty states of the United States, the District of Columbia, U.S. Possessions or Protectorates, U.S. Military Installations, or addresses with an APO or FPO, and;
- Only with proof of purchase.

Product Warranty: D-Link warrants that the hardware portion of the D-Link product, including internal and external power supplies and fans ("Hardware"), will be free from material defects in workmanship and materials under normal use from the date of original retail purchase of the product ("Warranty Period"), except as otherwise stated herein.

The customer's sole and exclusive remedy and the entire liability of D-Link and its suppliers under this Warranty will be, at D-Link's option, to repair or replace the defective Hardware during the Warranty Period at no charge to the owner or to refund the actual purchase price paid. Any repair or replacement will be rendered by D-Link at an Authorized D-Link Service Office. The replacement hardware need not be new or have an identical make, model or part. D-Link may, at its option, replace the defective Hardware or any part thereof with any reconditioned product that D-Link reasonably determines is substantially equivalent (or superior) in all material respects to the defective Hardware. Repaired or replacement hardware will be warranted for the remainder of the original Warranty Period or ninety (90) days, whichever is longer, and is subject to the same limitations and exclusions. If a material defect is incapable of correction, or if D-Link determines that it is not practical to repair or replace the defective Hardware, the actual price paid by the original purchaser for the defective Hardware will be refunded by D-Link upon return to D-Link of the defective Hardware. All Hardware or part thereof that is replaced by D-Link, or for which the purchase price is refunded, shall become the property of D-Link upon replacement or refund.

Software Warranty: D-Link warrants that the software portion of the product ("Software") will substantially conform to D-Link's then current functional specifications for the Software, as set forth in the applicable documentation, from the date of original retail purchase of the Software for a period of ninety (90) days ("Software Warranty Period"), provided that the Software is properly installed on approved hardware and operated as contemplated in its documentation. D-Link further warrants that, during the Software Warranty Period, the magnetic media on which D-Link delivers the Software will be free of physical defects. The customer's sole and exclusive remedy and the entire liability of D-Link and its suppliers under this Limited Warranty will be, at D-Link's option, to replace the non-conforming Software (or defective media) with software that substantially conforms to D-Link's functional specifications for the Software or to refund the portion of the actual purchase price paid that is attributable to the Software. Except as otherwise agreed by D-Link in writing, the replacement Software is provided only to the original licensee, and is subject to the terms and conditions of the license granted by D-Link for the Software. Replacement Software will be warranted for the remainder of the original Warranty Period and is subject to the same limitations and exclusions. If a material non-conformance is incapable of correction, or if D-Link determines in its sole discretion that it is not practical to replace the non-conforming Software, the price paid by the original licensee for the non-conforming Software will be refunded by D-Link; provided that the non-conforming Software (and all copies thereof) is first returned to D-Link. The license granted respecting any Software for which a refund is given automatically terminates.

Non-Applicability of Warranty: The Warranty provided hereunder for D-Link's products will not be applied to and does not cover any products obtained through a special or unique pricing agreement, if such agreement provides for warranty terms different from those normally provided with the product or set forth herein, nor to any refurbished product and any product purchased through the inventory clearance or liquidation sale or other sales in which D-Link, the sellers, or the liquidators expressly disclaim their warranty obligation pertaining to the product and in that case, the product is being sold "As-Is" without any warranty whatsoever including, without limitation, the Warranty as described herein, notwithstanding anything stated herein to the contrary.

Submitting A Claim: The customer shall return the product to the original purchase point based on its return policy. In case the return policy period has expired and the product is within warranty, the customer shall submit a claim to D-Link as outlined below:

- The customer must submit with the product as part of the claim a written description of the Hardware defect or Software nonconformance in sufficient detail to allow D-Link to confirm the same, along with proof of purchase of the product (such as a copy of the dated purchase invoice for the product).
- The customer must obtain a Case ID Number from D-Link Technical Support by going to <https://support.dlink.com>, who will attempt to assist the customer in resolving any suspected defects with the product. If the product is considered defective, the customer must obtain a Return Material Authorization ("RMA") number by completing the RMA form and entering the assigned Case ID Number at <https://rma.dlink.com/>.
- After an RMA number is issued, the defective product must be packaged securely in the original or other suitable shipping package to ensure that it will not be damaged in transit, and the RMA number must be prominently marked on the outside of the package. Include any manuals or accessories in the shipping package.
- The customer is responsible for all in-bound shipping charges to D-Link. No Cash on Delivery ("COD") is allowed. Products sent COD will either be rejected by D-Link or become the property of D-Link. Products shall be fully insured by the customer and shipped to **D-Link Systems, Inc., 17595 Mt. Herrmann, Fountain Valley, CA 92708**. D-Link will not be held responsible for any packages that are lost in transit to D-Link. The repaired or replaced packages will be shipped to the customer via UPS Ground or any common carrier selected by D-Link. Return shipping charges shall be prepaid by D-Link if you use an address in the United States, otherwise we will ship the product to you freight collect. Expedited shipping is available upon request and provided shipping charges are prepaid by the customer.

D-Link may reject or return any product that is not packaged and shipped in strict compliance with the foregoing requirements, or for which an RMA number is not visible from the outside of the package. The product owner agrees to pay D-Link's reasonable handling and return shipping charges for any product that is not packaged and shipped in accordance with the foregoing requirements, or that is determined by D-Link not to be defective or non-conforming.

What Is Not Covered: The Warranty provided herein by D-Link does not cover: Products that, in D-Link's judgment, have been subjected to abuse, accident, alteration, modification, tampering, negligence, misuse, faulty installation, lack of reasonable care, repair or service in any way that is not contemplated in the documentation for the product, or if the model or serial number has been altered, tampered with, defaced or removed; Initial installation, installation and removal of the product for repair, and shipping costs; Operational adjustments covered in the operating manual for the product, and normal maintenance; Damage that occurs in shipment, due to act of God, failures due to power surge, and cosmetic damage; Any hardware, software, firmware or other products or services provided by anyone other than D-Link; and Products that have been purchased from inventory clearance or liquidation sales or other sales in which D-Link, the sellers, or the liquidators expressly disclaim their warranty obligation pertaining to the product. While necessary maintenance or repairs on your Product can be performed by any company, we recommend that you use only an Authorized D-Link Service Office. Improper or incorrectly performed maintenance or repair voids this Warranty.

Disclaimer of Other Warranties: EXCEPT AS SPECIFICALLY SET FORTH ABOVE OR AS REQUIRED BY LAW, THE PRODUCT IS PROVIDED "AS-IS" WITHOUT ANY WARRANTY OF ANY KIND WHATSOEVER INCLUDING, WITHOUT LIMITATION, ANY WARRANTY OF MERCHANTABILITY, FITNESS FOR A PARTICULAR PURPOSE AND NON-INFRINGEMENT. IF ANY IMPLIED WARRANTY CANNOT BE DISCLAIMED IN ANY TERRITORY WHERE A PRODUCT IS SOLD, THE DURATION OF SUCH IMPLIED WARRANTY SHALL BE LIMITED TO NINETY (90) DAYS. EXCEPT AS EXPRESSLY COVERED UNDER THE WARRANTY PROVIDED HEREIN, THE ENTIRE RISK AS TO THE QUALITY, SELECTION AND PERFORMANCE OF THE PRODUCT IS WITH THE PURCHASER OF THE PRODUCT.

Limitation of Liability: TO THE MAXIMUM EXTENT PERMITTED BY LAW, D-LINK IS NOT LIABLE UNDER ANY CONTRACT, NEGLIGENCE, STRICT LIABILITY OR OTHER LEGAL OR EQUITABLE THEORY FOR ANY LOSS OF USE OF THE PRODUCT, INCONVENIENCE OR DAMAGES OF ANY CHARACTER, WHETHER DIRECT, SPECIAL, INCIDENTAL OR CONSEQUENTIAL (INCLUDING, BUT NOT LIMITED TO, DAMAGES FOR LOSS OF GOODWILL, LOSS OF REVENUE OR PROFIT, WORK STOPPAGE, COMPUTER FAILURE OR MALFUNCTION, FAILURE OF OTHER EQUIPMENT OR COMPUTER PROGRAMS TO WHICH D-LINK'S PRODUCT IS CONNECTED WITH, LOSS OF INFORMATION OR DATA CONTAINED IN, STORED ON, OR INTEGRATED WITH ANY PRODUCT RETURNED TO D-LINK FOR WARRANTY SERVICE) RESULTING FROM THE USE OF THE PRODUCT, RELATING TO WARRANTY SERVICE, OR ARISING OUT OF ANY BREACH OF THIS WARRANTY, EVEN IF D-LINK HAS BEEN ADVISED OF THE POSSIBILITY OF SUCH DAMAGES. THE SOLE REMEDY FOR A BREACH OF THE FOREGOING WARRANTY IS REPAIR, REPLACEMENT OR REFUND OF THE DEFECTIVE OR NON-CONFORMING PRODUCT. THE MAXIMUM LIABILITY OF D-LINK UNDER THIS WARRANTY IS LIMITED TO THE PURCHASE PRICE OF THE PRODUCT COVERED BY THE WARRANTY. THE FOREGOING EXPRESS WRITTEN WARRANTIES AND REMEDIES ARE EXCLUSIVE AND ARE IN LIEU OF ANY OTHER WARRANTIES OR REMEDIES, EXPRESS, IMPLIED OR STATUTORY.

Lifetime Warranty: IF LOCAL LAW MANDATES THE USE OF A DEFINITION OF "LIFETIME WARRANTY" DIFFERENT FROM THAT PROVIDED HEREIN, THEN THE LOCAL LAW DEFINITION WILL SUPERSEDE AND TAKE PRECEDENCE, TO THE EXTENT NECESSARY TO COMPLY.

Governing Law: This Warranty shall be governed by the laws of the State of California. Some states do not allow exclusion or limitation of incidental or consequential damages, or limitations on how long an implied warranty lasts, so the foregoing limitations and exclusions may not apply. This Warranty provides specific legal rights and you may also have other rights which vary from state to state.

Trademarks: D-Link is a registered trademark of D-Link Systems, Inc. Other trademarks or registered trademarks are the property of their respective owners.

Copyright Statement: No part of this publication or documentation accompanying this product may be reproduced in any form or by any means or used to make any derivative such as translation, transformation, or adaptation without permission from D-Link Corporation/D-Link Systems, Inc., as stipulated by the United States Copyright Act of 1976 and any amendments thereto. Contents are subject to change without prior notice. Copyright 2009 by D-Link Corporation/D-Link Systems, Inc. All rights reserved.

CE Mark Warning: This is a Class A product. In a residential environment, this product may cause radio interference, in which case the user may be required to take adequate measures.

FCC Statement: This equipment has been tested and found to comply with the limits for a Class A digital device, pursuant to part 15 of the FCC Rules. These limits are designed to provide reasonable protection against harmful interference in a commercial installation. This equipment generates, uses, and can radiate radio frequency energy and, if not installed and used in accordance with the instructions, may cause harmful interference to radio communication. However, there is no guarantee that interference will not occur in a particular installation. Operation of this equipment in a residential environment is likely to cause harmful interference to radio or television reception. If this equipment does cause harmful interference to radio or television reception, which can be determined by turning the equipment off and on, the user is encouraged to try to correct the interference by one or more of the following measures:

- Reorient or relocate the receiving antenna.
- Increase the separation between the equipment and receiver.
- Connect the equipment into an outlet on a circuit different from that to which the receiver is connected.
- Consult the dealer or an experienced radio/TV technician for help.

For detailed warranty information applicable to products purchased outside the United States, please contact the corresponding local D-Link office.

Product Registration

Register your D-Link product online at <http://support.dlink.com/register/>

Product registration is entirely voluntary and failure to complete or return this form will not diminish your warranty rights.

Tech Support

Technical Support

You can find software updates and user documentation on the D-Link website.

D-Link provides free technical support for customers within the United States and within Canada for the duration of the service period, and warranty confirmation service, during the warranty period on this product. U.S. and Canadian customers can contact D-Link technical support through our website, or by phone.

Tech Support for customers within the United States:

D-Link Technical Support over the Telephone:

USA - 877-DLINK-55 (877-354-6555)

D-Link Technical Support over the Internet:

<http://support.dlink.com>

Tech Support for customers within Canada:

D-Link Technical Support over the Telephone:

877-354-6560

D-Link Technical Support over the Internet:

<http://support.dlink.com>

D-Link[®]
Building Networks for People

Technical Support

United Kingdom (Mon-Fri)

Home Wireless/Broadband 0871 873 3000 (9.00am–06.00pm, Sat 10.00am-02.00pm)
Managed, Smart, & Wireless Switches, or Firewalls 0871 873 0909 (09.00am – 05.30pm)
(BT 10ppm, other carriers may vary.)

Ireland (Mon-Fri)

All Products 1890 886 899 (09.00am-06.00pm, Sat 10.00am-02.00pm)
€ 0.05ppm peak, €0.045ppm off peak Times

Internet

<http://dlink.com>

Technische Unterstützung

Deutschland:	Web:	http://dlink.com
	Telefon:	+49(0)1805 2787 0,14 € pro Minute
	Zeiten:	Mo. –Fr. 08:30 – 17:30 Uhr
Österreich:	Web:	http://dlink.com
	Telefon:	+43(0)820 480084 0,116 € pro Minute
	Zeiten:	Mo. –Fr. 08:30 – 17:30 Uhr
Schweiz:	Web:	http://dlink.com
	Telefon:	+41(0)848 331100 0,08 CHF pro Minute
	Zeiten:	Mo. –Fr. 08:30 – 17:30 Uhr

* Gebühren aus Mobilnetzen und von anderen Providern können abweichen.

Assistance technique

Assistance technique D-Link sur internet : <http://dlink.com>
Assistance technique D-Link par téléphone : 01 76 54 84 17
Du lundi au vendredi de 9h à 19h (hors jours fériés)

Asistencia Técnica

Asistencia Técnica Telefónica de D-Link: +34 902 30 45 45
0,067 €/min
De Lunes a Viernes de 9:00 a 19:00
<http://dlink.com>

Supporto tecnico

Supporto Tecnico dal lunedì al venerdì dalle ore 9.00 alle ore 19.00 con orario
continuato
Telefono: 02 87366396
<http://dlink.com>

TECHNISCHE ONDERSTEUNING

Technische ondersteuning voor klanten in Nederland:
<http://dlink.com> / 0107994325 / €0.15per minuut.
Tech Support for customers within Belgium:
<http://dlink.com> / 028801640 / €0.175per minuut(spitsuren), €0.0875per minuut(daluren)
Technische ondersteuning voor klanten in Luxemburg:
<http://dlink.com> / +32 70 66 06 40

Pomoc techniczna

Telefoniczna pomoc techniczna firmy D-Link: 0 801 022 021

Pomoc techniczna firmy D-Link świadczona przez Internet:

<http://dlink.com>

Technická podpora

Web: <http://dlink.com>

E-mail: support@dlink.cz

Telefon ČR: +420 211 151 640 nebo SK: +421 (0)692 147 110

Telefonická podpora je v provozu: PO - PÁ od 09:00 do 17:00

Volání je zpoplatněno dle příslušných tarifů Vašeho operátora.

Technikai Támogatás

Tel. : 06 1 461-3001

Fax : 06 1 461-3004

Land Line 14,99 HUG/min - Mobile 49.99,HUF/min

email : support@dlink.hu

URL : <http://dlink.com>

Teknisk Support

D-Link Teknisk Support over Internett: <http://dlink.com>

D-Link Teknisk telefonsupport: 815 69 755

(Hverdager 08:00 - 17:00)

Teknisk Support

D-Link teknisk support over telefonen: Tlf.: 702 690 40

Normale åbningstider: Hverdage kl. 08:00 - 17:00

D-Link teknisk support på Internettet: <http://dlink.com>

Teknistä tukea asiakkaille Suomessa:

Internetin kautta : <http://dlink.com>

Arkisin klo. 09:00 - 18: 00

Numerosta : 0200-555 57

Teknisk Support

D-Link Teknisk Support via Internet: <http://dlink.com>

D-Link Teknisk Support via telefon: 0770-33 00 35

Vardagar 08:00 - 17:00

Assistência Técnica

Assistência Técnica da D-Link na Internet:

<http://dlink.com>

e-mail: suporte@dlink.es

Τεχνική Υποστήριξη

D-Link Hellas Support Center

<http://dlink.com>

Καλύμνου 12, 112 51, Αθήνα

Τηλ. 213 0020353 (Δευτέρα - Παρασκευή, 09.00 - 19.00)

Fax. 210 8653172

Tehnička podrška

Hvala vam na odabiru D-Link proizvoda. Za dodatne informacije, podršku i upute za korištenje uređaja, molimo vas da posjetite D-Link internetsku stranicu na www.dlink.eu
<http://dlink.com>

Tehnična podpora

Zahvaljujemo se vam, ker ste izbrali D-Link proizvod. Za vse nadaljnje informacije, podporo ter navodila za uporabo prosimo obiščite D-Link - ovo spletno stran www.dlink.eu
<http://dlink.com>

Suport tehnic

Vă mulțumim pentru alegerea produselor D-Link. Pentru mai multe informații, suport și manuale ale produselor vă rugăm să vizitați site-ul D-Link www.dlink.eu
<http://dlink.com>

Technical Support

You can find software updates and user documentation on the D-Link website.

Tech Support for customers in

Australia:

Tel: 1300-766-868
24/7 Technical Support
Web: <http://www.dlink.com.au>
E-mail: support@dlink.com.au

India:

Tel: +91-22-27626600
Toll Free 1800-22-8998
Web: www.dlink.co.in
E-Mail: helpdesk@dlink.co.in

Singapore, Thailand, Indonesia, Malaysia, Philippines, Vietnam:

Singapore - www.dlink.com.sg
Thailand - www.dlink.co.th
Indonesia - www.dlink.co.id
Malaysia - www.dlink.com.my
Philippines - www.dlink.com.ph
Vietnam - www.dlink.com.vn

Korea:

Tel : +82-2-2028-1810
Monday to Friday 9:00am to 6:00pm
Web : <http://d-link.co.kr>
E-mail : g2b@d-link.co.kr

New Zealand:

Tel: 0800-900-900
24/7 Technical Support
Web: <http://www.dlink.co.nz>
E-mail: support@dlink.co.nz

South Africa and Sub Sahara Region:

Tel: +27 12 661 2065
08600 DLINK (for South Africa only)
Monday to Friday 8:30am to 9:00pm South Africa Time
Web: <http://www.d-link.co.za>
E-mail: support@d-link.co.za

Saudi Arabia (KSA):

Tel: +966 01 217 0008
Fax: +966 01 217 0009
Saturday to Wednesday 9.30AM to 6.30PM
Thursdays 9.30AM to 2.00 PM
E-mail: Support.sa@dlink-me.com

D-Link Middle East - Dubai, U.A.E.

Plot No. S31102,
Jebel Ali Free Zone South,
P.O.Box 18224, Dubai, U.A.E.
Tel: +971-4-8809022
Fax: +971-4-8809066 / 8809069
Technical Support: +971-4-8809033
General Inquiries: info.me@dlink-me.com
Tech Support: support.me@dlink-me.com

Egypt

1, Makram Ebeid Street - City Lights Building
Nasrcity - Cairo, Egypt
Floor 6, office C2
Tel.: +2 02 26718375 - +2 02 26717280
Technical Support: +2 02 26738470
General Inquiries: info.eg@dlink-me.com
Tech Support: support.eg@dlink-me.com

Kingdom of Saudi Arabia

Office # 84 ,
Al Khaleej Building (Mujamathu Al-Khaleej)
Opp. King Fahd Road, Olaya
Riyadh - Saudi Arabia
Tel: +966 1 217 0008
Technical Support:
+966 1 2170009 / +966 2 6522951
General Inquiries: info.sa@dlink-me.com
Tech Support: support.sa@dlink-me.com

Pakistan

Islamabad Office:
61-A, Jinnah Avenue, Blue Area,
Suite # 11, EBC, Saudi Pak Tower,
Islamabad - Pakistan
Tel.: +92-51-2800397, 2800398
Fax: +92-51-2800399

Karachi Office:

D-147/1, KDA Scheme # 1,
Opposite Mudassir Park, Karsaz Road,
Karachi – Pakistan
Phone: +92-21-34548158, 34326649
Fax: +92-21-4375727
Technical Support: +92-21-34548310, 34305069
General Inquiries: info.pk@dlink-me.com
Tech Support: support.pk@dlink-me.com

Technical Support

You can find software updates and user documentation on the D-Link website.

Tech Support for customers in

Iran

Unit 5, 5th Floor, No. 20, 17th Alley , Bokharest
St. , Argentine Sq. ,
Tehran IRAN
Postal Code : 1513833817
Tel: +98-21-88880918,19
+98-21-88706653,54
General Inquiries: info.ir@dlink-me.com
Tech Support: support.ir@dlink-me.com

Morocco

M.I.T.C
Route de Nouaceur angle RS et CT 1029
Bureau N° 312 ET 337
Casablanca , Maroc
Phone : +212 663 72 73 24
Email: support.na@dlink-me.com

Lebanon RMA center

Dbayeh/Lebanon
PO Box:901589
Tel: +961 4 54 49 71 Ext:14
Fax: +961 4 54 49 71 Ext:12
Email: taoun@dlink-me.com

Bahrain

Technical Support: +973 1 3332904

Kuwait:

Technical Support: + 965 22453939 / +965
22453949

Türkiye Merkez İrtibat Ofisi

Ayazağa Maslak yolu
Erdebil Cevahir İş Merkezi No: 5/A Ayazağa /
Maslak İstanbul
Tel: +90 212 2895659
Ücretsiz Müşteri Destek Hattı: 0 800 211 00 65
Web:www.dlink.com.tr
Teknik Destek: support.tr@dlink.com.tr

Israel

רח' המגשימים 20
קרית מטלון, פ"ת 49348
ת.ד. 7060
טלפון: 073-796-2797
אי-מאייל כללי: info@dlink.co.il
אי-מאייל תמיכה: support@dlink.co.il

Техническая поддержка

Обновления программного обеспечения и документация доступны на Интернет-сайте D-Link. D-Link предоставляет бесплатную поддержку для клиентов в течение гарантийного срока. Клиенты могут обратиться в группу технической поддержки D-Link по телефону или через Интернет.

Техническая поддержка D-Link:

8-800-700-5465

Техническая поддержка через Интернет:

<http://www.dlink.ru>

e-mail: support@dlink.ru

Офисы

Россия

129626 г. Москва

Графский пер., 14

Тел.: +7 (495) 744-0099

Украина,

04080 г. Киев, ул. Межигорская, 87-А, офис 18

Тел.: +38 (044) 545-64-40

E-mail: kiev@dlink.ru

Беларусь

220114, г. Минск, проспект Независимости, 169, БЦ "XXI Век"

Тел.: +375(17) 218-13-65

E-mail: minsk@dlink.ru

Казахстан,

050008, г. Алматы, ул. Курмангазы, 143

(уг. Муқанова)

Тел./факс: +7 727 378-55-90

E-mail: almaty@dlink.ru

Армения

0038, г. Ереван, ул. Абеяна, 6/1, 4 этаж

Тел./Факс: + 374 (10) 398-667

E-mail: erevan@dlink.ru

Грузия

Тел./Факс: +995 (593) 98-3210

Lietuva

09120, Vilnius, Žirmūnų 139-303

Tel./faks. +370 (5) 236-3629

E-mail: info@dlink.lt

Eesti

Mustamae 55-314

10621, Tallinn

Tel +372 613 9771

e-mail: info@dlink.ee

Latvija

Mazā nometņu 45/53 (ieeja no Nāras ielas)

LV-1002, Rīga

Tel.:+371 7 618-703

Fax: +371 7 618-706

e-pasts: info@dlink.lv

SOPORTE TÉCNICO

Usted puede encontrar actualizaciones de softwares o firmwares y documentación para usuarios a través de nuestro sitio www.dlinkla.com

SOPORTE TÉCNICO PARA USUARIOS EN LATINO AMERICA

Soporte técnico a través de los siguientes teléfonos de D-Link

PAIS	NUMERO
Argentina	0800 - 12235465
Chile	800 260200
Colombia	01800 - 510070
Costa Rica	0800 - 0521478
Ecuador	1800 - 035465
El Salvador	800 - 6335
Guatemala	1800 - 8350255
México	01800 - 0626270
Panamá	011 008000525465
Perú	0800 - 00968
Venezuela	0800 - 1005767

Soporte Técnico de D-Link a través de Internet

Horario de atención Soporte Técnico en www.dlinkla.com

e-mail: soporte@dlinkla.com & consultas@dlinkla.com

D-Link[®]
Building Networks for People

Suporte Técnico

Caso tenha dúvidas na instalação do produto, entre em contato com o Suporte Técnico D-Link.

Acesse o site: www.dlink.com.br/suporte



D-Link 友訊科技 台灣分公司 技術支援資訊

如果您還有任何本使用手冊無法協助您解決的產品相關問題，台灣地區用戶可以透過我們的網站、電子郵件或電話等方式與D-Link台灣地區技術支援工程師聯絡。

D-Link 免付費技術諮詢專線

0800-002-615

手機付費電話 (02)6600-0123#8715

服務時間：週一至週五，早上9:00到晚上9:00

(不含周六、日及國定假日)

網 站：<http://www.dlink.com.tw>

電子郵件：dssqa_service@dlink.com.tw

如果您是台灣地區以外的用戶，請參考D-Link網站全球各地分公司的聯絡資訊以取得相關支援服務。

產品保固期限、台灣區維修據點查詢，請參考以下網頁說明：

<http://www.dlink.com.tw>

產品維修：

使用者可直接送至全省聯強直營維修站或請洽您的原購買經銷商。

D-Link®
Building Networks for People

Dukungan Teknis

Update perangkat lunak dan dokumentasi pengguna dapat diperoleh pada situs web D-Link.

Dukungan Teknis untuk pelanggan:

Dukungan Teknis D-Link melalui telepon:

Tel: +62-21-5731610

Dukungan Teknis D-Link melalui Internet:

Email : support@dlink.co.id

Website : <http://support.dlink.co.id>



Technical Support

この度は弊社製品をお買い上げいただき、誠にありがとうございます。
させていただきます。

下記弊社 Web サイトからユーザ登録及び新製品登録を
行っていただき、ダウンロードサービスにて
サポート情報、ファームウェア、ユーザマニュアルを
ダウンロードすることができます。

ディーリンクジャパン Web サイト

URL:<http://www.dlink-jp.com>

D-Link®
Building Networks for People

技术支持

办公地址：北京市东城区北三环东路 36 号 环球贸易中心 B 座
26F 02-05 室 邮编: 100013

技术支持中心电话：400-629-6688

技术支持中心传真：(028) 87300889

各地维修中心地址请登陆官方网站查询

网址：<http://www.dlink.com.cn>

400电话工作时间：工作日9:00-19:00；节假日9:00-18:00.

D-Link[®]
Building Networks for People

Registration Card

All Countries and Regions Excluding USA

Print, type or use block letters.

Your name: Mr./Ms _____

Organization: _____ Dept. _____

Your title at organization: _____

Telephone: _____ Fax: _____

Organization's full address: _____

Country: _____

Date of purchase (Month/Day/Year): _____

Product Model	Product Serial No.	* Product installed in type of computer	* Product installed in computer serial No.

(* Applies to adapters only)

Product was purchased from:

Reseller's name: _____

Telephone: _____

Answers to the following questions help us to support your product:

1. Where and how will the product primarily be used?

Home Office Travel Company Business Home Business Personal Use

2. How many employees work at installation site?

1 employee 2-9 10-49 50-99 100-499 500-999 1000 or more

3. What network protocol(s) does your organization use ?

XNS/IPX TCP/IP DECnet Others _____

4. What network operating system(s) does your organization use ?

D-Link LANsmart Novell NetWare NetWare Lite SCO Unix/Xenix PC NFS 3Com 3+Open Cisco Network

Banyan Vines DECnet Pathwork Windows NT Windows 98 Windows 2000/ME Windows XP

Others _____

5. What network management program does your organization use ?

D-View HP OpenView/Windows HP OpenView/Unix SunNet Manager Novell NMS

NetView 6000 Others _____

6. What network medium/media does your organization use ?

Fiber-optics Thick coax Ethernet Thin coax Ethernet 10BASE-T UTP/STP

100BASE-TX 1000BASE-T Wireless 802.11b and 802.11g wireless 802.11a Others _____

7. What applications are used on your network?

Desktop publishing Spreadsheet Word processing CAD/CAM

Database management Accounting Others _____

8. What category best describes your company?

Aerospace Engineering Education Finance Hospital Legal Insurance/Real Estate Manufacturing

Retail/Chain store/Wholesale Government Transportation/Utilities/Communication VAR

System house/company Other _____

9. Would you recommend your D-Link product to a friend?

Yes No Don't know yet

10. Your comments on this product?

PLEASE
PLACE STAMP
HERE

TO:

D-Link®