

D-Link[®]

DES-6300

**Modular L3 Ethernet Switch
User's Guide**

First Edition (July,2002)

651ES6300015

Printed In Taiwan



RECYCLABLE

Features

The DES-6300 is a high performance modular switch platform that allows a customized array of Layer 2 and Layer 3 functions to be easily installed and managed in a single device. The Switch is ideal for expanding enterprise networks and environments where traffic volume and needs fluctuate.

Switch features include:

Chassis

The chassis is the main unit that modules and power supplies are installed into. A CPU module and a power supply module come preinstalled in the chassis.

Chassis features include:

- ◆ Six slots for installing networking modules (plus one slot reserved for the CPU)
- ◆ Two slots for installing redundant power supply modules
- ◆ 31.99 Gigabit/sec. (Gbps) backplane switching fabric
- ◆ Hot-swappable design for power supply modules
- ◆ Networking modules warm-swappable (except CPU module)
- ◆ Ears and screws for rack mounting

Switch Modules

The plug-in modules available for the switch are optional except for the CPU module. These modules are described below:

CPU Module

A single CPU module must be present and must be installed in first (uppermost) slot.

Layer 2 support includes:

- ◆ Layer 2 switching based on MAC address & VLAN ID.
- ◆ Store and Forward packet switching.
- ◆ Broadcast Storm rate filtering.
- ◆ Supports static filtering (based on MAC address).
- ◆ Supports IEEE 802.1Q VLAN (Static VLAN).
- ◆ Proprietary simplified Port-based VLANs
- ◆ IEEE 802.1d Spanning Tree support.
- ◆ Address table: 64K MAC address per switch
- ◆ 96 Static VLAN Entries (in IEEE 802.1Q VLANs mode)
- ◆ Supports 802.1p priority queuing (2 priority queues)
- ◆ Port Aggregation (Port-Trunking) Capability
- ◆ Port Mirroring
- ◆ IGMP snooping
- ◆ Head Of Line (HOL) Blocking Prevention

- ◆ RS-232 port for out-of-band management and system configuration
- ◆ Telnet Remote Configuration
- ◆ TFTP software upgrades, settings file and switch log uploads
- ◆ NMS(Net Management System)
- ◆ CLI (Command Line Interface)
- ◆ SNMP Agents:
 - ◆ MIB-II (RFC 1213)
 - ◆ RMON MIB (RFC 1757)
 - ◆ Bridge MIB (RFC 1493)
- ◆ SLIP
- ◆ Supports four RMON (1,2,3,9) groups
- ◆ Port Security
- ◆ BootP support

Layer 3 support includes:

- ◆ Support for DHCP Client
- ◆ Support RIP1 and RIP2 routing protocol
- ◆ Support OSPF routing protocol
- ◆ Support IGMP, IP Multicast packet filtering, support QoS (Quality of Service).
- ◆ Support Multicast Routing protocol: DVMRP, PIM DM
- ◆ Support Layer 3 Access Control List, (ACL)

Optional Modules

DES-6303 10BASE-T/100BASE-TX Module

- ◆ 16 10BASE-T/100BASE-TX ports
- ◆ Fully compliant with IEEE 802.3 10BASE-T, IEEE 802.3u 100BASE-TX
- ◆ All 10/100Mbps ports support NWay auto-negotiation
- ◆ Back pressure Flow Control support for Half-duplex mode
- ◆ IEEE 802.3x-compliant Flow Control support for Full-duplex

DES-6304 100BASE-FX (MT-RJ) Module

- ◆ 12 100BASE-FX (MT-RJ) Fast Ethernet ports
- ◆ Fully compliant with IEEE 802.3u 100BASE-FX
- ◆ IEEE 802.3x compliant Flow Control support for Full-duplex

DES-6305 100BASE-FX (SC) Module

- ◆ 8 100BASE-FX (SC) Fast Ethernet ports
- ◆ Connects to a 100BASE-FX device at full duplex.
- ◆ Fully compliant with IEEE 802.3u 100BASE-FX
- ◆ Supports Full-duplex operation only
- ◆ IEEE 802.3x-compliant Flow Control support

DES-6306 1000BASE-SX (SC) Module

- ◆ 2 1000BASE-SX (SC) Gigabit Ethernet ports
- ◆ Fully compliant with IEEE 802.3z
- ◆ Support Full-duplex operation only
- ◆ IEEE 802.3x-compliant Flow Control support

DES-6307 1000BASE-LX (SC) Module

- ◆ 2 1000BASE-LX (SC) Gigabit Ethernet ports
- ◆ Fully compliant with IEEE 802.3z
- ◆ Support Full-duplex operation only
- ◆ IEEE 802.3x-compliant Flow Control support

DES-6308 1000BASE-T (RJ-45) Module

- ◆ 2 1000BASE-T Gigabit Ethernet ports
- ◆ Connects to 1000BASE-T devices only at full-duplex and auto-negotiating 10/100/1000 Mbps ports
- ◆ Fully compliant with IEEE 802.3ab
- ◆ Fully compliant with IEEE 802.1Q/P
- ◆ Back pressure Flow Control support for Half-duplex mode
- ◆ IEEE 802.3x compliant Flow Control support for Full-duplex

DES-6309 GBIC Module

- ◆ 2 GBIC Ethernet ports
- ◆ Fully compliant with IEEE 802.3z
- ◆ Support Full-duplex operation only
- ◆ IEEE 802.3x-compliant Flow Control support

Power Supply Modules

- ◆ Dual power modules design
- ◆ Current sharing design
- ◆ Full redundant feature design to ensure continuous operation
- ◆ If one power module fails, the other will take over all current supply automatically.
- ◆ Hot-swappable/Hot-pluggable
- ◆ Power management functions enabled
- ◆ Revolving handle design
- ◆ Input: 90 ~ 264 VAC, 47 ~ 63Hz
- ◆ Output: 3.3V 80A Max, 12V 2A Max

UNPACKING AND SETUP

This chapter provides unpacking and setup information for the Switch.

Unpacking

Open the shipping carton of the Switch and carefully unpack its contents. The carton should contain the following items:

- ◆ One switch chassis
- ◆ One management module (pre-installed in uppermost slot)
- ◆ One power supply module (pre-installed)
- ◆ One mounting kit : four mounting brackets and screws
- ◆ Four rubber feet with adhesive backing
- ◆ One AC power cord
- ◆ One console cable
- ◆ One printed copy of the quickstart guide
- ◆ One CD-ROM containing this user's guide

If any item is found missing or damaged, please contact your local reseller for replacement.

Setup

The setup of the Switch can be performed using the following steps:

- ◆ The surface must support at least 5 kg.
- ◆ The power outlet should be within 1.82 meters (6 feet) of the device.
- ◆ Visually inspect the power cord and see that it is secured fully to the AC power connector.
- ◆ Make sure that there is proper heat dissipation from and adequate ventilation around the Switch. Do not place heavy objects on the Switch.

Desktop or Shelf Installation

When installing the Switch on a desktop or shelf, the rubber feet included with the device must be first attached. Attach these cushioning feet on the bottom at each corner of the device. Allow enough ventilation space between the device and the objects around it.

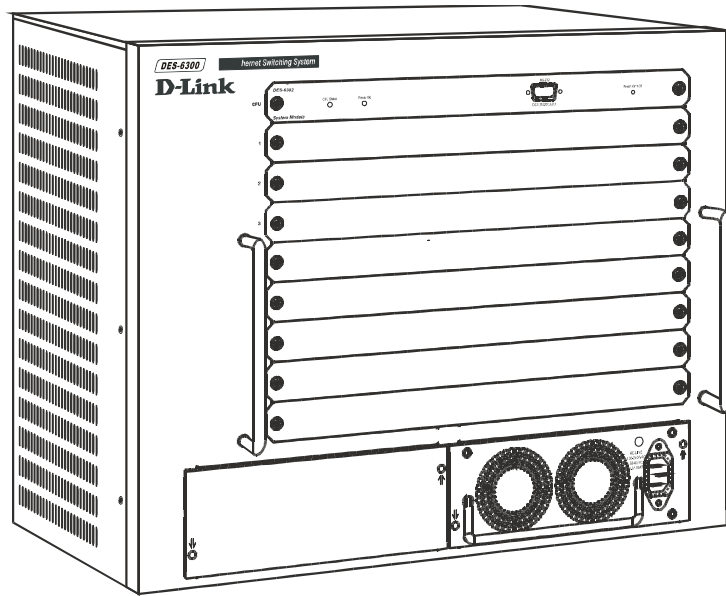

Figure 2-1. Switch installed on a Desktop or Shelf

Rack Installation

The Switch can be mounted in an EIA standard size, 19-inch rack, which can be placed in a wiring closet with other equipment. To install, attach the mounting brackets on the Switch's front panel (one on each side) and secure them with the screws provided.

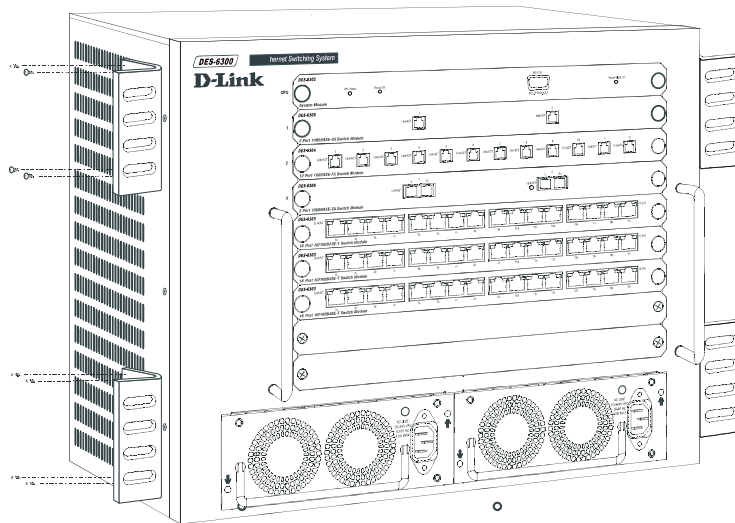

Figure 2-2. Attaching the mounting brackets to the Switch

Then, use the screws provided with the equipment rack to mount the Switch in the rack.

Installing Modules

The DES-6300 supports up to 6 modules which can be installed into the module bays. Networking modules are warm-swappable, meaning they can be added and removed while power to the switch is ON. After warm-swapping a networking module, the switch will automatically be rebooted. Make sure to use the Save Changes command to save the current configuration to NV-RAM before warm-swapping modules. The CPU module, however, is NOT hot-swappable. Removing or inserting the CPU module while the power is on may cause irreparable damage to the module and/or to the Switch itself. Further, make sure you have unplugged the power cord from the removable power supply module before inserting or removing it from the Switch.

CAUTION: Due to the high energy present in this system, extreme caution should be exercised whenever adding or removing system components. No element of this system may be installed or removed except by an authorized technician.

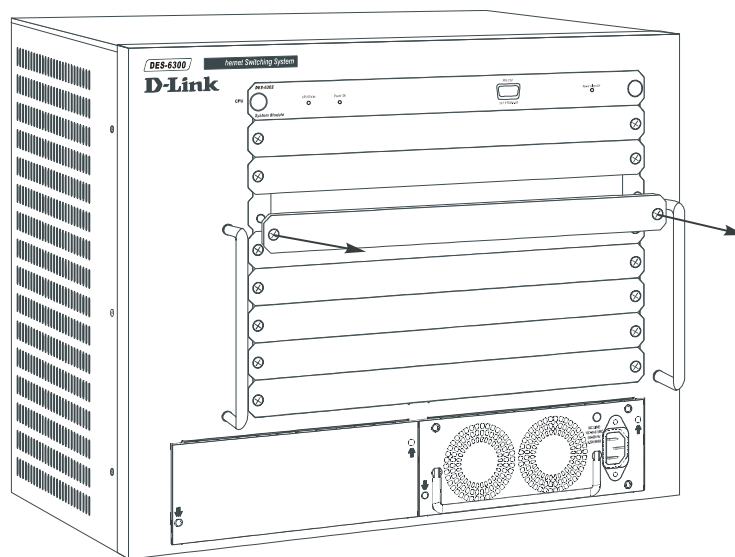

Figure 2-3. Removing a Blank Slot Cover

Modules can be installed into any free slot, except the CPU module. The CPU module must be installed in the uppermost (top) slot. To install a module, simply remove a blank slot cover and slide the module along the guide rails until it snaps firmly in place.

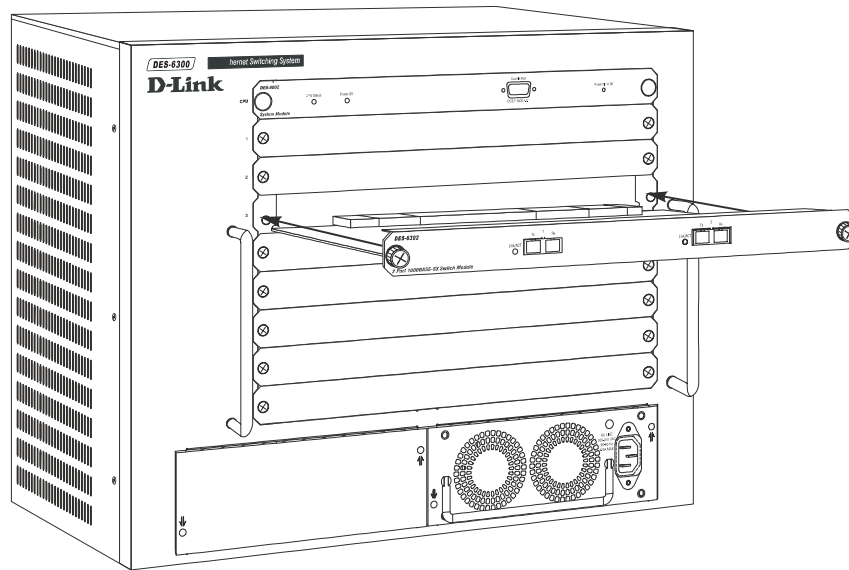

Figure 2-4. Installing a Module

Connecting a Terminal

The DES-6300 can perform basic switching functions without special configuration, but to use the Switch's advanced features you must first configure the unit through a terminal (a VT-100 serial data terminal or a computer running a VT-100 emulator). The connection is made through the Switch's Diagnostic RS-232 port, which is configured at the factory as follows:

- ◆ Baud Rate: 115200
- ◆ Data Bits: 8
- ◆ Parity: none
- ◆ Stop Bits: 1
- ◆ Flow Control: None

The RS-232 port has a nine-socket D-shell connector with IBM-type DCE wiring, and can be connected to the terminal using an off-the-shelf RS-232 cable with the proper connectors for the terminal and the DES-6300.

Power on

Power up the DES-6300 as follows:

1. Make sure the power module is properly installed in the device.
2. Plug the device end of the supplied power cord firmly into the power inlet on the DES-6300's front panel of the redundant power supply.
3. Plug the outlet end of the power cord firmly into a suitable AC outlet.
4. Observe the DES-6300's LED indicators to make sure the Switch is operating correctly.

The DES-6300's LED indicators operate as follows during a normal power-up:

- ◆ All indicators blink momentarily to indicate a system reset.
- ◆ The Power indicator flashes for about 20 seconds while the switch prepares its run-time software and performs a self-test.
- ◆ The Power indicator begins shining steadily, and the remaining indicators begin reflecting port and system status.

Power Failure

As a precaution, the Switch should be unplugged in case of an impending power failure. When power is resumed, plug the Switch back in.

IDENTIFYING EXTERNAL COMPONENTS

This chapter describes the front panel, side panels, optional plug-in modules, and LED indicators of the Switch

Front Panel

The front panel of the Switch consists nine slide-in module slots for networking modules, two slide-in module slots for power supply modules, an RS-232 communication port, and LED indicators.

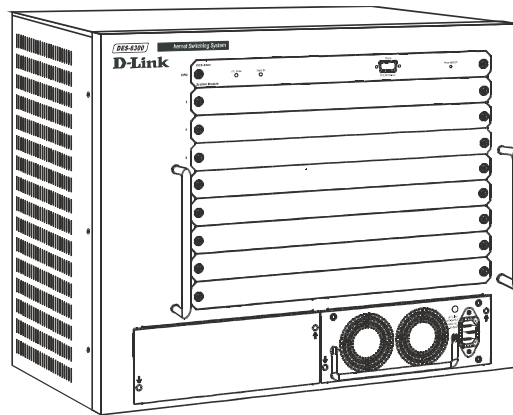

Figure 3-1. Front panel view of the Switch

- ◆ Comprehensive LED indicators display the conditions of the Switch and status of the network. A description of these LED indicators follows (see *LED Indicators*).
- ◆ An RS-232 DCE console port is used to diagnose the Switch via a connection to a terminal (or PC) and Local Console Management.
- ◆ Seven slide-in module slots installing networking modules and the CPU module.
- ◆ Two slide-in module slots for installing power supply modules.

Side Panels

The left side panel of the Switch contains four system fans. The right side panel contains heat vents.

The system fans are used to dissipate heat. The sides of the system also provide heat vents to serve the same purpose. Do not block these openings, and leave adequate space at the rear and sides of the Switch for proper ventilation. Be reminded that without proper heat dissipation and air circulation, system components might overheat, which could lead to system failure.

Optional Plug-in Modules

The DES-6300 Modular Ethernet Switch is able to accommodate a range of plug-in modules in order to increase functionality and performance.

DES-6303 10BASE-T/100BASE-TX Module

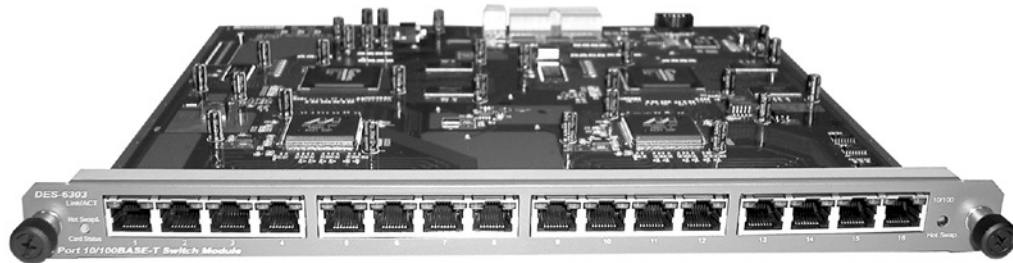

Figure 3-2. 16-port, 10/100BASE-TX module

- ◆ 16-port, front-panel module.
- ◆ Connects to 10BASE-T and 100BASE-TX devices at full- or half-duplex.
- ◆ Supports Category 3, 4, 5 or better UTP or STP connections of up to 100 meters each.

DES-6304 100BASE-FX (MT-RJ) Module

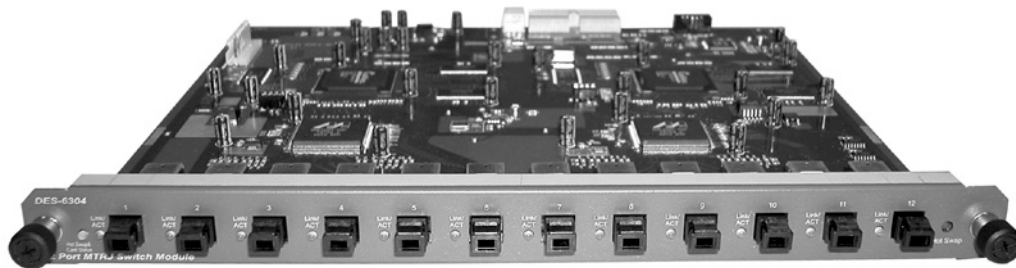

Figure 3-3. 12-port, 100BASE-FX (MT-RJ) module

100BASE-FX (MT-RJ) Module *continued*

- ◆ 12-port, front-panel module.
- ◆ Connects to 100BASE-FX devices at full- or half-duplex.
- ◆ 12 100BASE-FX (MT-RJ) Fast Ethernet ports
- ◆ Fully compliant with IEEE 802.3u 100BASE-FX
- ◆ IEEE 802.3x compliant Flow Control support for Full duplex

DES-6305 100BASE-FX (SC) Gigabit Module

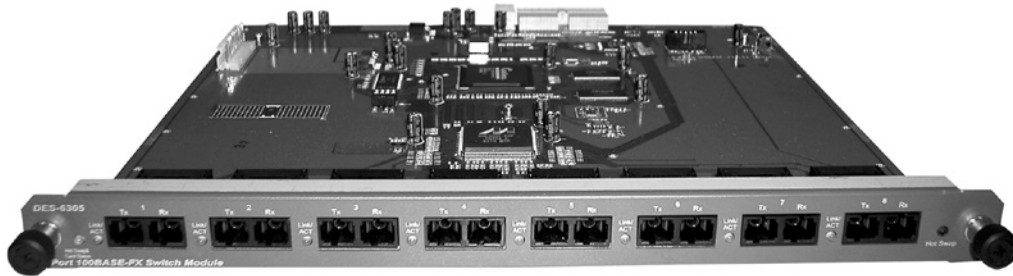

Figure 3-4. 8-port, 100BASE-FX (SC) module

- ◆ 8-port, front panel module.
- ◆ Connects to a 100BASE-FX device at full duplex.
- ◆ 8 100BASE-FX (SC) ports
- ◆ Fully compliant with IEEE 802.3u
- ◆ Supports Full-duplex operation only
- ◆ IEEE 802.3x-compliant Flow Control support

DES-6306 1000BASE-SX (SC) Gigabit Module

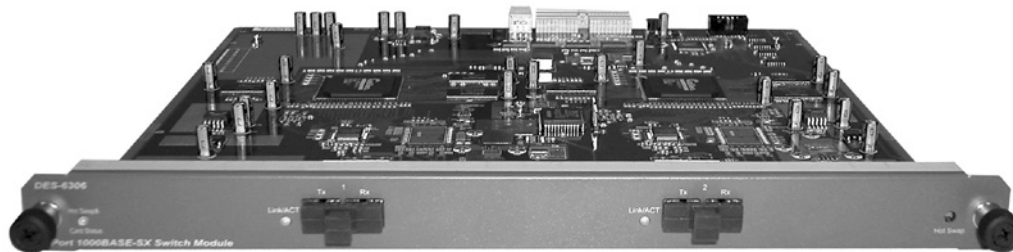

Figure 3-5. 2-port, 1000BASE-SX gigabit module

- ◆ 2-port, front-panel module
- ◆ Connects to 1000BASE-SX devices at full duplex.
- ◆ 2 1000BASE-SX (SC) Gigabit Ethernet ports
- ◆ Fully compliant with IEEE 802.3z
- ◆ Support Full-duplex operation only
- ◆ IEEE 802.3x-compliant Flow Control support

DES-6307 1000BASE-LX (SC) Gigabit Module

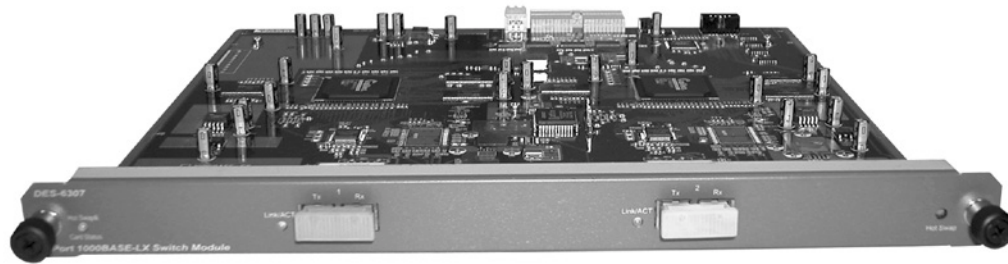

Figure 3-6. 2-port, 1000BASE-LX gigabit module

- ◆ 2-port, front-panel module
- ◆ Connects to 1000BASE-LX devices at full duplex
- ◆ 2 1000BASE-LX (SC) Gigabit Ethernet ports
- ◆ Fully compliant with IEEE 802.3z
- ◆ Supports full-duplex operation only
- ◆ IEEE 802.3x-compliant Flow Control support

DES-6308 1000BASE-T (RJ-45) Module

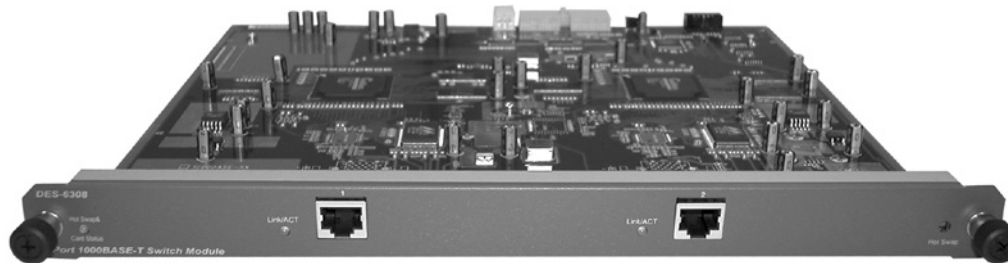

Figure 3-7. 2-port, 1000BASE-T (RJ-45) module

- ◆ 2-port, front-panel module
- ◆ Connects to 1000BASE-T devices only at full-duplex and auto-negotiating.
- ◆ 2 Auto-sensing 10/100/1000 Mbps Port
- ◆ Fully compliant with IEEE 802.3ab
- ◆ Fully compliant with IEEE 802.1Q/P
- ◆ Back pressure Flow Control support for Half-duplex mode
- ◆ IEEE 802.3x compliant Flow Control support for Full-duplex

DES-6309 GBIC Module

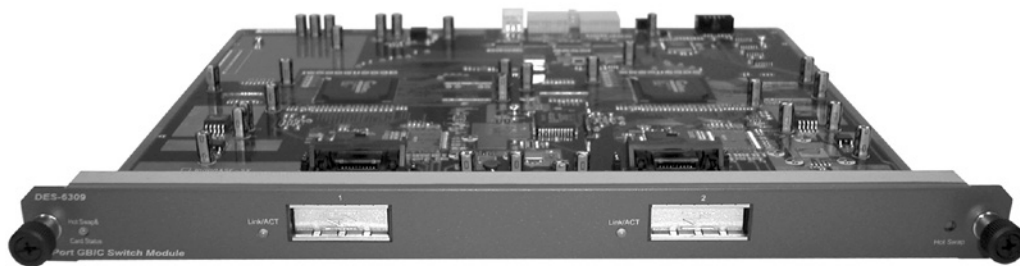

Figure 3-8. 2-port GBIC Module

- ◆ Two-port, front-panel module
- ◆ Connects to GBIC devices at full duplex
- ◆ 2 GBIC Ethernet ports
- ◆ Fully compliant with IEEE 802.3z
- ◆ Supports full-duplex operation only
- ◆ IEEE 802.3x-compliant Flow Control support

Power Supply Modules

- ◆ Dual power modules design with current sharing design
- ◆ Full redundant feature design to ensure continuous operation
- ◆ If one power module failed, the other will take over all current supply automatically.
- ◆ Hot-swappable/Hot-pluggable capability
- ◆ Power management functions
- ◆ Input: 90 ~ 264 VAC, 47 ~ 63Hz
- ◆ Output: 3.3V 80A Max, 12V 2A Max

LED Indicators

The LED indicators of the Switch include CPU Status and Power OK. The following shows the LED indicators for the Switch along with an explanation of each indicator.



Figure 3-9. CPU Front Panel LED Indicators

- ◆ **CPU Status** This center indicator on the front panel displays the current status of the switch. The LED will blink while the Power-On Self-Test (POST) is running during startup. It will light a steady green after the POST test to indicate the switch is powered on and operating properly. It will light amber when an error occurs during startup and the switch is therefore not functioning.
- ◆ **Power OK** This indicator lights green when the CPU module of the switch is receiving power and functioning properly.

CONNECTING THE SWITCH

This chapter describes how to connect the Switch to your Ethernet network as well as providing an informational cable length table.

Switch to End Node

End nodes include PCs outfitted with a Network Interface Card (NIC) and most routers. For twisted-pair (copper) connections, the RJ-45 UTP ports on NICs and most routers are MDI-II. When using a normal straight-through cable, an MDI-II port must connect to an MDI-X port.

An end node can be connected to the Switch via a two-pair Category 3, 4, 5 UTP/STP straight cable (be sure to use Category 5 UTP or STP cabling for 100BASE-TX Fast Ethernet connections). The end node should be connected to any of the sixteen ports (1x - 16x) on the 10BASE-T/100BASE-TX module. The LED indicators for the port the end node is connected to are lit according to the capabilities of the NIC. If LED indicators are not illuminated after making a proper connection, check the PC's LAN card, the cable, switch conditions, and connections.

The following LED indicator states are possible for an end node to switch connection:

1. The 100M indicator comes *ON* for a 100 Mbps and stays *OFF* for 10 Mbps.
2. The Link/Act indicator lights up upon hooking up a PC that is powered on.

Switch to Hub or Switch

These connections can be accomplished in a number of ways. For twisted-pair (copper) connections, the most important consideration is that when using a normal, straight-through cable, the connection should be made between a normal crossed port (Port 1x, 2x, etc.) and an Uplink (MDI-II) port. If you are using a crossover cable, the connection can be made from a normal crossed port to another crossed port.

- ◆ A 10BASE-T hub or switch can be connected to the Switch via a two-pair Category 3, 4 or 5 UTP/STP straight cable.
- ◆ A 100BASE-TX hub or switch can be connected to the Switch via a four-pair Category 5 UTP/STP straight cable.

If the other switch or hub contains an unused Uplink port, we suggest connecting the other device's Uplink (MDI-II) port to any of the switch's (MDI-X) ports (1x - 16x 100BASE-TX ports).

If the other device does not have an unused Uplink port, make the connection with a crossover cable from any of the twisted-pair ports on the switch to any normal twisted-pair port on the hub.

10BASE-T Device

For a 10BASE-T device, the Switch's LED indicators should display the following:

- ◆ 100M speed indicator is *OFF*.
- ◆ Link/Act indicator is *ON*.

100BASE-TX Device

For a 100BASE-TX device, the Switch's LED indicators should display the following:

- ◆ 100M speed indicator is *ON*.
- ◆ Link/Act indicator is *ON*.

1000BASE-T Device

For a 1000BASE-T device, the Switch's LED indicators should display the following:

- ◆ Link/Act indicator is *ON*.

100BASE-FX Device

For a 100BASE-FX device, the Switch's LED indicators should display the following:

- ◆ Link/Act indicator is *ON*.

1000BASE-SX Device

For a 1000BASE-SX device, the Switch's LED indicators should display the following:

- ◆ Link/Act indicator is *ON*.

1000BASE-LX Device

For a 1000BASE-LX device, the Switch's LED indicators should display the following:

- ◆ Link/Act indicator is *ON*.

Cable Lengths

Use this table to determine the maximum allowable distance for each cable media type.

Standard	Media Type	MHz/km	Maximum
-----------------	-------------------	---------------	----------------

		Rating	Distance
1000BASE-SX	50/125µm Multimode Fiber	400	500 Meters
	50/125µm Multimode Fiber	500	550 Meters
	62.5/125µm Multimode Fiber	160	220 Meters
	62.5/125µm Multimode Fiber	200	275 Meters
1000BASE-LX	50/125µm Multimode Fiber	400	500 Meters
	50/125µm Multimode Fiber	500	550 Meters
	62.5/125µm Multimode Fiber	500	550 Meters
	10µ Single-mode Fiber		5000 Meters
1000BASE-T	Category 5e UTP Cable (1000Mbps)		100 Meters
100BASE-FX	50/125µm Multimode Fiber (half-duplex operation)		400 Meters
	50/125µm Multimode Fiber (full-duplex operation)		2000 Meters
	62.5/125µm Multimode Fiber (half-duplex operation)		400 Meters
	52.5/125µm Multimode Fiber (full-duplex operation)		2000 Meters
100BASE-TX	Category 5 UTP Cable (100Mbps)		100 Meters
10BASE-T	Category 3 UTP Cable (10Mbps)		100 Meters

Table 4-1. Cable Lengths

TECHNICAL SPECIFICATIONS

General		
Standards	IEEE 802.3 10BASE-T Ethernet IEEE 802.3u 100BASE-TX Fast Ethernet IEEE 802.3z 1000BASE-SX/LX Gigabit Ethernet IEEE 802.1ab 1000BASE-T Gigabit Ethernet IEEE 802.1p/q IEEE 802.3x RFC 1123, RFC 2236 RFC1493, RFC 951 RFC2131, RFC1058 RFC1723, RFC 1389 RFC1253, RFC1583 RFC2178, RFCRFC 1850 RFC 1112, RFC 2236	
Management	MIB II, RMON, SNMP,	
Protocol	CSMA/CD	
Data Transfer Rate	Half-duplex	Full-Duplex
Ethernet	10 Mbps	20 Mbps
Fast Ethernet:	100 Mbps	200 Mbps
Gigabit Ethernet:	n/a	2000 Mbps
Topology	Star	
Network Cables	2-pair Category 3/4/5 UTP (max. 100 m) EIA/TIA-568 100-ohm STP (max. 100 m)	
10BASE-T:	2-pair Category 5 UTP (max. 100 m) EIA/TIA-568 100-ohm STP (max. 100 m)	
100BASE-TX:	2-pair Category 5 UTP (max. 100 m) EIA/TIA-568 100-ohm STP (max. 100 m)	
1000BASE-T	EIA/TIA-568 100-ohm STP (max. 100 m)	

Physical and Environmental	
AC Input	90 to 264 VAC, 47-63 Hz (auto-adjusting internal power supply)
AC Output	3.3V, 80A Max
DC Fans	Two built-in 60 x 60 mm fans per power supply unit
Temperature	Operating: 0° to 40° C (32° to 104° F) Storage: -25° to 55° C (-13° to 131° F)
Relative Humidity	Operating: 5% to 95% (non-condensing) Storage: 0% to 95% (non-condensing)
Dimensions	H: 35.6 cm (14.01 in.) W: 44.0 cm (17.32 in.) D: 29.4 cm (11.57 in.)
EMI	FCC Class A, CE Class A, VCCI Class A, BSMI Class A, C-Tick Class A
Safety	UL/CUL, TUV, CE

RJ-45 PIN SPECIFICATION

When connecting the Switch to another switch, a bridge or a hub, a modified crossover cable is necessary. Please review these products for matching cable pin assignment.

The following diagram and table show the standard RJ-45 receptacle/connector and their pin assignments for the switch-to-network adapter card connection, and the straight/crossover cable for the Switch-to-switch/hub/bridge connection.

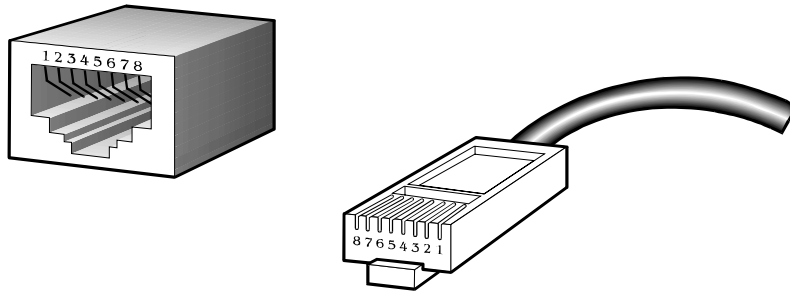

Figure B-1. The standard RJ-45 receptacle/connector

RJ-45 Connector pin assignment	
Contact	Media Direct Interface Signal
1	Tx + (transmit)
2	Tx - (transmit)
3	Rx + (receive)
4	Not used
5	Not used
6	Rx - (receive)
7	Not used
8	Not used

Table B-1. The standard Category 3 cable, RJ-45 pin assignment

The following shows straight cable and crossover cable connection:

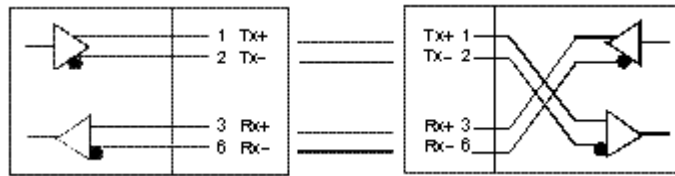

Figure B-2. Straight cable for Switch (uplink MDI-II port) to switch/Hub or other devices connection

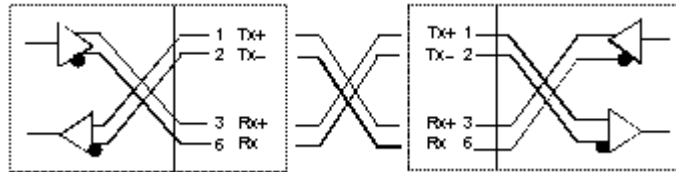

Figure B-3. Crossover cable for Switch (MDI-X port) to switch/hub or other network devices (MDI-X port) connection.