



Hardware Installation Guide

Product Model: DXS-3600 Series

Layer 2/3 Managed 10GbE Switch

Release 2.40

Information in this document is subject to change without notice. Reproduction in any manner whatsoever, without the written permission of D-Link Corporation, is strictly forbidden.

Trademarks used in this text: D-Link and the D-LINK logo are trademarks of D-Link Corporation; Microsoft and Windows are registered trademarks of Microsoft Corporation.

Other trademarks and trade names may be used in this document to refer to either the entities claiming the marks and names or their products. D-Link Corporation disclaims any proprietary interest in trademarks and trade names other than its own.

© 2015 D-Link Corporation. All rights reserved.

March, 2015 P/N 651GS1510015G

FCC Warning

This equipment has been tested and found to comply with the limits for a Class A digital device, pursuant to Part 15 of the FCC Rules. These limits are designed to provide reasonable protection against harmful interference when the equipment is operated in a commercial environment. This equipment generates, uses, and can radiate radio frequency energy and, if not installed and used in accordance with this manual, may cause harmful interference to radio communications. Operation of this equipment in a residential area is likely to cause harmful interference in which case the user will be required to correct the interference at his expense.

CE Mark Warning

This is a Class A product. In a domestic environment, this product may cause radio interference in which case the user may be required to take adequate measures.

Warnung

Dies ist ein Produkt der Klasse A. Im Wohnbereich kann dieses Produkt Funkstörungen verursachen. In diesem Fall kann vom Benutzer verlangt werden, angemessene Massnahmen zu ergreifen.

Precaución!

Este es un producto de Clase A. En un entorno doméstico, puede causar interferencias de radio, en cuyo caso, puede requerirse al usuario para que adopte las medidas adecuadas.

Attention!

Ceci est un produit de classe A. Dans un environnement domestique, ce produit pourrait causer des interférences radio, auquel cas l'utilisateur devrait prendre les mesures adéquates.

Attenzione!

Il presente prodotto appartiene alla classe A. Se utilizzato in ambiente domestico il prodotto può causare interferenze radio, nel cui caso è possibile che l'utente debba assumere provvedimenti adeguati.

VCCI Warning

この装置は、クラス A 情報技術装置です。この装置を家庭環境で使用すると電波妨害を引き起こすことがあります。この場合には使用者が適切な対策を講ずるよう要求されることがあります。VCCI-A.

Intended Readers

The **DXS-3600 Series Hardware Installation Guide** contains detailed information about the hardware specifications of a switch in this series. It also contains brief information on how to configure and manage a switch in this series. This manual is intended for advanced level users that are familiar with network management concepts and terminology. For all practical reasons the **DXS-3600-32S** and **DXS-3600-16S** will simply be referred to as the **switch** throughout this manual.

Typographical Conventions

Convention	Description
[]	This convention is generally used in CLI commands. Square brackets indicate an optional entry. For example: [copy paste] means that optionally you can type copy or you can type paste. Do not type the brackets.
Bold Font	This font is generally used to put emphasis on a key subject in a sentence throughout this manual. This font is also used to represent the physical CLI command used when explaining a topic.
<i>Courier New Font</i>	This font is used to indicate CLI command examples used in this document.
Initial capital letter	The use of initial capital letters indicates that a referral to a specific name was made. This will be seen a lot when referring to protocols, standards, keyboard keys, and when we refer to the 'Switch' as a generic name for all switches with in the series. For example: Click Enter.
Menu Name > Menu Option	This convention indicates the referral to a menu structure found in the Web User Interface of this Switch. For example: Device > Port > Port Properties means the Port Properties menu option under the Port menu option that is located under the Device menu.

Notes, Notices, and Cautions



NOTE: A note indicates important information that helps you make better use of your device.



NOTICE: A notice indicates either potential damage to hardware or loss of data and tells you how to avoid the problem.



CAUTION: A caution indicates a potential for property damage, personal injury, or death.

Safety Instructions

Please pay careful attention to the following safety guidelines to ensure your own personal safety and to help protect your system from potential damage.

Safety Cautions

To greatly reduce the risk of physical injury, electrical shock, fire, and damage to equipment, observe the following precautions.

Observe and follow service markings.

- Do not attempt to service any product, except when it is explained in the system's documentation.
- Opening or removing covers that are marked with this () symbol may expose the user to electrical shock.
- Only a trained service technician should service components inside these compartments.

If any of the following conditions occur, unplug the product from the electrical outlet and replace the part or contact your trained service provider:

- Damage to the power cable, extension cable, or plug.
- An object has fallen into the product.
- The product has been exposed to water.
- The product has been dropped or damaged.
- The product does not operate correctly when the operating instructions are correctly followed.

General safety cautions:

- Keep the system away from radiators and heat sources. Also, do not block cooling vents.
- Do not spill food or liquids on system components, and never operate the product in a wet environment. If the system gets wet contact your trained service provider.
- Do not push any objects into the openings of the system. Doing so can cause fire or electric shock by shorting out interior components.
- Only use this product with approved equipment.
- Allow the product to cool before removing the cover or touching internal components.
- Operate the product only from the type of external power source indicated on the electrical ratings label. If unsure of the type of power source required, consult your service provider or local power company.
- Be sure that attached devices are electrically rated to operate with the power available in your location.
- Use only approved power cable(s). If you have not been provided with a power cable for your system or for any AC-powered option intended for your system, purchase a power cable that is approved for use in your country. The power cable must be rated for the product and for the voltage and current marked on the product's electrical ratings label. The voltage and current rating of the cable should be greater than the ratings marked on the product.
- To help prevent electric shock, plug the system and peripheral power cables into properly grounded electrical outlets. These cables are equipped with three-prong plugs to help ensure proper grounding. Do not use adapter plugs or remove the grounding prong from a cable. If using an extension cable is necessary, use a 3-wire cable with properly grounded plugs.
- Observe the extension cable and power strip ratings. Make sure that the total ampere rating of all products plugged into the extension cable or power strip does not exceed 80 percent of the ampere ratings limit for the extension cable or power strip.
- To help protect the system from sudden, transient increases and decreases in electrical power, use a surge suppressor, line conditioner, or uninterruptible power supply (UPS).
- Position system cables and power cables carefully. Route cables so that they cannot be stepped on or tripped over. Be sure that nothing rests on any cables.
- Do not modify power cables or plugs. Consult a licensed electrician or your power company for site modifications. Always follow your local or national wiring rules.

When connecting or disconnecting power to and from hot-pluggable power supplies, observe the following guidelines:

- Install the power supply before connecting the power cable to the power supply.
- Unplug the power cable before removing the power supply.
- If the system has multiple sources of power, disconnect power from the system by unplugging all power cables from the power supplies.
- Move products with care and ensure that all casters and stabilizers are firmly connected to the system. Avoid sudden stops and uneven surfaces.

To help avoid damage to the system, be sure that the voltage selection switch, on the power supply, is set to match the power available at the switch's location:

- 115V/60Hz is used mostly in North and South America as well as Far Eastern countries like as South Korea and Taiwan

- 100V/50Hz is used mostly in Eastern Japan and 100V/60Hz in Western Japan
- 230V/50Hz is used mostly in Europe, the Middle East, Africa and the Far East

General Precautions for Rack-Mountable Products

Please pay careful attention to the following precautions concerning rack stability and safety. Systems are considered to be components in a rack. Thus, a component refers to any system, as well as to various peripherals or supporting hardware:



CAUTION: Installing systems in a rack without the front and side stabilizers installed could cause the rack to tip over, potentially resulting in bodily injury under certain circumstances. Therefore, always install the stabilizers before installing components in the rack. After installing system/components in a rack, never pull more than one component out of the rack on its slide assemblies at one time. The weight of more than one extended component could cause the rack to tip over and may result in serious injury.

- Before working on the rack, make sure that the stabilizers are secured to the rack, extended to the floor, and that the full weight of the rack rests on the floor. Install front and side stabilizers on a single rack or front stabilizers for joined multiple racks before working on the rack.
- Always load the rack from the bottom up, and load the heaviest item in the rack first.
- Make sure that the rack is level and stable before extending a component from the rack.
- Use caution when pressing the component rail release latches and sliding a component into or out of a rack; the slide rails can pinch your fingers.
- After a component is inserted into the rack, carefully extend the rail into a locking position, and then slide the component into the rack.
- Do not overload the AC supply branch circuit that provides power to the rack. The total rack load should not exceed 80 percent of the branch circuit rating.
- Ensure that proper airflow is provided to components in the rack.
- Do not step on or stand on any component when servicing other components in a rack.



CAUTION: Never defeat the ground conductor or operate the equipment in the absence of a suitably installed ground conductor. Contact the appropriate electrical inspection authority or an electrician if uncertain that suitable grounding is available.



CAUTION: The system chassis must be positively grounded to the rack cabinet frame. Do not attempt to connect power to the system until grounding cables are connected. Completed power and safety ground wiring must be inspected by a qualified electrical inspector. An energy hazard will exist if the safety ground cable is omitted or disconnected.

Protecting Against Electrostatic Discharge

Static electricity can harm delicate components inside the system. To prevent static damage, discharge static electricity from your body before touching any of the electronic components, such as the microprocessor. This can be done by periodically touching an unpainted metal surface on the chassis.

The following steps can also be taken prevent damage from electrostatic discharge (ESD):

- When unpacking a static-sensitive component from its shipping carton, do not remove the component from the antistatic packing material until ready to install the component in the system. Just before unwrapping the antistatic packaging, be sure to discharge static electricity from your body.
- When transporting a sensitive component, first place it in an antistatic container or packaging.
- Handle all sensitive components in a static-safe area. If possible, use antistatic floor pads, workbench pads and an antistatic grounding strap.

Table of Contents

Intended Readers	3
Typographical Conventions	3
Notes, Notices, and Cautions	3
Safety Instructions	3
Safety Cautions	4
General Precautions for Rack-Mountable Products	5
Protecting Against Electrostatic Discharge	5
Introduction	7
Switch Description	7
Package Contents	7
Features	8
Front Panel Components	9
LED Indicators	10
Rear Panel Description	12
Power Supply Module	12
Fan Module	12
Side Panel Description	13
Installation	14
Installation Guidelines	14
Installing the Switch without a Rack	14
Installing the Switch into a Rack	15
Installing Transceivers into the Transceiver Ports	15
Installing Power Modules into the Power Module Ports	16
Installing an AC Power Module	16
Installing a DC Power Module	17
Installing Fan Modules into the Fan Module Ports	18
Switch Connections	20
Switch to End Node	20
Switch to another Switch	20
Switch Stacking	21
Switch to a Server	23
Switch Management	24
Management Options	24
Connecting to the Console Port	24
Connecting to the Switch for the First Time	26
Creating a User Account	26
Configuring the IP Address	27
Connecting using SNMP	27
Traps	29
Management Information Base (MIB)	29
Connecting using the Web User Interface	29
Logging onto the Web Manager	30
Areas of the User Interface	30
Appendix A - Technical Specifications	32
Appendix B - Cables and Connectors	38
Ethernet Cable	38
Console Cable	38
Warranty & Technical Support	40

Introduction

Switch Description

Package Contents

Features

Front Panel Components

Rear Panel

Side Panel Description

Switch Description

The **DXS-3600 Series** switch is a switch designed to meet the needs and requirements Data Center networks that require Top-of-Rack access switches and Enterprise/Campus aggregation switches, where low latency and high bandwidth capacity is essential. The switch is a fully managed Layer 2, for Standard Image (SI) mode, and Layer 3, for Enhanced Image (EI) mode, switch. With support for IPv4 static and dynamic routing and a plethora of advanced security and enhanced QoS features, the switch future proofs your network and provides a seamless migration path to IPv6.

The DXS-3600 Series, running in the Enhanced Image (EI) mode, is a high-performance Layer 3 switch that provides advanced Layer 3 routing features such as RIP, OSPF, BGP4, VRRP, up to 5 IP addresses per VLAN, and floating static routes. Multipath routing (which is the method of establishing multiple paths between given source-destination nodes within a network) are also features supported on the switch. These added routing features provide redundancy, load balancing, and improved network utilization for the network.

The DXS-3600 Series incorporates an advanced portfolio of security features designed to protect your network from malicious attacks. SSH encrypted management guarantee secure private configuration and monitoring when using the Graphical User Interface (GUI) and Command Line (CLI). IEEE 802.1X ports and MAC-based authentication help provide added network security by requiring all users attempting to connect to your network to provide a username and password. This username and password must then be authenticated on a RADIUS or TACACS+ server, ensuring only authorized users have access to the network. Access Control Lists (ACL) based on Layers 2/3/4, Rate Limiting, and Guest VLANs provide even more control over what and how users access the network.

The DXS-3600 Series facilitates the deployment of enterprise applications such as VoIP, streaming media, and multicast content delivery such as IP video conferencing and software deployment with enhanced enterprise features such as L2/L3/L4 QoS, IGMP and MLD snooping, 802.1w Rapid Spanning Tree, 802.1s Multiple Spanning Tree group, 802.3ad Link Aggregation, and 802.1Q VLANs.

In the DXS-3600 Series the following switches exist:

- **DXS-3600-16S** - which includes eight 10 Gigabit SFP+ ports and one open expansion module slot.
- **DXS-3600-32S** - which includes twenty-four 10 Gigabit SFP+ ports and one open expansion module slot.

Package Contents

Open the shipping carton of the Switch and carefully unpack its contents. The carton should contain the following items:

- One DXS-3600 Series switch.
- One Quick Installation Guide.
- One AC power cord.
- One AC power supply module.
- Three Fan modules.
- One RJ-45 to RS-232 console cable.
- One rack mounting kit (two brackets and screws).
- Four rubber feet with adhesive backing.
- One CD containing the Web UI Reference Guide, CLI Reference Guide, and D-View module.

If any item is missing or damaged, please contact your local D-Link reseller for replacement.

Features

This switch is action packed with an abundance of networking features that span inside and outside of the traditional Layer 3 framework. The list below highlights the significant protocols and features supported by this switch.

Features that can be found on this switch are:

- D-Link License Management System (DLMS)
- Jumbo Frames (12 KBytes)
- Port Mirroring
- Priority-based Flow Control (PFC)
- IGMP Snooping (Versions 1, 2, 3)
- Secure Shell (SSH)
- Port-based VLAN
- VLAN Trunking
- Subnet-based VLAN
- VLAN Translation
- Queue Handling
- Bandwidth Control
- Congestion Control
- Time Based ACL
- Port Security
- BPDU Attack Protection
- 802.1X Network Access Control
- Guest VLAN
- RADIUS Accounting
- Link Layer Discovery Protocol (LLDP)
- Web-based Graphical User Interface (Web GUI)
- Traffic Monitoring
- TFTP Client
- Simple Network Management Protocol (SNMP)
- DHCP Server and Client
- DHCP Relay
- Multiple Image and Configuration
- Password Recovery and Encryption
- Debug Command
- DNS Resolver and Relay
- Routing Information Protocol (RIP)
- Border Gateway Protocol (BGP)
- Route Preference and Distribution
- Multicast Duplication
- Distance Vector Multicast Routing Protocol (DVMRP)
- IP Interface
- Spanning Tree Protocol (STP, RSTP, MSTP)
- Link Aggregation
- Layer 2 Multicast Filtering
- IGMP and MLD Proxy
- 802.1Q VLAN
- MAC-based VLAN
- Private VLAN
- Q-in-Q
- Quality of Service (QoS)
- Class of Service (CoS)
- Three Color Marker
- Access Control List (ACL)
- Traffic Segmentation
- Broadcast/Multicast/DLF Storm Control
- DoS Prevention
- Access Authentication Control (AAA)
- User Account Privilege for Management Access
- Address Resolution Protocol (ARP)
- Static Routing
- Command Line Interface (CLI)
- Telnet Server and Client
- FTP Client
- System Log
- CPU Monitoring
- Trap/ Log Severity Control
- Flash File System (FFS)
- Simple Network Time Protocol (SNTP)
- Traceroute and Ping
- Virtual Router Redundancy Protocol (VRRP)
- Open Shortest Path First (OSPF)
- Multicast Listener Discovery (MLD)
- Internet Group Management Protocol (IGMP)
- Protocol Independent Multicast (DM, SM, SSM, Sparse-Dense)
- Management Information Base (MIBs) for MIBII, Bridge MIB, SNMPv2 MIB, RMON MIB, RMONv2 MIB, Ether-like MIB, 802.3 MAU MIB, 802.1p MIB, IF MIB, RADIUS Authentication Client MIB, IGMPv3 MIB, RIPv2 MIB, IP Forwarding Table MIB (CIDR), IPv4 Multicast Routing MIB, PIM MIB for IPv4, RADIUS Accounting Client MIB, Ping MIB, Trace out

MIB, OSPFv2 MIB, VRRP MIB, Private MIB,

Entity MIB.

Front Panel Components

The front panel of the switch consists of LED indicators, an SD card slot, an Out-Of-Band Management port (MGMT), a Console port, SFP+ ports and an open module slot.



Figure 1-1 Front panel view of the DXS-3600-16S

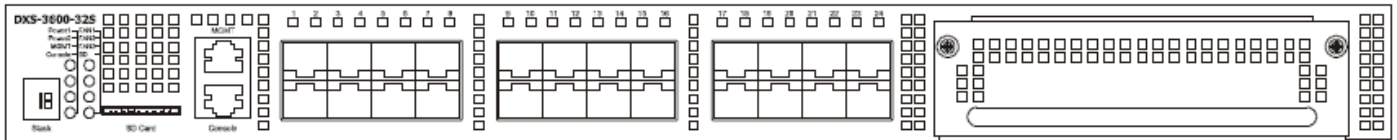

Figure 1-2 Front panel view of the DXS-3600-32S

Ports that can be found on the front panel of this switch are listed in the table below.

Port	Description
SD Card Slot	This port can be used to insert an external SD memory card. The maximum capacity SD card that can be inserted into this port is 32Gb.
Management port (MGMT)	This port is a 10/100/1000Mbps Ethernet port with an RJ-45 connection. This Out-Of-Band management port that can be used to configure this switch without being connected to the network.
Console port	This port is an RJ-45 connection port that can be used to connect to the Command Line Interface (CLI) of this switch for configuration, management and monitoring. This port uses a special console cable (included with the packing) with a DB9 interface to connect the Switch to a PC's COM port.
10 Gigabit ports	This switch is equipped with SFP/SFP+/WDM ports. These ports can operate at 10Gbps speeds and support a vast collection of SFP/SFP+/WDM transceivers.
Expansion Module Slot	<p>This slot can be equipped with 4 kinds of additional modules. These modules are not included and should be bought separately.</p> <ul style="list-style-type: none"> • DXS-3600-EM-4XT (Four 10GBASE-T Copper ports). • DXS-3600-EM-8T (Eight 1000BASE-T Copper ports). • DXS-3600-EM-4QXS (Four 40Gbps QSFP+ transceiver slots). • DXS-3600-EM-8XS (Eight 10Gbps SFP+ transceiver slots). • DXS-3600-EM-Stack (Two 120Gbps CXP Stacking ports). This module can only be used with the DXS-3600-32S

For a complete list of SFP/SFP+/WDM/QSFP+ transceivers, that are compatible with this switch, refer to the “**Product Specifications**” section in **Appendix A - Technical Specifications**

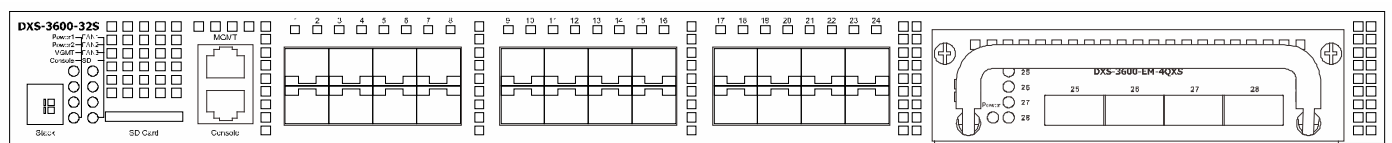

Figure 1-3 Front panel view of the DXS-3600-32S with EM-4XT module

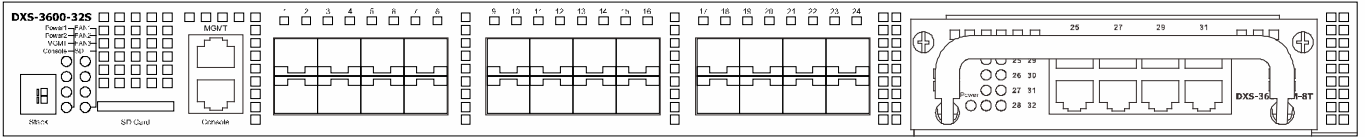

Figure 1-4 Front panel view of the DXS-3600-32S with EM-8T module

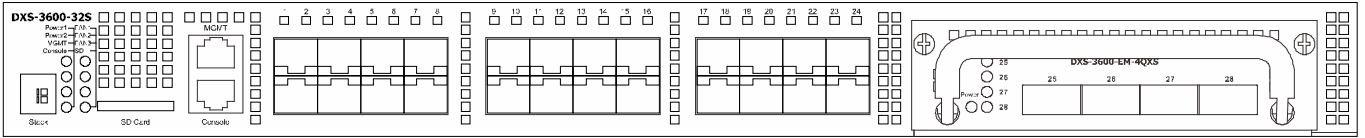

Figure 1-5 Front panel view of the DXS-3600-32S with EM-4QXS module

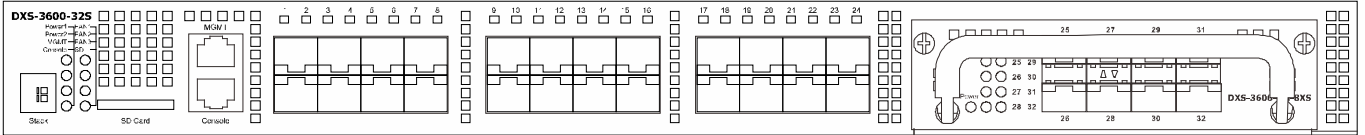

Figure 1-6 Front panel view of the DXS-3600-32S with EM-8XS module

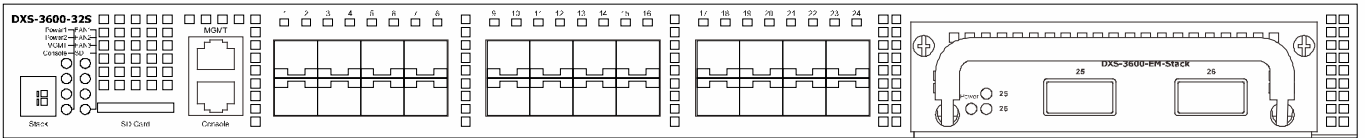

Figure 1-7 Front panel view of the DXS-3600-32S with EM-Stack module

LED Indicators

Located on the front panel of the switch are LED indicators: Power1, Power2, MGMT, Console, Fan1, Fan2, Fan3, and SD. Additionally, the **DXS-3600-32S** also has a Seven segment stacking ID LED. For each SFP+ port there is a Link/Act light.

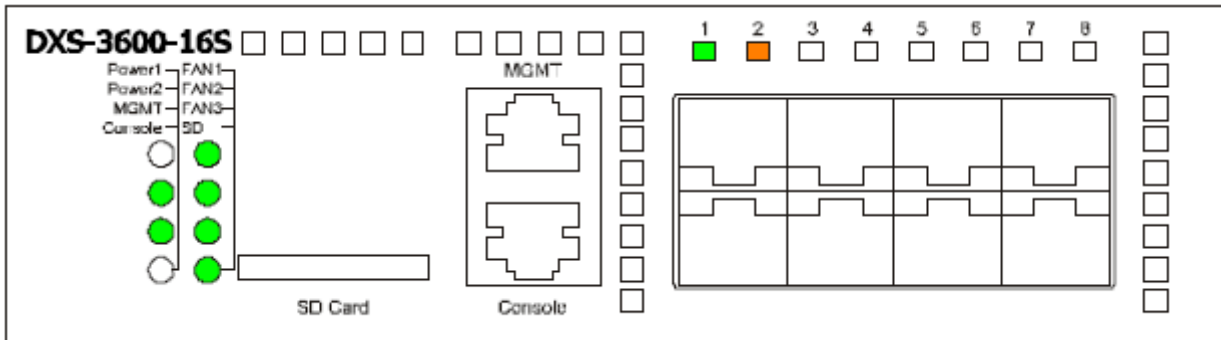

Figure 1-8 LED indicators for the DXS-3600-16S

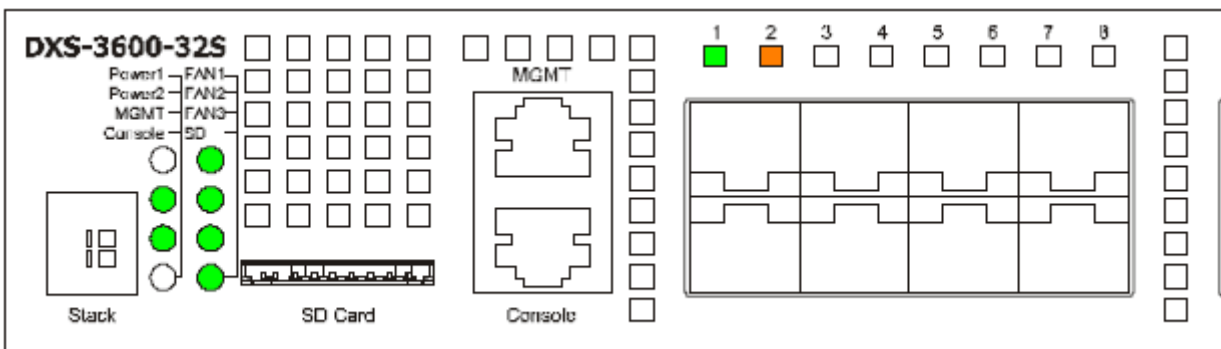

Figure 1-9 LED indicators for the DXS-3600-32S

LED	Description
Power 1, Power 2	<p>This LED will light solid green after the Switch has been powered on successfully.</p> <p>This LED will light solid orange if the Switch's power supply fails.</p> <p>This LED will be off when the Switch is no longer receiving power (i.e. powered off).</p>
Management (MGMT)	<p>This LED will light solid green after a link to the management port was successfully established.</p> <p>This LED will blink when activity on this port is taking place.</p> <p>This LED will be off when there is no link present or when this interface was shutdown from within the switch's configuration.</p>
Console	<p>This LED will blink green during the Power-On Self Test (POST).</p> <p>This LED will light solid green when a user is logged in through the console port.</p> <p>This LED will be off after the POST finished successfully and no user is connected to the console port.</p>
Fan1, Fan2, Fan3	<p>This LED will light solid green when the fan is operating normally.</p> <p>This LED will light solid orange when the switch is booting up or when a diagnostics test is taking place.</p> <p>This LED will blink orange when a fan fails.</p> <p>This LED will be off when the fan is not receiving power.</p>
SD	<p>This LED will light solid green if a Secure Digital (SD) card is plugged in.</p> <p>This LED will blink green when the Switch is reading or writing data to and from the SD card.</p> <p>This LED will be off when no SD card is plugged into the SD port.</p> <p>This LED will light solid red when an SD card failure has been detected.</p>
Link/Act LEDs	<p>This LED will light solid green when there is a secure connection to a 10Gbps Ethernet device at any of the ports.</p> <p>This LED will light solid orange when there is a secure connection to a 1Gbps Ethernet device at any of the ports.</p> <p>This LED will blink green when a 10Gbps port is active, or blink orange when a 1Gbps port is active.</p> <p>This LED will be off when there is no link or activity.</p>
Stacking ID	<p>This 7-segment LED can display numbers from 1 to 4 and the following letters H, h, E, and G. The stacking ID (1 to 4) can be assigned manually by the user or automatically by the system.</p> <p>The letter 'H' will be displayed if this switch is the master switch in the stack.</p> <p>The letter 'h' will be displayed if this switch is the backup master switch in the stack.</p> <p>The letter 'E' will be displayed if there was an error in the system's self-test.</p> <p>The letter 'G' will be displayed when the Safeguard engine entered the exhausted mode.</p>

Please refer to the "LED Indicators" section in the **Appendix A - Technical Specifications** for more LED information.

Rear Panel Description

Located on the rear panel of the switch are **two power supply module slots** and **three fan module slots**. **One power supply module** and **three fan modules** are included in the package for this switch. Any additional power supply module or fan module needs to be bought separately. This switch also supports the use of a DC power supply module.

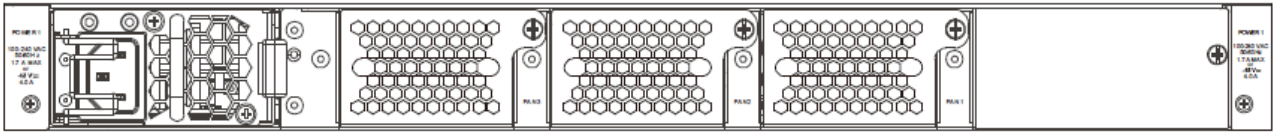

Figure 1-10 Rear panel view of the DXS-3600-16S

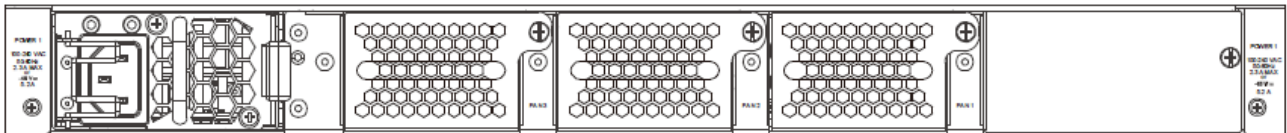

Figure 1-11 Rear panel view of the DXS-3600-32S

Ports that can be found on the rear panel of this switch are listed in the table below.

Port	Description
Two Power Supply Module Slots	<p>These slots can be equipped with 3 kinds of additional modules. Only one power supply module is included. Any additional modules should be bought separately.</p> <ul style="list-style-type: none"> • DXS-3600-PWR-FB (300W AC power supply tray with front-to-back airflow) • DXS-3600-PWR-BF (300W AC power supply tray with back-to-front airflow) • DXS-3600-PWRDC-FB (300W DC power supply tray with front-to-back airflow)
Three Fan Module Slots	<p>These slots can be equipped with 2 kinds of additional modules.</p> <ul style="list-style-type: none"> • DXS-3600-FAN-FB (Normal fan tray with front-to-back airflow) • DXS-3600-FAN-BF (Normal fan tray with back-to-front airflow)

Power Supply Module

Connect the one end of the AC power cord supplied to the AC power connector and the other end into a properly grounded electrical outlet. The switch will automatically adjust the power setting to adapt to any voltage supply in the range from 100~240VAC at 50~60Hz.

In addition, an optional second power supply module can be plugged into the second power supply connector slot displayed above. When the primary power connection fails, the secondary power connection will take over all the power immediately and automatically. The primary and secondary power supply can be either AC supplied or DC supplied, depending on the power supply module inserted. This makes it dual redundant.

The power supply modules are hot-swappable, meaning, that they can be inserted and removed while the switch is powered on. This feature enhances the reliability, offers load-sharing, and enhances the reliability and capacity of this switch. However, in the event that a power failure might occur in the environment and no UPS is used, as a precaution, unplug the power cord from the switch. After the return of power, you can plug the power cord back into the Switch's power connector.

Fan Module

The fan modules on this switch can provide **front-to-back** or **back-to-front** airflow depending on type on fan module installed. Another unique smart fan feature is that fans are capable to **automatically adjust their speed** depending on the IC sensor reading of the temperature required. This feature is so sensitive that it can even **adjust the speed of the fan** to accurately control the internal temperature.

Side Panel Description

Located on the side panels of the switch are **heat and fan vents** that are used to dissipate heat. Do not block these openings. Leave at least 4 inches of space at the rear and sides of the switch for proper ventilation. Be reminded that without proper heat dissipation and air circulation, system components might overheat, which could lead to system failure or even severely damage components.

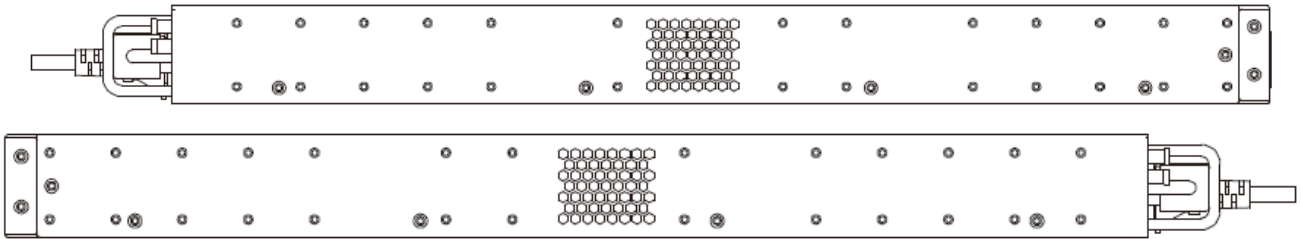

Figure 1-12 Side panels of the DXS-3600-16S

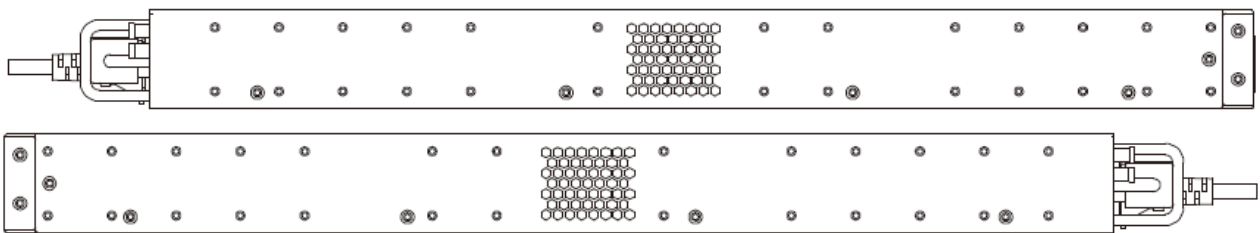

Figure 1-13 Side panels of the DXS-3600-32S

Installation

Installation Guidelines

Installing the Switch without a Rack

Installing the Switch into a Rack

Installing Transceivers into the Transceiver Ports

Installing Power Modules into the Power Module Ports

Installing Fan Modules into the Fan Module Ports

Installation Guidelines

This section will discuss the hardware installation guidelines that the user must follow in order to properly and safely install this switch into the appropriate environment.

- Visually inspect the power cord and see that it is fully secured to both the power connector, on the switch, and the electrical outlet, that supplies power.
- Install the switch in a fairly cool and dry place within the acceptable temperature and humidity operating ranges.
- Install the switch in a site free from strong electromagnetic field generators such as motors, vibration, dust, and direct exposure to sunlight.

Installing the Switch without a Rack

This section is used to guide the user through installing the switch in an area other than a switch rack. Attach the rubber feet included to the bottom of the switch. Take note that there should be marked blocks on the bottom of the switch to indicate where to attach the rubber feet. These marking are usually found at each bottom corner of the device. The rubber feet cushion the switch, protecting the casing from scratches and preventing it from scratching other surfaces.

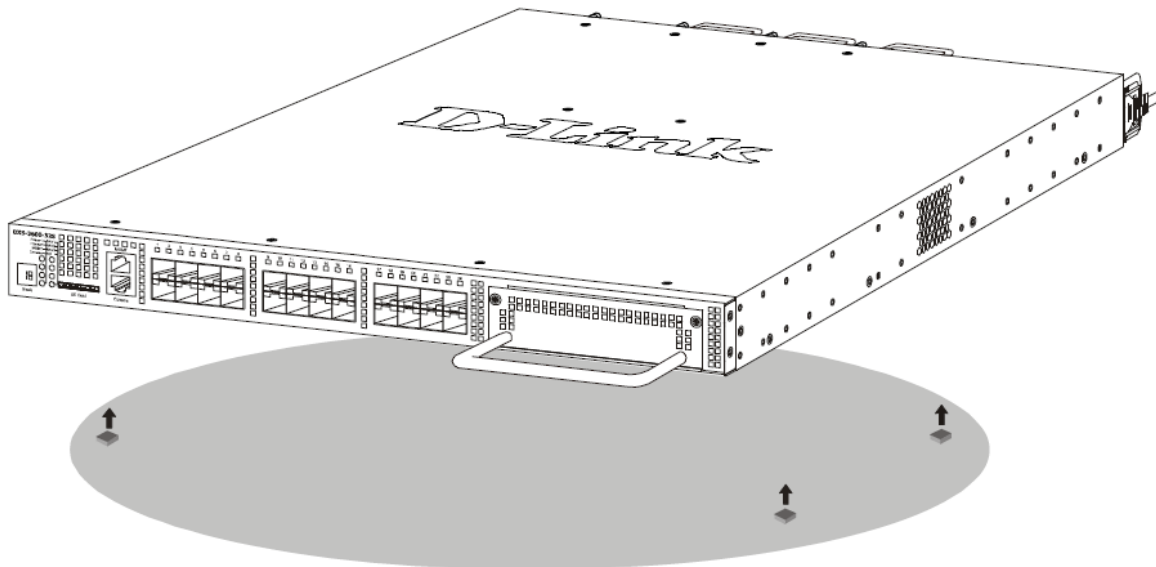

Figure 2-1 Prepare the Switch for installation on a desktop or shelf

Install the switch on a sturdy, level surface that can support the weight of the switch (see the Appendix section for the **Weight** specifications of this switch). Do not place any heavy objects on the switch. The power outlet should be within 1.82 meters (6 feet) of the switch. Make sure that there is proper heat dissipation from and adequate ventilation around the switch. Leave at least 10 cm (4 inches) of space at the front and rear of the switch for ventilation.

Installing the Switch into a Rack

This section is used to guide the user through installing the switch into a switch rack. The switch can be mounted in a standard 19"(1U) rack using the provided mounting brackets. Use the following diagram as a guide.

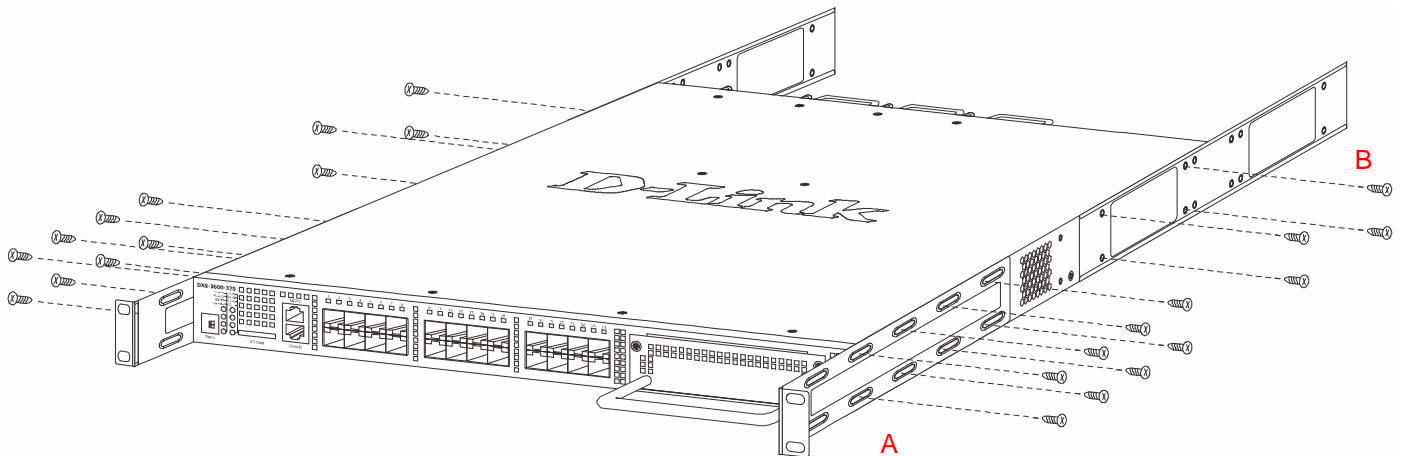

Figure 2-2 Fasten mounting brackets on the Switch

How to install the mounting brackets onto the switch (Figure above) and onto the rack (Figure below):

1. Fasten the mounting brackets **A** and **B** to the sides of the switch using the screws provided, as seen in the figure above.
2. Fasten the mounting bracket **C** in the appropriate open space in the rack using the screws provided, as seen in the figure below.
3. Simply slide the switch (fastened bracket **B** into fastened bracket **C**) into the rack.
4. Lastly, fasten mounting bracket **A** to the rack using the screws provided.

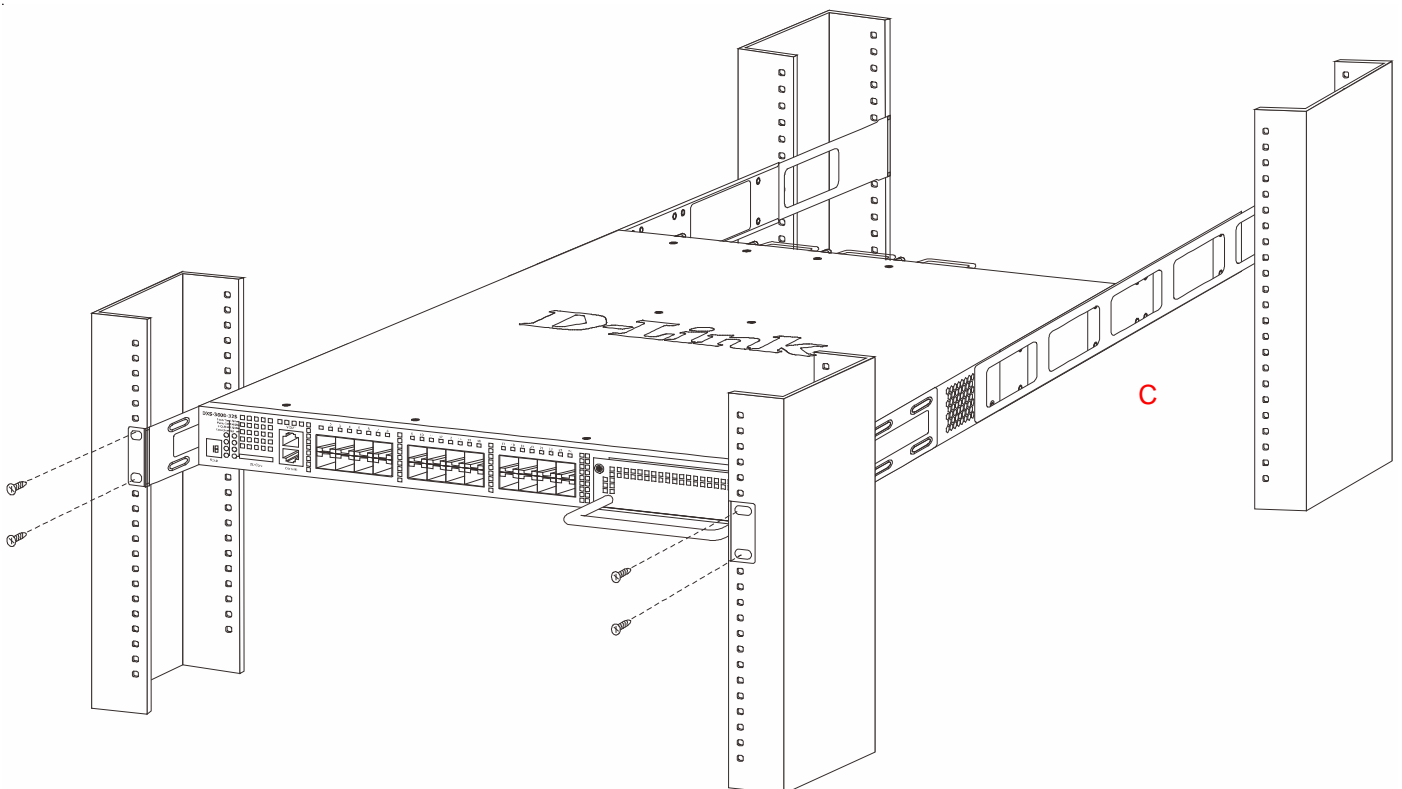

Figure 2-3 Installing the Switch in a rack

Make sure that there is adequate space around the Switch to allow for proper air flow, ventilation, and cooling.

Installing Transceivers into the Transceiver Ports

The switch is equipped with small form-factor pluggable plus (SFP+) ports that can be used to connect various other networking devices to this switch that do not support the standard copper wiring connection. These ports are generally used to connect this switch to networking devices that can only be accessed via an optical fiber connection and is

normally used for a connection that spans greater distances. The maximum distance that the copper wiring connection can reach is 100 meters. Fiber optic connections can span over several kilometers.

The figure below illustrates how to properly insert SFP+ transceivers into the switch's SFP+ ports.

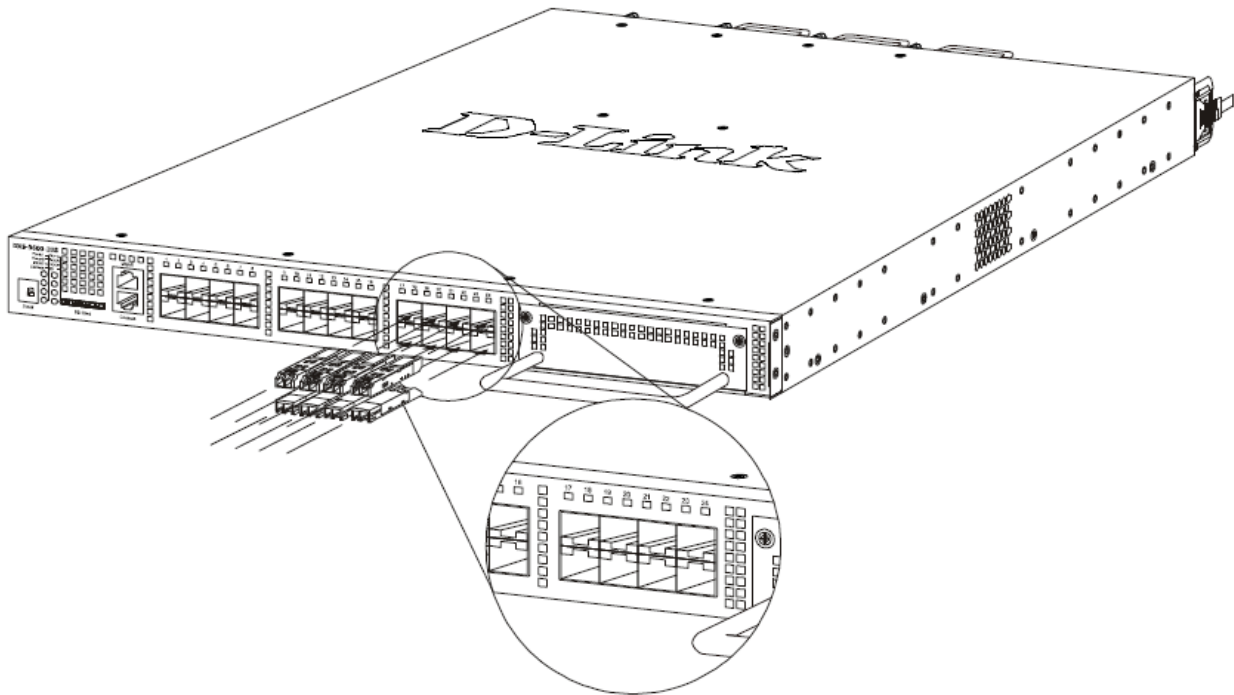

Figure 2-4 Inserting SFP transceivers into the Switch's SFP ports

The SFP+ ports also support other transceiver form factors like **SFP**, **SFP+**, and **WDM** transceivers. A complete list of SFP/SFP+/WDM transceivers, compatible with this switch, can be found in the "Appendix A - Technical Specifications" section in Appendix A, at the end of this document.

Installing Power Modules into the Power Module Ports

The power module slots, located on the rear panel of this switch, support two types of power supply modules.

AC Power Supply Module:

- **DXS-3600-PWR-FB:** A 300W AC power supply tray with front-to-back airflow.
- **DXS-3600-PWR-BF:** A 300W AC power supply tray with back-to-front airflow.

DC Power Supply Module:

- **DXS-3600-PWRDC-FB:** A 300W DC power supply tray with front-to-back airflow.



NOTE: The Power Modules all support a specific airflow direction. This air-flow direction must be the **same** as the Fan Module installed. **By default** the airflow direction of the Power Module and Fan Module installed is **front-to-back**.

Installing an AC Power Module

Connect the one end of the AC power cord supplied to the AC power connector and the other end into a properly grounded electrical outlet. The switch will automatically adjust the AC power setting to adapt to any voltage supply in the range from 100~240VAC at 50~60Hz.

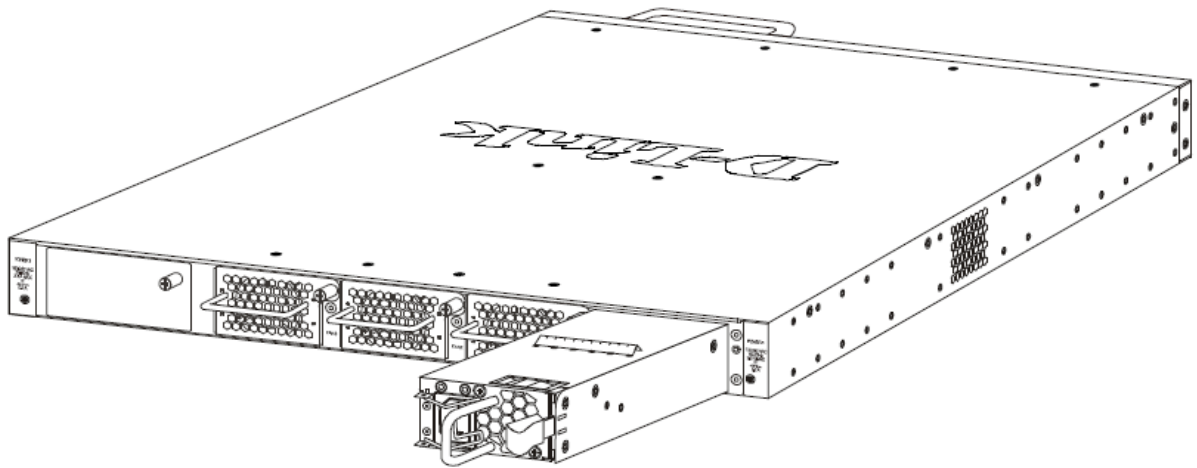

Figure 2-5 Installing an AC Power Supply Module

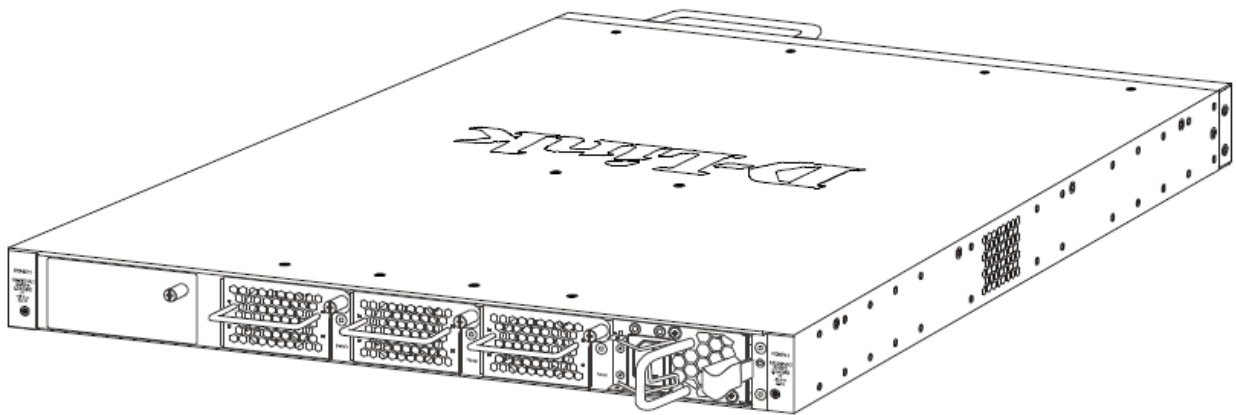

Figure 2-6 Installed AC Power Supply Module

In addition, an optional second AC power supply module can be plugged into the second power supply module slot displayed above. When the primary AC power connection fails, the secondary AC power connection will take over all the power immediately and automatically.

The AC power supply modules are hot-swappable, meaning, that they can be inserted and removed while the switch is powered on. This feature enhances the reliability of this switch.

Installing a DC Power Module

This switch supports a unique dual power input feature. Connect the one end of the DC power cord supplied to a DC power source (-48VDC/5.2A), that will be activated when the AC power is not working. Please make sure that connection polarity (positive and negative) is correct before using this feature to avoid any damaged. Connect the power source to the DC plug before plugging it into the switch. This will protect the switch from a possible shortage on the DC cable.

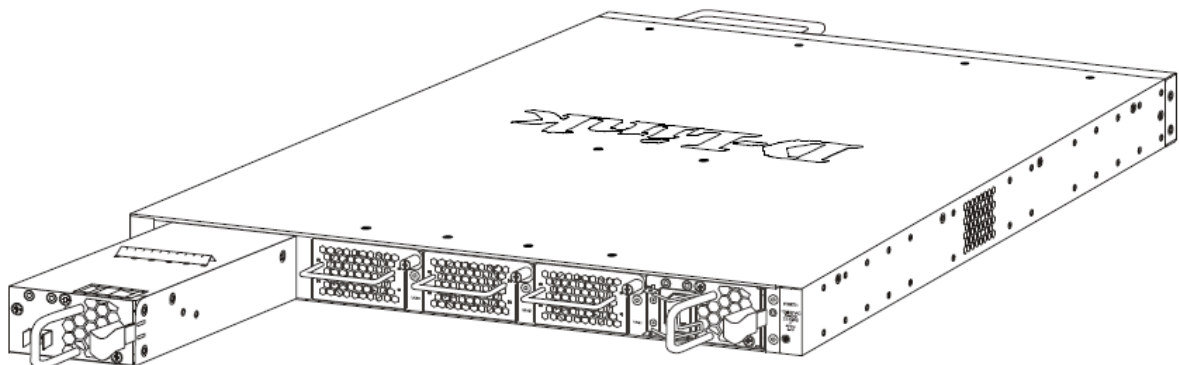

Figure 2-7 Installing a DC Power Supply Module

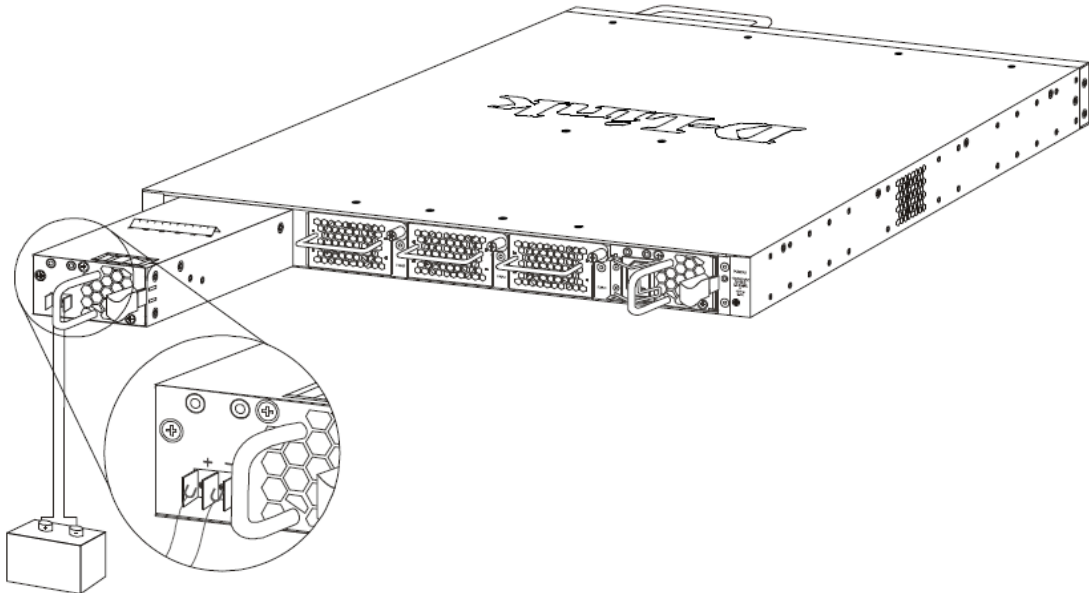

Figure 2-8 Connecting a DC Battery to the DC Power Supply Module

The DC power and AC power of the device will back up each other immediately when one of the power sources fail. If both power sources fail, unplug the switch. When the power source has been restored, plug the switch's power back in.

Before connecting the DC power cable to the DC power input socket, on the switch, the DC power cable must be properly connected to DC source, at your facility, by a qualified, licensed electrician. The DC power cable's wire size must be 18AWG. Connect the DC power cable to a DC main circuit breaker rated no greater than 15A.

If you are installing a DC-powered switch, you must ground the chassis before connecting the switch to the DC power source, following the following instructions:

- Use a minimum of 18 AWG stranded copper wire for grounding. The wire should be long enough to reach from the installed switch to the facility ground point.
- Torque screwdriver with a 1/4-inch flat blade.
- Ground additional hardware appropriately to the earth ground connection at your site.

Installing Fan Modules into the Fan Module Ports

Located on the rear panel of this switch there are three fan module ports.

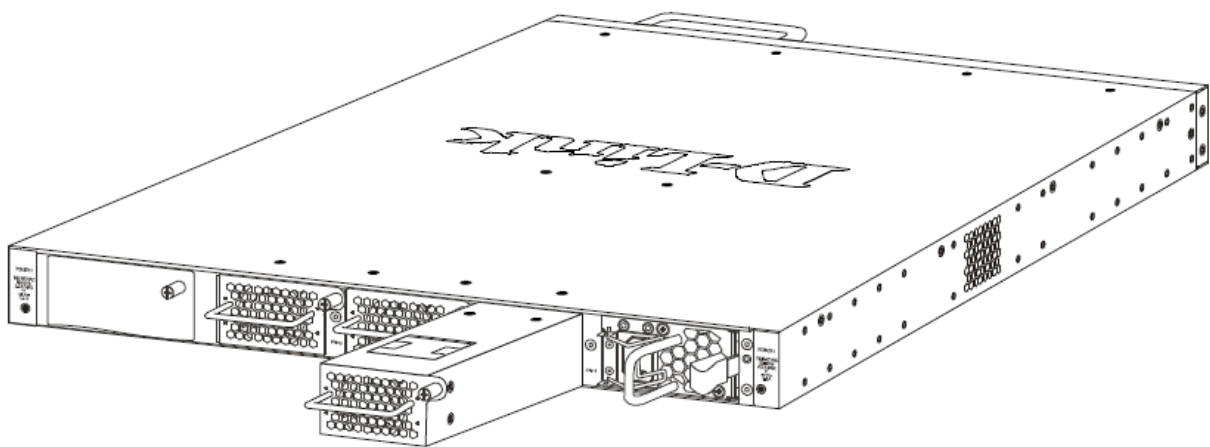

Figure 2-9 Installing a Fan Module

The user can easily remove and insert fan modules into these ports.



NOTE: The Power Modules all support a specific air-flow direction. This air-flow direction must be the **same** as the Fan Module installed. **By default** the air-flow direction of the Power Module and Fan Module installed is **front-to-back**.

Switch Connections

Switch to End Node

Switch to another Switch

Switch Stacking

Switch to a Server

Switch to End Node

End node is a generic name for edge networking devices that will be connected to this switch. Typical examples of end nodes are Personal Computers (PCs), Notebooks, Access Points, Print Servers, VoIP Phones and more. Each end node will be outfitted with a 10/100/1000Mbps, RJ-45, networking port. Normally end nodes will connect to this switch by using a standard twisted-pair, UTP/STP, network cable. After a successful connection, the corresponding Link/Act light will illuminate and blink to indicate that packet activity is taking place on that port.

The diagram below display a typical end node connected to the Switch.

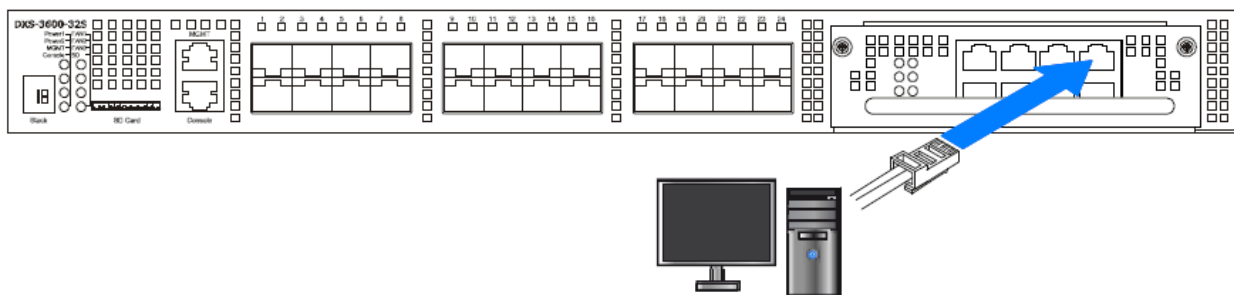

Figure 3-1 Connecting the Switch to an End Node

Switch to another Switch

Another popular configuration is to connect this switch to another switch or hub. This network typography is considered when one Switch does not have enough ports to cater for all the end nodes in the network. There is a great deal of flexibility in the type of cabling that can be used to interlink switches. The copper ports support cables like Categories 3, 4, 5, and 5e running on standards like 10BASE-T, 100BASE-TX, and 1000BASE-T.

Two or more switches can also be interlinked using **fiber-optic cables** or **direct-attached cables** via the switch's SFP, SFP+, and WDM ports. Lastly two or more switches can also be interlinked using QSFP+ interfaces supported by the **DXS-3600-EM-4QXS** optional modules.

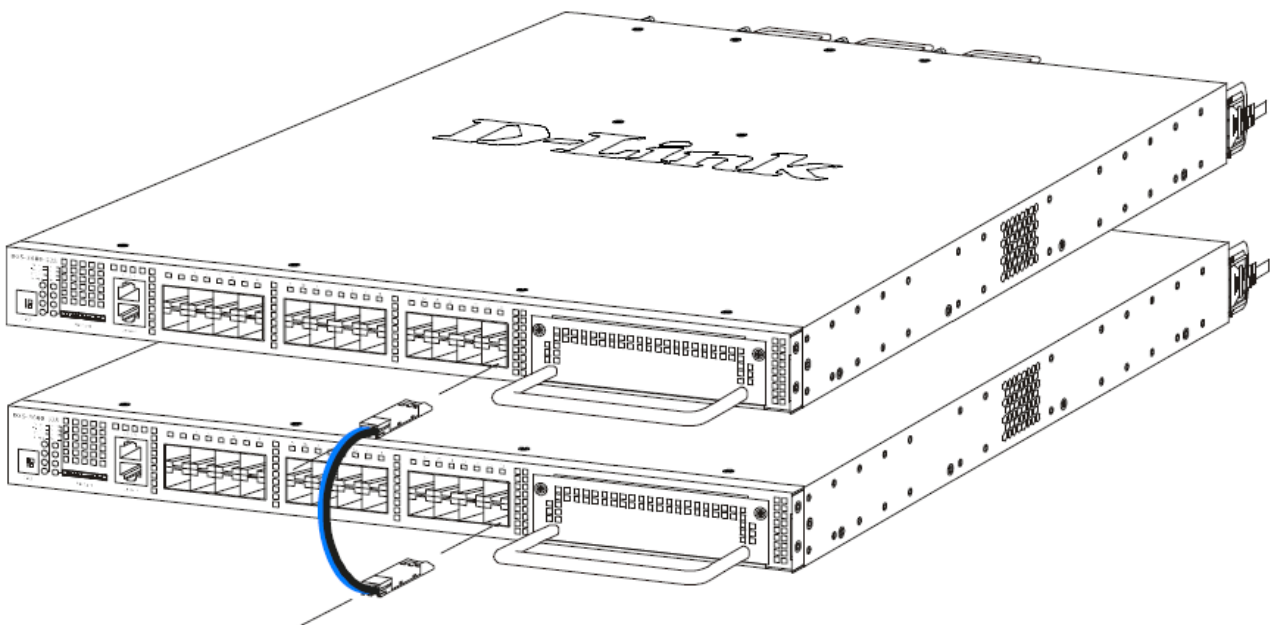

Figure 3-2 Connecting a Switch to another switch by means of SFP/SFP+

Switch Stacking

The **DXS-3600-32S** and **DXS-3600-16S** supports stacking 4 switches together while being managed by one IP address through Telnet, the Web User Interface, the RJ45 console port or through SNMP. This cost effective switch provides an affordable solution for administrators to upgrade their networks using either the **DXS-3600-EM-Stack** or the **DXS-3600-EM-4QXS** modules to scale and stack the switches. This increases overall reliability, serviceability, and availability.

- **Duplex Chain** – The Duplex Chain topology stacks switches together in a chain-link format. Using this method, data transfer is only possible in one direction and if there is a break in the chain, then data transfer will obviously be affected.
- **Duplex Ring** – The Duplex Ring stacks switches in a ring or circle format where data can be transferred in two directions. This topology is very resilient due to the fact that if there is a break in the ring, data can still be transferred through the stacking cables between switches in the stack.

The **DXS-3600-EM-Stack** module (sold separately, and only supported using the **DXS-3600-32S**) uses the CXP Cables (DEM-CB50CXP: CXP to CXP 50cm Stacking Cable) to make the following stacking topologies:

The figure below illustrates how switches can be stacked in a **Duplex Chain** formation using the **DXS-3600-EM-Stack** module.

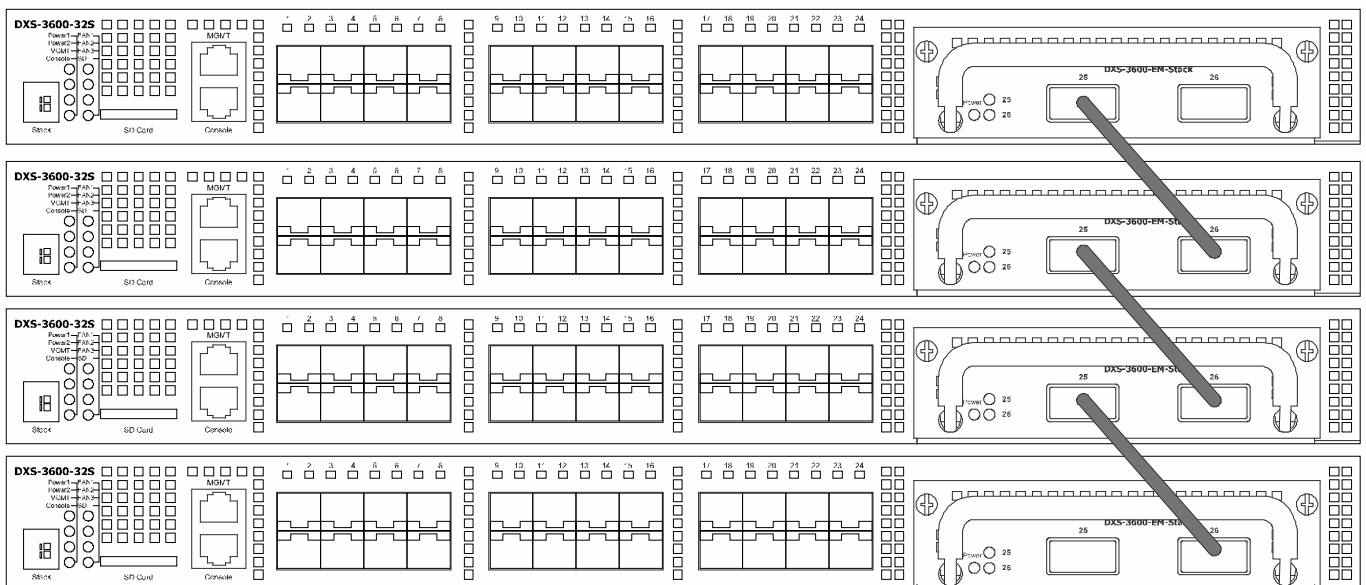

Figure 3-3 Duplex Chain physical stack using the DXS-3600-EM-Stack module

The figure below illustrates how switches can be stacked in a **Duplex Ring** formation using the **DXS-3600-EM-Stack** module.

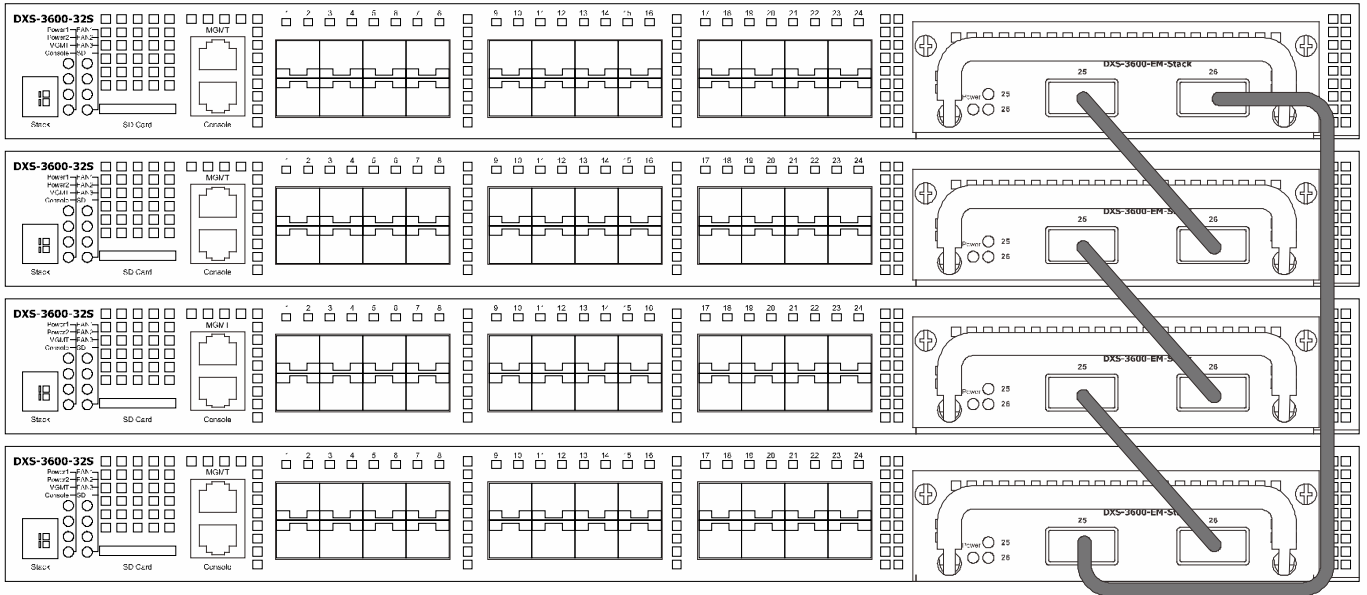

Figure 3-4 Duplex Ring physical stack using the DXS-3600-EM-Stack module

The DXS-3600-EM-4QXS module (sold separately) uses the last two QSFP+ ports to make the following stacking topologies.

The figure below illustrates how switches can be stacked in a **Duplex Chain** formation using the DXS-3600-EM-4QXS module.

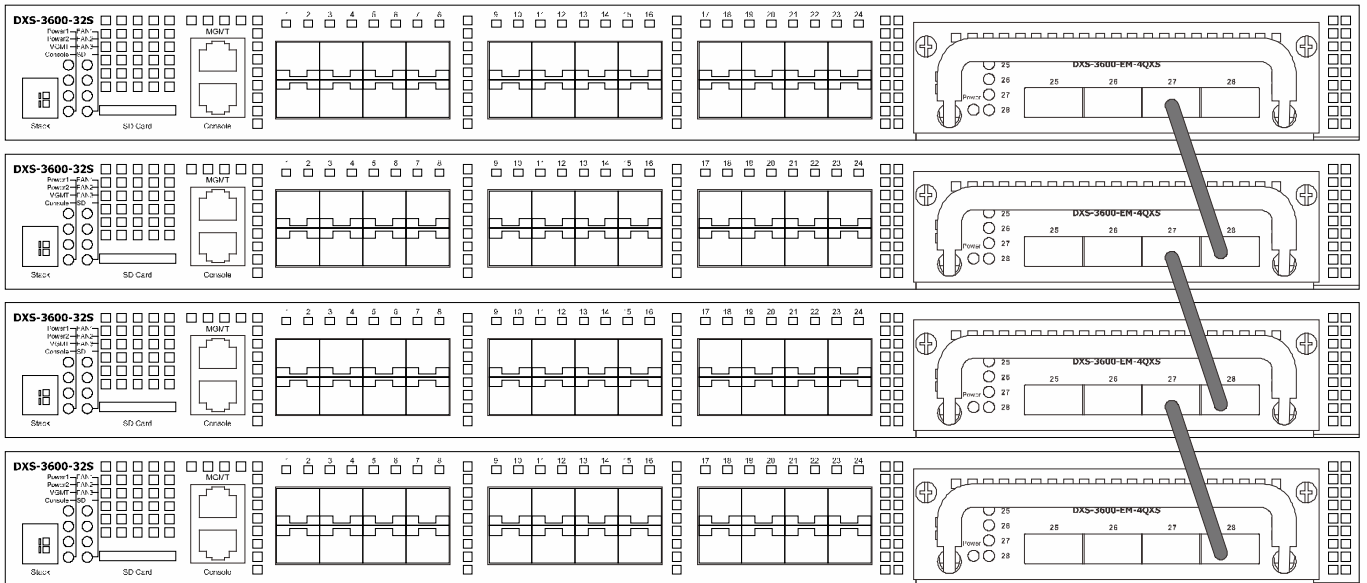

Figure 3-5 Duplex Chain physical stack using the DXS-3600-EM-4QXS module

The figure below illustrates how switches can be stacked in a **Duplex Ring** formation using the DXS-3600-EM-4QXS module.

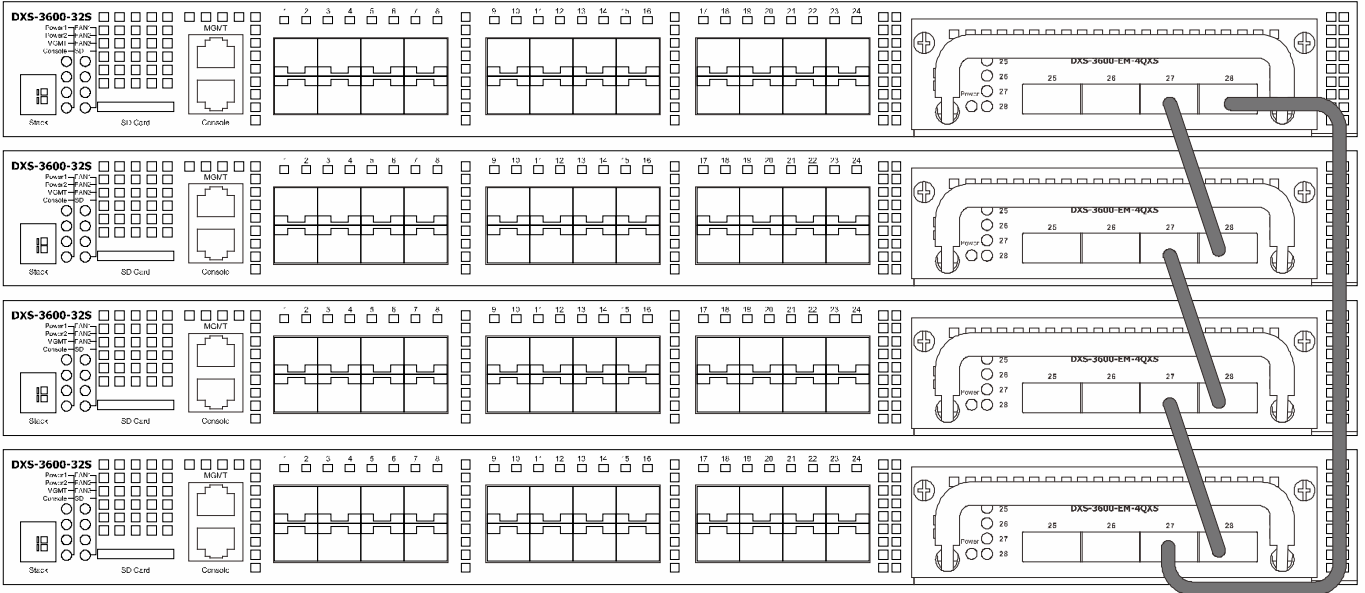

Figure 3-6 Duplex Ring physical stack using the DXS-3600-EM-4QXS module

Switch to a Server

When configuring a network, users will most likely have to add a server or two to this switch. Generally, any port on this switch can be used to connect to a server, as they all operate at a maximum speed of one 10Gbps. What sets this switch apart is the fact that there are powerful software applications available on this switch that specifically caters for better server access, management and security.

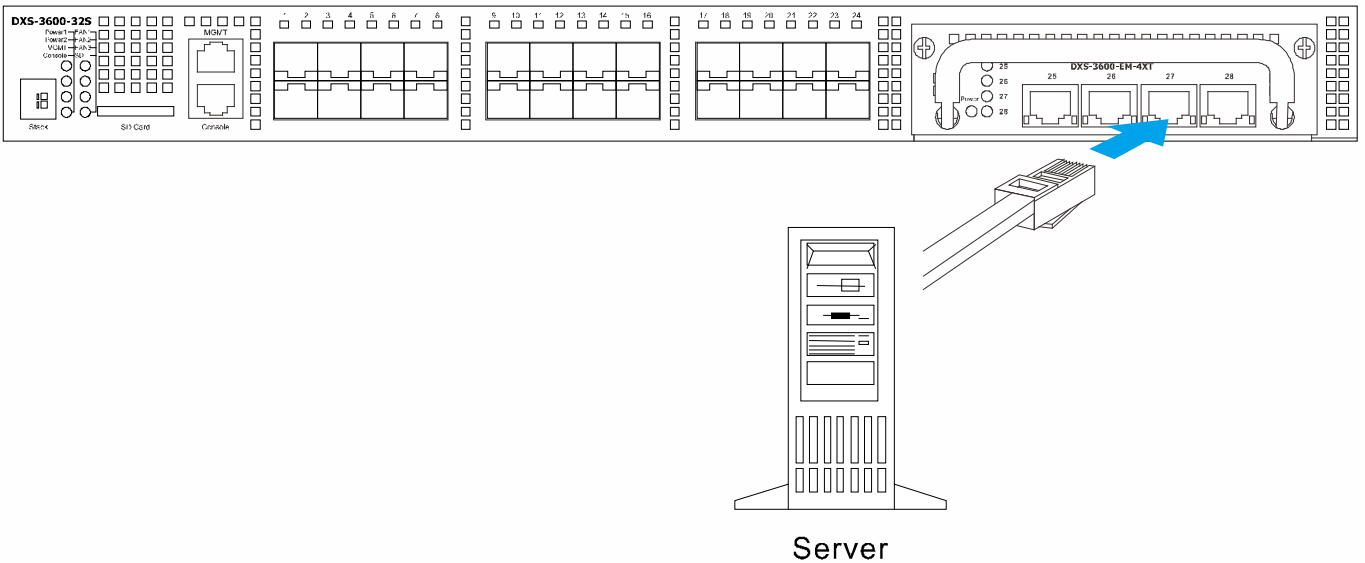

Figure 3-7 Connecting the Switch to a server

Switch Management

Management Options

Connecting to the Console Port

Connecting using SNMP

Connecting using the Web User Interface

Management Options

This switch provides multiple access platforms that can be used to configure, manage and monitor networking features available on this switch. Currently there are three management platforms available and they are described below.

The Command Line Interface (CLI) through the Serial Port or remote Telnet

This switch can be managed, out-of-band, by using the console port on the front panel of the switch. Alternatively, the switch can also be managed, in-band, by using a Telnet connection to any of the LAN ports on this switch. The command line interface provides complete access to all switch management features.

SNMP-based Management

The switch can be managed with an SNMP-compatible console program. The switch supports SNMP version 1.0, version 2.0 and version 3.0. The SNMP agent decodes the incoming SNMP messages and responds to requests with MIB objects stored in the database. The SNMP agent updates the MIB objects to generate statistics and counters.

Web-based Management Interface

After successfully installing the switch, the user can configure the switch, monitor the LED panel, and display statistics graphically using a Web browser, such as Microsoft® Internet Explorer (version 6.0 and later), Mozilla Firefox (version 3.0 and later), Safari (version 4.0 and later), Google Chrome (version 5.0 and later), Opera (version 9.0 and later), and Netscape (version 7.0 and later).

Connecting to the Console Port

The front panel of the switch provides a console port that enables a connection to a computer monitoring and configuring the switch. The console port is an RJ-45 port and requires a special cable that is included with the switch, to establish the physical connection.

To use the console port, the following equipment is needed:

- A terminal or a computer with both an RS-232 serial port and the ability to emulate a terminal.
- A console cable with a male DB-9 connector on one end and an RJ-45 connection on the other. This cable should be included with the switch. It establishes the physical connection to the console port.

Using a terminal to connect to the console port:

Connect the male DB-9 connector on the console cable (shipped with the switch) to the RS-232 serial port on the computer running terminal emulation software then insert the RJ-45 connector into the RJ-45 console port on the front of the switch.

Set the terminal emulation software as follows:

- Select the appropriate serial port (COM1 or COM2).
- Set the data rate to 115200 baud.
- Set the data format to 8 data bits, 1 stop bit, and no parity.
- Set flow control to none.

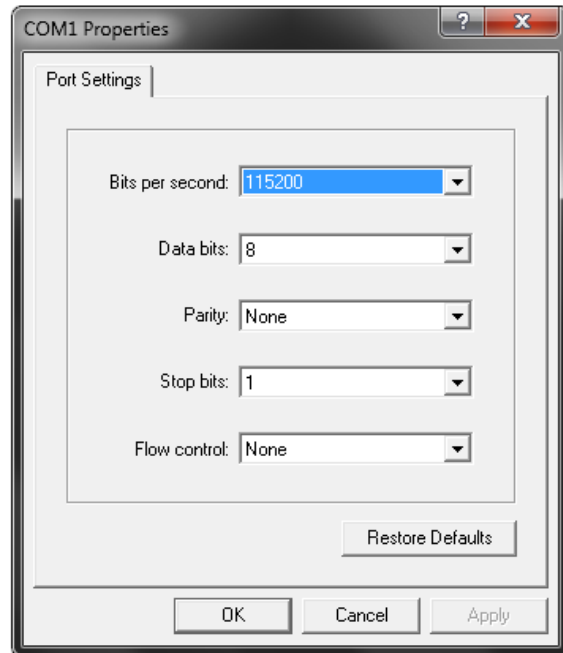

Figure 4-1 COM1 Properties – Port Settings

- Under Properties, select VT100 for Emulation mode.
- Select Terminal keys for Function, Arrow and Ctrl keys. Make sure to use Terminal keys (not Windows keys) are selected

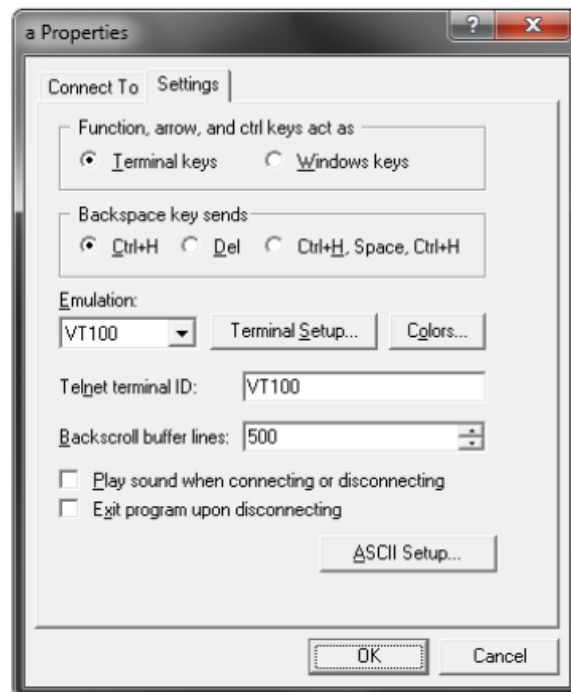

Figure 4-2 COM1 Properties – General Settings



NOTE: When using HyperTerminal with the Microsoft® Windows® 2000 operating system, ensure that Windows 2000 Service Pack 2 or later is installed. Windows 2000 Service Pack 2 allows use of arrow keys in HyperTerminal's VT100 emulation. See www.microsoft.com for information on Windows 2000 service packs.

After correctly configuring the terminal, plug the power cable into the power receptacle on the back of the switch. The boot sequence will appear in the terminal.

```

Boot Procedure                                     V1.10.009
-----
Power On Self Test ..... 100 %

MAC Address   : 00-00-00-11-22-33
H/W Version  : B1

Please Wait, Loading V2.40.038 Runtime Image ..... 100 %
UART init ..... 100 %
Starting runtime image
Device Discovery ..... 100 %
Configuration init ..... 100 %

```

Figure 4-3 Boot up display in console screen

After the boot sequence has been completed, the console login screen will be displayed.

Connecting to the Switch for the First Time

The switch supports user-based security that can allow prevention of unauthorized users from accessing the switch or changing its configuration. This section will explain how to log into the switch's Command Line Interface via the out-of-band console connection.

Upon initial connection to the switch, the login screen appears (see example below).

```

DXS-3600-32S TenGigabit Ethernet Switch

Command Line Interface
Firmware: Build 2.40.038
Copyright (C) 2015 D-Link Corporation. All rights reserved.

Switch>

```

Figure 4-4 The Switch's Login Screen

By default, there is no **Username** and **Password** configured in the account settings of this switch. This will allow the user to simply connect to this Switch for the first time by pressing the '**Enter**' key. After pressing **Enter**, access will be given to enter commands after the command prompt (**Switch>**) appears.



NOTE: The first user automatically gets Administrator level privileges. At least one Administrator-level user account must be created for the switch.

Creating a User Account

As you will have noticed by now is that this switch does not have a default username and password. One of the first and most important tasks will be to create user accounts. Logging in using a predefined administrator-level username will give the user privileged access to the Switch's management software. Also this will prevent unauthorized access to the switch, and record the passwords for future reference.

An example to create an administrator-level account for the Switch called 'NewUser':

```
Switch>enable
Switch#configure terminal
Switch(config)#username NewUser password 12345
Switch(config)#username NewUser privilege 15
Switch(config)#line console
Switch(config-line)#login local
Switch(config-line)#end
Switch#
```

Figure 4-5 To create a user account

In the example above:

1. At the CLI command prompt, enter the **enable** command to enter the **Privileged EXEC Mode**. Press **Enter**.
2. Enter the **configure terminal** command to enter the **Global Configuration Mode**. Press **Enter**.
3. Enter the **username NewUser password 12345** command. Press **Enter**. This will create a user account with the username of NewUser and a password of 12345.
4. Enter the **username NewUser privilege 15** command. Press **Enter**. This will configure this user account to have **Administrative (15)** privileges.
5. Enter the **line console** command to enter the **Line Configuration Mode**. Press **Enter**.
6. Enter the **login local** command. Press **Enter**. This specifies that the local line requires login credentials.
7. Enter the **end** command to exit back to the **Privileged EXEC Mode**.



NOTE: Passwords are case sensitive. Usernames can be up to 19 characters in length. Passwords can be up to 16 characters in length.

Configuring the IP Address

Each switch must be assigned its own IP Address, which is used for communication with an SNMP network manager or other TCP/IP applications. The switch's console default IP address is 10.90.90.90/8, and the management port default IP address is 192.168.0.1/24. You can change the switch's default IP address to fit into your networking address range.

The IP address of the Switch must be configured before it can be managed, by the user, via the Web User Interface.

An example to change the IP address of the Switch to '10.50.50.50', using a subnet mask of '255.0.0.0':

```
Switch>enable
Switch#configure terminal
Switch(config)#interface vlan 1
Switch(config-if)#ip address 10.50.50.50 255.0.0.0
Switch(config-if)#end
Switch#
```

Figure 4-6 To change the IP address

1. At the CLI command prompt, enter the **enable** command to enter the **Privileged EXEC Mode**. Press **Enter**.
2. Enter the **configure terminal** command to enter the **Global Configuration Mode**. Press **Enter**.
3. Enter the **interface vlan 1** command to enter the **Interface Configuration Mode**. Press **Enter**.
4. Enter the **ip address 10.50.50.50 255.0.0.0** command to change the IP address and mask. Press **Enter**.
5. Enter the **end** command to exit back to the **Privileged EXEC Mode**.

The Switch can now be configured and accessed through Telnet or the Web-based management.

The Switch's IP address can also automatically be obtained by using the BOOTP or DHCP protocol.

Connecting using SNMP

The switch can be managed with an SNMP-compatible console program. The Simple Network Management Protocol (SNMP) operates on the Application Layer of the OSI model and is designed specifically for managing and monitoring

network devices. The SNMP agent decodes the incoming SNMP messages and responds to requests with MIB objects stored in the database. The SNMP agent updates the MIB objects to generate statistics and counters.

D-Link provides a professional network management software package, called **D-View 6.0** that uses SNMP to connect, configure, manage and monitor this switch. The D-View[®] 6.0 SNMP Network Management System is a software tool that facilitates the central administration of a network with various SNMP-enabled devices.

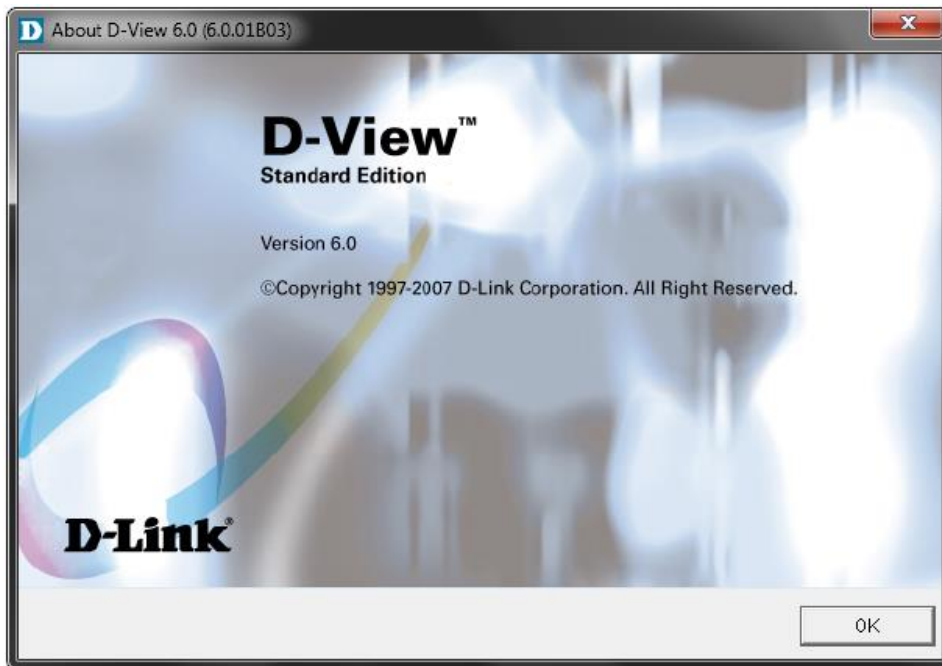

Figure 4-7 D-Link's D-View SNMP Software



NOTE: For customers interested in D-View, D-Link Corporation's proprietary SNMP management software, go to <http://dview.dlink.com.tw/> and download the software and manual.

Managed devices that support SNMP include software (referred to as an agent), which runs locally on the device. A defined set of variables (managed objects) is maintained by the SNMP agent and used to manage the device. These objects are defined in a Management Information Base (MIB), which provides a standard presentation of the information controlled by the on-board SNMP agent. SNMP defines both the format of the MIB specifications and the protocol used to access this information over the network.

This switch supports **SNMPv1**, **SNMPv2c** and **SNMPv3**. The administrator may specify which version of SNMP to use to monitor and control the switch. The three versions of SNMP vary in the level of security provided between the management station and the network device.

In SNMPv1 and SNMPv2c, user authentication is accomplished using 'community strings', which function like passwords. The remote user SNMP application and the Switch's SNMP must use the same community string. SNMP packets from any station that has not been authenticated are ignored (dropped).

The **default community strings** for the Switch used for SNMPv1 and SNMPv2c are:

- **public** - Allows authorized management stations to retrieve MIB objects.
- **private** - Allows authorized management stations to retrieve and modify MIB objects

```
Switch#configure terminal
Switch(config)#snmp
Switch(config)#show snmp community

Community: public
Access: read-only
View: CommunityView

Community: private
Access: read-write
View: CommunityView

Total Entries:2

Switch(config)#
```

Figure 4-8 To view the SNMP community strings

SNMPv3 uses a more sophisticated authentication process that is separated into two parts.

1. The first part is to maintain a list of users and their attributes that are allowed to act as SNMP managers.
2. The second part describes what each user on that list can do as an SNMP manager.

The switch allows groups of users to be created and configured with a shared set of privileges. The SNMP version may also be configured for a specific group of SNMP managers. A group of SNMP managers can be created to view read-only information or to receive traps using SNMPv1 while assigning a higher level of security to another group, granting read/write privileges using SNMPv3.

Using SNMPv3, individual users or groups of SNMP managers can be allowed to perform or be restricted from performing specific SNMP management functions. The functions allowed or restricted are defined using the Object Identifier (OID) associated with a specific MIB. An additional layer of security is available for SNMPv3 in which SNMP messages may be encrypted.

Traps

Traps are messages that alert network personnel of events that occur on the switch. The events can be as serious as a reboot (someone accidentally turned OFF the switch), or less serious like a port status change. The switch generates traps and sends them to the trap recipient (or network manager). Typical traps include trap messages for Authentication Failure, and Topology Change.

Management Information Base (MIB)

The Management Information Base (MIB) stores management and counter information. The switch uses the standard MIB-II Management Information Base module. Consequently, values for MIB objects can be retrieved from any SNMP-based network management software. In addition to the standard MIB-II, the Switch also supports its own proprietary enterprise MIB as an extended Management Information Base. The proprietary MIB may also be retrieved by specifying the MIB Object Identifier. MIB values can be either read-only or read-write.

Connecting using the Web User Interface

Only some software functions of the switch can be managed, configured, and monitored via the embedded Web-based (HTML) interface. This can be done from any remote station on the network through a standard web browser, such as Internet Explorer (version 6.0 and later), Mozilla Firefox (version 3.0 and later), Safari (version 4.0 and later), Google Chrome (version 5.0 and later), Opera (version 9.0 and later), or Netscape (version 7.0 and later). The browser acts as a universal access tool and can communicate directly with the switch using the HTTP protocol.

The Command Line Interface provides the functionality of managing, configuring, and monitoring all of the software features that are available on this Switch.

Logging onto the Web Manager

To access the Web User Interface the user simply runs the standard web browser and enter the Switch's IP address into the address bar of the browser and press the 'Enter' key. By default, the **Management** port, located just above the Console port, can be accessed using the IP address of **192.168.0.1/24**. To access any of the other normal LAN ports, other than the Management port, the user needs to configure an IP address for this interface first before it can be accessed via the Web User Interface.



NOTE: To be able to connect to the Web User Interface, a user account must be created first using the Command Line Interface. By default, there are no user accounts configured on this Switch.

Below, we have an example of how to access the Web User Interface from a normal LAN port. The IP address configured for this port is 10.90.90.90. For more information about configuring the IP address, refer to [Configuring the IP Address](#) on page 23.



Figure 4-9 Displays entering the IP address in Internet Explorer

This will open the user authentication window, as seen below.



Figure 4-10 Enter Network Password Window

Enter the login **User name** and **Password** and click **OK** to proceed. This will open the Web-based User Interface. The switch management features available in the Web-based manager are explained below.

To be able to connect to the Web User Interface, a user account must be created first using the Command Line Interface. For more information about creating a user account, see [Creating a User Account](#) on page 25.

Areas of the User Interface

After a successful connection to the Web User Interface has been made, the following page should be displayed.

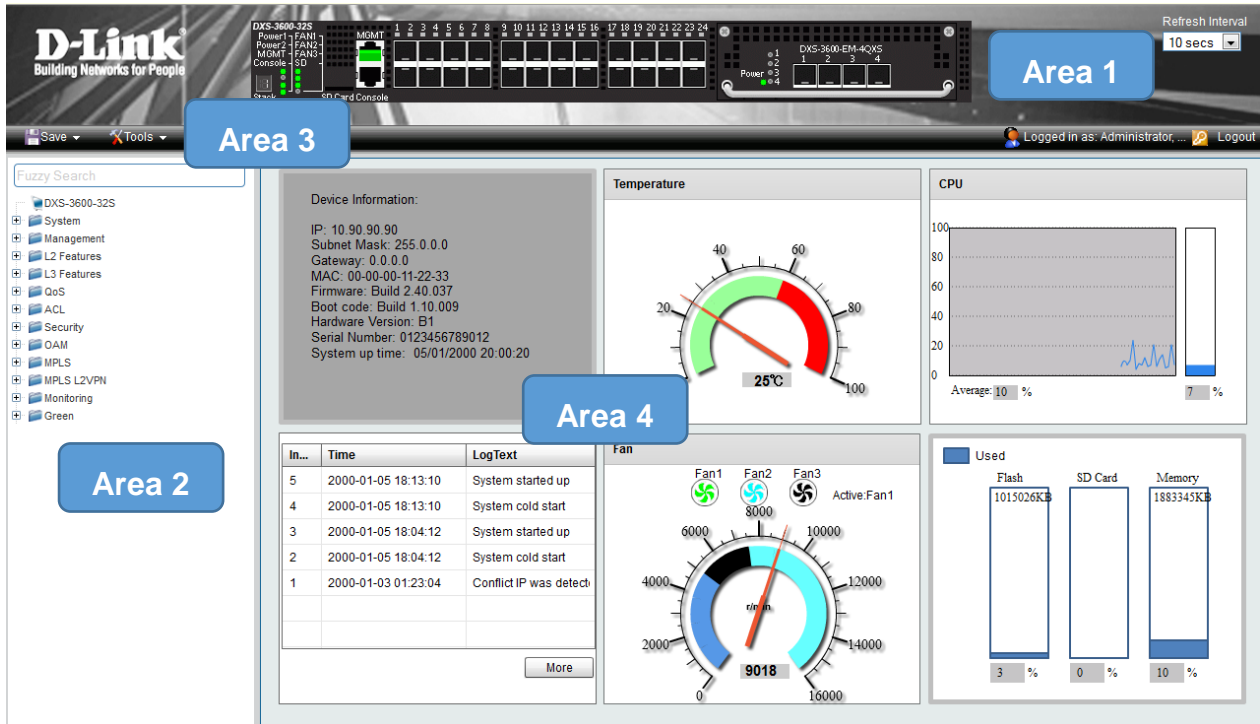

Figure 4-11 Main Web Manager Window

On this page we will find three main areas to observe.

Area Number	Function
AREA 1	This area displays a graphical, near real-time image of the front panel of the Switch. This area displays the Switch's ports and expansion modules. It also shows port activity based on a specific mode. Some management functions, including port monitoring are accessible from here. Click the D-Link to go to the D-Link website.
AREA 2	This area displays a file explorer-type menu tree of all configurable options. Select the folder or window to display. Open folders and click the hyperlinked window buttons and subfolders contained within them to display information pertaining to that category.
AREA 3	This area displays a toolbar used to access Save and Tools menus.
AREA 4	This area displays graphical, real-time monitoring gauges of Device Information , Temperature , CPU Usage , System Log , Fan Status , and Memory Usage .

Appendix A - Technical Specifications

Product Specifications	
Switch Series	DXS-3600-16S: 8-Port 10Gigabit SFP+, Expandable, Layer 2/3 switch. DXS-3600-32S: 24-Port 10Gigabit SFP+, Expandable, Layer 2/3 switch.
Dimensions	DXS-3600-16S: 440mm (W) x 506mm (D) x 44mm (H), 19-inch, 1U Rack-mount size DXS-3600-32S: 440mm (W) x 506mm (D) x 44mm (H), 19-inch, 1U Rack-mount size
Weight	DXS-3600-16S: 9.89kg (21.8lb) DXS-3600-32S: 9.84kg (21.6lb)
Internal Power Supply	DXS-3600-16S: AC Input: 100~240VAC, 50~60Hz, 1.7A DXS-3600-32S: AC Input: 100~240VAC, 50~60Hz, 2.3A
Optional Power Supply	DC Input: -48VDC, 5.2A
Fans	3 Removable Fan Modules, front-to-back/back-to-front airflow
Removable Media	SD Card: Maximum 32Gb SDHC Capacity.
Stacking	Physical Stacking: DXS-3600-32S: Supports 4 stacking units with EM-Stack / EM-4QXS modules DXS-3600-16S: Supports 4 stacking units with EM-4QXS modules via the last two ports. Virtual Stacking / Clustering: <ul style="list-style-type: none"> Support D-Link Single IP Management v1.61 Use a single IP to manage the virtual stack with up to 32 D-Link Layer 2/3 switches.

Performance Specifications	
Switch Capacity	DXS-3600-16S: 480Gbps DXS-3600-32S: 960Gbps
Packet Forwarding Rate	DXS-3600-16S: 357.17Mpps DXS-3600-32S: 714.28Mpps
Packet Buffer Size	9 MBytes
MAC Address Table	128K MAC Address Table with 1K Static MAC Addresses
Power Consumption	DXS-3600-16S: 144.6 Watt DXS-3600-32S: 115.3 Watt (Without expansion module)
IP Routing Tables	IPv4/IPv6: 16K Entries IPv6: 8K Entries
IP Host Tables	IPv4: 8K Entries IPv6: 4K Entries
Jumbo Frame Size	12KBytes
Transmission Method	Store-and-forward, Cut through
Forwarding Rates	14,880pps (10M) 148,800pps (100M) 1,488,000pps (1G) 14,880,000pps (10G)
Stacking Ports	Bandwidth: <ul style="list-style-type: none"> 480G (Bi-direction) via EM-Stack module

Performance Specifications

- 160G (Bi-direction) via EM-4QXS module

Environmental Specifications

Temperature	Operating: 0° to 45°C (32° to 113°F) Storage: -40° to 70°C (-40° to 158°F)
Humidity	Operating: 0% to 95% RH, Non-condensing Storage: 0% to 95% RH, Non-condensing
Heat Dissipation	393.173 BTU/Hr
Emissions	CE Class A, FCC Class A, VCCI Class A, C-Tick Class A
Safety	CB Report, UL/cUL Listed Mark

Port Specifications

Console Port	RJ-45 interface for out-of-band CLI configuration
Copper Ports	DXS-3600-EM-8T Expansion Module 10/100/1000BASE-T ports compliant to the following standards: <ul style="list-style-type: none"> • IEEE 802.3 compliance • IEEE 802.3u compliance • Supports Full-Duplex operations • IEEE 802.3x Flow Control support for Full-Duplex mode • IEEE 802.3ab compliance
	DXS-3600-EM-4XT Expansion Module 10GBASE-T ports compliant to the following standards: IEEE 802.3an compliance
SFP Ports	Compliant to following standards: <ul style="list-style-type: none"> • IEEE 802.3z compliance • IEEE 802.3x Flow Control support for Full-Duplex mode. • Support Auto-negotiation for Full-Duplex/ flow control operations.
	SFP Transceivers Supported: <ul style="list-style-type: none"> • DEM-310GT (1000BASE-LX, Single-mode, 10km) • DEM-311GT (1000BASE-SX, Multi-mode, 550m) • DEM-312GT2 (1000BASE-SX, Multi-mode, 2km) • DEM-314GT (1000BASE-LHX, Single-mode, 50km) • DEM-315GT (1000BASE-ZX, Single-mode, 80km) • DGS-712 (1000BASE-T Copper, 100m)
	WDM Transceivers Supported: <ul style="list-style-type: none"> • DEM-330T/R (1000BASE-BX, Single-Mode 10km) • DEM-331T/R (1000BASE-BX, Single-Mode 40km)
SFP+ Ports	Compliant to following standards: <ul style="list-style-type: none"> • IEEE 802.3ae compliance • IEEE 802.3aq compliance
	SFP+ Expansion module: <ul style="list-style-type: none"> • DXS-3600-EM-8XS
	SFP+ Transceivers Supported: <ul style="list-style-type: none"> • DEM-431XT (10GBASE-SR (w/o DDM), 80m:OM1 & OM2 MMF, 300m: OM3 MMF) • DEM-431XT-DD (10GBASE-SR (DDM), 80m:OM1 & OM2 MMF, 300m: OM3 MMF) • DEM-432XT (10GBASE-LR, 10km (w/o DDM))

Port Specifications	
	<ul style="list-style-type: none"> DEM-432XT-DD (10GBASE-LR, 10km (DDM)) DEM-433XT (10GBASE-ER, 40km (w/o DDM)) DEM-433XT-DD (10GBASE-ER, 40km (DDM)) DEM-434XT (10GBASE-ER, 80km (w/o DDM)) DEM-435XT (10GBASE-LRM (w/o DDM), 220m:OM1 & OM2 MMF, 300m: OM3 MMF) DEM-435XT-DD (10GBASE-LRM (DDM), 220m:OM1 & OM2 MMF, 300m:OM3 MMF) DEM-436XT-BXU (10GBASE-LR BiDi (w/o DDM) 20km, TX:1270nm, RX:1330nm) DEM-436XT-BXD (10GBASE-LR BiDi (w/o DDM) 20km, TX:1330nm, RX:1270nm) DEM-X10CS-1271 (10G Single-Mode 10KM CWDM SFP+ Transceiver 1271nm) DEM-X10CS-1291 (10G Single-Mode 10KM CWDM SFP+ Transceiver 1291nm) DEM-X10CS-1311 (10G Single-Mode 10KM CWDM SFP+ Transceiver 1311nm) DEM-X10CS-1331 (10G Single-Mode 10KM CWDM SFP+ Transceiver 1331nm) DEM-X40CS-1471 (10G Single-Mode 40KM CWDM SFP+ Transceiver 1471nm) DEM-X40CS-1491 (10G Single-Mode 40KM CWDM SFP+ Transceiver 1491nm) DEM-X40CS-1511 (10G Single-Mode 40KM CWDM SFP+ Transceiver 1511nm) DEM-X40CS-1571 (10G Single-Mode 40KM CWDM SFP+ Transceiver 1571nm) <p>SFP+ Direct Attached Cables (DAC):</p> <ul style="list-style-type: none"> Direct Attached Cables are cables with built-in SFP+ transceivers at both ends. DEM-CB100S (10GbE SFP+ 1m Direct Attach Cable) DEM-CB300S (10GbE SFP+ 3m Direct Attach Cable) DEM-CB700S (10GbE SFP+ 7m Direct Attach Cable)
QSFP+ Ports	<p>Compliant to following standards:</p> <ul style="list-style-type: none"> IEEE 802.3ba compliance IEEE 802.3ae compliance
	<p>QSFP+ Expansion Module:</p> <ul style="list-style-type: none"> DXS-3600-EM-4QXS
	<p>QSFP+ Transceivers Supported:</p> <ul style="list-style-type: none"> DEM-QX01Q-SR4 (40GBASE-SR4 Multi-mode, OM3:100M/OM4:150M) DEM-QX10Q-LR4 (40GBASE-LR4 Single-mode, 10KM)
	<p>QSFP+ Direct Attached Cables (QSFP+ DAC): Direct Attached Cables are cables with built-in QSFP+ or SFP+ transceivers at both ends</p> <ul style="list-style-type: none"> DEM-CB100QXS: QSFP+ to QSFP+ 1m Direct Attach Cable DEM-CB300QXS: QSFP+ to QSFP+ 3m Direct Attach Cable DEM-CB100QXS-4XS: QSFP+ to 4 x SFP+ 1m Direct Attach Splitter Cable
Stacking Ports	<p>Physical Stacking Module: DXS-3600-EM-Stack 2*120G CXP physical stacking module (for DXS-3600-32S only)</p>
	<p>CXP Cables: DEM-CB50CXP: CXP to CXP 50cm Stacking Cable</p>

LED Indicators				
Location	LED	Color	Status	Description
Per Device	Power 1, Power 2	Green	Light on (Solid)	Power on
			Light off	Power off
		Amber	Light on (Solid)	Power supply failure

LED Indicators				
Location	LED	Color	Status	Description
			Light blinking	Power supply module present, but AC or DC input is problematic. A reversed airflow power supply was inserted.
	Management (MGMT)	Green	Light on (Solid)	Link present. No data transmission.
			Light blinking	Activity. Data transmission
			Light off	No link present or the port was shutdown.
	Console	Green	Light on (Solid)	Console on
			Light off	Console off
	Fan 1, Fan 2, Fan 3	Green	Light on (Solid)	Diagnostics pass. Functioning normal.
			Light off	No Power
		Amber	Light on (Solid)	Busy booting or running diagnostics.
			Light blinking	Fan failure or reversed airflow fan was inserted.
	SD	Green	Light on (Solid)	SD plugged in.
			Light blinking	Busy reading/writing.
			Light off	No link.
		Red	Light on (Solid)	Read/Write failure.
	Stacking ID (7-segment LED) (For DXS-3600-32S-B1 only)	Green	Light on (1-4)	Stacking number displayed.
			Light on (H)	Stacking Master
			Light on (h)	Stacking Backup Master
			Light on (E)	System self-test error
			Light on (G)	Safeguard Engine in exhausted mode.

LED Indicators				
Location	LED	Color	Status	Description
LED Per Port (10/100/1000Mbps)	Link/Act/Speed	Green	Light on (Solid)	When there is a secure connection (or link) to 1000Mbps Ethernet device at any of the ports.
			Light blinking	When there is reception or transmission of data occurring at 1000Mbps.
		Amber	Light on (Solid)	When there is a secure connection (or link) to 10/100Mbps Ethernet device at any of the ports.
			Light blinking	When there is reception or transmission of data occurring at 10/100Mbps.
		Off	Light off	No link
LED Per Port (SFP+, 10Gbps)	Link/Act/Speed	Green	Light on (Solid)	When there is a secure connection (or link) to 10Gbps Ethernet device at any of the ports.
			Light blinking	When there is reception or transmission of data occurring at 10Gbps.
		Amber	Light on (Solid)	When there is a secure connection (or link) to 1000Mbps Ethernet device at any of the ports.
			Light blinking	When there is reception or transmission of data occurring at 1000Mbps.
		Off	Light off	No link
LED Per Port (QSFP, 40Gbps)	Link/Act/Speed	Green	Light on (Solid)	When there is a secure connection (or link) to 10/40Gbps Ethernet device at any of the ports.

LED Indicators				
Location	LED	Color	Status	Description
			Light blinking	When there is reception or transmission of data occurring at 10/40Gbps.
		Amber	Light on (Solid)	When there is a secure connection (or link) to 1Gbps Ethernet device at any of the ports.
			Light blinking	When there is reception or transmission of data occurring at 1Gbps.
		Off	Light off	No link

Appendix B - Cables and Connectors

Ethernet Cable

When connecting the Switch to another switch, a bridge or hub, a normal cable is necessary. Please review these products for matching cable pin assignment.

The following diagrams and tables show the standard RJ-45 receptacle/connector and their pin assignments.

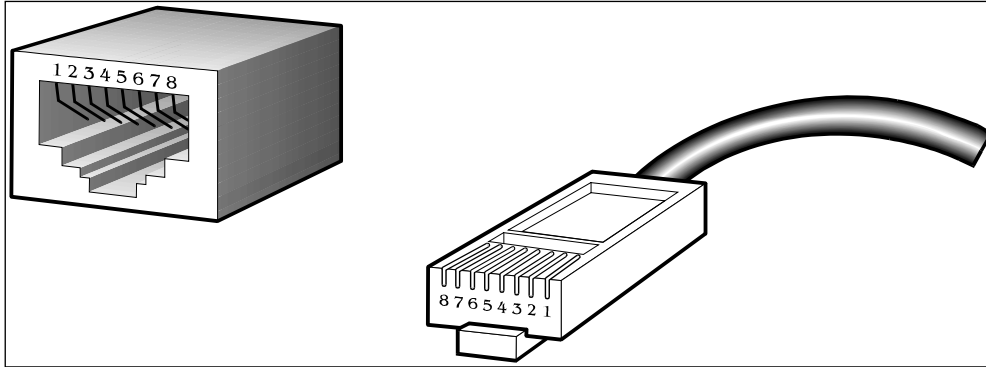

Figure B-1 Standard RJ-45 port and connector

RJ-45 Pin Assignment

Contact	MDI-X Port	MDI-II Port
1	RD+ (receive)	TD+ (transmit)
2	RD - (receive)	TD - (transmit)
3	TD+ (transmit)	RD+ (receive)
4	1000BASE-T	1000BASE-T
5	1000BASE-T	1000BASE-T
6	TD - (transmit)	RD - (receive)
7	1000BASE-T	1000BASE-T
8	1000BASE-T	1000BASE-T

Console Cable

A console cable is used when a user want to connect to the console port, of the switch, to access the command line interface. The following diagrams and tables show the standard Console-to-RJ45 receptacle/connector and their pin assignments.

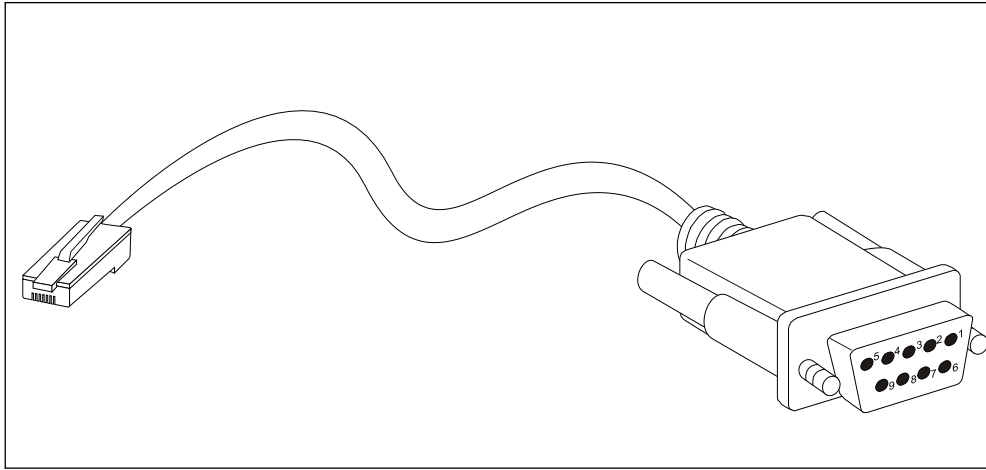

Figure B-2 Console-to-RJ-45 Cable

Contact	Console (DB9/RS232)	RJ-45
1	Not Used	Not Used
2	RXD	Not Used
3	TXD	TXD
4	Not Used	GND
5	GND (shared)	GND
6	Not Used	RXD
7	Not Used	Not Used
8	Not Used	Not Used

Subject to the terms and conditions set forth herein, D-Link Systems, Inc. ("D-Link") provides this Limited Warranty:

- Only to the person or entity that originally purchased the product from D-Link or its authorized reseller or distributor, and
- Only for products purchased and delivered within the fifty states of the United States, the District of Columbia, U.S. Possessions or Protectorates, U.S. Military Installations, or addresses with an APO or FPO.

Limited Warranty: D-Link warrants that the hardware portion of the D-Link product described below ("Hardware") will be free from material defects in workmanship and materials under normal use from the date of original retail purchase of the product, for the period set forth below ("Warranty Period"), except as otherwise stated herein.

Limited Lifetime Warranty for the product is defined as follows:

- Hardware: For as long as the original customer/end user owns the product, or five (5) years after product discontinuance, whichever occurs first (excluding power supplies and fans)
- Power supplies and fans: Three (3) Year
- Spare parts and spare kits: Ninety (90) days

The customer's sole and exclusive remedy and the entire liability of D-Link and its suppliers under this Limited Warranty will be, at D-Link's option, to repair or replace the defective Hardware during the Warranty Period at no charge to the original owner or to refund the actual purchase price paid. Any repair or replacement will be rendered by D-Link at an Authorized D-Link Service Office. The replacement hardware need not be new or have an identical make, model or part. D-Link may, at its option, replace the defective Hardware or any part thereof with any reconditioned product that D-Link reasonably determines is substantially equivalent (or superior) in all material respects to the defective Hardware. Repaired or replacement hardware will be warranted for the remainder of the original Warranty Period or ninety (90) days, whichever is longer, and is subject to the same limitations and exclusions. If a material defect is incapable of correction, or if D-Link determines that it is not practical to repair or replace the defective Hardware, the actual price paid by the original purchaser for the defective Hardware will be refunded by D-Link upon return to D-Link of the defective Hardware. All Hardware or part thereof that is replaced by D-Link, or for which the purchase price is refunded, shall become the property of D-Link upon replacement or refund.

Limited Software Warranty: D-Link warrants that the software portion of the product ("Software") will substantially conform to D-Link's then current functional specifications for the Software, as set forth in the applicable documentation, from the date of original retail purchase of the Software for a period of ninety (90) days ("Software Warranty Period"), provided that the Software is properly installed on approved hardware and operated as contemplated in its documentation. D-Link further warrants that, during the Software Warranty Period, the magnetic media on which D-Link delivers the Software will be free of physical defects. The customer's sole and exclusive remedy and the entire liability of D-Link and its suppliers under this Limited Warranty will be, at D-Link's option, to replace the non-conforming Software (or defective media) with software that substantially conforms to D-Link's functional specifications for the Software or to refund the portion of the actual purchase price paid that is attributable to the Software. Except as otherwise agreed by D-Link in writing, the replacement Software is provided only to the original licensee, and is subject to the terms and conditions of the license granted by D-Link for the Software. Replacement Software will be warranted for the remainder of the original Warranty Period and is subject to the same limitations and exclusions. If a material non-conformance is incapable of correction, or if D-Link determines in its sole discretion that it is not practical to replace the non-conforming Software, the price paid by the original licensee for the non-conforming Software will be refunded by D-Link; provided that the non-conforming Software (and all copies thereof) is first returned to D-Link. The license granted respecting any Software for which a refund is given automatically terminates.

Non-Applicability of Warranty: The Limited Warranty provided hereunder for Hardware and Software portions of D-Link's products will not be applied to and does not cover any refurbished product and any product purchased through the inventory clearance or liquidation sale or other sales in which D-Link, the sellers, or the liquidators expressly disclaim their warranty obligation pertaining to the product and in that case, the product is being sold "As-Is" without any warranty whatsoever including, without limitation, the Limited Warranty as described herein, notwithstanding anything stated herein to the contrary.

Submitting A Claim: The customer shall return the product to the original purchase point based on its return policy. In case the return policy period has expired and the product is within warranty, the customer shall submit a claim to D-Link as outlined below:

- The customer must submit with the product as part of the claim a written description of the Hardware defect or Software nonconformance in sufficient detail to allow D-Link to confirm the same, along with proof of purchase of the product (such as a copy of the dated purchase invoice for the product) if the product is not registered.
- The customer must obtain a Case ID Number from D-Link Technical Support at 1-877-453-5465, who will attempt to assist the customer in resolving any suspected defects with the product. If the product is considered defective, the customer must obtain a Return Material Authorization ("RMA") number by completing the RMA form and entering the assigned Case ID Number at <https://rma.dlink.com/>.
- After an RMA number is issued, the defective product must be packaged securely in the original or other suitable shipping package to ensure that it will not be damaged in transit, and the RMA number must be prominently marked on the outside of the package. Do not include any manuals or accessories in the shipping package. D-Link will only replace the defective portion of the product and will not ship back any accessories.
- The customer is responsible for all in-bound shipping charges to D-Link. No Cash on Delivery ("COD") is allowed. Products sent COD will either be rejected by D-Link or become the property of D-Link. Products shall be fully insured by the customer and shipped to **D-Link Systems, Inc., 17595 Mt. Herrmann, Fountain Valley, CA 92708**. D-Link will not be held responsible for any packages that are lost in transit to D-Link. The repaired or replaced packages will be shipped to the customer via UPS Ground or any common carrier selected by D-Link. Return shipping charges shall be prepaid by D-Link if you use an address in the United States, otherwise we will ship the product to you freight collect. Expedited shipping is available upon request and provided shipping charges are prepaid by the customer.

D-Link may reject or return any product that is not packaged and shipped in strict compliance with the foregoing requirements, or for which an RMA number is not visible from the outside of the package. The product owner agrees to pay D-Link's reasonable handling and return shipping charges for any product that is not packaged and shipped in accordance with the foregoing requirements, or that is determined by D-Link not to be defective or non-conforming.

What Is Not Covered: The Limited Warranty provided herein by D-Link does not cover: Products that, in D-Link's judgment, have been subjected to abuse, accident, alteration, modification, tampering, negligence, misuse, faulty installation, lack of reasonable care, repair or service in any way that is not contemplated in the documentation for the product, or if the model or serial number has been altered, tampered with, defaced or removed; Initial installation, installation and removal of the product for repair, and shipping costs; Operational adjustments covered in the operating manual for the product, and normal maintenance; Damage that occurs in shipment, due to act of God, failures due to power surge, and cosmetic damage; Any hardware, software, firmware or other products or services provided by anyone other than D-Link; and Products that have been purchased from inventory clearance or liquidation sales or other sales in which D-Link, the sellers, or the liquidators expressly disclaim their warranty obligation pertaining to the product. While necessary maintenance or repairs on your Product can be performed by any company, we recommend that you use only an Authorized D-Link Service Office. Improper or incorrectly performed maintenance or repair voids this Limited Warranty.

Disclaimer of Other Warranties: EXCEPT FOR THE LIMITED WARRANTY SPECIFIED HEREIN, THE PRODUCT IS PROVIDED "AS-IS" WITHOUT ANY WARRANTY OF ANY KIND WHATSOEVER INCLUDING, WITHOUT LIMITATION, ANY WARRANTY OF MERCHANTABILITY, FITNESS FOR A PARTICULAR PURPOSE AND NON-INFRINGEMENT. IF ANY IMPLIED WARRANTY CANNOT BE DISCLAIMED IN ANY TERRITORY WHERE A PRODUCT IS SOLD, THE DURATION OF SUCH IMPLIED WARRANTY SHALL BE LIMITED TO NINETY (90) DAYS. EXCEPT AS EXPRESSLY COVERED UNDER THE LIMITED WARRANTY PROVIDED HEREIN, THE ENTIRE RISK AS TO THE QUALITY, SELECTION AND PERFORMANCE OF THE PRODUCT IS WITH THE PURCHASER OF THE PRODUCT.

Limitation of Liability: TO THE MAXIMUM EXTENT PERMITTED BY LAW, D-LINK IS NOT LIABLE UNDER ANY CONTRACT, NEGLIGENCE, STRICT LIABILITY OR OTHER LEGAL OR EQUITABLE THEORY FOR ANY LOSS OF USE OF THE PRODUCT, INCONVENIENCE OR DAMAGES OF ANY CHARACTER, WHETHER DIRECT, SPECIAL, INCIDENTAL OR CONSEQUENTIAL (INCLUDING, BUT NOT LIMITED TO, DAMAGES FOR LOSS OF GOODWILL, LOSS OF REVENUE OR PROFIT, WORK STOPPAGE, COMPUTER FAILURE OR MALFUNCTION, FAILURE OF OTHER EQUIPMENT OR COMPUTER PROGRAMS TO WHICH D-LINK'S PRODUCT IS CONNECTED WITH, LOSS OF INFORMATION OR DATA CONTAINED IN, STORED ON, OR INTEGRATED WITH ANY PRODUCT RETURNED TO D-LINK FOR WARRANTY SERVICE) RESULTING FROM THE USE OF THE PRODUCT, RELATING TO WARRANTY SERVICE, OR ARISING OUT OF ANY BREACH OF THIS LIMITED WARRANTY, EVEN IF D-LINK HAS BEEN ADVISED OF THE POSSIBILITY OF SUCH DAMAGES. THE SOLE REMEDY FOR A BREACH OF THE FOREGOING LIMITED WARRANTY IS REPAIR, REPLACEMENT OR REFUND OF THE DEFECTIVE OR NON-CONFORMING PRODUCT. THE MAXIMUM LIABILITY OF D-LINK UNDER THIS WARRANTY IS LIMITED TO THE PURCHASE PRICE OF THE PRODUCT COVERED BY THE WARRANTY. THE FOREGOING EXPRESS WRITTEN WARRANTIES AND REMEDIES ARE EXCLUSIVE AND ARE IN LIEU OF ANY OTHER WARRANTIES OR REMEDIES, EXPRESS, IMPLIED OR STATUTORY.

Governing Law: This Limited Warranty shall be governed by the laws of the State of California. Some states do not allow exclusion or limitation of incidental or consequential damages, or limitations on how long an implied warranty lasts, so the foregoing limitations and exclusions may not apply. This Limited Warranty provides specific legal rights and you may also have other rights which vary from state to state.

Trademarks: D-Link is a registered trademark of D-Link Systems, Inc. Other trademarks or registered trademarks are the property of their respective owners.

Copyright Statement: No part of this publication or documentation accompanying this product may be reproduced in any form or by any means or used to make any derivative such as translation, transformation, or adaptation without permission from D-Link Corporation/D-Link Systems, Inc., as stipulated by the United States Copyright Act of 1976 and any amendments thereto. Contents are subject to change without prior notice. Copyright 2004 by D-Link Corporation/D-Link Systems, Inc. All rights reserved.

CE Mark Warning: This is a Class A product. In a residential environment, this product may cause radio interference, in which case the user may be required to take adequate measures.

FCC Statement: This equipment has been tested and found to comply with the limits for a Class A digital device, pursuant to part 15 of the FCC Rules. These limits are designed to provide reasonable protection against harmful interference in a commercial installation. This equipment generates, uses, and can radiate radio frequency energy and, if not installed and used in accordance with the instructions, may cause harmful interference to radio communication. However, there is no guarantee that interference will not occur in a particular installation. Operation of this equipment in a residential environment is likely to cause harmful interference to radio or television reception. If this equipment does cause harmful interference to radio or television reception, which can be determined by turning the equipment off and on, the user is encouraged to try to correct the interference by one or more of the following measures:

- Reorient or relocate the receiving antenna.
- Increase the separation between the equipment and receiver.
- Connect the equipment into an outlet on a circuit different from that to which the receiver is connected.
- Consult the dealer or an experienced radio/TV technician for help.

For detailed warranty information applicable to products purchased outside the United States, please contact the corresponding local D-Link office.

Product Registration

Register your D-Link product online at <http://support.dlink.com/register/>

Product registration is entirely voluntary and failure to complete or return this form will not diminish your warranty rights.

Technical Support

U.S. and Canadian customers

This guide is only for initial configuration. Please refer to the user manual to learn more or visit <http://www.mydlink.com> for more information. Also feel free to contact us. U.S. and Canadian customers can contact D-Link Technical Support through our website.

USA

<http://support.dlink.com>

Canada

<http://support.dlink.ca>

Europe customers

TECHNICAL SUPPORT	dlink.com/support
TECHNISCHE UNTERSTÜTZUNG	
ASSISTANCE TECHNIQUE	
ASISTENCIA TÉCNICA	
SUPPORTO TECNICO	
TECHNISCHE ONDERSTEUNING	
POMOC TECHNICZNA	
TECHNICKÁ PODPORA	
TECHNICKÁ PODPORA	
TECHNIKAI TÁMOGATÁS	
TEKNISK SUPPORT	
TEKNISK SUPPORT	
TEKNISK STØTTE	
TEKNINEN TUKI	
ASSISTÊNCIA TÉCNICA	
ΤΕΧΝΙΚΗ ΥΠΟΣΤΗΡΙΞΗ	
TEHNIČKA PODRŠKA	
TEHNIČNA PODPORA	
SUPPORT TEHNIC	
ТЕХНИЧЕСКА ПОДДРЪЖКА	

Australia customers

Tel: 1300-766-868

24/7 Technical Support

Web: <http://www.dlink.com.au>

E-mail: support@dlink.com.au

India customers

Tel: +91-832-2856000

Toll Free 1800-233-0000

Web: www.dlink.co.in

E-Mail: helpdesk@dlink.co.in

Singapore, Thailand, Indonesia, Malaysia, Philippines,

Vietnam customers

Singapore - www.dlink.com.sg

Thailand - www.dlink.co.th

Indonesia - www.dlink.co.id

Malaysia - www.dlink.com.my

Philippines - www.dlink.com.ph

Vietnam - www.dlink.com.vn

Korea customers

Tel : +82-2-2028-1810

Monday to Friday 9:00am to 6:00pm

Web : <http://d-link.co.kr>

E-mail : g2b@d-link.co.kr

New Zealand customers

Tel: 0800-900-900

24/7 Technical Support

Web: <http://www.dlink.co.nz>

E-mail: support@dlink.co.nz

South Africa and Sub Sahara Region customers

Tel: +27 12 661 2025

08600 DLINK (for South Africa only)

Monday to Friday 8:30am to 9:00pm South Africa Time

Web: <http://www.d-link.co.za>

E-mail: support@d-link.co.za

D-Link Middle East - Dubai, U.A.E. customers

Plot No. S31102,

Jebel Ali Free Zone South,

P.O.Box 18224, Dubai, U.A.E.

Tel: +971-4-8809022

Fax: +971-4-8809066 / 8809069

Technical Support: +971-4-8809033

General Inquiries: info.me@dlinkmea.com

Tech Support: support.me@dlinkmea.com

Egypt customers

1, Makram Ebeid Street -

City Light Building - floor 5

Nasrcity - Cairo, Egypt

Tel.: +2 02 23521593 - +2 02 23520852

Technical Support: +2 02 26738470

General Inquiries: info.eg@dlinkmea.com

Tech Support: support.eg@dlinkmea.com

Kingdom of Saudi Arabia customers

Office # 84 ,

Al Khaleej Building (Mujamathu Al-Khaleej)

Opp. King Fahd Road, Olaya

Riyadh - Saudi Arabia

Tel: +966 1121 70008

Technical Support:

+966 1121 70009

General Inquiries: info.sa@dlinkmea.com

Tech Support: support.sa@dlinkmea.com

Pakistan customers

Islamabad Office:

61-A, Jinnah Avenue, Blue Area,
Suite # 11, EBC, Saudi Pak Tower,
Islamabad - Pakistan

Tel.: +92-51-2800397, 2800398

Fax: +92-51-2800399

Karachi Office:

D-147/1, KDA Scheme # 1,
Opposite Mudassir Park, Karsaz Road,
Karachi – Pakistan

Phone: +92-21-34548158, 34326649

Fax: +92-21-4375727

Technical Support: +92-21-34548310, 34305069

General Inquiries: info.pk@dlinkmea.com

Tech Support: support.pk@dlinkmea.com

Iran customers

Unit 5, 5th Floor, No. 20, 17th Alley , Bokharest St. , Argentine Sq. ,
Tehran IRAN

Postal Code : 1513833817

Tel: +98-21-88880918,19

+98-21-88706653,54

General Inquiries: info.ir@dlinkmea.com

Tech Support: support.ir@dlinkmea.com

Morocco customers

M.I.T.C

Route de Nouaceur angle RS et CT 1029 Bureau N° 312 ET 337

Casablanca , Maroc

Phone : +212 663 72 73 24

Email: support.na@dlinkmea.com

Lebanon RMA center customers

Dbayeh/Lebanon

PO Box:901589

Tel: +961 4 54 49 71 Ext:14

Fax: +961 4 54 49 71 Ext:12

Email: taoun@dlinkmea.com

Bahrain customers

Technical Support: +973 1 3332904

Kuwait customers

Technical Support: + 965 22453939 / +965 22453949

Türkiye customers

Büyükdere Cad. Ferro Plaza No:155

D: 1 K: 1 Zincirlikuyu / Istanbul

Tel: +90 (212) 289-56-59

Email: info.tr@dlink.com.tr

לארשי

רטנס וולטמ

20 מימישגמה 'חר

7060 ד"ת, 49348 ת"פ, וולטמ תירק

לט: 03-9215173

לט: 073-7962797

יילכ ל"אוד: info@dlink.co.il

הכימת ל"אוד: support@dlink.co.il

Техническая Поддержка

Обновления программного обеспечения и документация доступны на Интернет-сайте D-Link. D-Link предоставляет бесплатную поддержку для клиентов в течение гарантийного срока. Клиенты могут обратиться в группу технической поддержки D-Link по телефону или через Интернет.

Техническая поддержка компании D-Link работает в круглосуточном режиме ежедневно, кроме официальных праздничных дней. Звонок бесплатный по всей России.

Техническая поддержка D-Link:
8-800-700-5465

Техническая поддержка через Интернет:
<http://www.dlink.ru>
e-mail: support@dlink.ru

Офисы

Россия

Москва, Графский переулок, 14

Тел. : +7 (495) 744-00-99

E-mail: mail@dlink.ru

Україна

Київ, вул. Межигірська, 87-А

Тел.: +38 (044) 545-64-40

E-mail: ua@dlink.ua

Moldova

Chisinau; str.C.Negruzzi-8

Tel:+373(22) 80-81-07

E-mail:info@dlink.md

Беларусь

Мінск, пр-т Незалежнасці, 169

Тэл.: +375 (17) 218-13-65

E-mail: support@dlink.by

Қазақстан

Алматы, қ. Құрманғазы, 143 үй

Тел.: +7 (727) 378-55-90

E-mail: almaty@dlink.ru

Հայաստան

Երևան, Դավթաշեն 3-րդ

թաղամաս, 23/5

Հեռ.՝ +374 (10) 39-86-67

Էլ. փոստ՝ info@dlink.am

საქართველო

თბილისი, მარიჯანის ქუჩა N4

ტელ.: +995 (032) 220-77-01

E-mail: info@dlink.ge

Latvija

Rīga, Lielirbes iela 27

Tel.: +371 (6) 761-87-03

E-mail: info@dlink.lv

Lietuva

Vilnius, Žirmūnų 139-303

Tel.: +370 (5) 236-36-29

E-mail: info@dlink.lt

Eesti

E-mail: info@dlink.ee

Soporte Técnico Para Usuarios En Latino America

Por favor revise el número telefónico del Call Center de su país en <http://www.dlinkla.com/soporte/call-center>

Soporte Técnico de D-Link a través de Internet

Horario de atención Soporte Técnico en www.dlinkla.com

e-mail: soporte@dlinkla.com & consultas@dlinkla.com

Cientes de Brasil

Caso tenha dúvidas na instalação do produto, entre em contato com o Suporte Técnico D-Link.

Acesse o site: **www.dlink.com.br/suporte**

D-Link 友訊科技 台灣分公司 技術支援資訊

如果您還有任何本使用手冊無法協助您解決的產品相關問題，台灣地區用戶可以透過我們的網站、電子郵件或電話等方式與D-Link台灣地區技術支援工程師聯絡。

D-Link 免付費技術諮詢專線

0800-002-615

手機付費電話 (02)6600-0123#8715

服務時間：週一至週五，早上9:00到晚上9:00

週六日及國定假日(不含農曆春節) 早上10:00到晚上7:00

網 站：<http://www.dlink.com.tw>

電子郵件：dssqa_service@dlink.com.tw

如果您是台灣地區以外的用戶，請參考D-Link網站，全球各地分公司的聯絡資訊以取得相關支援服務。

產品保固期限、台灣區維修據點查詢，請參考以下網頁說明：

<http://www.dlink.com.tw>

產品維修：

使用者可直接送至全省聯強直營維修站或請洽您的原購買經銷商。

Pelanggan Indonesia

Update perangkat lunak dan dokumentasi pengguna dapat diperoleh pada situs web D-Link.

Dukungan Teknis untuk pelanggan:

Tel: +62-21-5731610

Dukungan Teknis D-Link melalui Internet:

Email : support@dlink.co.id

Website : <http://support.dlink.co.id>

日本のお客様

この度は弊社製品をお買い上げいただき、誠にありがとうございます。

製品に同梱されている保証書の購入元にお問い合わせください。

中国客户

办公地址：北京市朝阳区将台路5号院5号楼 邮编：100016

技术支持中心电话：400-629-6688

技术支持中心传真：(028)-61317620

各地维修中心地址请登陆官方网站查询

网址：<http://www.dlink.com.cn>

400电话工作时间：工作日9:00-19:00；节假日9:00-18:00

Registration Card

All Countries and Regions Excluding USA

Print, type or use block letters.

Your name: Mr./Ms _____

Organization: _____ Dept. _____

Your title at organization: _____

Telephone: _____ Fax: _____

Organization's full address: _____

Country: _____

Date of purchase (Month/Day/Year): _____

Product Model	Product Serial No.	* Product installed in type of computer	* Product installed in computer serial No.

(* Applies to adapters only)

Product was purchased from:

Reseller's name: _____

Telephone: _____

Answers to the following questions help us to support your product:

1. Where and how will the product primarily be used?

Home Office Travel Company Business Home Business Personal Use

2. How many employees work at installation site?

1 employee 2-9 10-49 50-99 100-499 500-999 1000 or more

3. What network protocol(s) does your organization use ?

XNS/IPX TCP/IP DECnet Others _____

4. What network operating system(s) does your organization use ?

D-Link LANsmart Novell NetWare NetWare Lite SCO Unix/Xenix PC NFS 3Com 3+Open Cisco Network
Banyan Vines DECnet Pathwork Windows NT Windows 98 Windows 2000/ME Windows XP
Others _____

5. What network management program does your organization use ?

D-View HP OpenView/Windows HP OpenView/Unix SunNet Manager Novell NMS
NetView 6000 Others _____

6. What network medium/media does your organization use ?

Fiber-optics Thick coax Ethernet Thin coax Ethernet 10BASE-T UTP/STP
100BASE-TX 1000BASE-T Wireless 802.11b and 802.11g wireless 802.11a Others _____

7. What applications are used on your network?

Desktop publishing Spreadsheet Word processing CAD/CAM
Database management Accounting Others _____

8. What category best describes your company?

Aerospace Engineering Education Finance Hospital Legal Insurance/Real Estate Manufacturing
Retail/Chain store/Wholesale Government Transportation/Utilities/Communication VAR
System house/company Other _____

9. Would you recommend your D-Link product to a friend?

Yes No Don't know yet

10. Your comments on this product?

PLEASE
PLACE STAMP
HERE

TO:

D-Link®