

DPH-400SE
VERSION 1.00

USER MANUAL



D-Link[®]

VOIP



Safety Notices

Please read the following safety notices before installing or using this phone. They are crucial for the safe and reliable operation of the device.

- Please use the external power supply that is included in the package. Other power supplies may cause damage to the phone, affect the behavior or induce noise.
- Before using the external power supply in the package, please check with home power voltage. Inaccurate power voltage may cause fire and damage.
- Please do not damage the power cord. If power cord or plug is impaired, do not use it, it may cause fire or electric shock.
- The plug-socket combination must be accessible at all times because it serves as the main disconnecting device.
- Do not drop, knock or shake it. Rough handling can break internal circuit boards.
- Do not install the device in places where there is direct sunlight. Also do not put the device on carpets or cushions. It may cause fire or breakdown.
- Avoid exposure the phone to high temperature, below 0°C or high humidity. Avoid wetting the unit with any liquid.
- Do not attempt to open it. Non-expert handling of the device could damage it. Consult your authorized dealer for help, or else it may cause fire, electric shock and breakdown.
- Do not use harsh chemicals, cleaning solvents, or strong detergents to clean it. Wipe it with a soft cloth that has been slightly dampened in a mild soap and water solution.
- When lightning, do not touch power plug or phone line, it may cause an electric shock.
- Do not install this phone in an ill-ventilated place.
- You are in a situation that could cause bodily injury. Before you work on any equipment, be aware of the hazards involved with electrical circuitry and be familiar with standard practices for preventing accidents.

Table of Content

1. INTRODUCING DPH-400SE VOIP PHONE.....	5
1.1. THANK YOU FOR YOUR PURCHASING DPH-400SE.....	5
1.2. DELIVERY CONTENT	5
1.3. KEYPAD	5
1.4. PORT FOR CONNECTING.....	6
2. INITIAL CONNECTING AND SETTING.....	7
2.1. CONNECT THE PHONE	7
2.1.1. <i>Connect to network</i>	7
2.1.2. <i>Power adaptor connection</i>	8
2.2. BASIC INITIALIZATION	8
2.2.1. <i>Network settings</i>	8
3. DPH-400SE'S BASIC OPERATION.....	9
3.1. ANSWER CALLS.....	9
3.2. PLACE CALLS.....	10
3.3. END CALLS.....	10
3.4. CALL TRANSFER	11
3.5. CALL HOLD.....	11
3.6. 3-WAY CONFERENCE CALL.....	11
3.7. SWITCHBOARD OPERATOR FEATURE.....	11
3.8. CALL RECORDS.....	11
4. WEB CONFIGURATION	12
4.1. INTRODUCTION OF CONFIGURATION.....	12
4.1.1. <i>Ways to configure</i>	12
4.1.2. <i>Password Configuration</i>	12
4.2. SETTING VIA WEB BROWSER	13
4.3. CONFIGURATION VIA WEB	13
4.3.1. <i>BASIC</i>	13
4.3.1.1. Status.....	13
4.3.1.2. Wizard.....	14
4.3.1.3. Call Log.....	15
4.3.1.4. MMI SET	16
4.3.2. Network.....	16
4.3.2.1. WAN Config.....	16
4.3.2.2. LAN Config.....	18
4.3.2.3. QoS Config	18
4.3.2.4. Service Port.....	21
4.3.2.5. DHCP SERVER.....	22
4.3.2.6. SNTP	23
4.3.3. VOIP	24
4.3.3.1. SIP Config.....	24
4.3.3.2. Stun Config	28
4.3.3.3. DIAL PEER setting.....	29
4.3.4. <i>Phone</i>	32
4.3.4.1. <i>DSP Config</i>	32
4.3.4.2. Call Service.....	33
4.3.4.3. Digital Map Configuration	35
4.3.4.4. Phone Book	36
4.3.4.5. Function Key.....	37
4.3.5. <i>Maintenance</i>	38
4.3.5.1. <i>Auto Provision</i>	38
4.3.5.2. Syslog Config.....	39
4.3.5.3. Config Setting.....	40
4.3.5.4. Update.....	41
4.3.5.5. Account Config.....	42
4.3.5.6. Reboot	43

4.3.6. Security	43
4.3.6.1. MMI Filter	43
4.3.6.2. Firewall	44
4.3.6.3. NAT Config	46
4.3.6.4. VPN Config	48
4.3.7. Logout	49
5. CONFIGURATION VIA KEYPAD	50
5.1. Keypad introduction	50
5.2. Menu Tree	50
6. APPENDIX	51
6.1. SPECIFICATION	51
6.1.1. HARDWARE	51
6.1.2. VOICE FEATURES	51
6.1.3. NETWORK FEATURES	52
6.1.4. MAINTENANCE AND MANAGEMENT	52
6.1.5. SPECIAL FEATURES	52
6.2. DIGIT-CHARACTER MAP TABLE	52

1. Introducing DPH-400SE VoIP Phone

1.1. Thank you for your purchasing DPH-400SE

Thank you for your purchasing DPH-400SE, DPH-400SE is a full-feature telephone that provides voice communication over the same data network that your computer uses. This phone functions not only much like a traditional phone, allowing to place and receive calls, and enjoy other features that traditional phone has, but also it own many data services features which you could not expect from a traditional telephone. This guide will help you easily use the various features and services available on your phone.

1.2. Delivery Content

Please check whether the delivery contains the following parts:

The base unit with display and keypad

The handset

The handset cable







The power supply











The Ethernet cable

The User Manual (you may download from our [website](#))

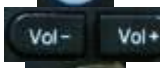





IP Phone are designed to look like conventional phones, the following photo shows a broad overview of the IP Phone.

1.3. Keypad

Key	Key name	Function Description
	Navigation	Navigation key assist users for operating... In idle state they have special function Left: Checking Incoming call Up: Checking Missed Call Right: Checking line status Down: Checking IP info OK: Enter into the phone's menu
	Release key	Press RLS, the phone will skip to stand-by mode. Note: DO NOT Press RLS during the configuration process, or else phone will not save the configuration modified and return to stand-by status.
	Phone Book	Access to phone book, check the record list and add new records and revise the record. When check the phone book record, press this key again will return to idle mode.
	Envelope	LED inside, if blinks remind user have new voicemail.
	Hold	Temporarily hold the active call during the talking; press the key again might release the call. (Please refer to 3.5. - call hold for more details) . In idle mode, press this key, LCD will show "Do Not Disturb", and this phone is set to be No disturbing mode. Press this key again to cancel this function.
	Transfer	Use the key to realize blind transfer or attended transfer please refers to 3.4.-call transfer for more details) . In the idle mode, press this key, LCD will show"call forward". After this indication disappears, User can configure the forward phone no. of SIP1 or SIP2. Press Soft2(ON) to enabled call forward function and set it to always mode; Press Soft1(OFF) to close the function of forward

	mute	Press this key in calling mode, you can hear the other side, and the other side can not hear you Here is Three SIP lines, user could select any one to make the call ,if it has been registered
	Line1/2/3	
		
		
	Volume +/-	Turn down or turn up the volume by pressing these two keys
	Redial	1,In the hook off /hands-free mode, use the key to dial the last call number; 2,In stand-by mode, it has a function to check the OUTGOING CALL Make the phone into hands-free mode.
	Hands-free	
	Indicator light	If the light blinking, indicate the phone has missed call
	Memory key (1-6)	Users could store their commonly used number in these keys, and call for them as speed dial.
	Soft key 1/2/3	Keys combination, include functions such as SMS / SDial /Memo /Answer /Conf /enter /save / quit /edit /redial / and so on.

1.4. Port for connecting

Port	Port name	description
	Power switch	Input: 5V AC, 1A
	WAN	10/100M Connect it to Network
	LAN	10/100M Connect it to PC
	Handset	Port type: RJ-9 connector
	Headset	Port type: RJ-9 connector
	Headset	Port type: 3.5mm jack

DPH-400SE provide two Ethernet ports and a power adaptor. Also has two headset interfaces with R J-9 port and 3.5mm jack. Please refer to safety notes of this manual carefully before power adaptor is connected.

2. Initial connecting and Setting

2.1. Connect the phone

2.1.1. Connect to network

Step 1: Connect the IP Phone to the corporate IP telephony network. Before you connect the phone to the network, please check if your network can work normally.

You can do this in one of two ways, depending on how your workspace is set up.

Direct network connection—by this method, you need at least one available Ethernet port in your workspace. Use the Ethernet cable in the package to connect WAN port on the back of your phone to the Ethernet port in your workspace. Since this VoIP Phone has router functionality, whether you have a broadband router or not, you can make direct network connect. The following two figures are for your reference.

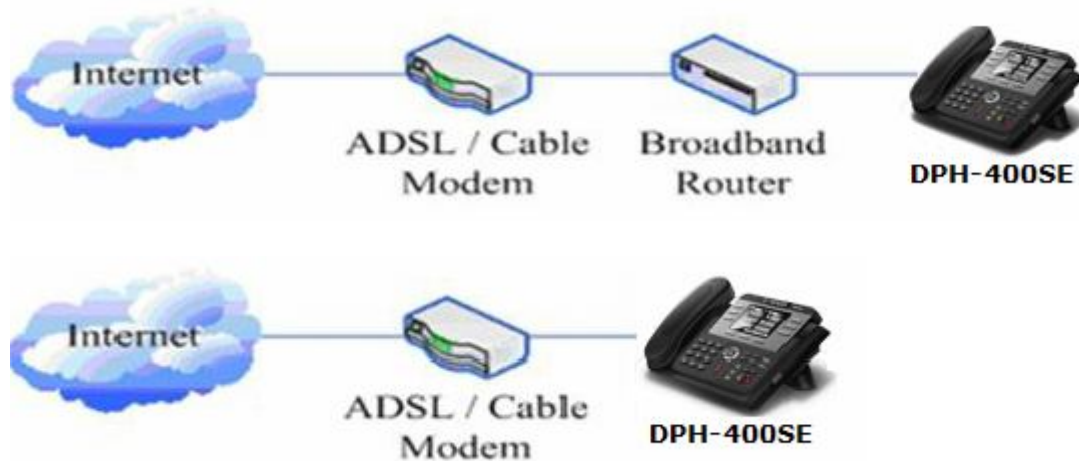

Shared network connection—Use this method if you have a single Ethernet port in your workspace with your desktop computer already connected to it. First, disconnect the Ethernet cable from the computer and attach it to the WAN port on the back of your phone. Next, use the Ethernet cable in the package to connect LAN port on the back of your phone to your desktop computer. Your IP Phone now shares a network connection with your computer. The following figure is for your reference.

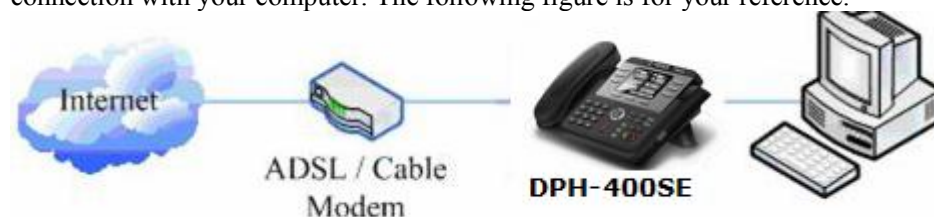

Step 2: Connect the handset to the handset port by the handset cable in the package.

Step 3: connect the power supply plug to the AC 5V adaptor port on the back of the phone. Use the power cable to connect the power supply to a standard power outlet in your workspace.

Step 4: push the on/off switch on the back of the phone to the on side, then the phone's LCD screen displays "Initializing wait logon". Later, a ready screen typically displays the date, time.

If your LCD screen displays different information from the above, you need refer to the next section "Initial setting" to set your network online mode.

If your VoIP phone registers into corporate IP telephony Server, your phone is ready to use.

2.1.2. Power adaptor connection

Make sure that the power you use is comply with the parameters of power adaptor.

1. Plug power adaptor to power socket.
2. Plug power adaptor's AC output to the AC5V port of DPH-400SE to start up.
3. There will be displayed black line and "initializing... wait logon..." on the screen. After finishing startup, phone will show greeting, current date and time and so forth.
4. If phone has registered to the server, you can place or answer calls.

2.2. Basic Initialization

DPH-400SE is provided with a plenty of functions and parameters for configuration. User needs some network and VoIP knowledge so that user could understand the meanings of parameters. In order to make user use the phone more easily and convenient, there are basic configurations introduced which is mandatory to ensure phone calls.





2.2.1. Network settings

Make sure that network is connected already before setting network of phone. DPH-400SE uses DHCP to get WAN IP configurations, so phone could access to network as long as there is DHCP server in it. If there is no DHCP server available, phone has to be changed WAN network setting to Static IP or PPPoE.

Note: during setting network parameter in menu, Please don't press the  key, or else the phone will not save the configuration and will return to standby interface.

Setting PPPoE mode (for ADSL connection)





1. Get PPPoE account and password first.

2. Press , and press  twice, screen will show "Network". Then press Soft2 (Enter) or "OK", the LCD screen will display "WAN".
3. Press Soft2 (Enter), then press , choose **PPPoE**.
4. Press Soft1 (Edit), the screen will display "Account". The screen will show the current account information. Press Soft1 (Del) to delete it, then input your PPPoE account and press Soft2 (Save). With "saved" displayed, screen will jump to **password** settings,
5. Press Soft2 (Edit) again, then input your PPPoE password and press Soft2 (OK), With "Saved" displayed, screen will display the current **password: *******, and **confirm:** you need input the password again, after confirm, press soft2 (OK) to save the Account and password.
6. Press Soft3 (Quit) once return to "Net Mode". Press Soft2 (Save) the screen will show "Saved" and then jump to show the current net mode.
7. Press  or Soft3 (Quit) thrice return to standby, at this time the phone is trying to change to PPPoE mode. Press  for checking the status. If the screen shows "Negotiating..." it shows that the phone is trying to access to the PPPoE Server; if it shows an IP address, then the phone has already get IP with PPPoE.





Setting Static IP mode (static ADSL/Cable, or no PPPoE / DHCP network)

1. Prepare the network's parameters first, such as IP Address, Net mask, Default Gateway and DNS server IP address. If you don't know this information, please contact the service provider or technician of

network.

2. Press , then press  twice, chooses “**Network**”. Press "OK" or Soft2 (Enter), LCD screen will display “**WAN**”.
3. Press "OK" or Soft2 (Enter), then choose “**Static**”.
4. Press Soft1(Edit) and screen will show “**IP**”, then press Soft1 (Del) to delete. Input your IP address and press Soft2 (Save) to save what you input. After “**Saved**” shown, the screen will jump to show the **Net mask** information.
5. Press Soft1 (Del) to delete. Input your Net mask and press Soft2 (Save). After “**Saved**” shown, the screen will jump to show the Gateway information
6. Press Soft1 (Del) to delete, Input your gateway and press Soft2 (Save). After “**Saved**” shown, the screen will jump to show the DNS information.
7. Press Soft1 (Del) to delete. Input your DNS server address and press Soft2 (Save). After “**Saved**” shown, the screen will return to show IP information.
8. Press Soft3 (Quit) once, the screen shows” **Net Mode**”. the cursor stay at“<>**Static**”; with Soft2(Save) pressed, “**Saved**” and then shows the current net mode.
9. Press  or Soft3 (Quit) thrice, return to main interface and at this time the phone is trying to change to Static mode. Press  button, the screen shows “**Static**” .the screen shows the IP address and gateway which were set just now, if the phone could display the right time, it shows that Static IP mode takes effect.

Setting DHCP mode

1. Press , then press  twice, chooses “**Network**”. Then press "OK" or Soft2 (Enter), the screen will show “**WAN**”.
2. Press "OK" or Soft2 (Enter) to show “**Net Mode**”. Select “**DHCP**”. Press Soft2 (Save), with “**saved**” shown, screen will jump to show the current net mode.
3. Press  or Soft3 (Quit) thrice back to main interface and at this time phone is trying to change to DHCP mode. Press  until the phone shows “**DHCP**”, If the screen shows the IP address and gateway which were set just now, it shows that DHCP mode takes effect.

3. DPH-400SE’s basic operation



3.1. Answer calls

DPH-400SE will ring to indicate you when there is call incoming, below is ways to answer call:



- Answer with hook off

Take handset, you can talk directly. You can just hang up to finish talk.

- Answer with hands-free



Press  to begin talking. Press  again to finish talk

- Answer with headset

Press  to answer the call, if the phone detect headset LED will turn to green, when you press 

again the phone change to speaker mode. You may press  or Soft3 (Close) to finish the call.

- Using hands-free instead of handset during a talk

Press  and hook on the handset when you use handset to speak and want to change to use hands-free to speak. Press  again to finish talk.

- Using handset instead of hands-free during a talk

Hook off the handset when you want to use hands-free to speak and want to change to use handset. Just hook on to finish talk.

3.2. Place calls

- Using handset





Hook off (screen will show the current using line, or you could press key L1-L3 to select), after getting dialing tone, you could begin to dial number. After finishing it, press # and DPH-400SE will send the number and call the number. When you hear a ring-back tone and screen shows the callee's number, it shows that the person you called is ringing. If callee answers the call, you can begin to talk and your phone will keep showing callee's number and counting time. Just hang up to finish talk.

- Using hands-free

Press  (screen will show the current using line, or you could press key L1-L3 to select), after getting dialing tone, you could begin to dial number. After finishing it, press # and DPH-400SE will send the number and call the number. When you hear a ringback tone and screen shows the callee's number, it shows that the person you called is ringing. If callee answers the call, you can begin to talk and your phone will

keep showing callee's number and counting time. Press  again to finish talk.

- Using directory

Press  in stand-by mode, you will access to phonebook. If there are many persons records stored in the directory, you can use  &  to select number or press the first character of the name for searching the person which you want to contact. Press  to forward, and press  to backward. Press Soft2 (Dial) to dial the current number shown on the screen.

- Speed dial

Speed dial means user can make calls directly without hook off or using hands-free. User can dial number in stand-by mode, but first, user need to add and edit SDial no. By pressing Soft2 (SDial) to edit and save the number to be a SDial number. In this way, user could make a call only press the number and Soft3 (Dial).

- Multi-line calls

DPH-400SE supports 3 SIP lines, that is user could use 3 SIP accounts to register and make calls. System will use SIP 1 as default line to call.

There are most two calls at the same time. Screen will display the incoming call number when user is keep talking. You can press Soft1 (Answer) to accept it, and hold the first one (if you want to use this function, you need enable Call Waiting of the phone first). Use Soft1 (Switch) to switch the two calls to talk.

3.3. End calls

- Hang up with handset hook on

Hook on to finish talking.

- Hang up with hands-free

Press  to finish talk when phone is in hands-free status.

Note: user can not finish talk by pressing  if phone is used handset to talk.

- Hang up a active call with 2 calls

When there are two calls, user might use Soft1(Switch)to switch to the call you want to hang up first. Then press Soft3 (Close) to finish talk, and phone will switch to the other call automatically.



Note: it is no use to press Soft3(Close) to finish talk, if there is only one current call.

3.4. Call transfer

■ Blind Transfer



During talk, press  or Soft2 (Transf), and then dial the number that you want to transfer to, and finished by "#". Phone will transfer the current call to the third party. After finishing transfer, the call you talk to will be hanged up. User can not select SIP line when phone transfers call.

■ Attended Transfer



During talk, press  or Soft2 (Transf), then input the number that you want to transfer to and press Soft2 (Send). After that third party answers, then press  to complete the transfer. (You need enable call waiting and call transfer first). If there are two calls, you can just talk to one, and keep hold to the other one. The one who is keep hold can not speak to you or hear from you. In other way, if user wants to invite the third party during the call, they can press Soft1 (Conf) to make calls mode in conference mode. If user wants to stop conference, user can press Soft1 (Split). (User must enable call waiting and three way call first).

Note: the server that user uses must support RFC3515 or it might not be used

■ Alert Transfer

During the talk, press  or Soft2 (Transf) firstly, then press Soft2 (Send) after inputting the number that you want to transfer. You are waiting for connection, now, press  or Soft2 (Transf) and the transfer will be done. (To use this feature, you need enable call waiting and call transfer first)

3.5. Call hold

During talking, user could press  to hold the current call. Press  again to return the call or switch the call active.



3.6. 3-way conference call

User can press Soft1 (Conf) to dial the line2 (press Soft1 (Answer) to answer the call directly if this call is from line2) during talking with line1. After line2 connect, user can press Soft2 (Conf) to enter into conference mode. To back to line1 from conference, please press Soft1 (Split); to end the call, please press

Soft3 (Close) or press .

3.7. Switchboard Operator feature



User can press Soft1 (Conf) to dial the line2 (press Soft1 (Answer) to answer the call directly if this call is from line2) during talking with line1. After line2 connect, user can press Soft1 (Switch) to select which line

you prefer to transfer, then press  to input the number you want to transfer and press  again to do the transfer.



3.8. Call records

DPH-400SE supports 100 items of missed call, 100 items of incoming call, and 100 items of dialed call. If the records are full, the newest will replace the oldest. If phone's power cut or reboot, call records will be discarded.



- Missed call

Press , and screen displays “Missed Call” with the number and time of missed call. User can also use  &  to browse the missed call records, or press Soft1 (Option) to check the details of this record, then press Soft2 (EDial) again to change the current number. Pressing Soft2 (Dial) will call this number directly if user don't modify the number. If there is no missed call, screen will show “List Is Empty”.

- Incoming call

Press , and screen displays “Incoming Call”, by pressing  &  to browse the records; or press Soft1 (Option) to check the details of this record, then press Soft2 (EDial) again to change the current number. Pressing Soft2 (Dial) will call this number directly if user don't modify the number. If there is no incoming call, screen will show “List Is Empty”.

- Dialed call

Press , and use  &  to browse the dialed call records; or press Soft1 (Option) to check the details of this record, then press Soft2 (EDial) again to change the current number. Pressing Soft2 (Dial) will call this number directly if user don't modify the number. If there is no dialed call, screen will show “List Is Empty”.

4. Web configuration

4.1. Introduction of configuration

4.1.1. Ways to configure

DPH-400SE has three different ways to different users.

- Use phone keypad.
- Use web browser (recommendatory way) .
- Use telnet with CLI command.

4.1.2. Password Configuration

There are two levels to access to phone: root level and general level. User with root level can browse and set all configuration parameters, while user with general level can set all configuration parameters except SIP (1-3) that some parameters can not be changed, such as server address and port. User will has different access level with different username and password.

- Default user with general level:
 - username: guest
 - ◆ password: guest
- Default user with root level:
 - ◆ username: admin
 - ◆ password: admin

The default password of phone screen menu is 123.

4.2. Setting via web browser

When this phone and PC are connected to network, enter the IP address of the wan port in this phone as the URL (e.g. <http://xxx.xxx.xxx.xxx/> or <http://xxx.xxx.xxx.xxx:xxxx/>).

If you do not know the IP address, you can look it up on the phone's display by pressing  button. The login page is as below picture



Username:

Password:

- : After you configure the ip phone, you need click save button in config under Maintenance in the left catalog to save your configuration. Otherwise the phone will lose your modification after power off and on.

4.3. Configuration via WEB

4.3.1. BASIC

4.3.1.1. Status

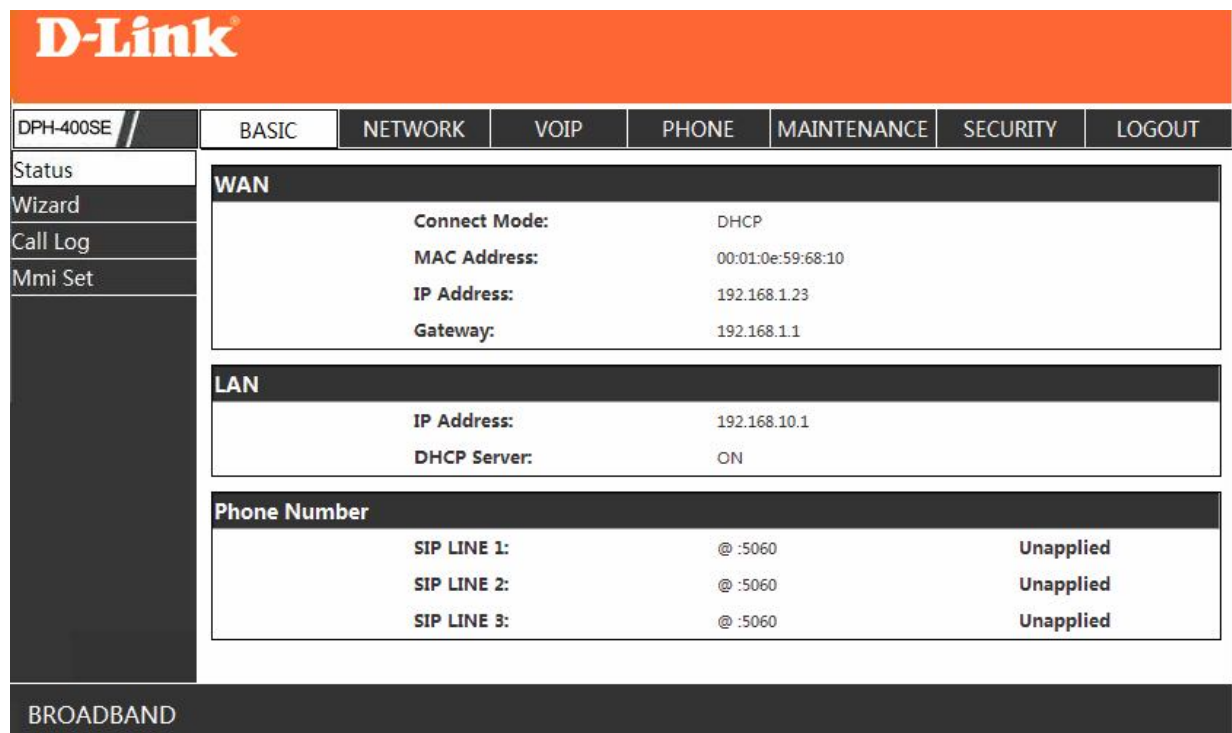

D-Link

DPH-400SE // BASIC NETWORK VOIP PHONE MAINTENANCE SECURITY LOGOUT

Status
Wizard
Call Log
Mmi Set

WAN

Connect Mode:	DHCP
MAC Address:	00:01:0e:59:68:10
IP Address:	192.168.1.23
Gateway:	192.168.1.1

LAN

IP Address:	192.168.10.1
DHCP Server:	ON

Phone Number

SIP LINE 1:	@ :5060	Unapplied
SIP LINE 2:	@ :5060	Unapplied
SIP LINE 3:	@ :5060	Unapplied

BROADBAND

Status

Field name	Explanation
Network	Shows the configuration information on WAN and LAN port, including the connect mode of WAN port (Static, DHCP, PPPoE), MAC address, the IP address of WAN port and LAN port, ON or OFF of DHCP mode of LAN port.
Phone Number	Shows the phone numbers provided by the SIP LINE 1-3 servers The last line shows the version number and issued date.

4.3.1.2. Wizard

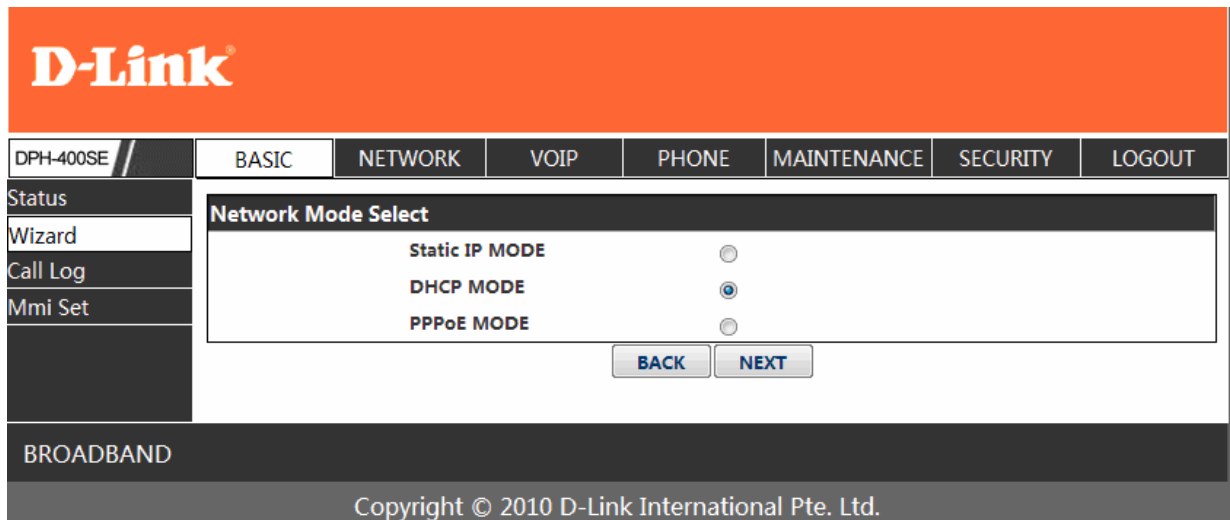

Wizard

Field Name	Explanation
Network Mode Select	
Static IP MODE	<input type="radio"/>
DHCP MODE	<input checked="" type="radio"/>
PPPoE MODE	<input type="radio"/>

Please select the proper network mode according to the network condition. DPH-400SE provide three different network settings:

- Static: If your ISP server provides you the static IP address, please select this mode, then finish Static Mode setting. If you don't know about parameters of Static Mode setting, please ask your ISP for them.
- DHCP: In this mode, you will get the information from the DHCP server automatically; need not to input this information artificially.
- PPPoE: In this mode, your must input your ADSL account and password.

You can also refer to 3.2.1 Network setting to speed setting your network.

Choose Static IP MODE, click **【NEXT】** can config the network and SIP(default SIP1) simply, also can browse too. Click **【BACK】** can return to the last page.

Static IP Set	
Static IP Address	192.168.1.179
Netmask	255.255.255.0
Gateway	192.168.1.1
DNS Domain	
Primary DNS	202.96.134.133
Alter DNS	202.96.128.68

Static IP Address	Input the IP address distributed to you.
Net mask	Input the Net mask distributed to you.
Gateway	Input the Gateway address distributed to you.
DNS Domain	Set DNS domain postfix. When the domain which you input can not be parsed, phone will automatically add this domain to the end of the domain which you input before and parse it again.
Primary DNS	Input your primary DNS server address.
Alter DNS	Input your standby DNS server address.

Simple SIP Set	
Display Name	<input type="text"/>
Server Address	192.168.1.2
Server Port	5060
User Name	2113
Password	••••
Phone Number	2113
Enable Register	<input checked="" type="checkbox"/>

Display Name	Set the display name.
Server Address	Input your SIP server address.
Server Port	Set your SIP server port.
User Name	Input your SIP register account name.
Password	Input your SIP register password.
Phone Number	Input the phone number assigned by your VOIP service provider.
Enable Register	Start to register or not by selecting it or not.

WAN	
Connect Mode	STATIC
Static IP Address	192.168.1.179
Gateway	192.168.1.1

SIP	
Register Server	192.168.1.2
User Name	2113
PhoneNumber	2113
Register	ON

Display detailed information that you manual config.

Choose DHCP MODE, click【NEXT】can config SIP(default SIP1)simply, also can browse too.

Click 【BACK】 can return to the last page. Like Static IP MODE。

Choose PPPoE MODE, click【NEXT】can config the PPPoE account/password and SIP(default SIP1)simply, also can browse too. Click 【BACK】 can return to the last page. Like Static IP MODE。

PPPOE Set	
PPPOE Server	ANY
Username	user123
Password	••••••••

PPPoE Server It will be provided by ISP.

Username Input your ADSL account.

Password Input your ADSL password.

Notice: Click 【Finish】 button after finished your setting, IP Phone will save the setting automatically and reboot, After reboot, you can dial by the SIP account.

4.3.1.3. Call Log

You can query all the outgoing through this page.

Call Log

Field name	explanation
Start Time	Display the start time of the outgoing record.
Last Time	Display the conversation time of the outgoing record.
Called Number	Display the account/protocol/line of the outgoing record.

4.3.1.4. MMI SET

MMI SET

Field name	explanation
Language Set	Set the language of phone, English is default.
Greeting Message	The greeting message will display on lcd when phone is idle. It can support 16 chars. the default chars are VOIP PHONE.

4.3.2. Network

4.3.2.1. WAN Config

WAN Config

Field Name	explanation
------------	-------------

WAN Status	
Active IP:	192.168.1.23
Current Netmask:	255.255.255.0
Current Gateway:	192.168.1.1
MAC Address:	00:01:0e:59:68:10
Get MAC Time:	2010-5-4

Active IP	The current IP address of the phone.
Current Net mask	The current Net mask address.
MAC Address	The current MAC address of the phone.
Current Gateway	The current Gateway IP address.
Get MAC Time	Shows the time of getting MAC address

WAN Setting		
<input type="radio"/> Static	<input checked="" type="radio"/> DHCP	<input type="radio"/> PPPOE
<input checked="" type="checkbox"/> obtain DNS server automatically		

Please select the proper network mode according to the network condition. DPH-400SE provide three different network settings:

- **Static:** If your ISP server provides you the static IP address, please select this mode, then finish Static Mode setting. If you don't know about parameters of Static Mode setting, please ask your ISP for them.
- **DHCP:** In this mode, you will get the information from the DHCP server automatically; need not to input this information artificially.
- **PPPoE:** In this mode, your must input your ADSL account and password. You can also refer to 3.2.1 Network setting to speed setting your network.

Obtain DNS server automatically Select it to use DHCP mode to get DNS address, if you don't select it, you will use static DNS server. The default is selecting it.

Static IP Address:	192.168.1.179
Netmask:	255.255.255.0
Gateway:	192.168.1.1
DNS Domain:	
Primary DNS:	202.96.134.133
Alter DNS:	202.96.128.68

If you use static mode, you need set it.

IP Address	Input the IP address distributed to you.
Net mask	Input the Net mask distributed to you.
Gateway	Input the Gateway address distributed to you.
DNS Domain	Set DNS domain postfix. When the domain which you input can not be parsed, phone will automatically add this domain to the end of the domain which you input before and parse it again.
Primary DNS	Input your primary DNS server address.
Alter DNS	Input your standby DNS server address.

PPPOE Server:	ANY
Username:	user123
Password:	●●●●●●

If you uses PPPoE mode, you need to make the above setting.

PPPoE Server	It will be provided by ISP.
Username	Input your ADSL account.
Password	Input your ADSL password.

Notice:

- 1) Click “Apply” button after finished your setting, IP Phone will save the setting automatically and new setting will take effect.
- 2) If you modify the IP address, the web will not response by the old IP address. Your need input new IP address in the address column to logon in the phone.
- 3) If networks ID which is DHCP server distributed is same as network ID which is used by LAN of system, system will use the DHCP IP to set WAN, and modify LAN’s networks ID(for example, system will change LAN IP from 192.168.10.1 to 192.168.11.1) when system uses DHCP client to get IP in startup; if system uses DHCP client to get IP in running status and network ID is also same as LAN’s, system will refuse to accept the IP to configure WAN. So WAN’s active IP will be 0.0.0.0

4.3.2.2. LAN Config

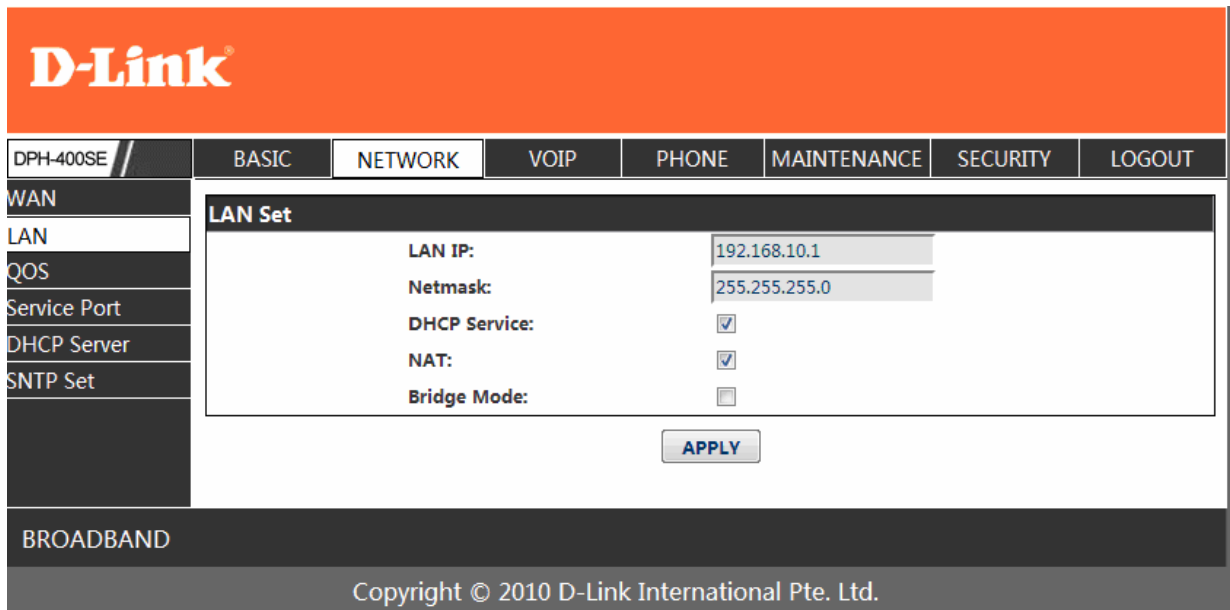

LAN Config

Field name	explanation
LAN IP	Specify LAN static IP.
Net mask	Specify LAN Net mask.
DHCP Service	Select the DHCP server of LAN port or not. After you modify the LAN IP address, phone will amend and adjust the DHCP Lease Table and save the result amended automatically according to the IP address and Net mask. You need restart the phone and the DHCP server setting will take effect.
NAT	Select NAT or not.
Bridge Mode	Select Bridge Mode or not: If you select Bridge Mode, the phone will no longer set IP address for LAN physical port, LAN and WAN will join in the same network. Click “Apply”, the phone will reboot.

Notice: If you choose the bridge mode, the LAN configuration will be disabled.

4.3.2.3. QoS Config

The VOIP phone support 802.1Q/P protocol and DiffServ configuration. VLAN functionality can use different VLAN IDs by setting signal/voice VLAN and data VLAN. The VLAN application of this phone is very flexible.

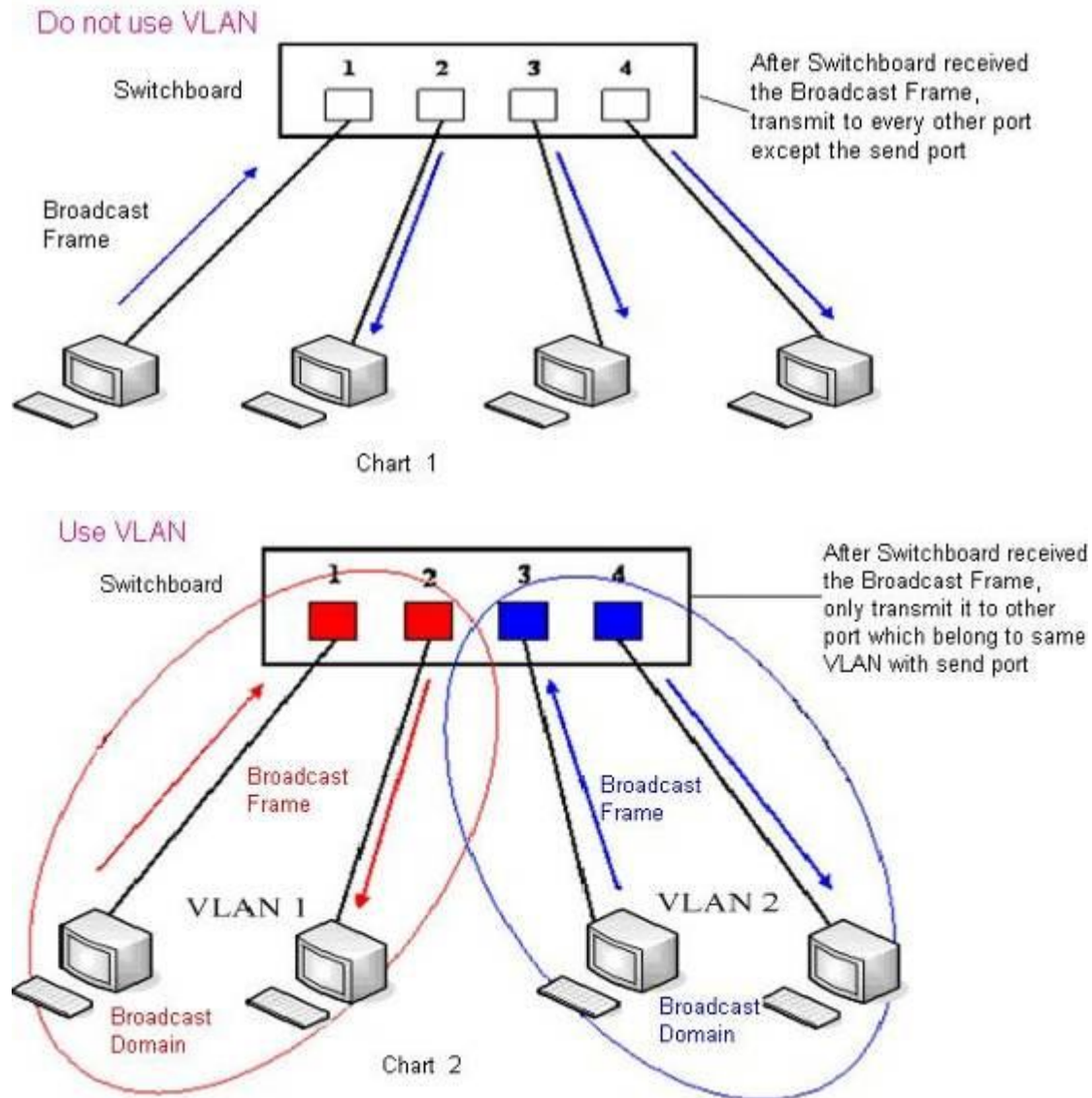

In chart 1, there is a layer 2 switch without setting VLAN. Any broadcast frame will be transmitted to the other ports except the send port. For example, a broadcast information is sent out from port 1 then transmitted to port 2,3and 4.

In chart 2, red and blue indicate two different VLANs in the switch, and port 1 and port 2 belong to red VLAN, port 3 and port 4 belong to blue VLAN. If a broadcast frame is sent out from port 1, switch will transmit it to port 2, the other port in the red VLAN and not transmit it to port3 and port 4 in blue VLAN. By this means, VLAN divide the broadcast domain via restricting the range of broadcast frame transmission.

Note: chart 2 use red and blue to identify the different VLAN, but in practice, VLAN uses different VLAN IDs to identify.

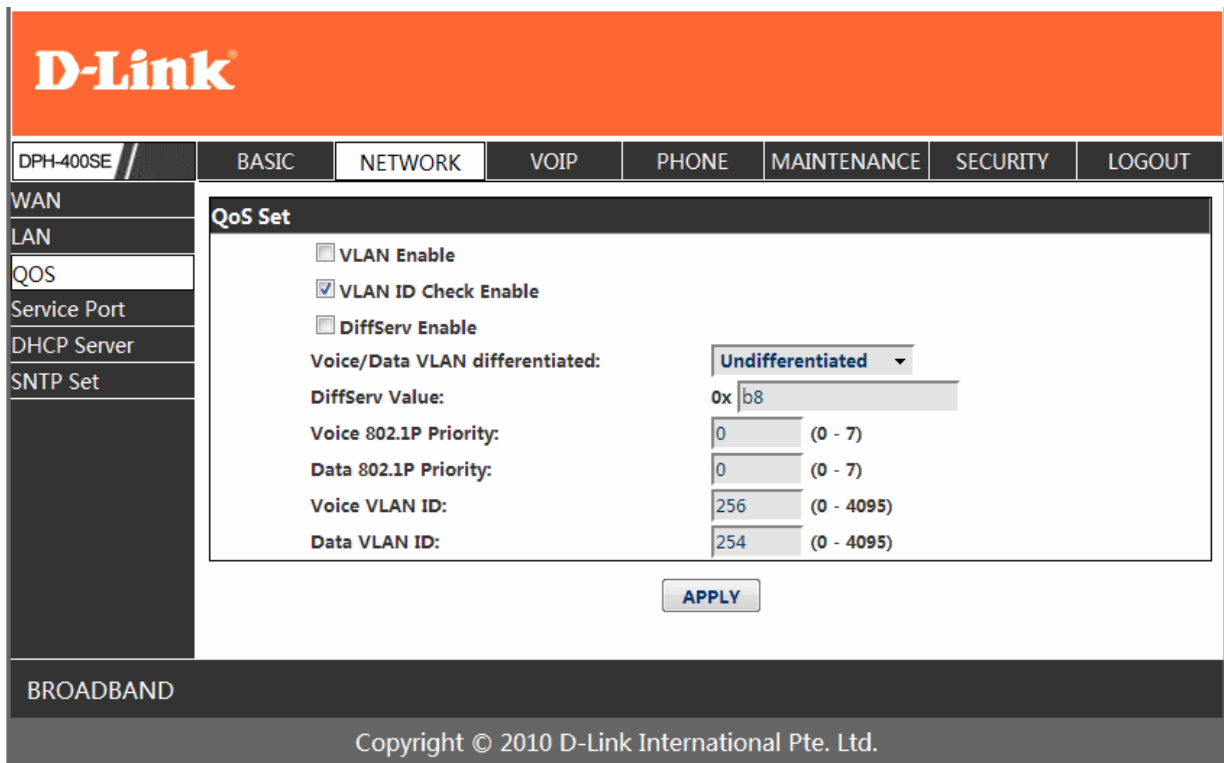

QoS Configuration

Field name	explanation
VLAN Enable	Before select it to enable VLAN, you need enable Bridge mode in LAN config.
VLAN ID Check Enable	Enable VLAN ID check by selecting it. After enable VLAN ID check, if VLAN ID of a data package is not the same with the phone's or a data package do not have VLAN ID, the data package will be discarded.
Voice/Data VLAN differentiated	After enable VLAN, system will set packets with different type of VLAN ID. Undifferentiated means after using VLAN, both VoIP packets and other data packets will use the voice VLAN ID; tag differentiated means after using VLAN, VoIP(signal and voice) packets will add voice VLAN ID, and other data packets will add data VLAN ID; data untagged means after using VLAN, only VoIP packets will add voice VLAN ID. Other data packets will not use VLAN.
DiffServ Enable	Select it or not to Enable or disable DiffServ.
DiffServ Value	Set DiffServ value, the common value is 0x00.
Voice 802.1P Priority	Specify 802.1P Priority of voice/signal data package.
Data 802.1P Priority	Set 802.1p of data VLAN. Non-VoIP data (such as http, telnet, ping etc) will use this value to set VLAN package.
Voice VLAN ID	Set VLAN ID of voice/signal data package.
Data VLAN ID	Set 802.1q of data VLAN ID. Non-VoIP data (such as http, telnet, ping etc) will use this value to set VLAN package.

NOTICE:

- 1) Startup VLAN, if set Voice/Data VLAN differentiated as Undifferentiated, all packets will use the Voice VLAN ID as the tag.
- 2) Startup VLAN, if set Voice/Data VLAN differentiated as tag differentiated and disables the DiffServ, then system will not distinguish the voice and data, all packets will use the Voice VLAN ID as the tag.
- 3) Startup VLAN, if set Voice/Data VLAN differentiated as tag differentiated and enables the

- DiffServ, then system will distinguish the voice and data and add the VLAN ID each other.
- 4) Startup VLAN, if set Voice/Data VLAN differentiated as data untagged, then the packet of the signal/voice will use the Voice VLAN ID as the tag, but the data packets will not take the VLAN tag.
 - 5) If Disable the VLAN, regardless to set the Voice/Data VLAN differentiated or not, all packets will not take the VLAN tag; If enable the DiffServ, all packets will only take the DiffServ value.
 - 6) One must to notice, enable the VLAN ID Check Enable that is default, If enable it, the phone will match the VLAN ID strictly. When others' VLAN ID not match with us, the packets will discard. Contrarily, the phone will accept the packets with the distinct VLAN ID.
 - 7) You must gain the IP with the Static mode when you set VLAN, otherwise can't gain the IP in the VLAN and also can not dial with point to point.

4.3.2.4. Service Port

You can set the port of telnet/HTTP/RTP by this page.

The screenshot shows the D-Link web interface for the 'Service Port' configuration page. The interface includes a navigation menu with options like WAN, LAN, QOS, Service Port, DHCP Server, and SNTP Set. The 'Service Port' section is active, displaying configuration fields for HTTP Port (80), Telnet Port (23), RTP Initial Port (10000), and RTP Port Quantity (200). An 'APPLY' button is located below the fields. A warning message states: 'If modify HTTP or Telnet port, you'd better set it more than 1024, then restart.'

SERVICE PORT

Field name	explanation
HTTP Port	set web browse port, the default is 80 port, if you want to enhance system safety, you'd better change it into non-80 standard port; Example: The IP address is 192.168.1.70. and the port value is 8090, the accessing address is http://192.168.1.70:8090
Telnet Port	Set Telnet Port, the default is 23. You can change the value into others. Example: The IP address is 192.168.1.70. the telnet port value is 8023, the accessing address is telnet 192.168.1.70 8023
RTP Initial Port	Set the RTP Initial Port. It is dynamic allocation.
RTP Port Quantity	Set the maximum quantity of RTP Port, the default is 200.

Notice:

- 1) You need save the configuration and reboot the phone after set this page.
- 2) If you modify the port of Telnet and HTTP, you would better set the value more than 1024 because the port value less than 1024 is system port reserved.
- 3) if you set 0 for the HTTP port, it will disable HTTP service.

4.3.2.5. DHCP SERVER

DHCP SERVER

Field name	explanation
DHCP Leased Table	IP-MAC mapping table. If the LAN port of the phone connects to a device, this table will show the IP and MAC address of this device.

DHCP Lease Table						
Name	Start IP	End IP	Lease Time	Netmask	Gateway	DNS
lan	192.168.10.1	192.168.10.30	1440	255.255.255.0	192.168.10.1	192.168.10.1

Shows the DHCP Lease Table, the unit of Lease time is Minute.

Lease Table Name	Specify the name of the lease table
Start IP	Set the start IP address of the lease table
End IP	Set the end IP address of the lease table, the network device connected to LAN port will get IP address between Start IP and End IP by DHCP.
Netmask	Set the Netmask of the lease table
Gateway	Set the Gateway of the lease table
Lease Time	Set the Lease Time of the lease table
DNS	Set the default DNS server IP of the lease table; Click the Add button to submit and add this lease table

DHCP Lease Table Delete	
Lease Table Name:	lan <input type="button" value="Delete"/>

Select name of lease table, click the **Delete** button will delete the selected lease table from

DHCP lease table.

DNS Relay

Select DNS Relay, the default is enabled. Click the Apply button to become effective.

Notice:

- 1) The size of lease table can not be larger than the quantity of C network IP address. We recommend you to use the default lease table and not modify it.
- 2) If you modifies the DHCP lease table, you need save the configuration and reboot.

4.3.2.6. SNTP

Setting time zone and SNTP (Simple Network Time Protocol) server according to your location, you can also manually adjust date and time in this web page.

The screenshot shows the D-Link configuration page for SNTP. It includes a navigation menu on the left with options like WAN, LAN, QOS, Service Port, DHCP Server, and SNTP Set. The main content area is divided into three sections: SNTP Time Set, Daylight Timeset, and Manual Timeset. Each section has various input fields and an 'APPLY' button.

SNTP

Field name	explanation
Server	Set SNTP Server IP address.
Time Zone	Select the Time zone according to your location.
Time Out	Set the time out, the default is 60 seconds.
12 Hours Systems	Switch the time mechanism between 12 hours and 24 hours. Default is 24 hours mode
SNTP	Select the SNTP, and click Apply to make the SNTP Times effective.
Enable Daylight	Enable daylight saving time

Time shift(minutes) Setup the variety length
Month Setup stat and end month
Week Setup start and end week
Day Setup start and end day
Hour Setup start and end hours
Minute Setup start and end minutes

Manual Timeset	
Year:	<input type="text"/>
Months:	<input type="text"/>
Day:	<input type="text"/>
Hour:	<input type="text"/>
Minute:	<input type="text"/>
<input type="button" value="APPLY"/>	

Notice: You need specify the above all items.

4.3.3. VOIP

4.3.3.1. SIP Config

Set your SIP server in the following interface.

SIP Line Select

SIP 1

Load

Basic Setting

Register Status:	Registered	Display Name:	
Server Name:		Proxy Server Address:	
Server Address:	192.168.1.2	Proxy Server Port:	
Server Port:	5060	Proxy Username:	
Account Name:	123	Proxy Password:	
Password:	●●●	Domain Realm:	
Phone Number:	123	Enable Register:	<input checked="" type="checkbox"/>

APPLY

Advanced Set

Advanced SIP Setting

Register Expire Time:	60 seconds	Forward Type:	Off
NAT Keep Alive Interval:	60 seconds	Forward Phone Number:	
User Agent:	Voip Phone 1.0	Server Type:	COMMON
Signal Key:		DTMF Mode:	DTMF_RFC2833
Media Key:		RFC Protocol Edition:	RFC3261
Local Port:	5060	Transport Protocol:	UDP
Ring Type:	Music 1	RFC Privacy Edition:	NONE
Hot Line Number:		Subscribe Expire Time:	300 seconds
Conference Number:		Enable Conference Number:	<input type="checkbox"/>
Transfer Expire Time:	0 seconds	MWI Number:	
Enable Subscribe:	<input type="checkbox"/>	Click To Talk:	<input type="checkbox"/>
Enable Keep Authentication:	<input type="checkbox"/>	Signal Encode:	<input type="checkbox"/>
NAT Keep Alive:	<input type="checkbox"/>	Rtp Encode:	<input type="checkbox"/>
Enable Via rport:	<input checked="" type="checkbox"/>	Enable Session Timer:	<input type="checkbox"/>
Enable PRACK:	<input type="checkbox"/>	Answer With Single Codec:	<input type="checkbox"/>
Long Contact:	<input type="checkbox"/>	Auto TCP:	<input type="checkbox"/>
Enable URI Convert:	<input checked="" type="checkbox"/>	Enable Strict Proxy:	<input type="checkbox"/>
Dial Without Register:	<input type="checkbox"/>	Enable GRUU:	<input type="checkbox"/>
Ban Anonymous Call:	<input type="checkbox"/>	Enable Displayname Quote:	<input type="checkbox"/>
Enable DNS SRV:	<input type="checkbox"/>		

APPLY

SIP Config

Field name	explanation
SIP Line Select	
<div style="border: 1px solid #ccc; padding: 2px; display: inline-block;">SIP 1 ▾</div>	<div style="border: 1px solid #ccc; padding: 2px 10px; display: inline-block; background-color: #eee;">Load</div>

Choose line to set info about SIP, there are 3 lines to choose. You can switch by **【Load】** button.

Register Status	Shows if the phone has been registered the SIP server or not; or so, show Unapplied;
Server Name	Set the server name.
Server Address	Input your SIP server address.
Server Port	Set your SIP server port.
Account Name	Input your SIP register account name.
Password	Input your SIP register password.
Phone Number	Input the phone number assigned by your VoIP service provider. Phone will not register if there is no phone number configured.
Display Name	Set the display name.
Proxy Server Address	Set proxy server IP address (Usually, Register SIP Server configuration is the same as Proxy SIP Server. But if your VoIP service provider give different configurations between Register SIP Server and Proxy SIP Server, you need make different settings.)
Proxy Server Port	Set your Proxy SIP server port.
Proxy Username	Input your Proxy SIP server account.
Proxy Password	Input your Proxy SIP server password.
Domain Realm	Set the sip domain if needed, otherwise this VoIP phone will use the Register server address as sip domain automatically. (Usually it is same with registered server and proxy server IP address).
Enable Register	Start to register or not by selecting it or not.
Register Expire Time	Set expire time of SIP server register, default is 60 seconds. If the register time of the server requested is longer or shorter than the expire time set, the phone will change automatically the time into the time recommended by the server, and register again.
NAT Keep Alive Interval	Set examining interval of the server, default is 60 seconds
User Agent	Set the user agent if have, the default is VoIP Phone 1.0
Signal Key	Set the key for signal encryption
Media Key	Set the key for RTP encryption
Local port	Set sip port of each line
Ring type	Set ring type of each line
Hot line Number	Set hot line number of each line
Conference Number	Configure conference number in server conference.
Transfer Expire Time	For the phone supports the transfer of certain special features server, set interval time between sending “bye” and hanging up after the phone transfers a call.
Enable subscribe	Enable the option ,the phone will receive the notify from the server.
Enable Keep Authentication	Enable/Disable Keep Authentication System will take the last authentication field which is passed the authentication by server to the request packet. It will decrease the server’s repeat authorization work, if it is enable.
NAT Keep Alive	Enable/Disable keeps NAT of SIP alive. If some server refuse to register with too short interval time, and has no packets sending to device in private network to keep NAT alive, user could set this function ON. It need set the keep alive interval time less than the NAT server’s.

Enable Via rport	Enable/Disable system to support RFC3581. Via rport is special way to realize SIP NAT.
Enable PRACK	Enable or disable SIP PRACK function, suggest use the default config.
Long Contact	Set more parameters in contact field; connection with SEM server
Enable URI Convert	Convert # to %23 when send the URI.
Dial Without Register	Set call out by proxy without registration;
Ban Anonymous Call	Set to ban Anonymous Call;
Enable DNS SRV	Support DNS looking up with _sip.udp mode
Forward Type	Select call forward mode, the default is Off <ul style="list-style-type: none"> ● Off: Close down calling forward ● Busy: If the phone is busy, incoming calls will be forwarded to the appointed phone. ● No answer: If there is no answer, incoming calls will be forwarded to the appointed phone. ● Always: Incoming calls will be forwarded to the appoint phone directly. The phone will Prompt the incoming while doing forward.
Forward Phone Number	Appoint your forward phone number.
Server Type	Select the special type of server which is encrypted, or has some unique requirements or call flows.
DTMF Mode	Select DTMF sending mode, there are three modes: <ul style="list-style-type: none"> ● DTMF_RELAY ● DTMF_RFC2833 ● DTMF_SIP_INFO Different VoIP Service providers may provide different modes.
RFC Protocol Edition	Select SIP protocol version to adapt for the SIP server which uses the same version as you select. For example, if the server is CISCO5300, you need to change to RFC2543, else phone may not cancel call normally. System uses RFC3261 as default.
Transport Protocol	Set transport protocols, TCP or UDP;
RFC Privacy Edition	Set Anonymous call out safely; Support RFC3323and RFC3325;
Subscribe Expire Time	Overtime of resending subscribe packet. Suggest using the default config.
Enable Conference number	Set to use sever conference.
MWI Number	Input the number of the server's voice-mail box
Click to Talk	Set click to Talk (need practical software support).
Signal Encode	Enable/Disable Signal Encrypt.
RTP Encode	Enable/Disable RTP Encrypt.
Enable Session Timer	Set Enable/Disable Session Timer, whether support RFC4028.It will refresh the SIP sessions.
Answer With Single Codec	Enable/Disable the function when call is incoming, phone replies SIP message with just one codec which phone supports.
Auto TCP	Set to use automatically TCP protocol to guarantee usability of transport as message is above 1300 byte
Enable Strict Proxy	Support the special SIP server-when phone receives the packets sent from server, phone will use the source IP address, not the address in via field.
Enable GRUU	Set to support GRUU
Enable Display name Quote	Set to make quotation mark to display name as the phone sends out signal, in order to be compatible with server.

4.3.3.2. Stun Config

In this web page, you can config SIP STUN.

STUN:

By STUN server, the phone in private network could know the type of NAT and the NAT mapping IP and port of SIP. The phone might register itself to SIP server with global IP and port to realize the device both calling and being called in private network.

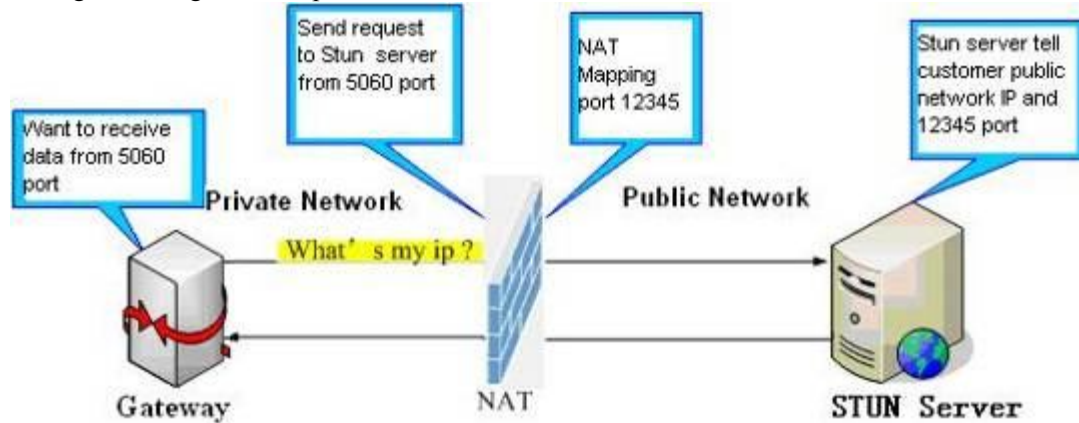

D-Link

DPH-400SE	BASIC	NETWORK	VOIP	PHONE	MAINTENANCE	SECURITY	LOGOUT
-----------	-------	---------	------	-------	-------------	----------	--------

SIP

Stun

Dial Peer

STUN Set

STUN NAT Transverse: FALSE

STUN Server Addr:

STUN Server Port:

STUN Effect Time: Seconds

Local SIP Port:

Set Sip Line Enable STUN

SIP 1

Set Sip Line Enable STUN

Use STUN

BROADBAND

Copyright © 2010 D-Link International Pte. Ltd.

STUN

Field name	explanation
STUN NAT Transverse	Shows STUN NAT Transverse estimation, true means STUN can penetrate NAT, while False means not.
STUN Server Addr	Set your SIP STUN Server IP address
STUN Server Port	Set your SIP STUN Server Port
STUN Effect Time	Set STUN Effective Time. If NAT server finds that a NAT mapping is idle after time out, it will release the mapping and the system need send a STUN packet to keep the mapping effective and alive.
Local SIP Port	Set the SIP port.

Set Sip Line Enable STUN	
SIP 1 ▾	Load

Choose line to set info about SIP, There are 3 lines to choose. You can switch by **【Load】** button.

Use Stun Enable/Disable SIP STUN.

Notice: SIP STUN is used to realize SIP penetration to NAT. If your phone configures STUN Server IP and Port (default is 3478), and enable SIP Stun, you can use the ordinary SIP Server to realize penetration to NAT.

4.3.3.3. DIAL PEER setting

This functionality offers you more flexible dial rule, you can refer to the following content to know how to use this dial rule. When you want to dial an IP address, the entry of IP addresses is very cumbersome, but by this functionality, you can set number 156 to replace 192.168.1.119 here.

Dial Peer Table						
Number	Destination	Port	Mode	Alias	Suffix	Del Length
156	192.168.1.119	5060	SIP	no alias	no suffix	0

When you want to dial a long distance call to Beijing, you need dial an area code 010 before local phone number, but you can also dial number 1 instead of 010 after we make a setting according to this dial rule. For example, you want to dial 01062213123, but you need dial only 162213123 to realize your long distance call after you make this setting.

Number	Destination	Port	Mode	Alias	Suffix	Del Length
1T	0.0.0.0	5060	SIP	rep:010	no suffix	1

To save the memory and avoid abundant input of user, add the follow functions:

Number	Destination	Port	Mode	Alias	Suffix	Del Length
13xxxxxxxx	0.0.0.0	5060	SIP	add:0	no suffix	0
13[5-9]xxxxxxxx	0.0.0.0	5060	SIP	add:0	no suffix	0

1、xMatch any single digit that is dialed.

If user makes the above configuration, after user dials 11 digit numbers started with 13, the phone will send out 0 plus the dialed numbers automatically.

2、[] Specifies a range that will match digit. It may be a range, a list of ranges separated by commas, or a list of digits.

If user makes the above configuration, after user dials 11 digit numbers started with from 135 to 139, the phone will send out 0 plus the dialed numbers automatically.

Use this phone you can realize dialing out via different lines without switch in web interface.

D-Link

DPH-400SE // BASIC NETWORK **VOIP** PHONE MAINTENANCE SECURITY LOGOUT

SIP
Stun
Dial Peer

Dial Peer Table

Number	Destination	Port	Mode	Alias	Suffix	Del Length
13xxxxxxxx	0.0.0.0	5060	SIP	add:0	no suffix	0
13[5-9]xxxxxxxx	0.0.0.0	5060	SIP	add:0	no suffix	0
156	192.168.1.119	5060	SIP	no alias	no suffix	0
1T	0.0.0.0	5060	SIP	rep:010	no suffix	1

Add Dial Peer

Phone Number:

Destination (optional):

Port(optional):

Alias(optional):

Call Mode: SIP ▼

Suffix(optional):

Delete Length (optional):

Dial Peer Option

13xxxxxxxx ▼

BROADBAND

Copyright © 2010 D-Link International Pte. Ltd.

DIAL PEER

Field name	explanation
Phone number	There are two types of matching conditions: one is full matching, the other is prefix matching. In the Full matching, you need input your desired phone number in this blank, and then you need dial the phone number to realize calling to what the phone number is mapped. In the prefix matching, you need input your desired prefix number and T; then dial the prefix and a phone number to realize calling to what your prefix number is mapped. The prefix number supports at most 30 digits
Destination	Set Destination address. This is optional config item. If you want to set peer to peer call, please input destination IP address or domain name. If you want to use this dial rule on SIP2 line, you need input 255.255.255.255 or 0.0.0.2 in it.SIP3 into 0.0.0.3
Port	Set the Signal port, the default is 5060 for SIP.
Alias	Set alias. This is optional config item. If you don't set Alias, it will show no alias.

Note: There are four types of aliases.

- 1) add: xxx, it means that you need dial xxx in front of phone number, which will reduce dialing number length.
 - 2) all: xxx, it means that xxx will replace some phone number.
 - 3) del: It means that phone will delete the number with length appointed.
 - 4) Rep: It means that phone will replace the number with length and number appointed.
- You can refer to the following examples of different alias application to know more how to use different aliases and this dial rule.

Call Mode	Select different signal protocol, SIP
Suffix	Set suffix, this is optional config item. It will show no suffix if you don't set it.
Delete Length	Set delete length. This is optional config item. For example: if the delete length is 3, the phone will delete the first 3 digits then send out the rest digits. You can refer to examples of different alias application to know how to set delete length.

Examples of different alias application

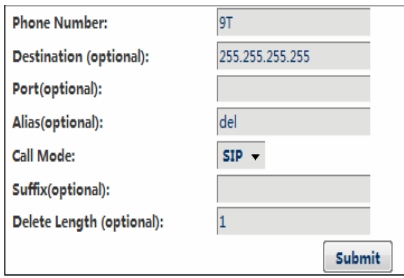
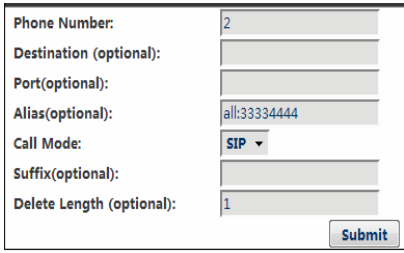
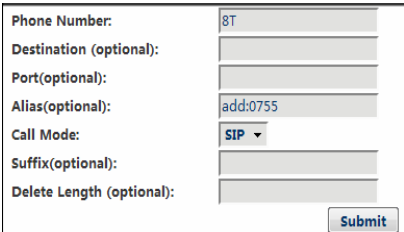
Set by web	explanation	example
 <p>Phone Number: 9T Destination (optional): 255.255.255.255 Port(optional): Alias(optional): del Call Mode: SIP Suffix(optional): Delete Length (optional): 1 Submit</p>	<p>You need set phone number, Destination, Alias and Delete Length. Phone number is XXXT; Destination is 255.255.255.255 (0.0.0.2) and Alias is del. This means any phone No. that starts with your set phone number will be sent via SIP2 line after the first several digits of your dialed phone number are deleted according to delete length.</p>	<p>If you dial “93333”, the SIP2 server will receive “3333”</p>
 <p>Phone Number: 2 Destination (optional): Port(optional): Alias(optional): all:33334444 Call Mode: SIP Suffix(optional): Delete Length (optional): 1 Submit</p>	<p>This setting will realize speed dial function, after you dialing the numeric key “2”, the number after all will be sent out.</p>	<p>When you dial “2”, the SIP1 server will receive 33334444</p>
 <p>Phone Number: 8T Destination (optional): Port(optional): Alias(optional): add:0755 Call Mode: SIP Suffix(optional): Delete Length (optional): Submit</p>	<p>The phone will automatically send out alias number adding your dialed number, if your dialed number starts with your set phone number.</p>	<p>When you dial “8309“, the SIP1 server will receive “07558309”</p>

<p>Phone Number: <input type="text" value="010T"/></p> <p>Destination (optional): <input type="text"/></p> <p>Port(optional): <input type="text"/></p> <p>Alias(optional): <input type="text" value="rep:0086"/></p> <p>Call Mode: <input type="text" value="SIP"/></p> <p>Suffix(optional): <input type="text"/></p> <p>Delete Length (optional): <input type="text" value="3"/></p> <p style="text-align: right;"><input type="button" value="Submit"/></p>	<p>You need set Phone Number, Alias and Delete Length. Phone number is XXXT and Alias is rep:xxx If your dialed phone number starts with your set phone number, the first digits same as your set phone number will be replaced by the alias number specified and New phone number will be send out.</p>	<p>When you dial “0106228”, the SIP1 server will receive “86106228”</p>
<p>Phone Number: <input type="text" value="147"/></p> <p>Destination (optional): <input type="text"/></p> <p>Port(optional): <input type="text"/></p> <p>Alias(optional): <input type="text"/></p> <p>Call Mode: <input type="text" value="SIP"/></p> <p>Suffix(optional): <input type="text" value="0011"/></p> <p>Delete Length (optional): <input type="text"/></p> <p style="text-align: right;"><input type="button" value="Submit"/></p>	<p>If your dialed phone number starts with your set phone number. The phone will send out your dialed phone number adding suffix number.</p>	<p>When you dial “147”, the SIP1 server will receive “1470011”</p>

4.3.4. Phone

4.3.4.1. DSP Config

In this page, you can configure voice codec, input/output volume and so on.

D-Link

DPH-400SE // BASIC NETWORK VOIP **PHONE** MAINTENANCE SECURITY LOGOUT

DSP

Call Service

Digital Map

Phone Book

Function Key

DSP Configuration

First Codec: Second Codec:

Third Codec: Fourth Codec:

Fifth Codec: Sixth Codec:

Handdown Time: ms Default Ring Type:

Input Volume: (1-9) Output Volume: (1-9)

Handfree Volume: (1-9) Ring Volume: (1-9)

G729 Payload Length: Signal Standard:

G723 Timestamps: G723 Bit Rate:

VAD: Dtmf Payload Type: (96-127)

BROADBAND

Copyright © 2010 D-Link International Pte. Ltd.

DSP Configuration

Field name	explanation
First Codec	The first preferential DSP codec: G.711A/u, G.722, G.723, G.729
Second Codec	The second preferential DSP codec: G.711A/u, G.723, G.729
Third Codec	The third preferential DSP codec: G.711A/u, G.723, G.729
Fourth Codec	The fourth preferential DSP codec: G.711A/u, G.723, G.729
Fifth Codec	The fifth preferential DSP codec: G.711A/u, G.723, G.729
Six Codec	The sixth preferential DSP codec: G.711A/u, G.723, G.729
Input Volume	Specify Input (MIC) Volume grade.;
Hands-free Volume	Specify Hands-free Volume grade
G729 Payload Length	Set G729 Payload Length
Handdown Time	Specify the least reflection time of Handdown, the default is 200ms.
Ring Type	Select Ring Type
Output Volume	Specify Output (receiver) Volume grade.
Ring Volume	Specify Ring Volume grade
G722 Timestamps	160/20ms or 320/20ms is available
G723 Bit Rate	5.3kb/s or 6.3kb/s is available
Default Ring Type	Set up the ring by default
Signal Standard	Select Signal Standard.
VAD	Select it or not to enable or disable VAD. If enable VAD, G729 Payload length could not be set over 20ms.

4.3.4.2. Call Service

In this web page, you can configure Hotline, Call Transfer, Call Waiting, 3 Ways Call, Black List, white list Limit List and so on.

D-Link

DPH-400SE // BASIC NETWORK VOIP **PHONE** MAINTENANCE SECURITY LOGOUT

DSP

Call Service

Digital Map

Phone Book

Function Key

Call Service Setting

Hot Line: No Answer Time: (seconds)

P2P IP Prefix:

Auto Answer:

Do Not Disturb: Ban Outgoing:

Enable Call Transfer: Enable Call Waiting:

Enable Three Way Call: Accept Any Call:

Enable Auto Handdown: XML Server:

APPLY

Black List

Black List

Limit List

Limit List

BROADBAND

Copyright © 2010 D-Link International Pte. Ltd.

Call Service

Field name	explanation
Hotline	Specify Hotline number. If you set the number, you can not dial any other numbers.
No Answer Time	Specify No Answer Time
P2P IP Prefix	Set Prefix in peer to peer IP call. For example: what you want to dial is 192.168.1.119, If you define P2P IP Prefix as 192.168.1., you dial only #119 to reach 192.168.1.119. Default is “.”. If there is no “.” Set, it means to disable dialing IP.
Remote Record No	Set Remote Record number. Via dialing this number, you can hear all voice records in your VoIP server.
Do Not Disturb	Select NO Disturb, the phone will reject any incoming call, the callers will be reminded by busy, but any outgoing call from the phone will work well.
Ban Outgoing Enable Call Transfer	If you select Ban Outgoing to enable it, and you can not dial out any number. Enable Call Transfer by selecting it.
Enable Call Waiting	Enable Call Waiting by selecting it.
Enable Three Way Call	Enable Three Way Call
Accept Any Call	If select it, the phone will accept the call even if the called number is not belong to the phone.
Auto Answer Use Record Server	If select it, the phone will auto answer when there is an incoming call. Select it or not to Enable or disable Use Record Server.
Auto handdown	The phone will hang up and return to standby automatically at hands-free mode
Black List	<p>Set Add/Delete Black list. If user does not want to answer some phone calls, add these phone numbers to the Black List, and these calls will be rejected. x and . are wildcard. x means matching any single digit. for example, 4xxx expresses any number with prefix 4 which length is 4 will be forbidden to dialed out</p> <p>DOT (.) means matching any arbitrary number digit. for example, 6. expresses any number with prefix 6 will be forbidden to dialed out.</p> <p>if user wants to allow a number or a series of number incoming, he may add the number(s) to the list as the white list rule. the configuration rule is -number, for example, -123456, or -1234xx</p> <div style="border: 1px solid black; padding: 5px; margin: 10px 0;"> <p style="text-align: center;">Black List</p> <p style="text-align: center;">-4119</p> </div> <p>Means any incoming number is forbidden except for 4119 Note: End with DOT (.) when set up the white list</p>
Limit List	<p>Set Add/Delete Limit List. Please input the prefix of those phone numbers which you forbid the phone to dial out. For example, if you want to forbid those phones of 001 as prefix to be dialed out, you need input 001 in the blank of limit list, and then you can not dial out any phone number whose prefix is 001.</p> <p>x and . are wildcard. x means matching any single digit. for example, 4xxx expresses any number with prefix 4 which length is 4 will be forbidden to dialed in</p> <p>. means matching any arbitrary number digit. for example, 6. expresses any number with prefix 6 will be forbidden to dialed in.</p>

Notice: Black List and Limit List can record at most 10 items respectively.

4.3.4.3. Digital Map Configuration

This system supports 4 dial modes:

- 1). End with “#”: dial your desired number, and then press #.
- 2). Fixed Length: the phone will intersect the number according to your specified length.
- 3). Time Out: After you stop dialing and waiting time out, system will send the number collected.
- 4). User defined: you can customize digital map rules to make dialing more flexible. It is realized by defining the prefix of phone number and number length of dialing.

In order to keep some users' secondary dialing manner when dialing the external line with PBX, phone can be added a special rule to realize it. so user can dial a number as external line prefix and get the secondary dial tone to keep dial the external number. After finishing dialing, phone will send the prefix and external number totally to the server.

For example, there is a rule 9, xxxxxxxx in the digital map table. After dialing 9, phone will send the secondary dial tone, user may keep going dialing. After finished, phone will call the number which starts with 9; actually the number sent out is 9-digit with 9.

Digital Map Configuration

Field name	explanation
End with "#"	Set Enable/Disable the phone ended with “#” dial.
Fixed Length	Specify the Fixed Length of phone ending with.
Time out	Set the timeout of the last dial digit. The call will be sent after timeout.

Below is user-defined digital map rule:

[] Specifies a range that will match digit. May be a range, a list of ranges separated by commas, or a list of digits.

x Match any single digit that is dialed.

. Match any arbitrary number of digits including none.

Tn Indicates an additional time out period before digits are sent of n seconds in length. n is mandatory and can have a value of 0 to 9 seconds. Tn must be the last 2 characters of a dial plan. If Tn is not specified it is assumed to be T0 by default on all dial plans.

```

Rules:
"[1-8]xxxx"
"9xxxxxxx"
"911"
"99T4"
"9911x.T4"

```

- Cause extensions 1000-8999 to be dialed immediately
- Cause 8 digit numbers started with 9 to be dialed immediately
- Cause 911 to be dialed immediately after it is entered.
- Cause 99 to be dialed after 4 seconds.
- Cause any number started with 9911 to be dialed 4 seconds after dialing ceases.

Notice: End with “#”, Fixed Length, Time out and Digital Map Table can be used simultaneously, System will stop dialing and send number according to your set rules.

4.3.4.4. Phone Book

You can input the name, phone number and select ring type for each name here.

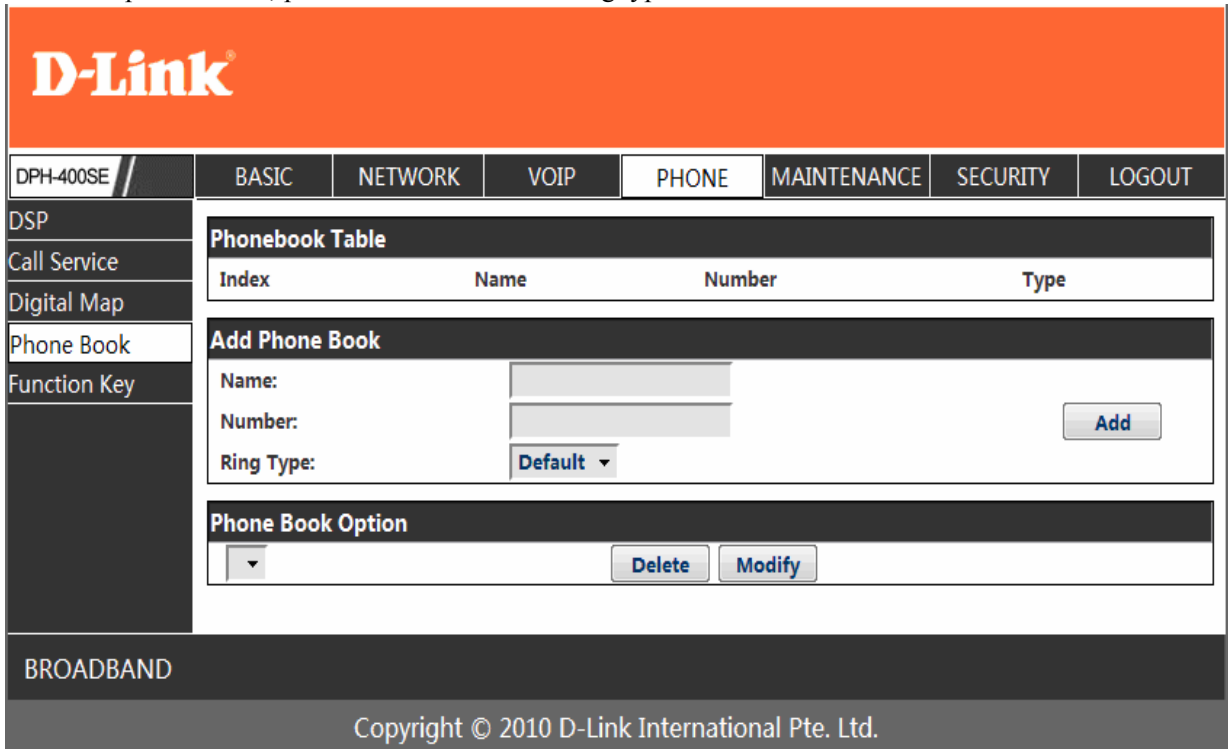

Phone Book

Field name		explanation	
Index	Name	Number	Type
1	ad	23	Default

Shows the detail of current phonebook.

- Name Shows the name corresponding to the phone number
 - Number Shows the phone number
 - Ring Type Shows the ring type of the incoming call.
- Click “Modify” to change the selected information and click the “Delete” to delete the selected record.

Notice: the maximum capability of the phonebook is 500 items

4.3.4.5. Function Key

D-Link

DPH-400SE // BASIC NETWORK VOIP **PHONE** MAINTENANCE SECURITY LOGOUT

DSP
Call Service
Digital Map
Phone Book
Function Key

Interface Configuration

Contrast: 5 (1-9) Luminance: 1 (0-1)
MWI Number:

APPLY

Function Key Setting

F 1	Line	SIP1:Line1
F 2	Line	SIP2:Line2
F 3	Line	SIP3:Line3
F 4	Memory Key	
F 5	Memory Key	
F 6	Memory Key	
F 7	Memory Key	
F 8	Memory Key	
F 9	Memory Key	
F 10	Key Event	F_MWI

APPLY

BROADBAND

Copyright © 2010 D-Link International Pte. Ltd.

Function Key

Field name	explanation
Contrast	Set contrast of screen
Luminance	Set luminance of screen
MWI Number	To listening record in server , we defined the function key F10 ,After you set it, you can pick up or hands-free, then press  to listen record in server.

Function Key Setting

F 1	Line	SIP1:Line1
F 2	Line	SIP2:Line2
F 3	Line	SIP3:Line3
F 4	Memory Key	
F 5	Memory Key	
F 6	Memory Key	
F 7	Memory Key	
F 8	Memory Key	
F 9	Memory Key	
F 10	Key Event	F_MWI

Line: select SIP1, SIP2, SIP3, Dial peer, in function key type. After you set it, you pick up handset or hands-free, press this function key, then you can use the corresponding IP line.

Memory Key: you can set a number for each memory key. After set it, you can dial the number you set by pressing this memory key.

Key event: function mode

Remark:

- You can set speed dial function by Memory Key mode.

For example, you need set speed dial 8000 via sip 1.

Select memory key in F4's function key type, then fill 8000@1/f in the corresponding right table.

- You can set shortcut key of pbook, redial, DND, MWI, call forward, or callers by Key Event mode in function key type.

Select key event in function key type, then fill F_PBOOK, F_REDIAL, F_DND, F_MWI, F_CFWD, or F_CALLERS in the corresponding right table.

For example:

F 10	Key Event	F_BOOK
------	-----------	--------

4.3.5. Maintenance

4.3.5.1. Auto Provision

The screenshot shows the D-Link web interface for a DPH-400SE device. The 'MAINTENANCE' tab is selected, and the 'Auto Update Setting' page is displayed. The interface includes a sidebar with navigation options: Autoprovision, SYSLOG, Config, Update, Account Set, and Reboot. The main content area contains the following settings:

- Current Config Version: 2.0002
- Server Address: 0.0.0.0
- Username: user
- Password: masked with four dots
- Config File Name: (empty field)
- Config Encrypt Key: (empty field)
- Protocol Type: FTP
- Update Interval Time: 1 Hour
- Update Mode: Disable
- Enable DHCP Option 66:

An 'APPLY' button is located at the bottom of the settings area. The footer of the page reads 'Copyright © 2010 D-Link International Pte. Ltd.' and 'BROADBAND' is visible in the bottom left corner.

Auto Provision

Field name	explanation
Current Config Version	Show the current config file's version.
Server Address	Set FTP/TFTP/HTTP server IP address for auto update. The address can be IP address or Domain name with subdirectory.
Username	Set FTP server Username. System will use anonymous if username keep blank.
Password	Set FTP server Password.
Config File Name	Set configuration file's name which need to update. System will use MAC as config file name if config file name keep blank. For

Config Encrypt Key	example, 000102030405.。
Protocol Type	Select the Protocol type FTP、 TFTP or HTTP.
Update Interval Time	Set update interval time, unit is hour. Different update modes:
Update Mode	1. Disable: means no update 2. Update after reboot: means update after reboot. 3. Update at time interval: means periodic update.

4.3.5.2. Syslog Config

Syslog is a protocol which is used to record the log messages with client/server mechanism. Syslog server receives the messages from clients, and classifies them based on priority and type. Then these messages will be written into log by some rules which administrator can configure. This is a better way for log management.

8 levels in debug information:

Level 0---emergency: This is highest default debug info level. You system can not work.

Level 1---alert: Your system has deadly problem.

Level 2---critical: Your system has serious problem.

Level 3---error: The error will affect your system working.

Level 4---warning: There are some potential dangers. But your system can work.

Level 5---notice: Your system works well in special condition, but you need to check its working environment and parameter.

Level 6---info: the daily debugging info.

Level 7---debug: the lowest debug info. Professional debugging info from R&D person.

At present, the lowest level of debug information send to Syslog is info, debug level only can be displayed on telnet.

Syslog Configuration

Field name	explanation
Server IP	Set Syslog server IP address.
Server Port	Set Syslog server port.
MGR Log Level	Set the level of MGR log.
SIP Log Level	Set the level of SIP log.
Enable Syslog	Select it or not to enable or disable syslog.

4.3.5.3. Config Setting

Config Setting

Field name	explanation
Save Config	you can save all changes of configurations. Click the Save button, all changes of configuration will be saved, and be effective immediately. .
Backup Config	Right clicks on “Right click here...” and select “Save Target As...” then you will save the config file in .txt format user can restore factory default configuration and reboot the phone.
Clear Config	If you login as Admin, the phone will reset all configurations and restore factory default; if you login as Guest, the phone will reset all configurations except for VoIP accounts (SIP1-3) and version number.

4.3.5.4. Update

You can update your configuration with your config file in this web page.

The screenshot shows the D-Link web interface for a DPH-400SE device. The 'MAINTENANCE' tab is selected. Under the 'Update' menu item, there are two sections: 'Web Update' and 'FTP Update'. The 'Web Update' section has a 'Select file' button with a browse icon and a file type filter of (*.*.txt,*.au,*.wav), followed by an 'Update' button. The 'FTP Update' section contains several input fields: 'Server', 'Username', 'Password', and 'File Name'. It also has two dropdown menus: 'Type' set to 'Application update' and 'Protocol' set to 'FTP'. An 'APPLY' button is located at the bottom of the FTP Update section.

Update

Field name	explanation
Web Update	Click the browse button, find out the config file saved before or provided by manufacturer, download it to the phone directly, press "Update" to save. You can also update downloaded update file, logo picture, ring, mmiset file by web.
Server	Set the FTP/TFTP server address for download/upload. The address can be IP address or Domain name with subdirectory.
Username	Set the FTP server Username for download/upload.
Password	Set the FTP server password for download/upload.
File name	Set the name of update file or config file. The default name is the MAC of the phone, such as 000102030405.

Notice: You can modify the exported config file. And you can also download config file which includes several modules that need to be imported. For example, you can download a config file just keep with SIP module. After reboot, other modules of system still use previous setting and are not lost.

Type	Action type that system want to execute: 1. Application update: download system update file 2. Config file export: Upload the config file to FTP/TFTP server, name and save it. 3. Config file import: Download the config file to phone from FTP/TFTP server. The configuration will be effective after the phone is reset.
Protocol	Select FTP/TFTP server

4.3.5.5. Account Config

You can add or delete user account, and change the authority of each user account in this web page

The screenshot displays the D-Link web interface for account configuration. The top navigation bar includes 'BASIC', 'NETWORK', 'VOIP', 'PHONE', 'MAINTENANCE', 'SECURITY', and 'LOGOUT'. The left sidebar lists various system functions like 'Autoprovision', 'SYSLOG', 'Config', 'Update', 'Account Set', and 'Reboot'. The main content area is divided into several sections:

- Set Keyboard Password:** A form with a 'Keyboard Password' input field and a 'Set' button.
- User Set:** A table showing existing users:

User Name	User Level
admin	Root
guest	General
- Add User:** A form with fields for 'User Name', 'User Level' (a dropdown menu currently set to 'Root'), 'Password', and 'Confirm', along with a 'Submit' button.
- Account Option:** A section with a dropdown menu showing 'admin' and buttons for 'Delete' and 'Modify'.

The footer of the interface includes the text 'BROADBAND' and 'Copyright © 2010 D-Link International Pte. Ltd.'

Account Configuration

Field name	explanation						
Keyboard Password	Set the password for entering the setting menu of the phone by the phone 's key board. The password is digit.						
	<table border="1"> <thead> <tr> <th>User Name</th> <th>User Level</th> </tr> </thead> <tbody> <tr> <td>admin</td> <td>Root</td> </tr> <tr> <td>guest</td> <td>General</td> </tr> </tbody> </table>	User Name	User Level	admin	Root	guest	General
User Name	User Level						
admin	Root						
guest	General						

This table shows the current user existed.

User Name	Set account user name.
User Level	Set user level, Root user has the right to modify configuration, General can only read.
Password	Set the password.
Confirm	Confirm the password.

Select the account and click the **Modify** to modify the selected account, and click the **Delete** to delete the selected account.

General user only can add the user whose level is General.

4.3.5.6. Reboot



If you modified some configurations which need the phone's reboot to be effective, you need click the Reboot, then the phone will reboot immediately.

Notice: Before reboot, you need confirm that you have saved all configurations..

4.3.6. Security

4.3.6.1. MMI Filter

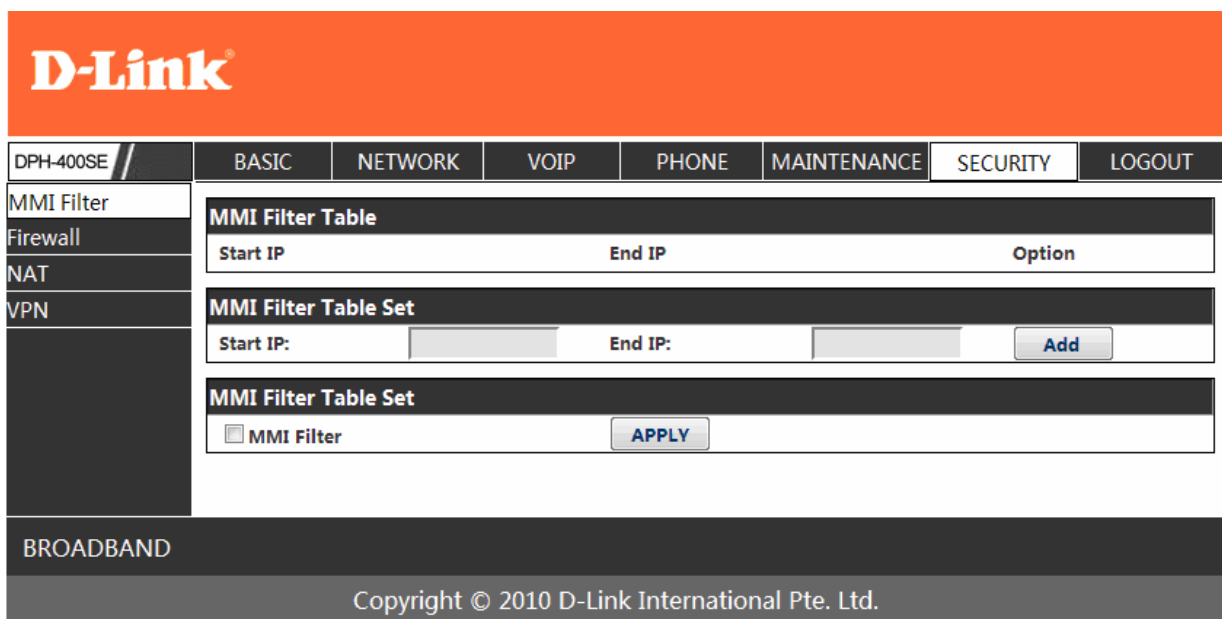

MMI Filter

User could make some device own IP, which is pre-specified, access to the MMI of the phone to config and manage the phone.

Field name	explanation	
Start IP	End IP	Option
192.168.1.15	192.168.1.20	Modify Delete

MMI Filter IP Table list:

MMI Filter Table Set			
Start IP:	<input type="text"/>	End IP:	<input type="text"/>
			<input type="button" value="Add"/>

Add or delete the IP address segments that access to the phone.
Set initial IP address in the Start IP column, Set end IP address in the End IP column, and click Add to add this IP segment. You can also click Delete to delete the selected IP segment.

MMI Filter Select it or not to enable or disable MMI Filter. Click **Apply** to make it effective.

Notice: Do not set your visiting IP outside the MMI filter range, otherwise, you can not logon through the web.

4.3.6.2. Firewall

Firewall Configuration

In this web interface, you can set up firewall to prevent unauthorized Internet users from accessing private networks connected to the Internet (input rule), or prevent unauthorized private network devices from accessing the Internet (output rule).

Firewall supports two types of rules: input access rule and output access rule. Each type supports at most 10 items.

Through this web page, you could set up and enable/disable firewall with input/output rules. System could prevent unauthorized access, or access other networks set in rules for security. Firewall, is also called access list, is a simple implementation of a Cisco-like access list (firewall). It supports two access lists: one for filtering input packets, and the other for filtering output packets. Each kind of list could be added 10 items.

We will give you an instance for your reference.

Firewall Type					
<input type="checkbox"/> In_access Enable			<input type="checkbox"/> Out_access Enable		
Input/Output:	<input type="text" value="Input"/>	Src Addr:	<input type="text"/>		
Deny/Permit:	<input type="text" value="Deny"/>	Des Addr:	<input type="text"/>	<input type="button" value="Add"/>	
Protocol Type:	<input type="text" value="UDP"/>	Src Mask:	<input type="text"/>		
Port Range:	<input type="text" value="more than"/>	Des Mask:	<input type="text"/>		

Field name	explanation
In access enable	Select it to Enable in_ access rule
out access enable	Select it to Enable out_ access rule
Input/Output	Specify current adding rule by selecting input rule or output rule.
Deny/Permit	Specify current adding rule by selecting Deny rule or Permit rule.
Protocol Type	Filter protocol type. You can select TCP, UDP, ICMP, or IP.
Port Range	Set the filter Port range
Src Addr	Set source address. It can be single IP address, network address, complete address 0.0.0.0, or network address similar to *.*.*.0
Des Addr	Set the destination address. It can be IP address, network address, complete address 0.0.0.0, or network address similar to *.*.*.*
Src Mask	Set the source address' mask. For example, 255.255.255.255 means just point to one host; 255.255.255.0 means point to a network which network ID is C type.
Des Mask	Set the destination address' mask. For example, 255.255.255.255 means just point to one host; 255.255.255.0 means point to a network which network ID is C type.

Click the **Add** button if you want to add a new output rule.

Firewall Output Rule Table								
Index	Deny/Permit	Protocol	Src Addr	Src Mask	Des Addr	Des Mask	Range	Port
1	Deny	ICMP	192.168.1.14	255.255.255.0	192.168.1.118	255.255.255.0	More than	0

Then enable out access, and click the Apply button.

So when devices execute to ping 192.168.1.118, system will deny the request to send icmp request to 192.168.1.118 for the out access rule. But if devices ping other devices which network ID is 192.168.1.0, it will be normal.

Rule Delete			
Input/Output:	<input type="text" value="Input"/>	Index To Be Deleted:	<input type="text"/>
			<input type="button" value="Delete"/>

Click the **Delete** button to delete the selected rule.

4.3.6.3. NAT Config

NAT is abbreviated from Net Address Translation; it's a protocol responsible for IP address translation. In other word, it is responsible for transforming IP and port of private network to public, also is the IP address mapping which we usually say.

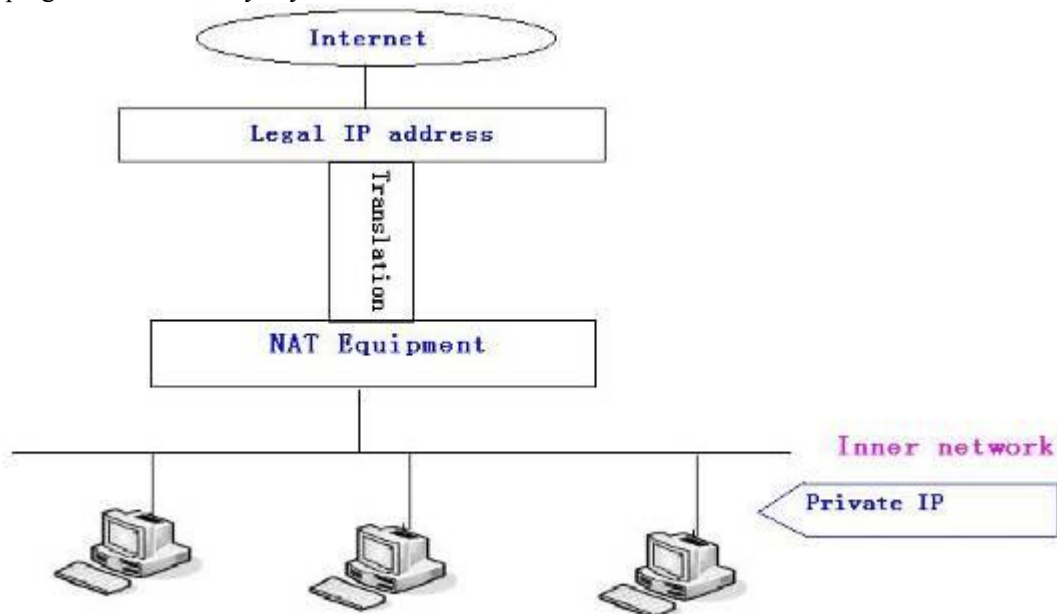

DMZ config:

In order to make some intranet equipments support better service for extranet, and make internal network security more effectively, these equipments open to extranet need be separated from the other equipments not open to extranet by the corresponding isolation method according to different demands. We can provide the different security level protection in terms of the different resources by building a DMZ region which can provide the network level protection for the equipments environment, reduce the risk which is caused by providing service to distrust customer, and is the best position to put public information

The following chart describes the network access control of DMZ

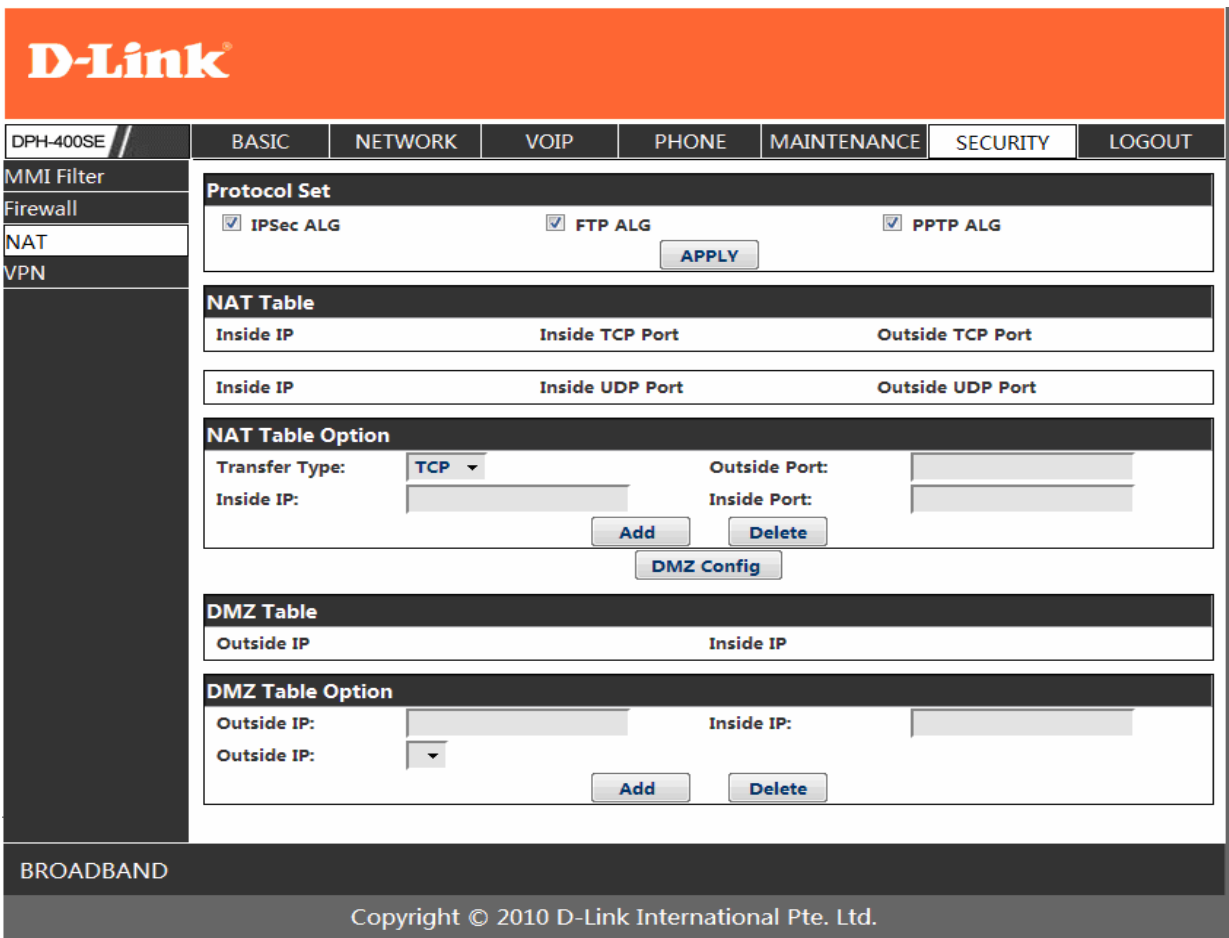

NAT Configuration

Field name	explanation
IPSec ALG	It is an encryption technology. Select it to enable IPSec ALG, the default is enable
FTP ALG	FTP is a service of connection layer which can transform intranet IP into extranet IP when intranet IP is sending out packet.
PPTP ALG	Select it to enable FTP ALG, the default is enable Select it enable PPTP ALG, the default is enable

Inside IP	Inside TCP Port	Outside TCP Port
Shows the NAT TCP mapping table		

Inside IP	Inside UDP Port	Outside UDP Port
Shows the NAT UDP mapping table		

NAT Table Option			
Transfer Type:	<input type="text" value="TCP"/>	Outside Port:	<input type="text"/>
Inside IP:	<input type="text"/>	Inside Port:	<input type="text"/>
<input type="button" value="Add"/>		<input type="button" value="Delete"/>	

Transfer Type	Select the NAT mapping protocol style, TCP or UDP
Inside IP	Set the IP address of device which is connected to LAN interface to do NAT mapping.
Inside Port	Set the LAN port of the NAT mapping
Outside Port	Set the WAN port of the NAT mapping

Notice: After finish setting, click the Add button to add new mapping table; click the Delete button to delete the selected mapping table.

DMZ Table	
Outside IP	Inside IP
192.168.1.119	192.168.10.23

Shows the outside WAN port IP address and the inside LAN port IP address.

Outside IP:	<input type="text"/>
Inside IP:	<input type="text"/>
Outside IP:	<input type="text" value="192.168.1.119"/>
<input type="button" value="Add"/> <input type="button" value="Delete"/>	

Outside IP Set the outside Wan port IP address of DMZ.

Inside IP Set the inside LAN port IP address of DMZ

Click the **Add** button to add new table; click the **Delete** button to delete the selected mapping table.

Notice: 10M/100M adaptive means the network card, and other equipment physical consultations speed, testing speed under bridge mode near to 100M, in order to ensure the quality of voice and communications real-time performance, we made some sacrifices of NAT under the transmission performance. Transmit with full capability only when system is idle, so can not guarantee that the transmission speed reach to 100M.

4.3.6.4. VPN Config

This web page provides us a safe connect mode by which we can make remote access to enterprise inner network from public network. That is to say, you can set it to connect public networks in different areas into inner network via a special tunnel.

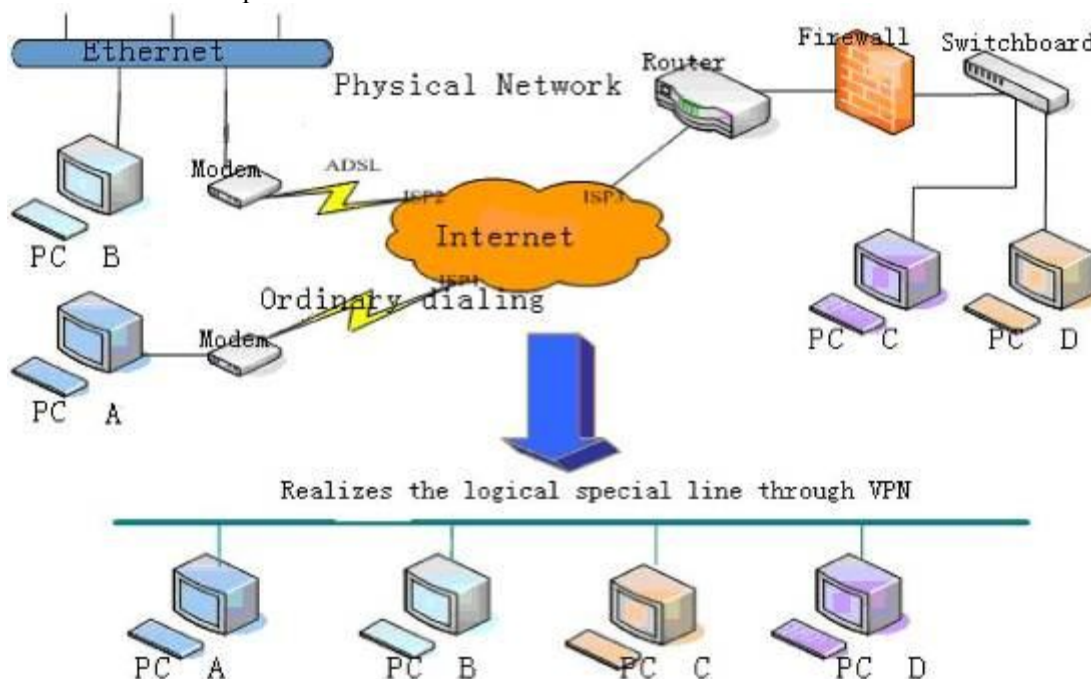

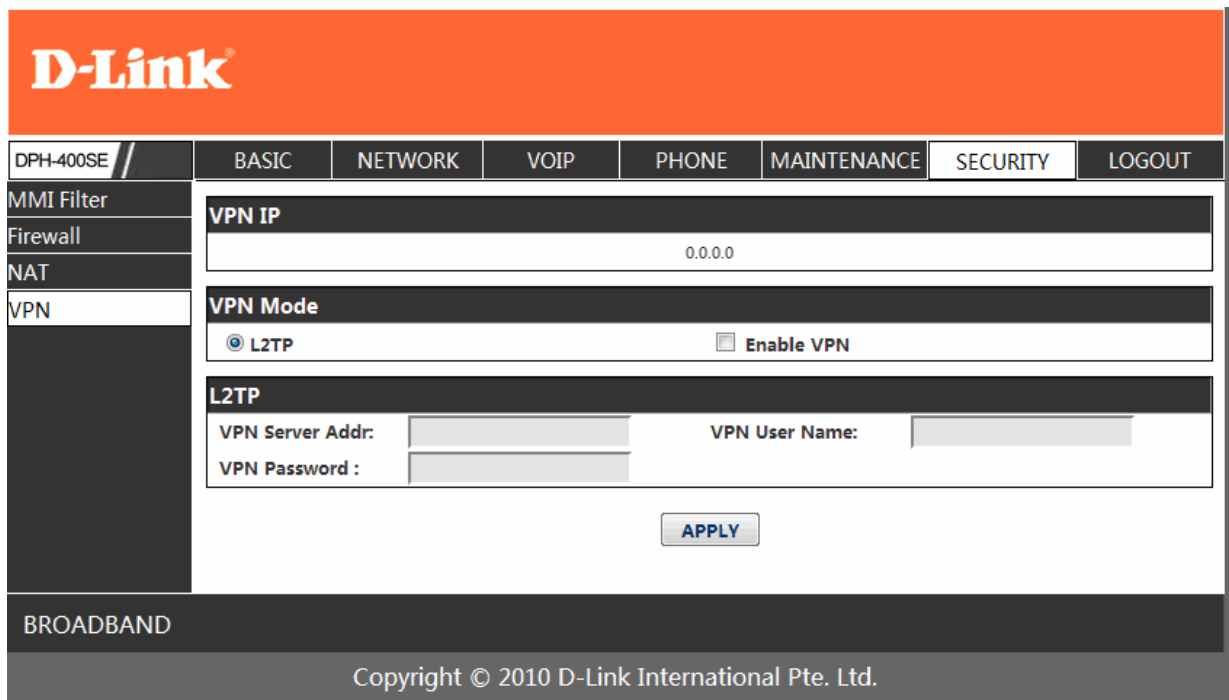

VPN Configuration

Field name	explanation
VPN IP	Shows the current VPN IP address
Enable VPN	Select it or not to enable or disable VPN;
L2TP	
VPN Server Addr:	VPN User Name:
VPN Password :	

- VPN Server Addr Set VPN L2TP Server IP address
- VPN User Name Set User Name access to VPN L2TP Server
- VPN Password Set Password access to VPN L2TP Server



4.3.7. Logout



Click **Logout**, and you will exit web page. If you want to enter it next time, you need input user name and password again.

5. Configuration via Keypad

5.1. Keypad introduction

User can browse, modify or cancel via screen menu by using  and 

❖ Use need input password (default 123),when login the menu (system config)

5.2. Menu Tree

Menu Tree List:

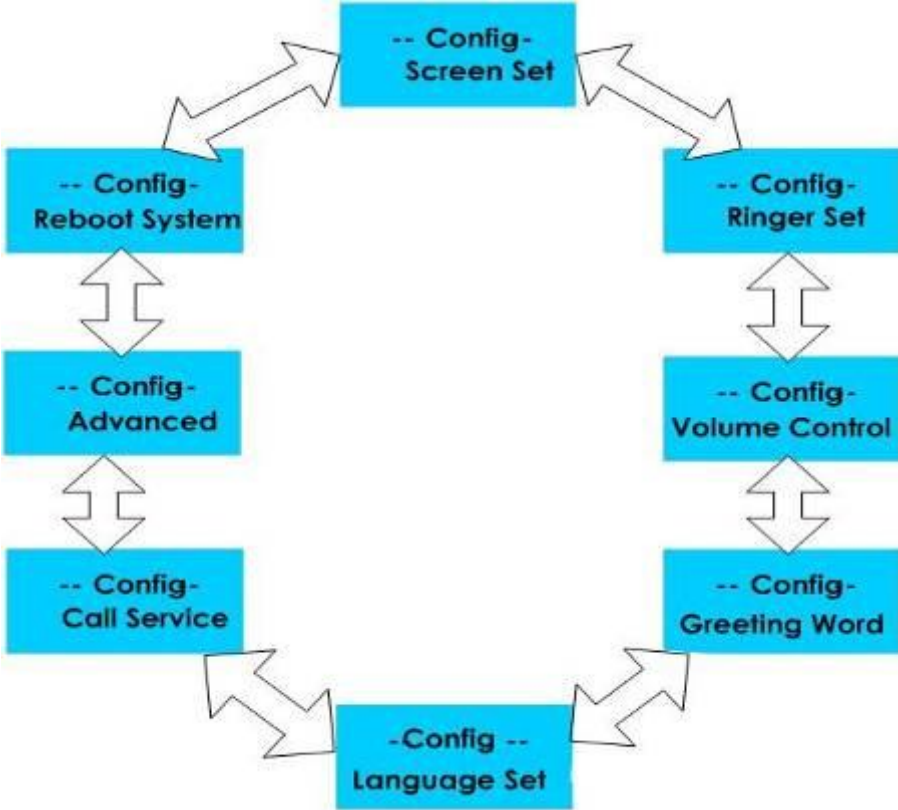

6. Appendix

6.1. Specification

6.1.1. Hardware

Item	DPH-400SE
Adapter (Input/Output)	Input: 100-240V Output: 5V 1A
port	WAN 10/100Base- T RJ-45 for LAN
	LAN 10/100Base- T RJ-45 for PC
Power Consumption	Idle: 2.5W/Active: 2.8W
LCD Size	128*64 dot matrix LCD
Operation Temperature	0~40°C
Relative Humidity	10~65%
CPU	Broadcom
SDRAM	128M
Flash	32M
Dimension(L x W x H)	11.6×8×3 in.(295×205×75mm)
Weight	0.955kg

6.1.2. Voice features

- SIP supports 3 SIP servers
- Support SIP 2.0 (RFC3261) and correlative RFCs
- Codec: G.711A/u, G.723.1 high/low, G.729a/b, G.722, G.722.1, G.726
- Echo cancellation: G.168 Compliance in LEC, additional acoustic echo cancellation(AEC) can reach 96ms max filter length in hands-free mode
- Support Voice Gain Setting, VAD, CNG
- Support full duplex hands-free
- SIP support SIP domain, SIP authentication(none basic, MD5), DNS name of server, Peer to Peer/ IP call
- Automatically select calling line, if one line can't be connected, the phone can automatically switch to other line to call.
- DTMF Relay: support SIP info, DTMF Relay, RFC2833
- SIP application: SIP Call forward/transfer (blind/attended) /hold/waiting/3 way talking/
- Exchange /sms /pickup /joincall /redial /unredial /vport
- Call control features: Flexible dial map, hotline, empty calling No. reject service, black list for reject authenticated call, limit call, no disturb, caller ID, Flexible deer peer rule.
- Support phonebook 500 records, Incoming calls / outgoing calls / missing calls. Each supports 100 records
- Support conference on server.
- Phonebook supports vcard standard
- 12/24 hours time display
- Support daylight saving time
- Support path
- Support SIP Privacy
- Support SMS
- Support Memo
- Support WMI
- Support Speed dial
- Support Alarm clock

6.1.3. Network features

- WAN/LAN: support bridge and router model
- Support PPPoE for xDSL
- Support basic NAT and NATP
- Support VLAN (optional: voice vlan/ data vlan)
- NAT Penetrate, Stun Penetrate
- Support DMZ
- Support VPN (L2TP) function
- Wan Port supports main DNS and secondary DNS server, can select dynamically to get DNS in DHCP mode or statically set DNS address.
- Support DHCP client on WAN
- Support DHCP server on LAN
- QoS with DiffServ
- Network tools in telnet server: including ping, trace route, telnet client







6.1.4. Maintenance and management

- Upgrade firmware through POST mode
- Web ,telnet and keypad management
- Management with different account right
- LCD and WEB configuration can be modified into requested language, and support multi-language dynamically shifted
- Upgrade firmware through HTTP, FTP or TFTP Telnet remote management/ upload/download setting file
- Support Syslog
- Support Auto Provisioning (upgrade firmware or configuration file)

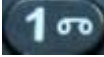
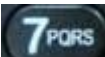
6.1.5. Special features

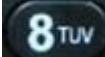
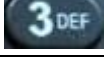
- Support 3 softkeys, 6 memory keys, Navigation key.
- RLS,Pbook,MWI,HOLD,Trans,Mute,L1-L3,Vol -/+,Redial

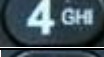
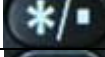
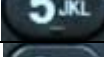
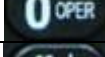
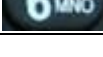
6.2. Digit-character map table

Keypad	Character	Keypad	Character
	1 @		7 P Q R S p q r s
	2 A B C a b c		8 T U V t u v
	3 D E F d e f		9 W X Y Z w x y z
	4 G H I g h i		*./
	5 J K L j k l		0
	6 M N O m n o		#/=