



Quick Installation Guide

802.11n Unified Access Point

This document will guide you through the basic installation process for your new D-Link Unified Wireless Access Point.

DWL-2600AP

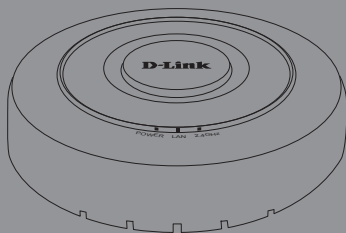

About This Guide

This installation guide provides basic instructions for installing the DWL-2600AP Wireless Access Point on your network. For additional information about how to use the Access Point, please see the User Manual, which is available on the CD included in this package or from the D-Link support website.

System Requirements

- CD-ROM Drive
- Windows®, Macintosh®, or Linux-based operating system
- Ethernet port or installed Ethernet adapter
- Internet Explorer 7.0, Safari 5.0, Firefox 4.0, or higher

Unpacking the Product

Open the shipping carton and carefully unpack its contents. Please consult the packing list located in following information to make sure all items are present and undamaged. If any item is missing or damaged, please contact your local D-Link reseller for replacement.

- DWL-2600AP 802.11n Unified Access Point
- Power Adapter
- Mounting Ring
- Ethernet Cable
- Console Cable*
- CD-ROM
- Ceiling Bracket (3 sets, sizes are 9/16", 14/16", and 1 1/2")

Note: Using a power supply with a different voltage than the one included with the DWL-2600AP may cause damage and will void the warranty for this product.

*The console cable is an optional accessory and not included in the package in Armenia, Azerbaijan, Belarus, Georgia, Israel, Kaliningrad, Kazakhstan, Kyrgyzstan, Latvia, Lithuania, Moldova, Mongolia, Russia, Turkey, Turkmenistan, Ukraine, and Uzbekistan. If a cable is required, please contact your reseller to order it (Model: ACS-AP-CONSOLE).

Optional Accessories

- PoE Base Unit (Model: DPE-101GI)

Note: These accessories are not included in the package. If any of these items are required, please contact your reseller to order it.

Hardware Overview

LEDs

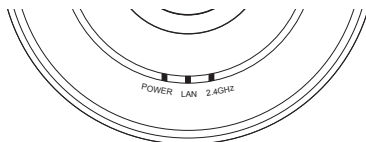

Figure 1. DWL-2600AP LEDs

- 2.4 GHz** – When this LED is lit up, the access point's 2.4 GHz radio is enabled. It will blink when there is wireless traffic.
- LAN** – When this LED is lit up, the device's Ethernet port is connected to an active router or switch. The light will blink when there is traffic going through the port.
- POWER** – When the LED is lit up, the access point is powered and ready for use.

Interfaces

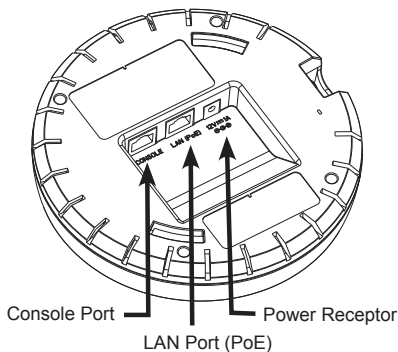
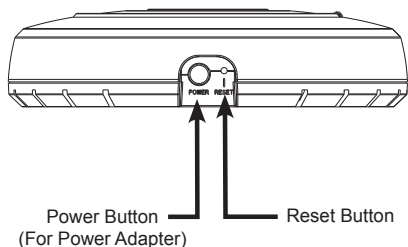

Figure 2. DWL-2600AP Rear Panel



Installation

Power on the access point

To power on the DWL-2600AP, you can use ONE of the following methods:

1. Connect the supplied power adapter
OR
2. Plug one end of an Ethernet cable into the LAN port of the DWL-2600AP and the other end into a port on a PoE switch.

Configure the access point

To set up and manage the DWL-2600AP, use one of the following methods:

- Manage the access point from the computer: Connect the access point and your computer directly via a straight-through Ethernet cable.



- Manage the access point from the computer via the Switch or Router: Connect the access point and your computer to the same switch or router.



- Manage the access point from the computer via the Unified Wireless Switch or Wireless Controller: Connect the access point to a Unified Wireless Switch or Wireless Controller. Connect your computer to the same network as that of the Unified Wireless Switch or Wireless Controller.

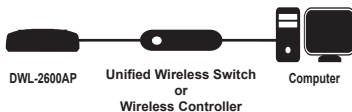

Mounting Options

You can mount a DWL-2600AP access point on any of the following types of surfaces:

- Solid surface wall or ceiling
- Tabletop

Cable Requirement

Use a CAT 5 cable with an even sheath.

The Ethernet ports on the DWL-2600AP access point cannot accept a CAT 5 cable that has an uneven sheath; the RJ-45 connector on the cable will not fit properly into the receptacle on the access point.

Wall Installation Recommendations

If you plan to install the DWL-2600AP on a wall or other vertical surfaces, orient the top of the access point (the side with the LEDs) toward the intended coverage area. The radio antennas transmit through the top of the access point but not through the bottom (where the bracket is).

Warning: The DWL-2600AP is designed to receive PoE power only from an 802.3af-compliant source, or from a D-Link-approved power injector. Connecting an access point to a Power over Ethernet (PoE) device that is not approved by D-Link can damage the equipment.

Mounting Using Anchor Screws

Installation

1. Place the plastic wall mounting ring on a wall or ceiling.
2. Mark the points where you will insert the screws. Take out the mounting ring.
3. Drill holes in the marked points and insert the plastic wall anchors.
4. Use the supplied screws to attach the mounting ring to the wall.

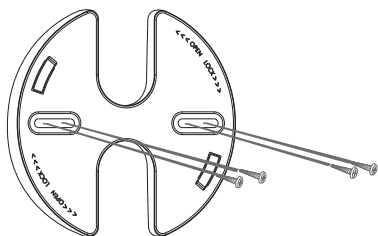

5. Plug the CAT 5 cable into the LAN port on the access point.

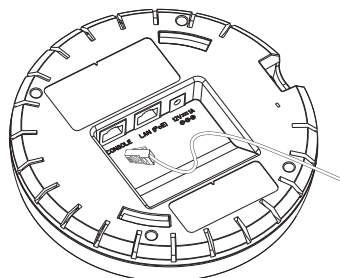

6. To attach the access point to the mounting ring, first locate the right side of the access point that has a small lock symbol on it, and make sure to line up this side with the side of the mounting ring that has Open - Lock written on it.

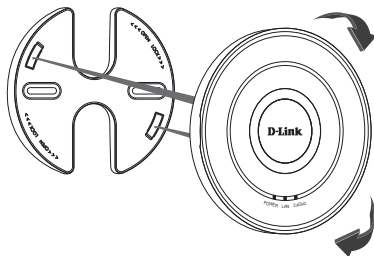

7. Twist clockwise to lock the access point onto the ring. The lock symbol on the access point must point directly to the **Close** text on the mounting ring.

Mounting Using Ceiling Bracket

Installation

1. Clip two ceiling brackets on the ceiling panels. Make sure both brackets are parallel.

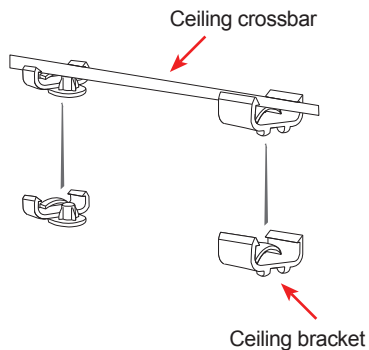

2. Use the provided screws to attach the mounting ring to the ceiling bracket.

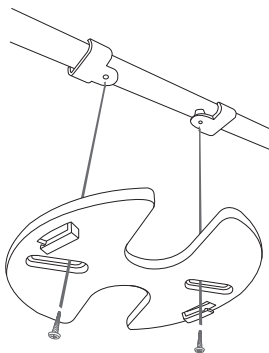

3. Plug the CAT 5 cable into the LAN port on the access point.

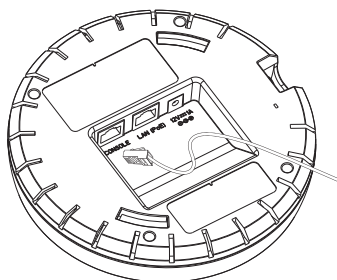

4. Place the DWL-2600AP's male bracket in the mounting ring's female bracket. Rotate the product clockwise to lock it in position.

