

DWL-3260AP
Release 1.00

Wireless Managed AP



User Manual

Business Class Networking

Table of Contents

Table of Contents	2
Package Contents	3
Introduction	4
Features and Benefits	6
Wireless Basics	7
Three Operational Modes	10
Getting Started	11
Using the Configuration Menu	13
Using the AP Manager	54
Networking Basics	84
Troubleshooting	100
Technical Specifications	106

Package Contents



- **D-Link AirPremier™ DWL-3260AP**
Managed Wireless Access Point
- Power over Ethernet base unit
- Power Adapter-DC 48V, 0.4A
- Power Cord
- Manual and Warranty on CD
- Quick Installation Guide
- Ethernet Cable
- Mounting Plate

Note: Using a power supply with a different voltage than the one included with the **DWL-3260AP** will cause damage and void the warranty for this product.

If any of the above items are missing, please contact your reseller.

Minimum System Requirements

- Computers with Windows®, Macintosh®, or Linux-based operating systems with an installed Ethernet Adapter
- Internet Explorer version 6.0 or Netscape Navigator™ version 7.0 and above

Introduction

The D-Link AirPremier DWL-3260AP is a powerful and reliable wireless access point for business-class enterprise environments. Designed for indoor installation, this access point provides advanced functions including 108Mbps Turbo speed, security, Quality of Service (QoS), and Power over Ethernet (PoE) for network administrators to deploy a highly manageable and robust wireless network.

Up to 108Mbps Wireless Speed. The DWL-3260AP delivers reliable wireless performance with standard 802.11g wireless throughput rates of up to 54Mbps. It has the added capability of reaching maximum wireless signal rates of up to 108Mbps (Turbo mode) powered by D-Link 108G technology. At the same time, the DWL-3260AP remains fully compatible with the IEEE 802.11b and 802.11g standards.

Power Over Ethernet Support. For maximum coverage, the DWL-3260AP can be placed at out-of-the-way locations such as on a ceiling, using a mounting plate. Industry-standard 802.3af PoE support facilitates installation of this device on high places, where AC outlets are inaccessible and providing power to these locations is difficult and expensive. From the ceiling, the DWL-3260AP can obtain power from a PoE switch located as far as 100 meters away through the unused pairs of the existing network cable, doing away with the need to install separate power wiring.

Ceiling Mounting. The DWL-3260AP has a round shape and can be camouflaged as a smoke detector to distract the attention of network intruders. Its diagnostic LED can be turned off to make it appear even more like a smoke detector.

Advanced Wireless Security. Since wireless security remains a strong concern among businesses, the DWL-3260AP provides the latest wireless security technologies by supporting both WPA/WPA2-Enterprise and 802.1x to ensure complete network protection. In addition, the DWL-3260AP currently comes 802.11i-ready to fully support industrial grade wireless security. Other security features included in this Access Point are MAC Address Filtering, Wireless LAN segmentation, Broadcast SSID Disabled, and support for Advanced Encryption Standard (AES) data encryption.

WDS (Wireless Distribution System) Support. To maximize total return on investment, the DWL-3260AP can be configured to operate as an access point (AP mode), a point-to-point bridge or a point-to-multipoint bridge (WDS mode). In the AP mode, the DWL-3260AP uses its built-in omni-directional antenna for multi-angle coverage. In the WDS mode, the DWL-3260AP can be mounted on a high wall and externally fitted with an optional directional antenna through its SMA connector. Users will disable the built-in antenna through a slide switch, and the DWL-3260AP will communicate only with wireless bridges, using the external directional antenna, without allowing wireless clients or workstations to access them.

**Maximum wireless signal rate derived from IEEE Standard 802.11g specifications. Actual data throughput will vary. Network conditions and environmental factors, including volume of network traffic, building materials and construction, and network overhead lower actual data throughput rate.

Increased Network Flexibility and Efficiency. The DWL-3260AP supports multiple SSIDs, allowing you to separate applications based on security and performance requirements. You can enable encryption and authentication on one SSID to protect private applications and no security on another SSID to maximize open connectivity for public usage. Multiple SSIDs means you can mix and match the broadcasting of SSIDs. For public Internet access applications, you can broadcast the SSID to enable user radio cards to automatically find available access points. For private applications, you can disable SSID broadcast to prevent intruders from identifying your network. You can set the number of users that can associate via a particular SSID to control usage of particular applications. This can help provide a somewhat limited form of bandwidth control for particular applications.

Cost Saving and Mobile Applications. By supporting multiple SSIDs, the DWL-3260AP allows you to logically divide your access point into several virtual access points all within a single hardware platform. Rather than having two separate WLANs, you can deploy one access point to support more than one application, such as public Internet access and internal network control to increase flexibility and keep costs down.

Advanced Network Management. Network administrators can manage all the DWL-3260AP's settings via its web-based configuration utility or with Telnet. For advanced network management, the administrators can use D-Link's AP Manager or D-View SNMP management module to configure and manage multiple access points from a single location. In addition to a streamlined management process, network administrators can also verify and conduct regular maintenance checks without wasting resources by sending personnel out to physically verify proper operation.

Features and Benefits

- **For Business-Class Environments** - The DWL-3260AP is in smoke detector shape that is ideal for mounting on ceiling or other indoor deployments. It also comes with an optional RP-SMA external directional antenna for communicating with another DWL-3260AP.
- **3 Different Operation modes** - Capable of operating in one of three different operation modes to meet your wireless networking requirements: Access Point; WDS with AP, or WDS.
- **Easy Installation with PoE (Power over Ethernet).**
- **Faster wireless networking** with the 802.11g standard to provide a maximum wireless signal rate of up to 54Mbps* (maximum wireless signal rate of up to 108Mbps* in Super G mode).
- **Compatible with the 802.11b standard** to provide a wireless data rate of up to 11Mbps - that means you can migrate your system to the 802.11g standard on your own schedule without sacrificing connectivity.
- **Better security with WPA** - The DWL-3260AP can securely connect wireless clients on the network using WPA (Wi-Fi Protected Access) providing a much higher level of security for your data and communications than has previously been available.
- **AP Manager Setup Wizard** - The new Setup Wizard makes network configuration quick and simple.
- **SNMP for Management** - The DWL-3260AP is not just fast but it also supports SNMP v.3 for a better network management. Superior wireless AP manager software is bundled with the DWL-3260AP for network configuration and firmware upgrade. Systems administrators can also setup the DWL-3260AP easily with the Web-based configuration. A D-Link D-View module will be downloadable for network administration and real-time network traffic monitoring with D-Link D-View software.
- Utilizes **OFDM** technology (**O**rtogonal **F**requency **D**ivision **M**ultiplexing).
- Operates in the 2.4GHz frequency range.
- **Web-based interface** for managing and configuring.

*"Maximum wireless signal rate derived from IEEE Standard 802.11a and 802.11g specifications. Actual data throughput will vary. Network conditions and environmental factors, including volume of network traffic, building materials and construction, and network overhead lower actual data throughput rate."

Wireless Basics

D-Link wireless products are based on industry standards to provide easy-to-use and compatible high-speed wireless connectivity within your home, business or public access wireless networks. D-Link wireless products will allow you access to the data you want, when and where you want it. You will be able to enjoy the freedom that wireless networking brings.

A Wireless Local Area Network (WLAN) is a computer network that transmits and receives data with radio signals instead of wires. WLANs are used increasingly in both home and office environments, and public areas such as airports, coffee shops and universities. Innovative ways to utilize WLAN technology are helping people to work and communicate more efficiently. Increased mobility and the absence of cabling and other fixed infrastructure have proven to be beneficial for many users.

Wireless users can use the same applications they use on a wired network. Wireless adapter cards used on laptop and desktop systems support the same protocols as Ethernet adapter cards.

People use WLAN technology for many different purposes:

Mobility - Productivity increases when people have access to data in any location within the operating range of the WLAN. Management decisions based on real-time information can significantly improve worker efficiency.

Low Implementation Costs - WLANs are easy to set up, manage, change and relocate. Networks that frequently change can benefit from WLANs ease of implementation. WLANs can operate in locations where installation of wiring may be impractical.

Installation and Network Expansion - Installing a WLAN system can be fast and easy and can eliminate the need to pull cable through walls and ceilings. Wireless technology allows the network to go where wires cannot go - even outside the home or office.

Inexpensive Solution - Wireless network devices are as competitively priced as conventional Ethernet network devices. The DWL-3260AP saves money by providing multi-functionality, configurable in one of four different modes.

Scalability - WLANs can be configured in a variety of ways to meet the needs of specific applications and installations. Configurations are easily changed and range from Peer-to-Peer networks suitable for a small number of users to larger Infrastructure networks to accommodate hundreds or thousands of users, depending on the number of wireless devices deployed.

Standards-Based Technology

The DWL-3260AP Managed Wireless Access Point utilizes the **802.11b** and the **802.11g** standards.

The IEEE **802.11g** standard is an extension of the **802.11b** standard. It increases the maximum wireless signal rate of up to 54Mbps* (maximum wireless signal rate of up to 108Mbps* in Super G mode) within the 2.4GHz band, utilizing **OFDM technology**.

This means that in most environments, within the specified range of this device, you will be able to transfer large files quickly or even watch a movie in MPEG format over your network without noticeable delays. This technology works by transmitting high-speed digital data over a radio wave utilizing **OFDM (Orthogonal Frequency Division Multiplexing)** technology. **OFDM** works by splitting the radio signal into multiple smaller sub-signals that are then transmitted simultaneously at different frequencies to the receiver. **OFDM** reduces the amount of **crosstalk** (interference) in signal transmissions.

The D-Link DWL-3260AP will automatically sense the best possible connection speed to ensure the greatest speed and range possible.

802.11g offers the most advanced network security features available today, including WPA and WPA2.

**Maximum wireless signal rate derived from IEEE Standard 802.11g specifications. Actual data throughput will vary. Network conditions and environmental factors, including volume of network traffic, building materials and construction, and network overhead lower actual data throughput rate.

The D-Link *AirPremier* DWL-3260AP lets you access your network, using a wireless connection, from virtually anywhere within its operating range. Keep in mind, however, that the number, thickness and location of walls, ceilings, or other objects that the wireless signals must pass through, may limit the range. Typical ranges vary depending on the types of materials and background RF (radio frequency) noise in your home or business. The key to maximizing wireless range is to follow these basic guidelines:

- 1** Keep the number of walls and ceilings between the DWL-3260AP and other network devices to a minimum - each wall or ceiling can reduce your DWL-3260AP's range from 3-90 feet (1-30 meters.) Position your devices so that the number of walls or ceilings is minimized.
- 2** Be aware of the direct line between network devices. A wall that is 1.5 feet thick (.5 meters), at a 45-degree angle appears to be almost 3 feet (1 meter) thick. At a 2-degree angle it looks over 42 feet (14 meters) thick! Position devices so that the signal will travel straight through a wall or ceiling (instead of at an angle) for better reception.
- 3** Building materials can impede the wireless signal - a solid metal door or aluminum studs may have a negative effect on range. Try to position wireless devices and computers with wireless adapters so that the signal passes through drywall or open doorways and not other materials.
- 4** Keep your product away (at least 3-6 feet or 1-2 meters) from electrical devices or appliances that generate RF noise.

Three Operational Modes

Operation Mode (Only supports 1 mode at a time)	Function
Access Point (AP)	Create a Wireless LAN
WDS with AP	Wirelessly Connect Multi Networks While still Functioning as a Wireless AP
WDS	Wirelessly Connect Multi Networks

Getting Started

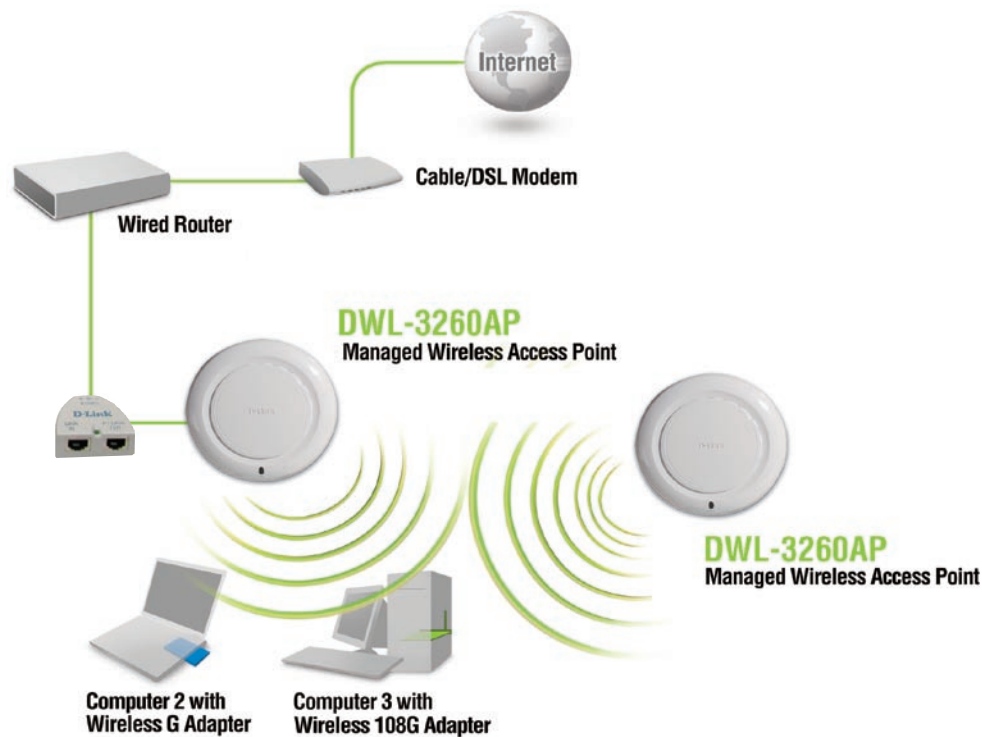

- 1 You will need broadband Internet access.
- 2 Consult with your Cable or DSL provider for proper installation of the modem.
- 3 Connect the Cable or DSL modem to a Router.
(See the printed Quick Installation Guide included with your router.)
- 4 Connect the Ethernet Broadband Router to the PoE base unit.
(See the printed Quick Installation Guide included with the DWL-3260AP.)
- 5 Connect the DWL-3260AP to the PoE base unit.
(See the printed Quick Installation Guide included with the DWL-3260AP.)
- 6 If you are connecting a desktop computer to your network, install the D-Link WDA-2320 wireless PCI adapter into an available PCI slot on your desktop computer.
(See the printed Quick Installation Guide included with the network adapter.)
- 7 Install the drivers for the D-Link WNA-2330 wireless Cardbus adapter into a laptop computer.
(See the printed Quick Installation Guide included with the WNA-2330.)

Connecting PoE (Power over Ethernet)

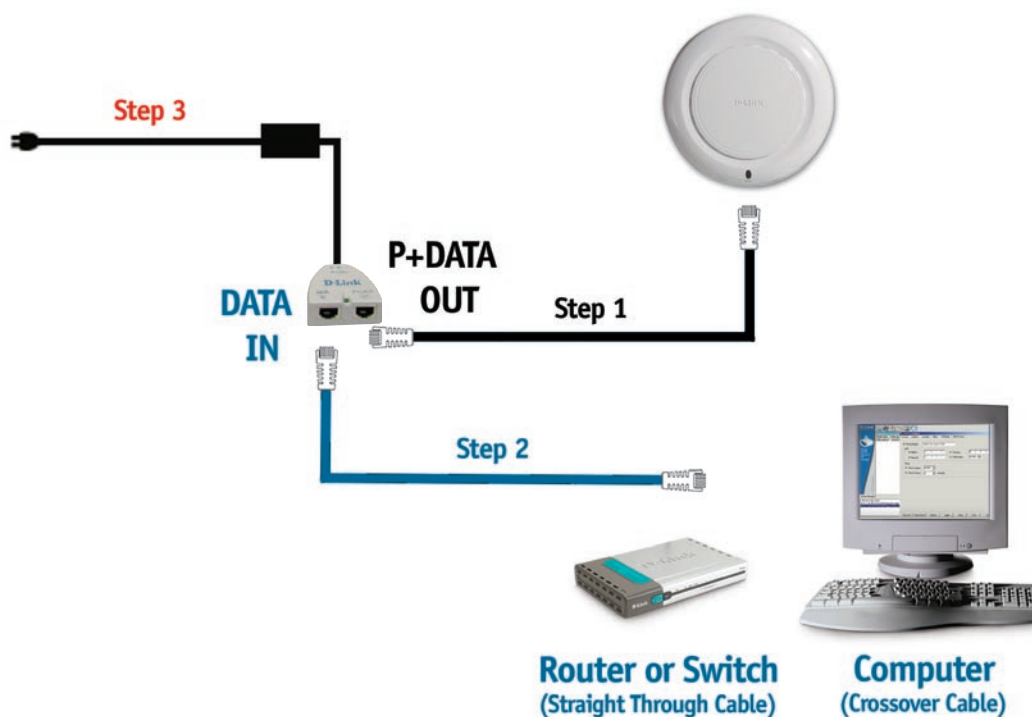

- Step 1** Connect one end of an Ethernet cable (included with your package) to the **LAN port** on the DWL-3260AP and the other end of the Ethernet cable to the port labeled **P+DATA OUT** on the PoE base unit.
- Step 2** Connect another Ethernet cable from the **DATA IN** port on the PoE base unit to your router/switch, using a straight through cable, or to a PC, using a crossover cable.
- Step 3** Attach the power adapter to the connector labeled **POWER IN** on the PoE base unit. Attach the power cord to the power adapter and into an electrical outlet.

Using the Configuration Menu

To configure the DWL-3260AP, use a computer which is connected to the DWL-3260AP with an Ethernet cable (see the *Network Layout* diagram).

First, disable the **Access the Internet using a proxy server** function. To disable this function, go to **Control Panel > Internet Options > Connections > LAN Settings** and uncheck the enable box.

Start your web browser program (Internet Explorer, Netscape Navigator™) .

Type the IP address and http port of the DWL-3260AP in the address field (http://192.168.0.50) and press **Enter**. Make sure that the IP addresses of the DWL-3260AP and your computer are in the same subnet.

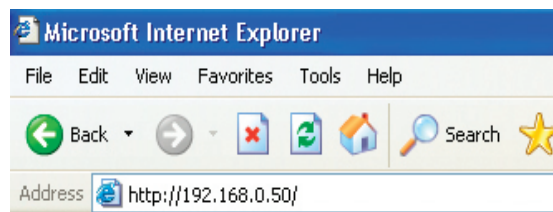

After the connection is established, you will see the user identification window as shown.

Note: If you have changed the default IP address assigned to the DWL-3260AP, make sure to enter the correct IP address.

- Type **admin** in the **User Name** field
- Leave the **Password** field blank
- Click **OK**



Note: If you have changed the password, make sure to enter the correct password.

After successfully logging into the DWL-3260AP the following screen appears:

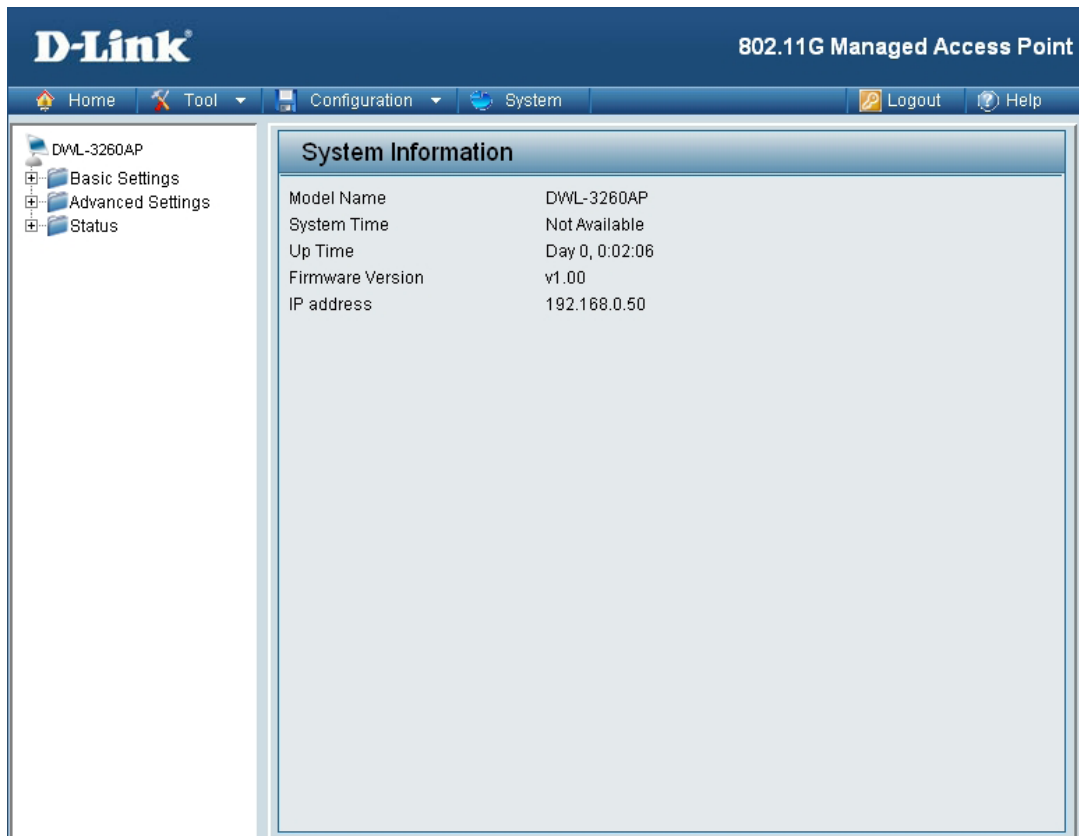

When making changes on most of the configuration screens in this section, use the Apply button at the bottom of each screen to save your configuration changes.

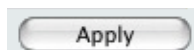

Click to apply configuration changes.

Home > Basic Settings > Wireless

The screenshot shows the D-Link configuration interface for a DWL-3260AP. The page title is "802.11G Managed Access Point". The navigation menu includes Home, Tool, Configuration, System, Logout, and Help. The left sidebar shows a tree view with Basic Settings (Wireless, LAN), Advanced Settings, and Status. The main content area is titled "Wireless Settings" and contains the following fields:

- Wireless Band: IEEE802.11g
- Mode: Access Point
- Wireless Network Name (SSID): dlink
- SSID Broadcast: Enable
- Channel: 1, 2.412 GHz, Auto Channel Scan (checked)
- Authentication: Open System
- Key Settings:
 - Encryption: Disable, Enable
 - Key Type: HEX, Key Size: 64 Bits
 - Valid Key: First
 - First Key: [Redacted]
 - Second Key: [Redacted]
 - Third Key: [Redacted]
 - Fourth Key: [Redacted]

An "Apply" button is located at the bottom right of the configuration area.

Wireless Band: IEEE 802.11g

Mode: Access Point is selected from the pull-down menu.

SSID: Service Set Identifier (SSID) is the name designated for a specific wireless local area network (WLAN). The SSID's factory default setting is **dlink**. The SSID can be easily changed to connect to an existing wireless network or to establish a new wireless network. The SSID can be up to 32 characters and is case-sensitive.

SSID Broadcast: Enable or Disable SSID broadcast. Enabling this feature broadcasts the SSID across the network.

Channel: **Auto Channel Scan** is set by default. All devices on the network must share the same channel. To change the channel, uncheck Auto Channel Scan. (Note: The wireless adapters will automatically scan and match the wireless setting.)

Home > Basic Settings > Wireless (continued)

Auto Channel Scan: Select **Enable** or **Disable**. (Enable this feature to auto-select the channel for best wireless performance.)

Authentication:

- Open System**
- Shared Key**
- Open System/Shared Key**
- WPA-Enterprise**
- WPA-Personal**
- WPA2-Enterprise**
- WPA2-Personal**
- WPA-Auto-Enterprise**
- WPA-Auto-Personal**

Select **Open System** to communicate the key across the network.

Select **Shared Key** to limit communication to only those devices that share the same WEP settings.

Select **Open System/Shared Key** to allow either form of data encryption.

Select **WPA-Enterprise, WPA2-Enterprise, WPA-Auto-Enterprise** to secure your network with the inclusion of a RADIUS server.

Select **WPA-Personal, WPA2-Personal, WPA-Auto-Personal** to secure your network using a password and dynamic key changes. (No RADIUS server required).

Encryption: Select **Disabled** or **Enabled**. (**Disabled** is selected here).

Key Type*: Select **HEX** or **ASCII**.

Key Size: Select **64-, 128-, 152-**bits.

Valid Key: Select the 1st through the **4th** key to be the active key.

First through Fourth keys: Input up to **four keys** for encryption. You will select one of these keys in the valid key field.

**Hexadecimal digits consist of the numbers 0-9 and the letters A-F*

**ASCII (American Standard Code for Information Interchange) is a code for representing English letters as numbers from 0-127*

Home > Basic Settings > Wireless > WPA-Enterprise, WPA2-Enterprise, & WPA-Auto-Enterprise

The screenshot shows the D-Link configuration interface for a DWL-3260AP. The main content area is titled "Wireless Settings" and contains the following fields:

- Wireless Band: IEEE802.11g
- Mode: Access Point
- Wireless Network Name (SSID): dlink
- SSID Broadcast: Enable
- Channel: 1 (2.412 GHz), with the "Auto Channel Scan" checkbox checked.
- Authentication: WPA-Enterprise
- RADIUS Server Settings:**
 - Cipher Type: AUTO
 - Group Key Update Interval: 1800 Sec
 - RADIUS Server: [Empty text box]
 - RADIUS Port: 1812
 - RADIUS Secret: [Empty text box]
 - Accounting Mode: Disable
 - Accounting Server: [Empty text box]
 - Accounting Port: 1813

An "Apply" button is located at the bottom right of the configuration area.

Cipher Type: When you select **WPA-Enterprise**, you must select **AUTO**, **AES**, or **TKIP** from the pull down menu.

Group Key Update Interval: Select the interval during which the group key will be valid. 1800 is the recommended value. A lower interval may reduce data transfer rate.

RADIUS Server: Enter the IP address of the RADIUS server.

RADIUS Port: Enter the RADIUS port.

RADIUS Secret: Enter the RADIUS secret.

Accounting Mode: Select if you want to use a different server for accounting.

Accounting Server: Enter the IP address of the Accounting server.

Accounting Port: Enter the Accounting port (1813 is default).

Home > Basic Settings > Wireless > WPA-Personal, WPA2-Personal, & WPA-Auto-Personal

The screenshot shows the D-Link configuration interface for a DWL-3260AP. The page title is "802.11G Managed Access Point". The navigation menu includes Home, Tool, Configuration, System, Logout, and Help. The left sidebar shows a tree view with Basic Settings (Wireless, LAN), Advanced Settings, and Status. The main content area is titled "Wireless Settings" and contains the following fields:

- Wireless Band: IEEE802.11g
- Mode: Access Point
- Wireless Network Name (SSID): dlink
- SSID Broadcast: Enable
- Channel: 1, 2.412 GHz, Auto Channel Scan
- Authentication: WPA-Personal
- PassPhrase Settings:
 - Cipher Type: AUTO
 - Group Key Update Interval: 1800 Sec
 - PassPhrase: (empty text box)

An "Apply" button is located at the bottom right of the settings area.

Cipher Type: When you select **WPA-Personal**, please select **AUTO**, **AES**, or **TKIP** from the pull down menu.

Group Key Update Interval: Select the interval during which the group key will be valid. The default value of 1800 is recommended.

PassPhrase: When you select **WPA-Personal**, please enter a **PassPhrase** in the corresponding field.

Home > Basic Settings > Wireless > WDS with AP mode

The screenshot shows the configuration interface for a DWL-3260AP. The left sidebar contains a tree view with 'Basic Settings' expanded to 'Wireless'. The main content area is titled 'Wireless Settings' and contains the following fields and sections:

- Wireless Band:** IEEE802.11g
- Mode:** WDS with AP
- Wireless Network Name (SSID):** dlink
- SSID Broadcast:** Enable
- Channel:** 1 (2.412 GHz), with an unchecked 'Auto Channel Scan' checkbox.
- WDS with AP:** A section containing 'Remote AP MAC Address' fields (1-8) and a 'Site Survey' section with a 'Scan' button.
- Authentication:** WPA-Personal
- PassPhrase Settings:**
 - Cipher Type:** AUTO
 - Group Key Update Interval:** 1800 Sec
 - PassPhrase:** (empty text field)

An 'Apply' button is located at the bottom right of the configuration area.

In WDS with AP mode, the DWL-3260AP wirelessly connects multiple networks, while still functioning as a wireless AP.

Wireless Band: IEEE 802.11g

Mode: WDS with AP mode is selected from the pull-down menu.

SSID: Service Set Identifier (SSID) is the name designated for a specific wireless local area network (WLAN). The SSID's factory default setting is **dlink**. The SSID can be easily changed to connect to an existing wireless network or to establish a new wireless network.

SSID Broadcast: Enable or Disable SSID broadcast. Enabling this feature broadcasts the SSID across the network.

Home > Basic Settings > Wireless > WDS with AP (continued)

Channel:	6 is the default channel. All devices on the network must share the same channel. (Note: The wireless adapters will automatically scan and match the wireless setting.)
Auto Channel Scan:	Click on the Scan button to search for available wireless networks. Click on the network you want to connect to.
Remote AP MAC Address:	Select Enable or Disable. (Enable this feature to auto-select the channel for best wireless performance.)
WDS Site Survey:	Enter the MAC addresses of the APs in your network that will serve as bridges to wirelessly connect multiple networks.
Authentication:	Open System Shared Key Open System/Shared Key WPA-Personal WPA2-Personal WPA-Auto-Personal Select Open System to communicate the key across the network. Select Shared Key to limit communication to only those devices that share the same WEP settings. Select Open System/Shared Key to allow either form of data encryption. Select WPA-Personal , WPA2-Personal , or WPA-Auto-Personal to secure your network using a password and dynamic key changes. (No RADIUS Server required).

Home > Basic Settings > Wireless > WDS mode

The screenshot shows the configuration interface for a DWL-3260AP. The left sidebar contains a tree view with 'Basic Settings' expanded to 'Wireless'. The main content area is titled 'Wireless Settings' and contains the following fields and sections:

- Wireless Band:** IEEE802.11g
- Mode:** WDS
- Wireless Network Name (SSID):** dlink
- SSID Broadcast:** Enable
- Channel:** 1 (2.412 GHz) with an 'Auto Channel Scan' checkbox.
- WDS Section:**
 - Remote AP MAC Address:** Eight input fields numbered 1 through 8.
 - Site Survey:** A table with columns 'Type', 'CH', 'Signal', 'BSSID', 'Security', and 'SSID'. A 'Scan' button is located to the right of the table.
- Authentication:** WPA-Personal
- PassPhrase Settings:**
 - Cipher Type:** AES
 - Group Key Update Interval:** 1800 Sec
 - PassPhrase:** An empty text input field.

An 'Apply' button is located at the bottom right of the configuration area.

In WDS mode, the DWL-3260AP wirelessly connects multiple networks, without functioning as a wireless AP.

Wireless Band: IEEE 802.11g

Mode: WDS is selected from the pull-down menu.

SSID: Service Set Identifier (SSID) is the name designated for a specific wireless local area network (WLAN). The SSID's factory default setting is default. The SSID can be easily changed to connect to an existing wireless network or to establish a new wireless network.

SSID Broadcast: Enable or Disable SSID broadcast. Enabling this feature broadcasts the SSID across the network.

Channel:	6 is the default channel. All devices on the network must share the same channel.
Auto Channel Scan:	Select Enable or Disable . (Enable this feature to auto-select the channel for best wireless performance.)
Remote AP MAC Address:	Enter the MAC addresses of the APs in your network that will serve as bridges to wirelessly connect multiple networks.
WDS Site Survey:	Click on the Scan button to search for available wireless networks. Click on the network you want to connect to.
Authentication:	Open System Shared Key Open System/Shared Key WPA-Personal WPA2-Personal WPA-Auto-Personal Select Open System to communicate the key across the network. Select Shared Key to limit communication to only those devices that share the same WEP settings. Select Open System/Shared Key to allow either form of data encryption. Select WPA-Personal , WPA2-Personal , or WPA-Auto-Personal to secure your network using a password and dynamic key changes. (No RADIUS Server required).

Home > Wireless Modes

AP Mode	Authentication Available
Access Point	Open System Shared Key Open System/Shared Key WPA-Enterprise WPA-Personal WPA2-Enterprise WPA2-Personal WPA-Auto-Enterprise WPA-Auto-Personal
WDS with AP	Open System Shared Key Open System/Shared Key WPA-Personal WPA2-Personal WPA-Auto-Personal
WDS	Open System Shared Key Open System/Shared Key WPA-Personal WPA2-Personal WPA-Auto-Personal

Home > Basic Settings > LAN

The screenshot shows the D-Link configuration web interface for a DWL-3260AP. The page title is "802.11G Managed Access Point". The navigation menu includes Home, Tool, Configuration, System, Logout, and Help. The left sidebar shows a tree view with "Basic Settings" expanded to "LAN". The main content area is titled "LAN Settings" and contains the following fields:

Get IP From	Static (Manual)
IP address	192.168.0.50
Subnet Mask	255.255.255.0
Default Gateway	0.0.0.0

An "Apply" button is located at the bottom right of the form.

LAN is short for Local Area Network. This is considered your internal network. These are the IP settings of the LAN interface for the DWL-3260AP. These settings may be referred to as private settings. You may change the LAN IP address if needed. The LAN IP address is private to your internal network and cannot be seen on the Internet.

Get IP From: Static (Manual) is chosen here. Choose this option if you do not have a DHCP server in your network, or if you wish to assign a static IP address to the DWL-3260AP. When DHCP is selected the other fields here will be greyed out.

IP Address: The default IP address is 192.168.0.50. Assign a static IP address that is within the IP address range of your network.

Subnet Mask: Enter the subnet mask. All devices in the network must share the same subnet mask.

Default Gateway: Enter the IP address of the gateway in your network. If there isn't a gateway in your network, please enter an IP address within the range of your network.

Home > Advanced Settings > Performance

D-Link 802.11G Managed Access Point

Home Tool Configuration System Logout Help

Advanced Wireless Settings

Wireless Band	IEEE802.11g
Frequency	2.412 GHz
Channel	1
Data Rate	Auto
Beacon Interval (20 - 1000)	100
DTIM (1 - 255)	1
Fragment Length (256 - 2346)	2346
RTS Length (256 - 2346)	2346
Transmit Power	Full
Super Mode	Disable
Radio	On
WMM	Enable
Preamble	Short and Long
Wireless B/G Mode	Mixed

Apply

Wireless Band: IEEE 802.11g.

Frequency: The frequency reflects the choice of the wireless channel. When IEEE 802.11g is chosen the frequency is 2.437GHz for channel 6.

Channel: The default channel for IEEE 802.11g is 6.

Data Rate*: **The Data Rates** are Auto, 6Mbps, 9Mbps, 12Mbps, 18Mbps, 24Mbps, 36Mbps, 48Mbps, 54Mbps.

Beacon Interval: Beacons are packets sent by an access point to synchronize a network. Specify a beacon interval value. The default (100) is recommended.

DTIM: (*Delivery Traffic Indication Message*) - Select a setting between 1 and 255. 1 is the default setting. DTIM is a countdown informing clients of the next window for listening to broadcast and multicast messages.

**Maximum wireless signal rate based on IEEE Standard 802.11a and 802.11g specifications. Actual data throughput will vary. Network conditions and environmental factors, including volume of network traffic, building materials and construction, and network overhead lower actual data throughput rate.

Fragment Length:	The fragmentation threshold, which is specified in bytes, determines whether packets will be fragmented. Packets exceeding the 2346 byte setting will be fragmented before transmission. 2346 is the default setting						
RTS Length:	This value should remain at its default setting of 2346. If you encounter inconsistent data flow, only minor modifications to the value range between 256 and 2346 are recommended						
Transmit Power:	Choose full, half (-3dB), quarter (-6dB), eighth (-9dB), minimum power.						
Super G Mode:	<p>Super G is a group of performance enhancement features that increase end user application throughput in an 802.11g network. Super G is backwards compatible to standard 802.11g devices. For top performance, all wireless devices on the network should be Super G capable. Select either Disabled, Super G without Turbo, or Super G with Dynamic Turbo.</p> <table border="0" style="width: 100%;"> <tr> <td style="vertical-align: top;">Disabled:</td> <td>Standard 802.11g support, no enhanced capabilities.</td> </tr> <tr> <td style="vertical-align: top;">Super G without Turbo:</td> <td>Capable of Packet Bursting, FastFrames, Compression, and no Turbo mode.</td> </tr> <tr> <td style="vertical-align: top;">Super G with Dynamic Turbo:</td> <td>Capable of Packet Bursting, FastFrames, Compression, and Dynamic Turbo. This setting is backwards compatible with non-Turbo (legacy) devices. Dynamic Turbo mode is only enabled when all devices on the wireless network are configured with Super G with Dynamic Turbo enabled.</td> </tr> </table>	Disabled:	Standard 802.11g support, no enhanced capabilities.	Super G without Turbo:	Capable of Packet Bursting, FastFrames, Compression, and no Turbo mode.	Super G with Dynamic Turbo:	Capable of Packet Bursting, FastFrames, Compression, and Dynamic Turbo. This setting is backwards compatible with non-Turbo (legacy) devices. Dynamic Turbo mode is only enabled when all devices on the wireless network are configured with Super G with Dynamic Turbo enabled.
Disabled:	Standard 802.11g support, no enhanced capabilities.						
Super G without Turbo:	Capable of Packet Bursting, FastFrames, Compression, and no Turbo mode.						
Super G with Dynamic Turbo:	Capable of Packet Bursting, FastFrames, Compression, and Dynamic Turbo. This setting is backwards compatible with non-Turbo (legacy) devices. Dynamic Turbo mode is only enabled when all devices on the wireless network are configured with Super G with Dynamic Turbo enabled.						
Radio:	Select On or Off .						
WMM:	Select Enable or Disable , Disable is selected by default. WMM stands for Wi-Fi Multimedia, by enabling this feature it will improve the user experience for audio and video applications over a Wi-Fi network.						
Preamble:	Select the default value Short and Long , or Long Only .						
Wireless B/G Mode:	This function allows you to configure the wireless network with IEEE 802.11g only, IEEE 802.11b only, or IEEE 802.11g with backward interoperability with IEEE 802.11b.						
Antenna Diversity:	The DWL-3260AP supports 2.4GHz radio with two antennas. Radio is connected to each antenna and supports auto diversity mode by default. This means that the access point will auto switch to the antenna with better RSSI value.						

Antenna Diversity (continued): Diversity: The DWL-3260AP will auto switch to the antenna with better RSSI value.

Left Antenna: The AP will not switch antenna and the radio will use the left antenna (when facing the AP) to transmit and receive packets.

Right Antenna: AP won't switch antenna and the radio will use the right antenna (when facing the AP) to transmit and receive packets.

Home > Advanced Settings > Grouping

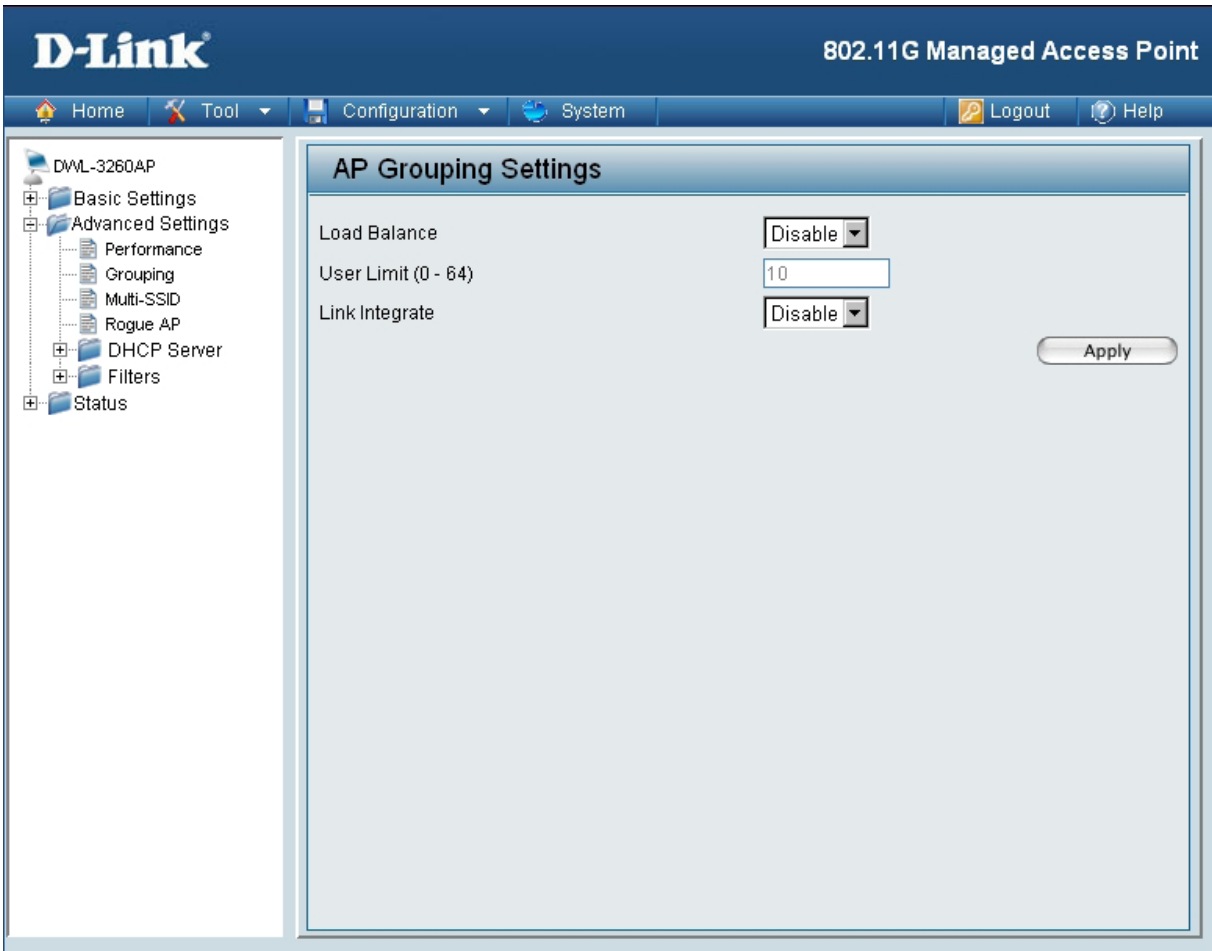

- Load Balance:** Load Balancing allows you to balance and share the wireless network traffic and clients using multiple DWL-3260APs. Select **Enable** or **Disable**.
- User Limit:** Sets the maximum amount of users allowed (0-64).
- Link Integrate:** If the Ethernet connection between the LAN and the DWL-3260AP is disconnected, the Link Integrate option will cause the wireless segment associated with the AP to be disconnected from the AP. Select **Enable** or **Disable**.
- Ethernet Link Status:** Displays the current link status of the DWL-3260AP Ethernet port.

Home > Advanced Settings > Multi-SSID

D-Link 802.11G Managed Access Point

Home Tool Configuration System Logout Help

DWL-3260AP

- Basic Settings
- Advanced Settings
 - Performance
 - Grouping
 - Multi-SSID
 - Rogue AP
- DHCP Server
- Filters
- Status

Multi-SSID Settings

Enable Multi-SSID Enable VLAN State

Wireless Settings

Band: IEEE802.11g

Index: Primary SSID

Wireless Network Name (SSID): 3260

SSID Broadcast: Enable

Security: None

VLAN ID: 1

WMM: Disable

Key Settings

Key Type: Hex

Key Size: 64 Bits

Key: 1

Apply

Index	SSID	Band	Encryption	VLAN ID	Delete
Primary	3260	11g	OFF	OFF	

If you want to configure the Guest and Internal networks on Virtual LAN (VLANs), the switch and DHCP server you are using must support VLANs. As a prerequisite step, configure a port on the switch for handling VLAN tagged packets as described in the IEEE802.1Q standard.

Enable Multi-SSID: Check to use Multi-SSID.

Enable VLAN Status: Check to use a VLAN.

Band: IEEE802.11g is selected.

Index: You can select up to 7 multi-SSIDs. The default multi-SSIDs is the primary, which puts the total to 8 multi-SSIDs.

SSID: Service Set Identifier (SSID) is the name designated for a specific wireless local area network (WLAN). The SSID's factory default setting is **default**. The SSID can be easily changed to connect to an existing wireless network or to establish a new wireless network.

Security: The Multi-SSIDs security can be WPA/WPA2-Enterprise or WPA-Auto-Enterprise only when the Primary SSID's security is at the same security level. Also, they must connect to the same RADIUS server.

VLAN ID: If you configure enable Guest access and configure Internal and Guest networks on VLANs, this field will be enabled.

Provide a number between 1 and 4094 for the Internal VLAN.

This will cause the access point to send DHCP requests with the VLAN tag. The switch and the DHCP server must support VLAN IEEE802.1Q frames. The access point must be able to reach the DHCP server.

Check with the Administrator regarding the VLAN and DHCP configurations.

Key Type: Select **HEX** or **ASCII**.

Key Size: Select **64-bit, 128-bit, or 152-bit**.

Key: Select the 1st key all the way through the 4th key, to be set as the active key. Enter key here.

When Primary SSID is set to any of the following security levels:	Multi-SSID can use any of these security levels:
None Open System (WEP) Shared Key (WEP) WPA-Personal WPA2-Personal WPA-Auto-Personal	None Open System (WEP) Shared Key (WEP) WPA-Personal WPA2-Personal WPA-Auto-Personal
WPA-Enterprise WPA2-Enterprise WPA-Auto-Enterprise	None Open System (WEP) Shared Key (WEP) WPA-Personal WPA2-Personal WPA-Auto-Personal WPA-Enterprise WPA2-Enterprise WPA-Auto-Enterprise

Note: If WPA or WPA2 is being used, it will occupy the key space 2 and 3, which will leave key 1 and 4 for other SSIDs to use for WEP.

When you configure one Multi-SSID, you must click **Save to Table** and then click Apply to save your settings.

Cipher Type:	When you select WPA-Personal , please select AUTO, AES , or TKIP from the pull down menu.
Group Key Update Interval:	Select the interval during which the group key will be valid. The default value of 1800 is recommended.
PassPhrase:	When you select WPA-Personal , please enter a PassPhrase in the corresponding field.

Home > Advanced Settings > Rogue AP

The screenshot shows the configuration page for a D-Link 802.11G Managed Access Point, specifically the 'Rogue AP Detection' section. The interface includes a navigation menu on the left and a main configuration area on the right.

BSS Type: Radio buttons for AP BSS (selected), Ad Hoc, and Both.

Band: Checkboxes for 11b and 11g.

Security: Checkboxes for OFF, WEP, WPA-Enterprise, WPA-Personal, WPA2-Enterprise, WPA2-Personal, WPA-Auto-Enterprise, and WPA-Auto-Personal.

Rogue AP List: A table with a 'Detect' button above it. The table columns are Type, CH, BSSID, Security, MODE, SSID, and Add Del.

Type	CH	BSSID	Security	MODE	SSID	Add Del
AP BSS	3	00:11:95:d8:de:a5	WPA2-Personal	802.11b	Home_11g	[Add] [Del] [Up]
AP BSS	9	00:13:46:90:54:ab	OFF	802.11g	D-Link	[Add] [Del]
AP BSS	9	00:13:46:90:54:56	OFF	802.11g	D-Link	[Add] [Del]
AP BSS	9	00:13:46:90:55:37	OFF	802.11g	D-Link	[Add] [Del]
AP BSS	9	00:0d:88:e6:53:26	OFF	802.11g	D-Link	[Add] [Del]
AP BSS	9	00:13:46:90:55:74	OFF	802.11g	D-Link	[Add] [Del] [Down]

AP List: A table with columns Type, CH, BSSID, Security, MODE, SSID, and Del. The table is currently empty.

An 'Apply' button is located at the bottom right of the configuration area.

BSS Type: The Basic Service Set Type allows you to select from **AP BSS**, **Ad Hoc**, or **Both**.

Band: Select the type of network (bands 11b and 11g) that you would like the AP detection to search on.

- Security:** Select the Security type **OFF**, **WEP**, **WPA-Enterprise**, **WPA-Personal**, **WPA2-Enterprise**, **WPA2-Personal**, **WPA-Auto-Enterprise**, and **WPA-Auto-Personal** that you would like to consider during AP detection.
- Rogue AP List:** This window shows all of the neighbor APs detected, which is based on your criteria from above (BSS Type, Band, and Security). If the AP is in the same network, or if you know the AP, just click on “**Add**” to save it to the AP list.
- AP List:** This window shows all of the APs that are allowed access on the network.

Home > Advanced Settings > DHCP Server > Dynamic Pool Settings

The screenshot shows the D-Link configuration interface for a DWL-3260AP. The left sidebar contains a tree view with categories: Basic Settings, Advanced Settings (Performance, Grouping, Multi-SSID, Rogue AP, DHCP Server, Dynamic Pool Setting, Static Pool Setting, Current IP Mapping L), Filters, and Status. The main content area is titled 'DHCP Dynamic Pools' and contains the following settings:

DHCP Server Control	
Function Enable/Disable	Disable
Dynamic Pool Settings	
IP Assigned From	0.0.0.0
The Range of Pool (1-255)	0
SubMask	0.0.0.0
Gateway	0.0.0.0
Wins	0.0.0.0
DNS	0.0.0.0
Domain Name	
Lease Time (60 - 31536000 sec)	0
Status	OFF

An 'Apply' button is located at the bottom right of the settings area.

DHCP Server Control: **Dynamic Host Configuration Protocol** assigns dynamic IP addresses to devices on the network. This protocol simplifies network management and allows new wireless devices to receive IP addresses automatically without the need to manually assign new IP addresses.

Select **Enable** to allow the DWL-3260AP to function as a DHCP server.

IP Assigned From: Input the first IP address available for assignment in your network.

The Range of Pool (1-255): Enter the number of IP addresses available for assignment.

SubMask: All devices in the network must have the same subnet mask to communicate. Enter the submask for the network here.

Gateway: Enter the IP address of the gateway on the network.

Wins: **Windows Internet Naming Service** is a system that determines the IP address of a network computer that has a dynamically assigned IP address.

DNS: Enter the IP address of the DNS server. The DNS (Domain Name Server) translates domain names such as www.dlink.com into IP addresses.

Domain Name: Enter the domain name of the DWL-3260AP, if applicable. (An example of a domain name is: www.dlink.com.)

Lease Time (60-31536000 sec.): The Lease Time is the period of time before the DHCP server will assign new IP addresses.

Status: Turn the **Dynamic Pool Settings ON** or **OFF** here.

Home > Advanced Settings > DHCP Server > Static Pool Settings

The screenshot shows the D-Link configuration interface for a DWL-3260AP. The left sidebar contains a tree view with categories: Basic Settings, Advanced Settings (Performance, Grouping, Multi-SSID, Rogue AP), DHCP Server (Dynamic Pool Setting, Static Pool Setting, Current IP Mapping L), Filters, and Status. The main content area is titled "DHCP Static Pools" and is divided into two sections: "DHCP Server Control" and "Static Pool Settings".

DHCP Server Control

Function Enable/Disable:

Static Pool Settings

Assigned IP:

Assigned MAC Address:

SubMask:

Gateway:

Wins:

DNS:

Domain Name:

Status:

MAC Address	IP address	State	Edit	Delete

DHCP Server Control: **Dynamic Host Configuration Protocol** assigns IP addresses to wireless devices on the network. This protocol simplifies network management and allows new wireless devices to receive IP addresses automatically without the need to manually assign IP addresses.

Select **Enable** to allow the DWL-3260AP to function as a DHCP server.

Assigned IP: Use the **Static Pool Settings** to assign the same IP address to a device at every restart. The IP addresses assigned in the Static Pool list must NOT be in the same IP range as the Dynamic Pool. After you have assigned a static IP address to a device via its MAC address, click **Apply**; the device will appear in the **Assigned Static Pool** at the bottom of the screen. Edit or delete the device in this list.

Assigned MAC Address: Enter the MAC address of the device here.

SubMask: Enter the subnet mask here.

- Gateway:** Enter the IP address of the gateway on the network.
- Wins:** **Windows Internet Naming Service** is a system that determines the IP address of a network computer with a dynamically assigned IP address, if applicable.
- DNS:** Enter the IP address of the Domain Name Server, if applicable. The DNS translates domain names such as www.dlink.com into IP addresses.
- Domain Name:** Enter the domain name of the DWL-3260AP, if applicable.
- Status:** This option turns the Static Pool settings ON or OFF.

Home > Advanced Settings > DHCP Server > Current IP Mapping List

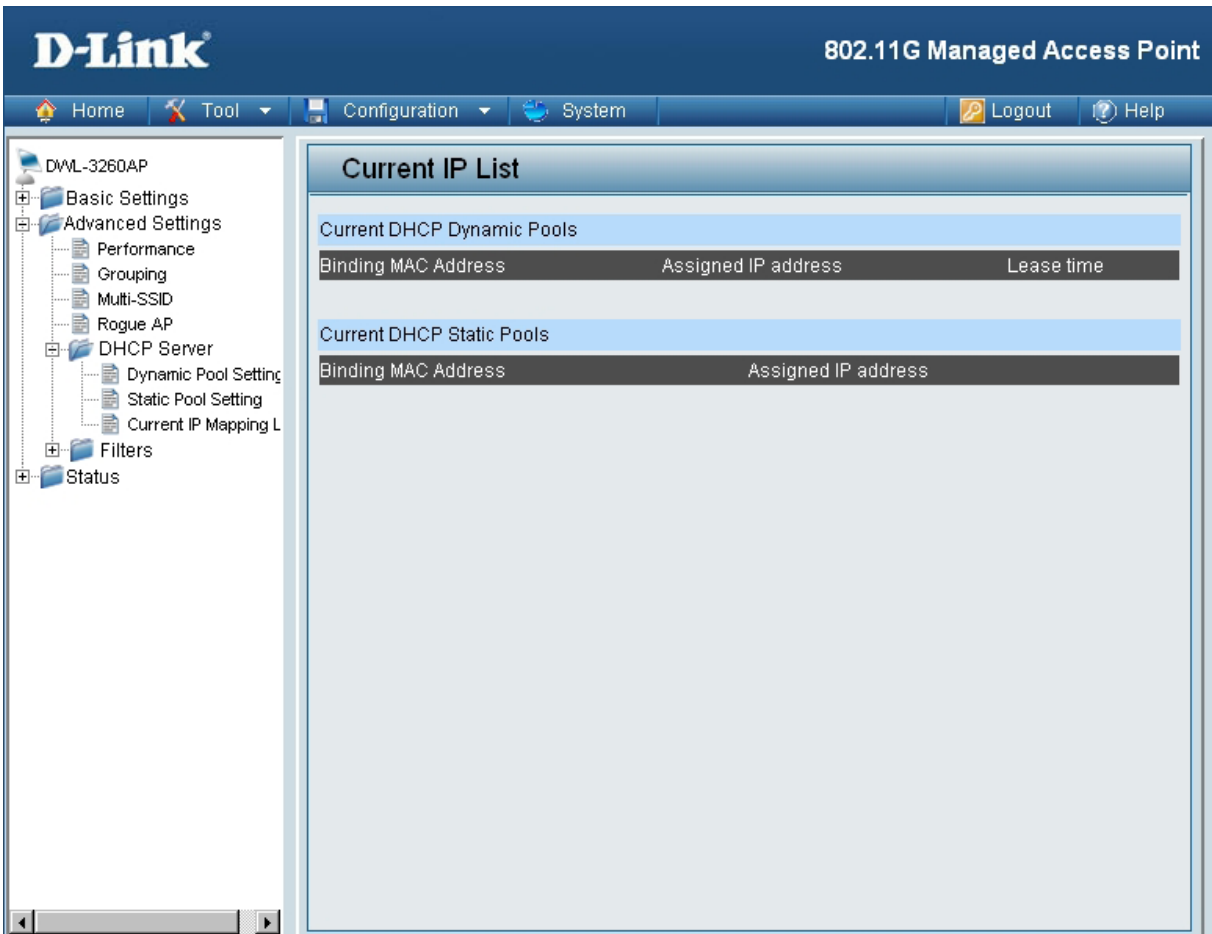

This screen displays information about the current DHCP dynamic and static IP address pools. This information is available when you enable the DHCP function of the DWL-3260AP and assign dynamic and static IP address pools.

Current DHCP Dynamic Pools:	These are IP address pools to which the DHCP server function has assigned dynamic IP addresses.
Binding MAC address:	The MAC address of a device on the network that is within the DHCP dynamic IP address pool.
Assigned IP address:	The current corresponding DHCP-assigned dynamic IP address of the device.
Lease Time:	The length of time that the dynamic IP address will be valid.
Current DHCP Static Pools:	These are IP address pools to which the DHCP server function has assigned static IP addresses.

Binding MAC address: The MAC address of a device on the network that is within the DHCP static IP address pool.

Assigned IP address: The current corresponding DHCP-assigned static IP address of the device.

Home > Advanced Settings > Filters > Wireless MAC ACL

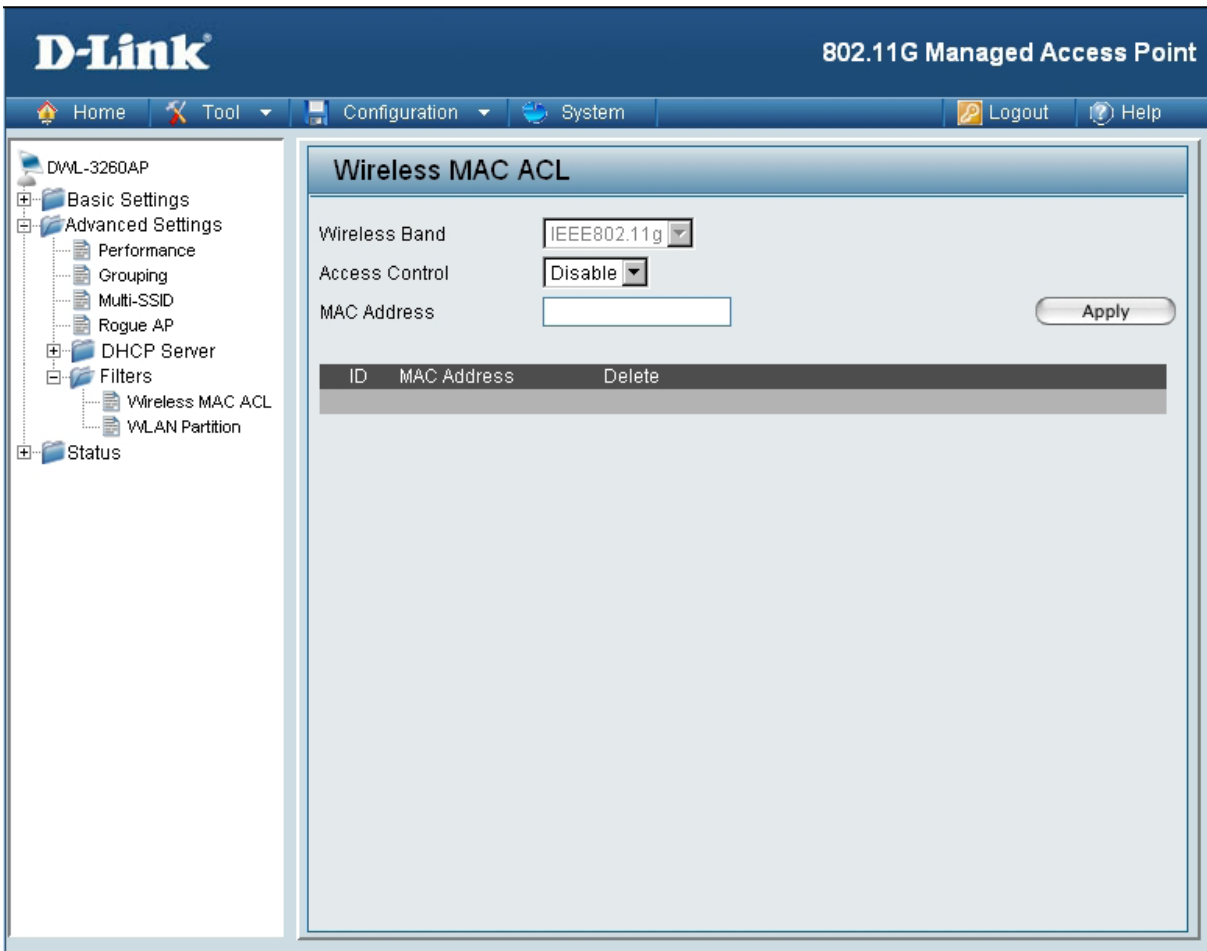

Wireless Band: IEEE 802.11g

Access Control: Select **Disabled** to disable the filters function.
 Select **Accept** to accept only those devices with MAC addresses in the Access Control List.
 Select **Reject** to reject the devices with MAC addresses in the Access Control List.

MAC Address: Enter the MAC addresses that you wish to include in your filters list, and click **Save**.

MAC Address List: When you enter a MAC address, it appears in this list. Highlight a MAC address and click **Delete** to remove it from the list.

Home > Advanced Settings > Filters > WLAN Partition

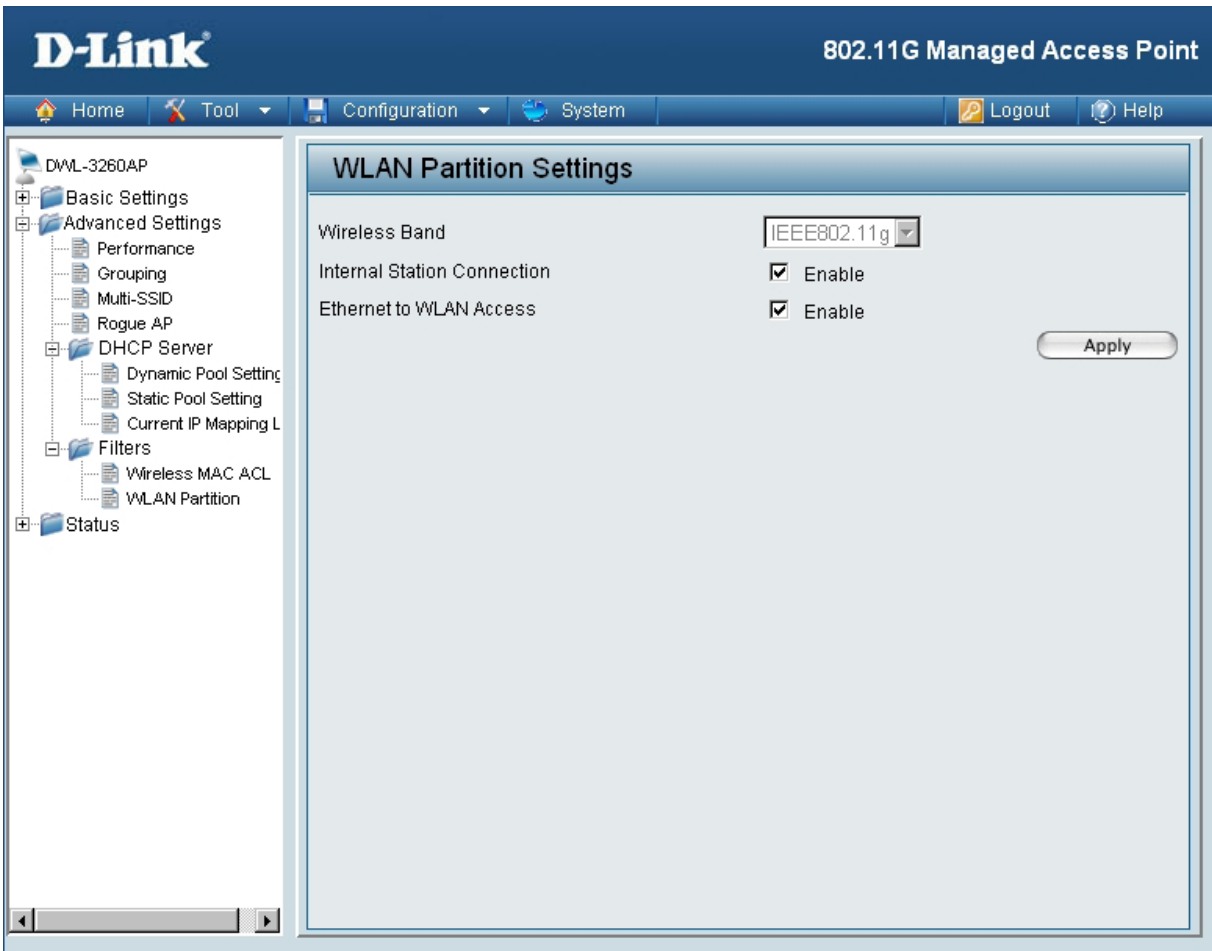

Wireless Band: IEEE 802.11g

Internal Station Connection: Enabling this feature allows wireless clients to communicate with each other. If this is disabled, wireless stations of the selected band are not allowed to exchange data through the access point.

Ethernet to WLAN Access: Enabling this feature allows Ethernet devices to communicate with wireless clients. If this is disabled, all data from the Ethernet to associated wireless devices is blocked. Wireless devices can still send data to the Ethernet.

Home > Status > Device Information

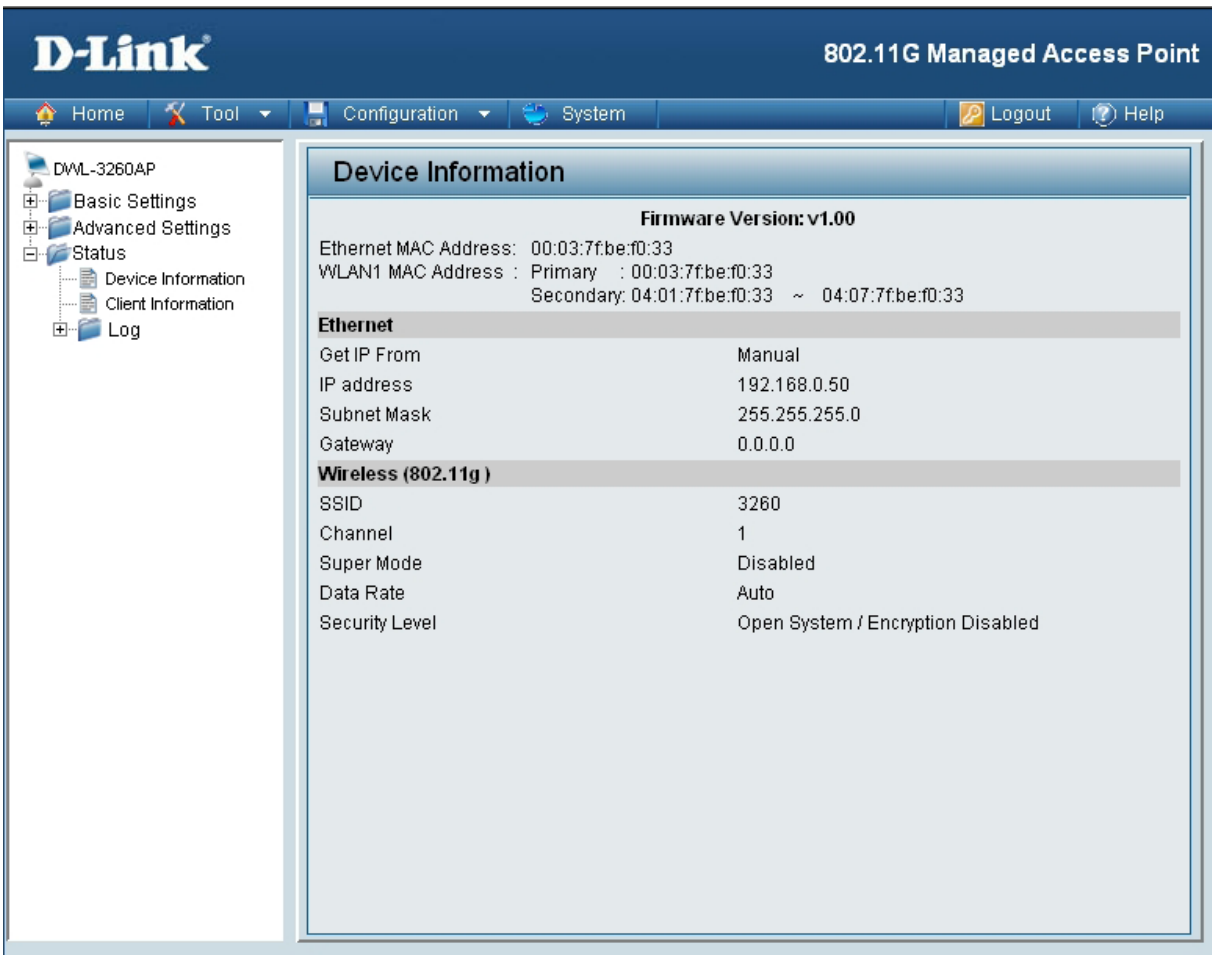

D-Link 802.11G Managed Access Point

Home Tool Configuration System Logout Help

DWL-3260AP

- Basic Settings
- Advanced Settings
- Status
 - Device Information
 - Client Information
- Log

Device Information

Firmware Version: v1.00

Ethernet MAC Address: 00:03:7f:be:f0:33
WLAN1 MAC Address : Primary : 00:03:7f:be:f0:33
Secondary: 04:01:7f:be:f0:33 ~ 04:07:7f:be:f0:33

Ethernet

Get IP From	Manual
IP address	192.168.0.50
Subnet Mask	255.255.255.0
Gateway	0.0.0.0

Wireless (802.11g)

SSID	3260
Channel	1
Super Mode	Disabled
Data Rate	Auto
Security Level	Open System / Encryption Disabled

Device Information: This window displays the configuration settings of the DWL-3260AP, including the firmware version and device MAC address.

Home > Status > Client Information

The screenshot shows the D-Link configuration interface for a DWL-3260AP. The main content area is titled 'Client Information' and displays 'Station association with 11B/G : 1'. Below this is a table with the following data:

SSID	MAC	Band	Authentication	Signal	Power Saving Mode
Primary-SSID	00:0e:35:76:43:cb	G	Open System	42%	Off

Client Information: This window displays the wireless client information for clients currently connected to the DWL-3260AP.

The following information is available for each client communicating with the DWL-3260AP.

MAC: Displays the MAC address of the client.

Band: Displays the wireless band the client is connected on.

Authentication: Displays the type of authentication being used.

Signal: Displays the strength of the clients signal.

Power Saving Mode: Displays the status of the power saving feature.

Home > Status > Log > View Log

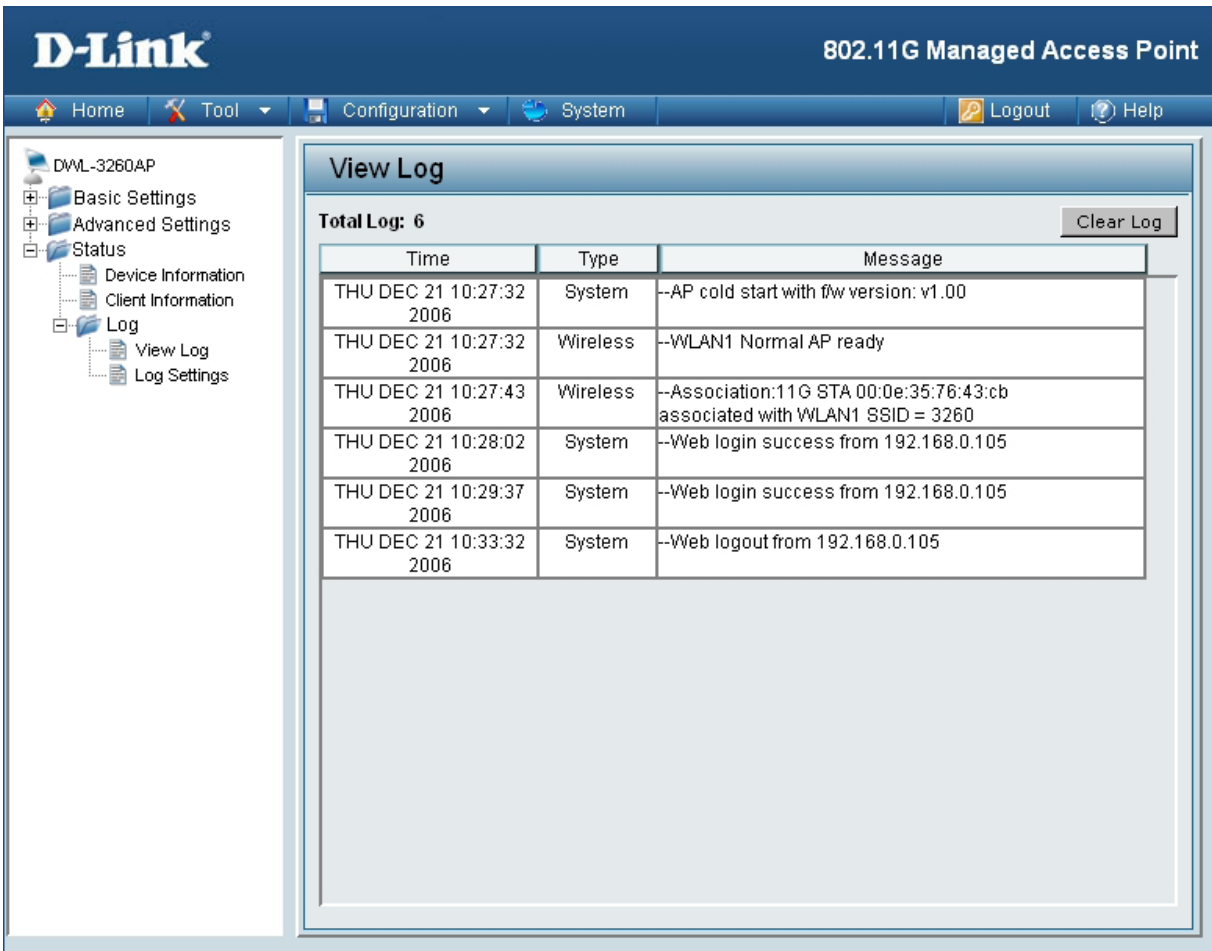

The screenshot shows the D-Link configuration interface for a DVL-3260AP. The navigation menu on the left includes Basic Settings, Advanced Settings, Status, Device Information, Client Information, Log, View Log, and Log Settings. The main content area is titled "View Log" and shows a table of log entries. The table has three columns: Time, Type, and Message. There are six log entries displayed, with a "Clear Log" button in the top right corner of the log area.

Time	Type	Message
THU DEC 21 10:27:32 2006	System	--AP cold start with fw version: v1.00
THU DEC 21 10:27:32 2006	Wireless	--WLAN1 Normal AP ready
THU DEC 21 10:27:43 2006	Wireless	--Association:11G STA 00:0e:35:76:43:cb associated with WLAN1 SSID = 3260
THU DEC 21 10:28:02 2006	System	--Web login success from 192.168.0.105
THU DEC 21 10:29:37 2006	System	--Web login success from 192.168.0.105
THU DEC 21 10:33:32 2006	System	--Web logout from 192.168.0.105

View Log: The log displays system and network messages including a time stamp and message type.

Home > Status > Log > Log Settings

D-Link 802.11G Managed Access Point

Home Tool Configuration System Logout Help

DWL-3260AP

- Basic Settings
- Advanced Settings
- Status
 - Device Information
 - Client Information
 - Log
 - View Log
 - Log Settings

System Log Settings

Log Settings

Log Server / IP address

Log Type

- System Activity
- Wireless Activity
- Notice

SMTP Settings

SMTP Enable

SMTP Server / IP address

SMTP Sender

SMTP Recipient

Apply

Log Settings

Log Server / IP Address: Enter the IP address of the server you would like to send the DWL-3260APs log to.

Log Type: Check the box for the type of activity you want to log. There are three types: **System**, **Wireless** and **Notice**.

SMTP Settings

SMTP: Check the box to enable SMTP.

SMTP Server / IP Address: Enter the IP address of the SMTP server.

SMTP Sender: Enter the e-mail address of the SMTP sender.

SMTP Recipient: Enter the e-mail address of the SMTP recipient.

Tool > Administrator Settings

The screenshot shows the 'Administrator Settings' configuration page for a DVL-3260AP device. The left sidebar contains a tree view with 'Basic Settings', 'Advanced Settings', and 'Status' expanded. The main content area is divided into several sections:

- Limit Administrator IP:** Contains a checkbox for 'Limit Administrator IP' and two text input fields for 'Limit Administrator IP 1' and 'Limit Administrator IP 2'.
- Login Settings:** Contains text input fields for 'User Name' (pre-filled with 'admin'), 'Old Password', 'New Password', and 'Confirm New Password'.
- Console Settings:** Contains a 'Status' checkbox (checked), 'Console Protocol' radio buttons for 'Telnet' (selected) and 'SSH', and a 'Timeout' dropdown menu set to '3 Mins'.
- SNMP Settings:** Contains a 'Status' checkbox (unchecked), and text input fields for 'Public Community String' (pre-filled with 'public') and 'Private Community String' (pre-filled with 'private').
- LED Status:** Contains a dropdown menu for 'External LED indicators' set to 'Enable'.

An 'Apply' button is located at the bottom right of the configuration area.

Limit Administrator IP

Check the box to enable the feature.

Limit Administrator IP 1:

Enter the IP address that the administrator will be allowed to log in from.

Limit Administrator IP 2:

Enter a secondary IP address that the administrator will be allowed to log in from.

Login Settings

User Name: Enter a user name. The default is admin.

Old Password: When changing your password, enter the old password here.

New Password: When changing your password, enter the new password here.

Confirm New Password: Confirm your new password here.

Console Settings

- Status:** Status is Enabled by default. Uncheck the box to disable the console.
- Console Protocol:** Select the type of protocol you would like to use, **Telnet** or **SSH**.

SNMP Settings

- Status:** Status is Enabled by default. Uncheck the box to disable the SNMP functions.
- Public Community String:** Enter the public SNMP community string.
- Private Community String:** Enter the private SNMP community string.

External LED Indicators

- Default:** The LED is ON by default. Uncheck the box to disable the LED indicator.
- Status:** When the LED is turned ON, there are two status: steady ON when link is ok, blinking when there is traffic.

Tool > Firmware and SSL Certification Upload

The screenshot shows the D-Link web interface for a DWL-3260AP. The top navigation bar includes 'Home', 'Tool', 'Configuration', 'System', 'Logout', and 'Help'. The left sidebar lists 'Basic Settings', 'Advanced Settings', and 'Status'. The main content area is titled 'Firmware and SSL Certification Upload' and contains two sections: 'Update Firmware From Local Hard Drive' and 'Update SSL Certification From Local Hard Drive'. The firmware section shows 'Firmware Version: v1.00' and a file upload field with 'Browse...' and 'Upload' buttons. The SSL section has two file upload fields, one for the certificate and one for the key, each with 'Browse...' and 'Upload' buttons.

Upload Firmware After downloading the most recent version of firmware for the DWL-3260AP from <http://support.dlink.com> to your local computer, use the **Browse** button to locate the firmware file on your computer. Click **Upload** to update the firmware version.

Upload SSL Certification: Click **Browse** to locate the SSL Certification file on your local computer. After selecting and opening the file, click **Upload** to upload the file to the DWL-3260AP.

Tool > Configuration File Upload and Download

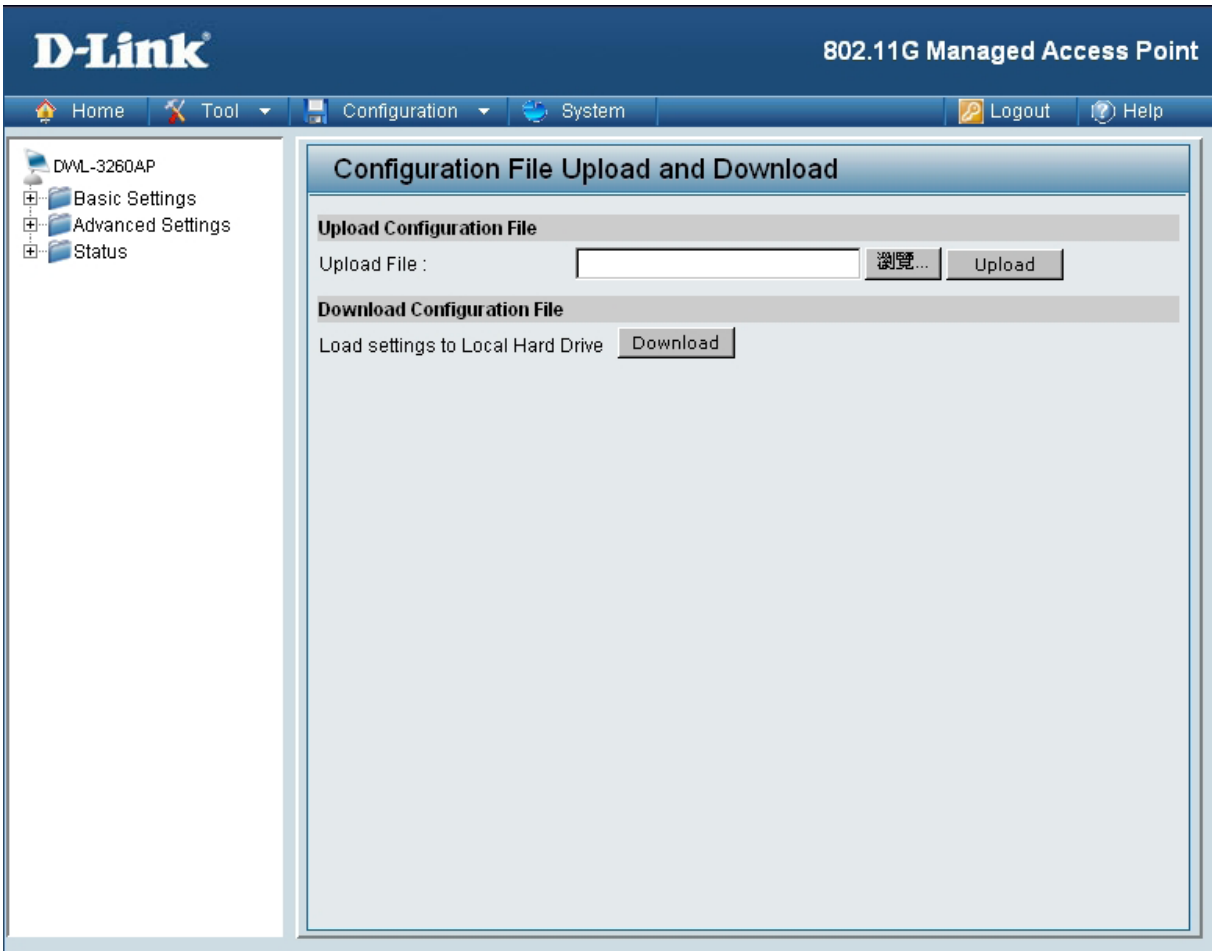

Upload File: Click **Browse** to locate a previously saved configuration file on your local computer. After selecting the file, click **Upload** to apply the configuration settings to the DWL-3260AP.

Download Configuration File: Click **Download** to save the current DWL-3260AP configuration to your local computer.

Tools > Cfg File > Choose file

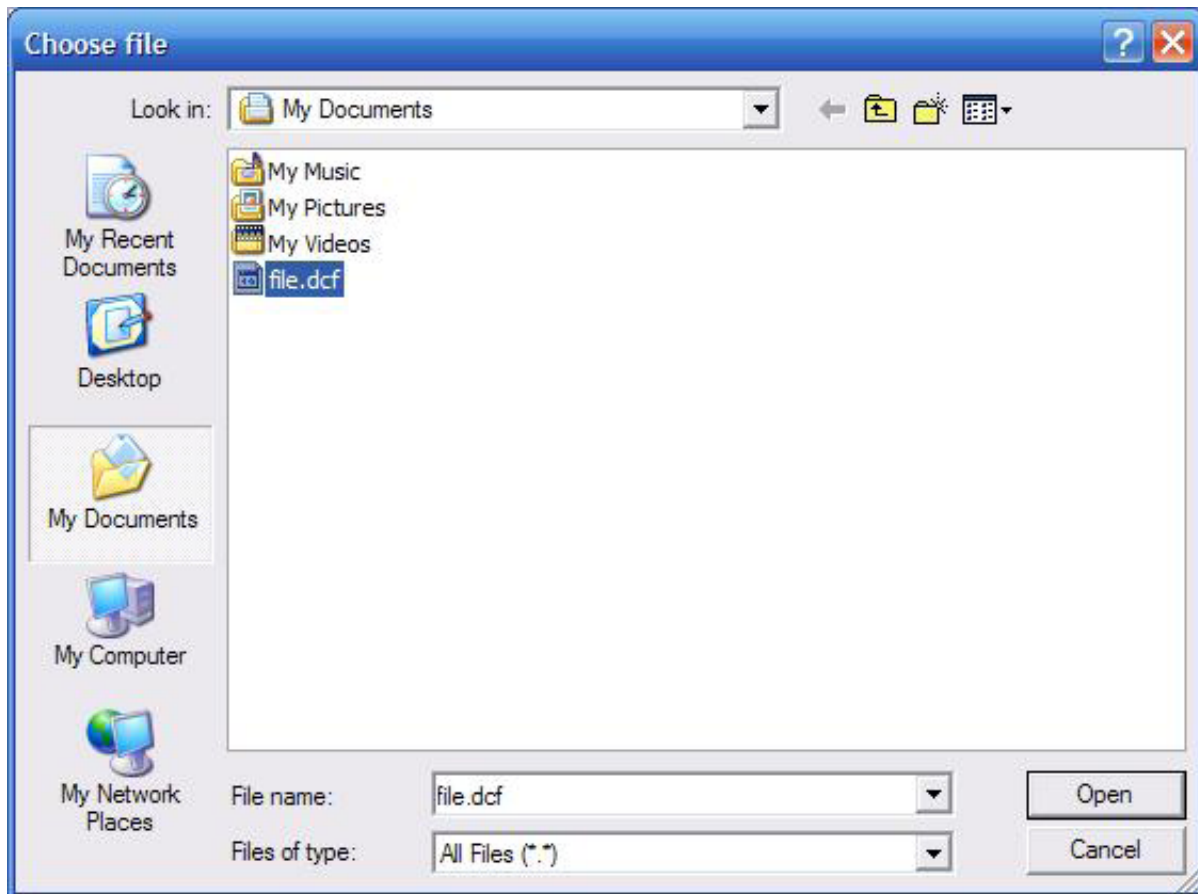

When you click **Browse** in the previous screen, the dialog box shown above appears.

Select the file you wish to download and click **Open**. Click **OK** to begin loading.

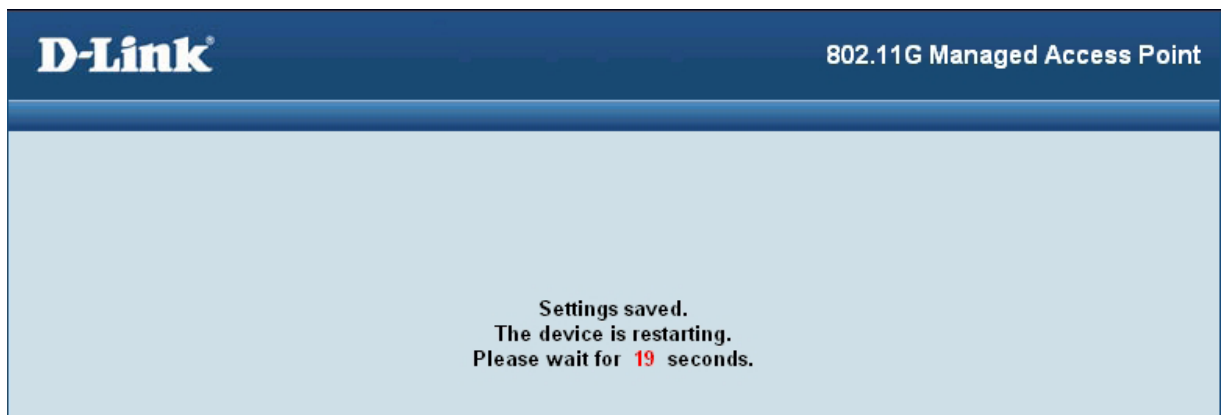

Click **Restart** for the settings to take effect. The dialog box above will appear as the device restarts. Please wait for a few seconds.

Tool > SNTP

D-Link 802.11G Managed Access Point

Home Tool Configuration System Logout Help

DWM-3260AP
Basic Settings
Advanced Settings
Status

SNTP Information / SNTP Settings

SNTP/NTP Information

SNTP/NTP Server IP

SNTP/NTP Time Zone (GMT) Greenwich Mean Time : Dublin, Edinburgh, Lisbon, London

Local Time

SNTP/NTP Setting

SNTP/NTP Server IP

SNTP/NTP Time Zone (GMT) Greenwich Mean Time : Dublin, Edinburgh, Lisbon, London

Daylight Saving Time Enable

Apply

SNTP/NTP Information: Displays the current SNTP/NTP settings.

SNTP/NTP Server IP Address: Enter the SNTP/NTP server IP address.

SNTP/NTP Time Zone: Select your correct Time Zone.

Daylight Saving Time: Check the box to **Enable** Daylight Saving Time.

System > System Settings

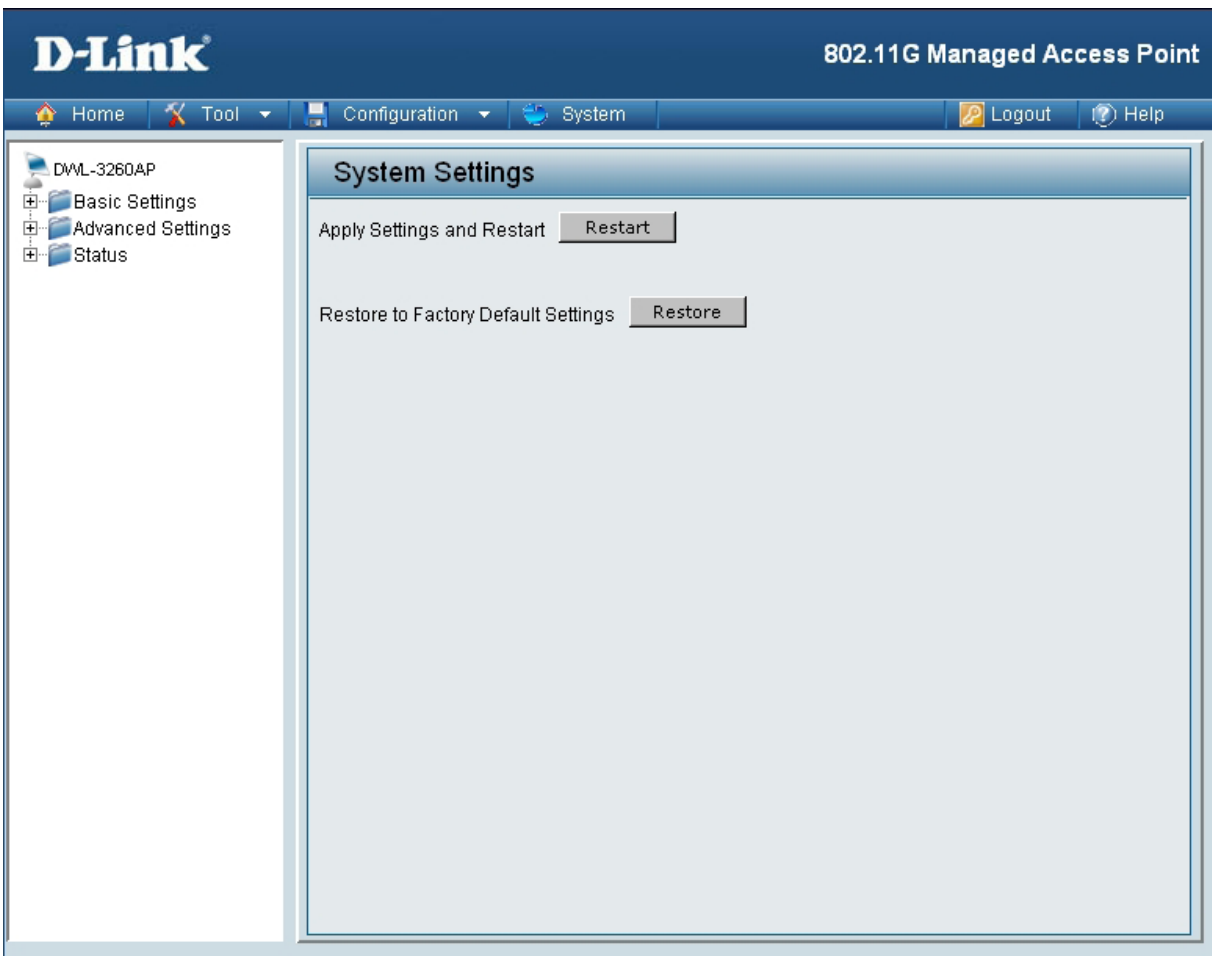

Click **Restart** to restart the DWL-3260AP.

Click **Restore** to restore the DWL-3260AP back to factory default settings.

Help

Home

Advanced Settings

Performance

You can customize the network radio to fit your needs by tuning radio parameters in performance section. Performance functions are designed for advanced users who are familiar with 802.11 wireless networks and radio configuration.

Wireless Band

IEEE 802.11g is supported.

Frequency

The operation frequency display will change according to the channel selected.

Channel

By default, the AP is set to Auto Channel Scan. The channel can be changed to fit the channel setting for an existing wireless network or to customize the wireless network.

Data Rate

Indicate the base transfer rates based on the speed of wireless adapters on the wireless local area network (WLAN). The default value is set to "Auto" which adjusts the base transfer rate depending on the base rate of the connecting device.

Beacon Interval (20-1000)

Beacons are packets sent by an access point to synchronize a wireless network. Specify a Beacon interval value between 20 and 1000. The default value is set to 100 milliseconds.

DTIM (1-255)

DTIM Interval specifies the number of AP beacons between each Delivery Traffic Indication Message (DTIM). It informs associated stations of the next window for listening to broadcast and multicast messages. You can specify a DTIM value range from 1 to 255. The AP will send the next DTIM with specified DTIM value to stations if there is any buffered broadcast or multicast message. Stations hear the beacons and get ready to receive the broadcast or multicast messages. The default value for DTIM interval is 1.

Fragment Length (256-2346)

The default value is 2346 for fragmentation. By fragmenting packets into shorter fragments, the time spent on re-transmissions can be reduced if the packet error rate is high. However, unnecessary short fragment length will result in poor performance due to low transmission efficiency.

RTS Interval (1-2346)

The default value for request to send (RTS) threshold is 2346. With smaller RTS length value, the wireless network can recover from interference and collisions quicker since more RTS packets are transmitted. However, more RTS packets also consume more bandwidth, which leads to low throughput. Thus, small RTS Length value is only recommended for heavy loading network or high electromagnetic wireless interference.

Help: | Scroll down the Help page for topics and explanations.

Using the AP Manager

The **AP Manager** is a convenient tool to manage the configuration of your network from a central computer. With **AP Manager** there is no need to configure devices individually.

To launch the AP Manager:

- Go to the Start Menu
- Select Programs
- Select D-Link **AirPremier** AP Manager
- Select DWL-3260AP



Discovering Devices



Click on this button to discover the devices available on the network.

D-Link 802.11G Managed Access Point

Exist	Model Name	MAC Address	IP Address	Netmask	F/W Version	Device Name	Action	Status
✓	DWL-3260AP	00037FBEF033	192.168.0.50	255.255.25...	v1.00	D-Link Acce...		

Discover the devices

Discovering devices...

Action Message

Selecting Devices

The AP Manager allows you to configure multiple devices all at once. To select a single device, simply click on the device you want to select. To select multiple devices, hold down the **Ctrl** key while clicking on each additional device. To select an entire list, hold the **Shift** key, click on the first AP on the list and then click on the last AP on the list.

IP Configuration



You can assign an IP address to an AP or assign IP addresses to multiple AP's by clicking on this button after selecting the device(s).

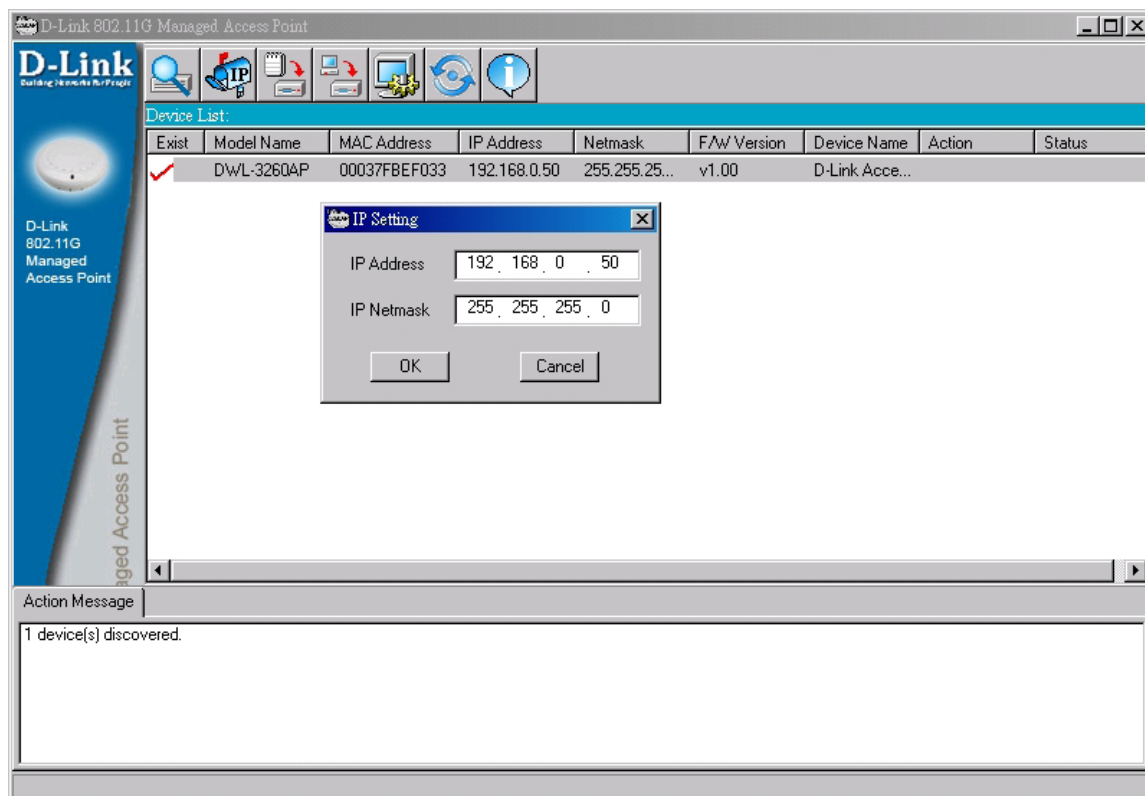

Select the AP that you want to assign an IP address to and click the IP button. Enter the IP address and IP netmask for the selected device and click OK.

You can configure multiple AP's with IP addresses all at once. Click on the IP button after you've selected all of the AP's you want to assign an IP address. Enter the IP address you want to assign the first unit and the AP manager will automatically assign sequential IP addresses.

Device Configuration



Click on this button to access the configuration properties of the selected device(s).

The device configuration window allows you to configure settings but does not actually apply the settings to the device unless you click the **Apply** button. You can also save and load configuration files from this window. When you load a configuration file, you must click **Apply** if you want the settings to be applied to the selected device(s).

You can configure a single device by highlighting one device in the list, or you can configure multiple devices by highlighting multiple devices before clicking on the Device Configuration icon pictured above. The examples in this section show single device configuration. When you select multiple devices for configuration the procedure will be similar.

Check All

The Check All button will select all configurable options. Any setting that has a check mark next to it is applied to the device or saved to the configuration file.

Clear Checks

The Clear Checks button deselects all configurable options. This feature is useful if you only want to change a few settings. Deselect all items and only check the items that you want to modify.

Refresh

Refresh will revert to the actual device settings of the selected device(s).

Apply

To save settings to the device, you must click the Apply button. Only settings that have a check mark next to them will be applied.

Open

The open button is used to load a previously saved configuration file. After opening a configuration file, you must click the Apply button to save the settings to the selected device(s).

Save

The save button allows you to save a configuration file of the selected device settings. Only settings that have a check mark next to them are saved. You cannot save a configuration file if you selected more than one device in the device list.

Exit

The Exit button will close the device configuration window. Any settings that haven't been applied will be lost.



Device Configuration

General | Wireless | Security | Filter | AP Mode | DHCP Server | Client Info | Rogue AP | Log

Device Name: D-Link Access Point

LAN

IP Address: 192 . 168 . 0 . 50 Gateway: 0 . 0 . 0 . 0

Subnet Mask: 255 . 255 . 255 . 0 DHCP Client: Disable

Grouping

Load Balance: Disable Link Integrity: Disable

User Limit (0-64): 10 Ethernet Link Status: Link-Down

Check All | Clear Checks | Refresh | Apply | Open | Save | Exit

Device Configuration > General

When selecting multiple devices for configuration, some options are unavailable for configuration by default as noted(*) below:

- Device Name(*):** This allows you to change the device name for the selected access point. You must place a check mark in the Device Name box to change the name. This option should only be configured when one access point is selected for configuration.
- IP address and Subnet Mask(*):** If you've selected one device for configuration and you want to change the IP address of the device, check the IP Address box. You can then enter an IP address and Subnet Mask for the selected access point. This option should only be configurable when one access point is selected for configuration. To configure multiple devices with an IP address at one time, please reference the previous page.
- Gateway:** Enter the IP address of your gateway, typically your router address.

Device Configuration > General (continued)

DHCP client:	There is a pull-down menu to select enabled or disabled. When enabled, the selected device(s) will function as a DHCP client(s). This allows them to receive IP configuration information from a DHCP server. When disabled, the access point(s) must have a static IP address assigned to them.
Telnet Support:	This pull-down selection enables or disables the ability to Telnet into the selected device(s).
Telnet Timeout:	This pull-down selection defines the timeout period during a Telnet session with the selected device(s).
Console Protocol:	Select either Telnet or SSH from the pull-down.
Status:	Click Enabled to support SNMP. SNMP is disabled by default.
Public Community String:	When SNMP is enabled, you can change the Public Community Name here.
Private Community String:	When SNMP is enabled, you can change the Private Community Name here.

Device Configuration > Wireless

Device Configuration

General | **Wireless** | Security | Filter | AP Mode | DHCP Server | Client Info | Rogue AP | Log

IEEE802.11g

Wireless Setting

Wireless Network Name (SSID) dlink Data Rate Auto

Channel 1 Beacon Interval (20~1000) 100

SSID Broadcast Enable DTIM (1~255) 1

Super G Disable Fragment Length (256~2346) 2346

Radio On RTS Length (256~2346) 2346

Preamble Short and Long Tx Power Full

Wireless B/G Mode Mixed Auto Channel Scan Disable

WMM Enable

Check All Clear Checks Refresh Apply Open Save Exit

Wireless: Check to enable wireless mode.

SSID: The Service Set (network) Identifier of your wireless network.

Channel: Allows you to select a channel. 6 is the default setting (see Auto Channel Scan on the next page).

SSID Broadcast: Allows you to enable or disable the broadcasting of the SSID to network clients.

Super G: Select this option to enable a wireless signal rate of up to

Radio Wave: Select **On** or **Off**.

Preamble: Select the default value **Short and Long**, or **Long Only**.

Wireless B/G Mode: Select **Mixed**, **11G Only**, or **11B Only**.

WMM: Select **Enable** or **Disable**, **Disable** is selected by default. WMM stands for Wi-Fi Multimedia, by enabling this feature it will improve the user experience for audio and video applications over a Wi-Fi network.

Device Configuration > Wireless

Date Rate:	A pull-down menu to select the maximum wireless signal rate for the selected device(s).
Beacon Interval (20~1000):	Beacons are packets sent by an access point to synchronize a network. Specify the beacon value for the selected device(s) here. The default value of 100 is recommended.
DTIM (1~255):	DTIM (Delivery Traffic Indication Message) is a countdown informing clients of the next listening window for broadcast and multicast messages.
Fragment Length (256~2346):	This sets the fragmentation threshold (specified in bytes). Packets exceeding the value set here will be fragmented. The default is
RTS Length (256~2346):	The RTS value should not be changed unless you encounter inconsistent data flow. The default value is 2346.
Tx Power:	A pull-down menu for selecting the transmit power of the selected device(s).
Auto Channel Scan:	Select this option to automatically select the most optimal channel available for wireless networking (default for AP mode).
Antenna Diversity:	<p>The DWL-3260AP supports 2.4GHz radio with two antennas. Radio is connected to each antenna and supports auto diversity mode by default. This means that the access point will auto switch to the antenna with better RSSI value.</p> <p>Diversity: The DWL-3260AP will auto switch to the antenna with better RSSI value.</p> <p>Left Antenna: The AP will not switch antenna and the radio will use the left antenna (when facing the AP) to transmit and receive packets.</p> <p>Right Antenna: AP won't switch antenna and the radio will use the right antenna (when facing the AP) to transmit and receive packets.</p>

*Maximum wireless signal rate derived from IEEE Standard 802.11g specifications. Actual data throughput will vary. Network conditions and environmental factors, including volume of network traffic, building materials and construction, and network overhead, lower actual data throughput rate. Environmental factors may adversely affect wireless signal range.

Device Configuration > Security > Authentication

The screenshot shows the 'Device Configuration' window with the 'Security' tab selected. The 'WEP Key' section is active, showing settings for IEEE802.11g. The 'Authentication' checkbox is checked and set to 'Open'. The 'Encryption' is set to 'Disable'. The 'Active Key Index' is set to '1'. There are four key entries, each with a '64' key length, 'HEX' encoding, and a masked key value.

Key Index	Length	Encoding	Key Value
1st Key	64	HEX	XXXXXXXXXXXXXXXXXXXXXXXXXXXXXXXX
2nd Key	64	HEX	XXXXXXXXXXXXXXXXXXXXXXXXXXXXXXXX
3rd Key	64	HEX	XXXXXXXXXXXXXXXXXXXXXXXXXXXXXXXX
4th Key	64	HEX	XXXXXXXXXXXXXXXXXXXXXXXXXXXXXXXX

Buttons at the bottom: Check All, Clear Checks, Refresh, Apply, Open, Save, Exit.

Device Configuration > Security > Authentication (continued)

AP Mode	Authentication Available
Access Point	Open System Shared Key Open System/Shared Key WPA-Enterprise WPA-Personal WPA2-Enterprise WPA2-Personal WPA-Auto-Enterprise WPA-Auto-Personal
WDS with AP	Open System Shared Key Open System/Shared Key WPA-Personal WPA2-Personal WPA-Auto-Personal
WDS	Open System Shared Key Open System/Shared Key WPA-Personal WPA2-Personal WPA-Auto-Personal

Select **Open System** to communicate the key across the network.

Select **Shared Key** to limit communication to only those devices that share the same WEP settings.

Select **Open System/Shared Key** to allow either form of data encryption.

Select **WPA-Enterprise**, **WPA2-Enterprise**, or **WPA-Auto-Enterprise** to secure your network with the inclusion of a RADIUS server.

Select **WPA-Personal**, **WPA2-Personal**, or **WPA-Auto-Personal** to secure your network using a password and dynamic key changes.

(No RADIUS Server required).

Device Configuration > Security > Open and Shared

The screenshot shows the 'Security' tab for IEEE802.11g. The 'WEP Key' section is active. The 'Authentication' dropdown is set to 'Open'. The 'Encryption' dropdown is set to 'Disable'. The 'Active Key Index' is set to '1'. There are four key entries, each with a '64' bit size, 'HEX' type, and a masked key value (XXXXXXXXXX).

The Security tab contains the WEP configuration settings on the initial page. If you select WPA as the authentication type, an additional tab will appear with the WPA configuration options based on your selection.

Authentication Type:	Select from the pull-down menu the type of authentication to be used on the selected device(s).
Encryption:	Enable or disable encryption on the selected device(s).
Active Key Index:	Select which defined key is active on the selected device(s).
Key Values:	Select the key size (64-bit, 128-bit, or 152-bit) and key type (HEX or ASCII) and then enter a string to use as the key. The key length is automatically adjusted based on the settings you choose.

Device Configuration > Security > WPA-Enterprise, WPA2-Enterprise, & WPA-Auto-Enterprise

The screenshot shows the 'Device Configuration' window with the 'Security' tab selected. The 'WEP Key' is 'IEEE802.11g/WPA'. The 'WPA setting' checkbox is checked. Under 'WPA setting', 'Cipher Type' is set to 'Auto', 'Group Key Update Interval' is '1800' (range 300-9999999), and 'PassPhrase' is empty (range 8-63 chars). Under 'Security Server', 'RADIUS Server' is '0.0.0.0', 'RADIUS Port (1 - 65535)' is '1812', 'RADIUS Secret' is empty, 'Accounting Mode' is 'Disable', 'Accounting Server' is '0.0.0.0', and 'Accounting Port' is '1813'. At the bottom are buttons for 'Check All', 'Clear Checks', 'Refresh', 'Apply', 'Open', 'Save', and 'Exit'.

Cipher Type: Select **Auto**, **AES**, or **TKIP** from the pull-down menu.

Group Key Update Interval: Select the interval during which the group key will be valid. 1800 is the recommended setting. A lower interval may reduce transfer

RADIUS Server: Enter the IP address of the RADIUS server.

RADIUS Port: Enter the port used on the RADIUS server (1812 is default).

RADIUS Secret: Enter the RADIUS secret.

Accounting Mode: Select if you want to use a different server for accounting.

Accounting Server: Enter the IP address of the Accounting server.

Accounting Port: Enter the Accounting port (1813 is default).

Device Configuration > Security > WPA-Personal, WPA2-Personal, & WPA-Auto-Personal

The screenshot shows the 'Device Configuration' window with the 'Security' tab selected. The 'WEP Key' is set to 'IEEE802.11g/WPA'. A checkbox for 'WPA setting' is checked. Below this, there are three fields: 'Cipher Type' with a dropdown menu set to 'Auto', 'Group Key Update Interval' with a text box containing '1800' and a range '(300 - 9999999)', and 'PassPhrase' with an empty text box and a range '(8 - 63 chars)'. At the bottom of the window are buttons for 'Check All', 'Clear Checks', 'Refresh', 'Apply', 'Open', 'Save', and 'Exit'.

Cipher Type: Select **Auto**, **AES**, or **TKIP** from the pull-down menu.

Group Key Update Interval: Select the interval during which the group key will be valid. 1800 is the recommended setting. A lower interval may reduce transfer

PassPhrase: Enter a PassPhrase between 8-63 characters in length.

Device Configuration > Filters

The screenshot shows the 'Device Configuration' window with the 'Filter' tab selected. The 'WLAN Partition' section is set to 'IEEE802.11g'. Under this partition, 'Internal Station Connection' and 'Ethernet to WLAN Access' are both checked and set to 'Enable'. The 'IEEE802.11g Access Setting' section has 'Access Control' checked and set to 'Accept'. Below this, there is an 'ACL MAC Address' field with the value '00:00:00:00:00:0' and 'Add' and 'Del' buttons. At the bottom of the window are buttons for 'Check All', 'Clear Checks', 'Refresh', 'Apply', 'Open', 'Save', and 'Exit'.

Internal Station Connection: Enabling this allows wireless clients to communicate with each other. When this option is disabled, wireless stations are not allowed to exchange data through the access point.

Ethernet to WLAN Access: Enabling this option allows Ethernet devices to communicate with wireless clients. When this option is disabled, all data from Ethernet to wireless clients is blocked. Wireless devices can still send data to the Ethernet devices when this is disabled.

Access Control: When disabled access control is not filtered based on the MAC address. If **Accept** or **Reject** is selected, then a box appears for entering MAC addresses. When **Accept** is selected, only devices with a MAC address in the list are granted access. When **Reject** is selected, devices in the list of MAC addresses are not granted access.

Access Control List: **Add** or **Delete** MAC addresses in the Access Control List.

Device Configuration > AP Mode

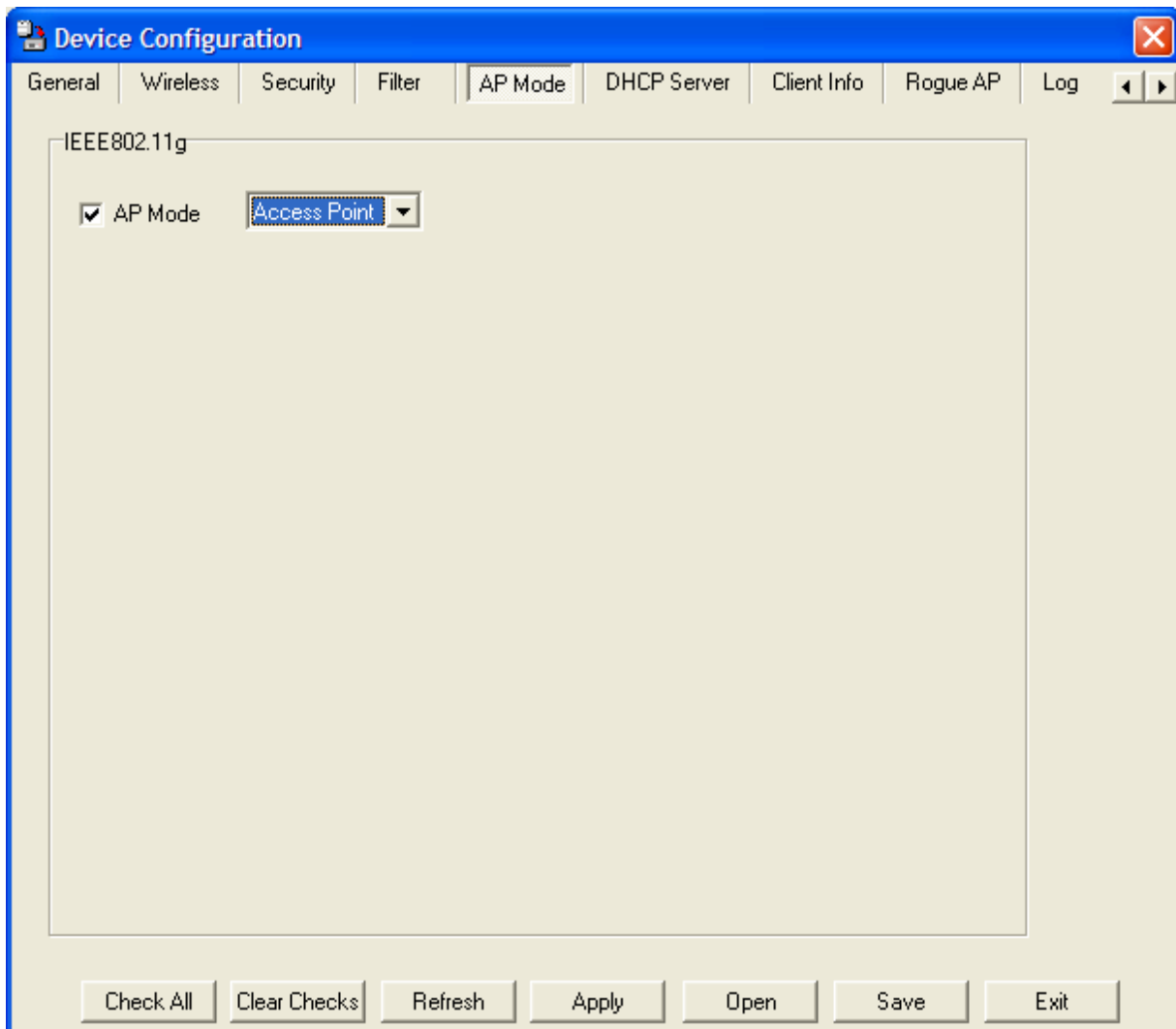

Access Point: There are 3 AP modes:

Access Point
WDS with AP
WDS

Please see the following pages for an explanation of the other 2 AP modes.

Device Configuration > AP Mode > WDS with AP

Device Configuration

General | Wireless | Security | Filter | **AP Mode** | DHCP Server | Client Info | Rogue AP | Log

IEEE802.11g

AP Mode **WDS with AP**

Remote AP MAC Address

00:00:00:00:00:00 Add Del

Site Survey

SSID	BSSID
------	-------

Site Survey

Check All Clear Checks Refresh Apply Open Save Exit

WDS with AP: Allows you to connect multiple wireless LANs together, while still functioning as an AP. If enabled, you may either enter the MAC address of the other DWL-3260APs or click Site Survey and add APs from there.

Device Configuration > WDS

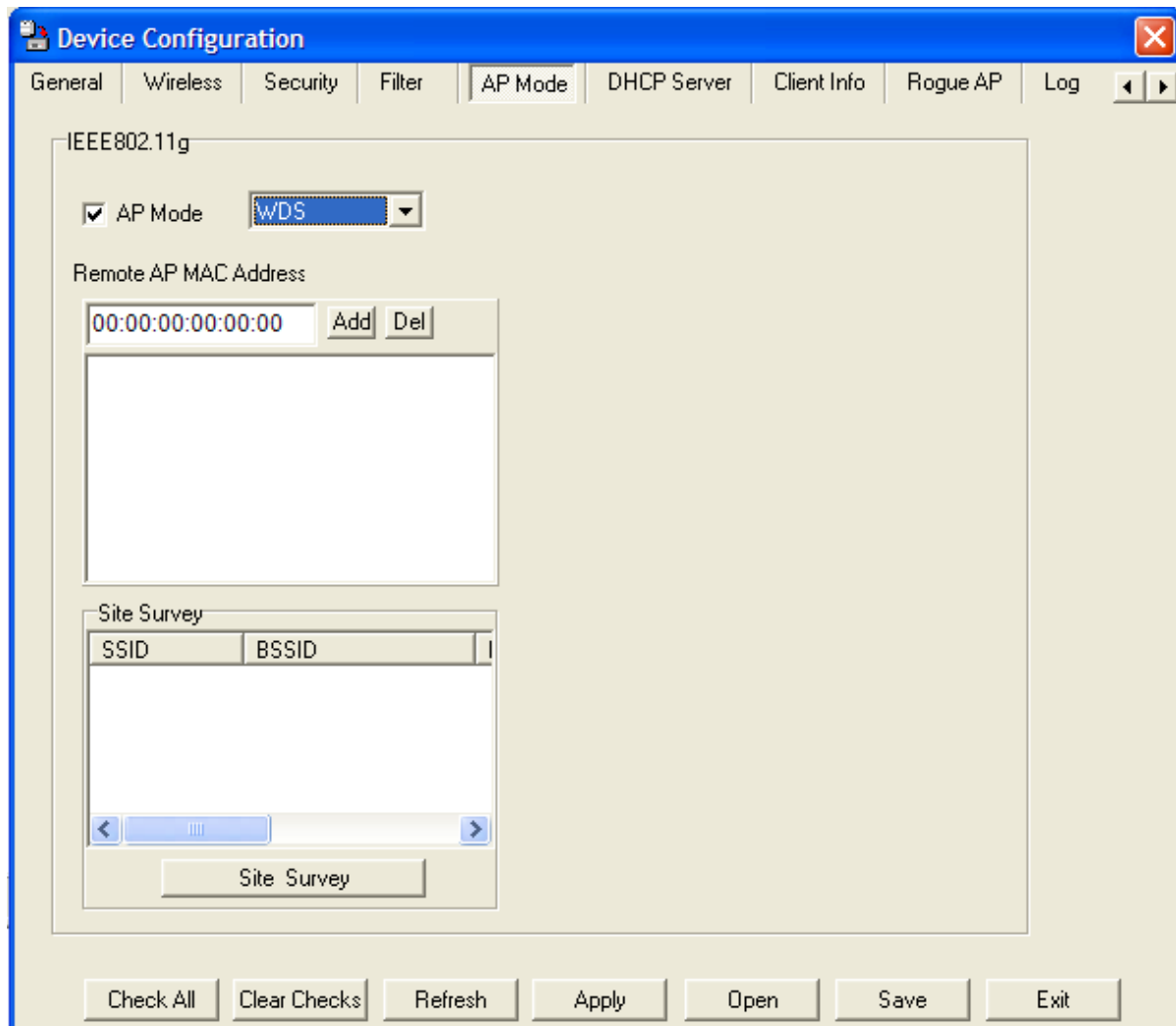

WDS: Allows you to connect multiple wireless LANs together. All other LANs must be using DWL-3260APs. When enabled, you may either enter the MAC address of the other DWL-3260APs or click Site Survey and add APs from there.

Device Configuration > DHCP Server

Device Configuration

General | Wireless | Security | Filter | AP Mode | **DHCP Server** | Client Info | Rogue AP | Log

DHCP Server | Disable

Dynamic Pool Settings

Static Pool Settings

IP Assigned From: 0 . 0 . 0 . 0

Range of Pool (1~255) 0

SubMask 0 . 0 . 0 . 0

Gateway 0 . 0 . 0 . 0

Wins 0 . 0 . 0 . 0

DNS 0 . 0 . 0 . 0

Domain Name

Lease Time(60~31536000 sec) 0

Status OFF

Add Edit Del

MAC Address	IP Address	Status
-------------	------------	--------

Check All Clear Checks Refresh Apply Open Save Exit

DHCP Server: Enable or disable the DHCP server function.

Dynamic Pool Settings: Click to enable Dynamic Pool Settings. Configure the IP address pool in the fields below.

Static Pool Settings: Click to enable Static Pool Settings. Use this function to assign the same IP address to a device at every restart. The IP addresses assigned in the Static Pool list must NOT be in the same IP range as the Dynamic Pool.

IP Assigned From: Enter the initial IP address to be assigned by the DHCP server.

Range of Pool (1~255): Enter the number of allocated IP addresses.

Device Configuration > DHCP Server (continued)

SubMask:	Enter the subnet mask.
Gateway:	Enter the gateway IP address, typically a router.
Wins:	Wins (Windows Internet Naming Service) is a system that determines the IP address of a network computer with a dynamically assigned IP address, if applicable.
DNS:	The IP address of the DNS server, if applicable.
Domain Name:	Enter the domain name of the DWL-3260AP, if applicable.
Lease Time:	The period of time that the client will retain the assigned IP address.
Status:	This option turns the dynamic pool settings on or off.

Device Configuration > Client Info

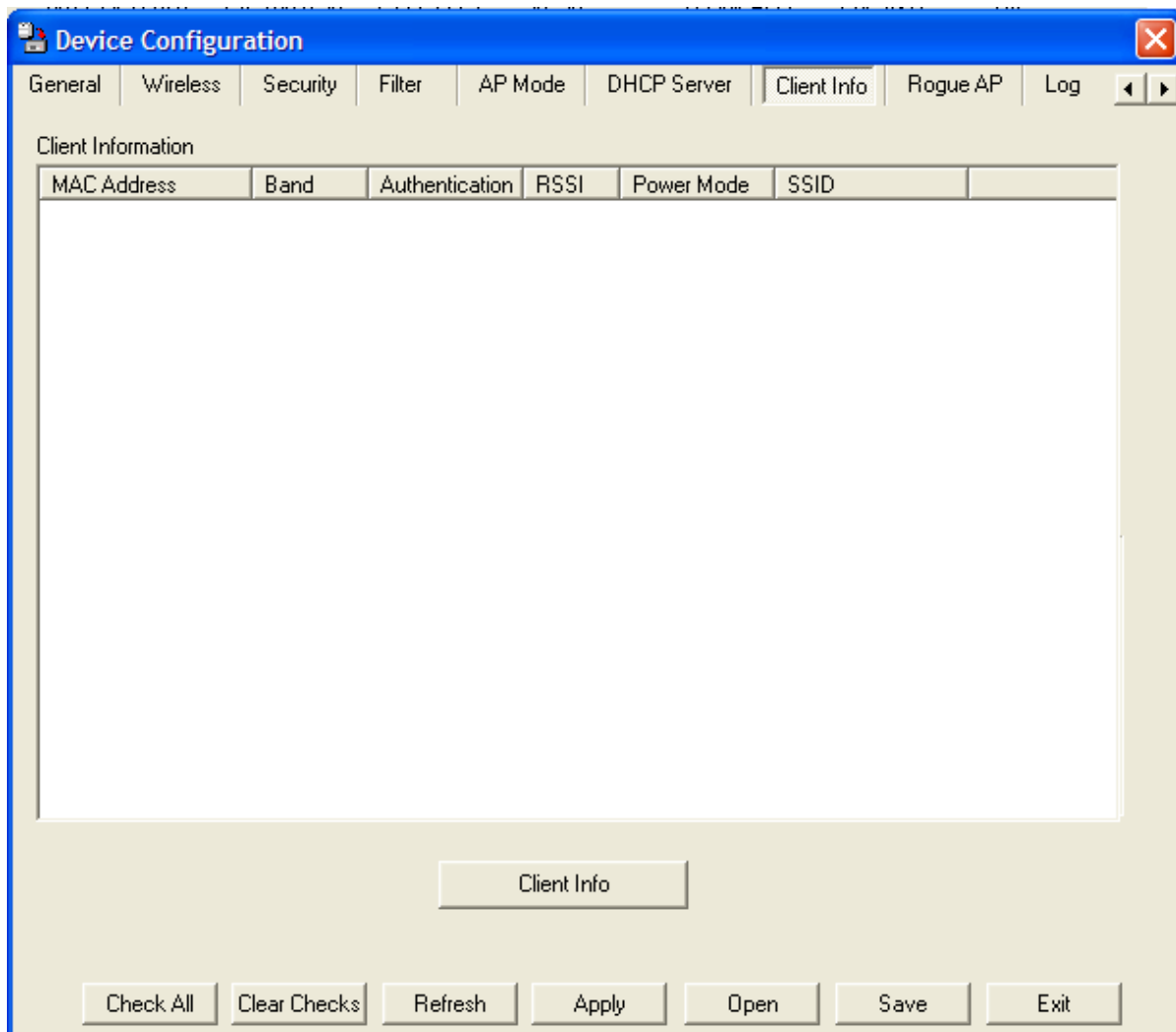

Client Information: Information on wireless clients will be shown here. A client is a device on the network that is communicating with the DWL-3260AP with a wireless connection.

MAC Address: Displays the MAC address of the client.

Band: Displays the wireless band.

Authentication: Displays the type of authentication that is enabled.

RSSI: Indicates the strength of the signal.

Power Mode: Displays the status of the power saving feature.

SSID: Displays the SSID.

Device Configuration > Rogue AP

The screenshot shows the 'Device Configuration' window with the 'Rogue AP' tab selected. The 'Rogue AP Detection' section contains the following options:

- BSS Type:** AP BSS, Ad Hoc, Both
- Band:** 11b, 11g
- Security:** OFF, WEP, WPA-Enterprise, WPA-Personal, WPA2-Enterprise, WPA2-Personal, WPA-Auto-Enterprise, WPA-Auto-Personal

Below these are two lists: 'Rogue AP List' and 'AP List', each with columns for 'SSID' and 'BSSID'. A '>' button is between the lists, and a 'Del' button is below it. A 'Detect' button is at the bottom left of the lists. At the bottom of the window are buttons for 'Check All', 'Clear Checks', 'Refresh', 'Apply', 'Open', 'Save', and 'Exit'.

BSS Type: The Basic Service Set Type allows you to select from **AP BSS**, **Ad Hoc**, or **Both**.

Band: Select the type of network (bands 11b and 11g) that you would like the AP detection to search on.

Security: Select the Security type **OFF**, **WEP**, **WPA-Enterprise**, **WPA-Personal**, **WPA2-Enterprise**, **WPA2-Personal**, **WPA-Auto-Enterprise**, and **WPA-Auto-Personal** that you would like to consider during AP detection.

Rogue AP List: This window shows all of the neighbor APs detected, which is based on your criteria from above (BSS Type, Band, and Security). If the AP is in the same network, or if you know the AP, just click on ">" to save it to the AP list.

AP List: This window shows all of the APs that are allowed access on the network.

Device Configuration > Log

Device Configuration

General | Wireless | Security | Filter | AP Mode | DHCP Server | Client Info | Rogue AP | Log

System Activity: **Enable** | Wireless Activity: **Enable** | Notice: **Enable**

Remote Syslog Status:
Remote Syslog Status Server IP: 0 . 0 . 0 . 0

Time	Type	Message
Uptime 0 day 00:02:54	SYS	--Web login success from 192
Uptime 0 day 00:00:06	WIRELESS	--WLAN1 Normal AP ready
Uptime 0 day 00:00:01	SYS	--AP cold start with f/w versio

Log | Clear

SMTP Setting

SMTP Server / IP address:

SMTP Sender:

SMTP Recipient:

Check All | Clear Checks | Refresh | Apply | Open | Save | Exit

Remote Syslog Status: Check this option to enable the log and the Remote Syslog Status Server IP.

System Activity: Select **Enable** to allow the logging of system actions, such as logging a firmware upgrade.

Wireless Activity: Select **Enable** to allow the logging of any wireless clients that connect to the AP.

Notice: Select **Enable** to allow all other information to be logged.

Remote Syslog Status Server IP: If you require more space to hold your logs, please provide the IP address of the Server that will store your logs. The embedded memory can only have up to 300 logs.

Device Configuration > Log (continued)

SMTP:	Check the box to enable SMTP.
SMTP Server / IP Address:	Enter the IP address of the SMTP server.
SMTP Sender:	Enter the e-mail address of the SMTP sender.
SMTP Recipient:	Enter the e-mail address of the SMTP recipient.

Device Configuration > Multi-SSID

Device Configuration

Security | Filter | AP Mode | DHCP Server | Client Info | Rogue AP | Log | **Multi-SSID** | SNTP

Enable Multi-SSID Enable VLAN State

Multi-SSID Setting

Band: 802.11g SSID: dlink7 VLAN ID: 1

MSSID Index: **MSSID6** Security: WPA-Auto-Personal

SSID Broadcast: Enable WMM: Enable

PassPhrase Setting

Cipher Type: Auto Group Key Update Interval (300- 9999999): 1800

PassPhrase: (8 - 63 chars)

RADIUS Server: 0 . 0 . 0 . 0 Accounting Mode: Disable

RADIUS Port: 1812 (1-65535) Accounting Server: 0 . 0 . 0 . 0

RADIUS Secret: Accounting Port: 1813

Save

MSSID Index	SSID	Band	Encryption	VLAN ID
Primary	dlink	11g	None	OFF
MSSID1	dlink2	11g	Shared	OFF
MSSID2	dlink3	11g	WPA-Personal	OFF
MSSID3	dlink4	11g	WPA2-Personal	OFF
MSSID4	dlink5	11g	Open	OFF
MSSID5	dlink6	11g	Shared	OFF
MSSID6	dlink7	11g	WPA-Auto-Personal	OFF
MSSID7	dlink8	11g	None	OFF

Delete

Check All Clear Checks Refresh Apply Open Save Exit

The DWL-3260AP offers configuration using Multiple SSIDs, allowing for a virtually segregated station by sharing the same channel. One primary SSID can be associated with up to 7 guest SSIDs. Because guest SSIDs cannot be scanned by site survey tools, users cannot associate with guest SSIDs unless they know the exact SSID and security setting. The VLAN function can be enabled for both the primary SSID and the guest SSID.

Click **Save** to add the MSSID setting to the table below. Highlight and click **Delete** to remove the MSSID from the table.

Device Configuration > SNTP

The screenshot shows a 'Device Configuration' window with a blue title bar and a menu bar containing 'Filter', 'AP Mode', 'DHCP Server', 'Client Info', 'Rogue AP', 'Log', 'Multi-SSID', 'SNTP', and 'SSL'. The 'SNTP' tab is selected. The window is divided into two main sections: 'SNTP/NTP Information' and 'SNTP/NTP Setting'.
In the 'SNTP/NTP Information' section, there are three input fields: 'SNTP/NTP Server IP' (empty), 'SNTP/NTP Time Zone' (set to '(GMT) Greenwich Mean Time : Dublin, Edinburgh, Lisbon, London'), and 'Local Time' (empty).
In the 'SNTP/NTP Setting' section, there are three controls: 'SNTP/NTP Server IP' (a dotted IP address field showing '0 . 0 . 0 . 0'), 'SNTP/NTP Time Zone' (a drop-down menu set to '(GMT) Greenwich Mean Time : Dublin, Edinburgh, Lisbon, London'), and 'Daylight Save Time' (a drop-down menu set to 'Disable').
At the bottom of the window, there is a row of buttons: 'Check All', 'Clear Checks', 'Refresh', 'Apply', 'Open', 'Save', and 'Exit'.

SNTP/NTP Information: The time server IP address, time zone, and the local time will be displayed here.

Server IP Address: Enter the IP address of a SNTP/NTP server.

Time Zone: Select your time zone from the drop-down menu.

Daylight Saving Time: Select Enable or Disable daylight savings time from the drop-down menu.

Device Configuration > SSL

Device Configuration

AP Mode | DHCP Server | Client Info | Rogue AP | Log | Multi-SSID | SNTP | SSL

Update SSL Certification From Local Hard Drive

FTP Server: . 0 . 0 . 0

FTP User Name:

FTP Pass Word:

FTP Certificate File Name:

FTP Key File Name: Upload

Upload Result:

Check All | Clear Checks | Refresh | Apply | Open | Save | Exit

Upload SSL Certification: Enter the FTP server information to properly locate the SSL Certification file on your FTP server. After selecting and opening the file, click **Upload** to upload the file to the DWL-3260AP.

FTP Server: Enter the IP address of the FTP server.

FTP User Name: Enter the FTP user name.

FTP Password: Enter the password for the FTP user name.

FTP Certificate File Name: Enter the FTP certificate file name.

FTP Key File Name: Enter the FTP key file name.

Upload: Click **Upload** to load the settings.

Configuration Files

The DWL-3260AP allows you to save the device settings to a configuration file. To save a configuration file follow these steps:

- Select a device from the Device List on the main screen of the AP Manager.
- Click the device configuration button.
- Click the Save button after you have all the settings as you want them.
- A popup window will appear prompting you for a file name and location. Enter the file name, choose a file destination, and click Save.

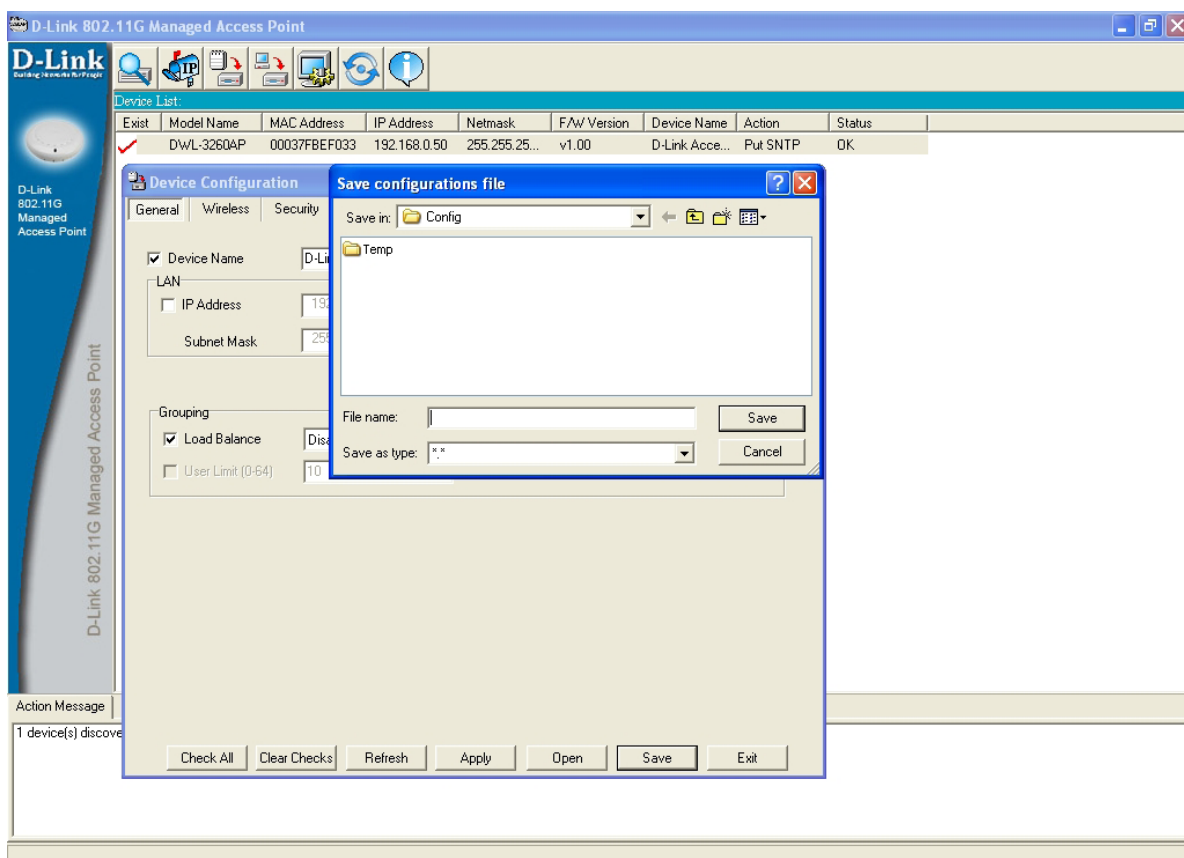
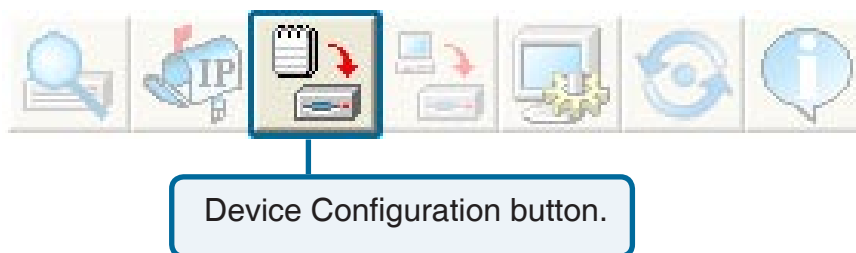

To load a previously saved configuration file, follow these steps:

- Select a device from the Device List on the main screen of the AP Manager.
- Click the device configuration button.
- Click the **Open** button.
- A popup window will appear prompting you to locate the configuration file. Locate the file and click **Open**.
- The configuration file is loaded into the AP Manager but has not actually been written to the device(s). If you want to use the newly loaded configuration for the selected device(s), click **Apply** and the configuration settings will be written to the device(s).

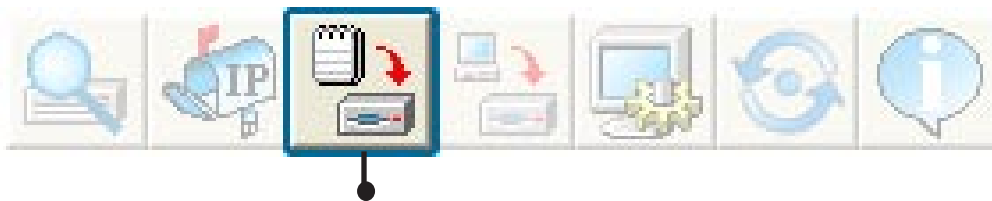

Device Configuration button.

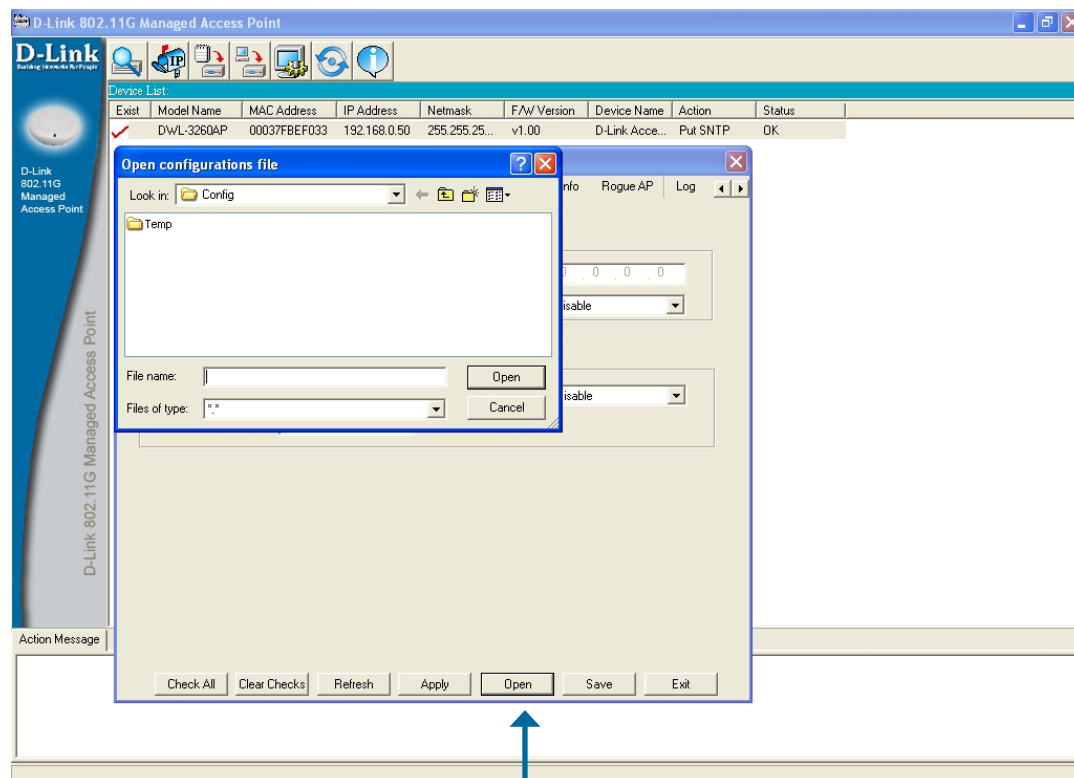

You must always click **Apply** in the Configuration window if you want the settings to take effect.

Firmware



You can upgrade the firmware by clicking on this button after selecting the device(s).

To upgrade the firmware:

- Download the latest firmware upgrade from <http://support.dlink.com> to an easy to find location on your hard drive.
- Click on the firmware button as shown above.
- A popup window will appear. Locate the firmware upgrade file and click **Open**.

IMPORTANT! DO NOT DISCONNECT POWER FROM THE UNIT WHILE THE FIRMWARE IS BEING UPGRADED.

System Settings

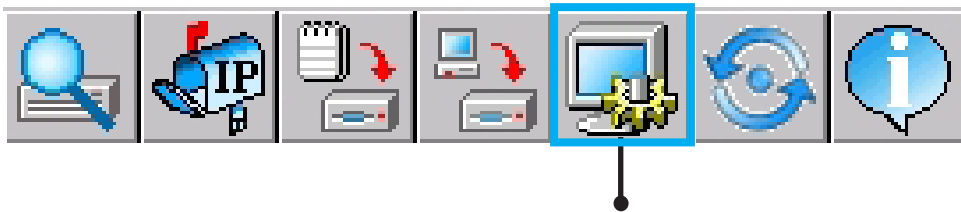

You can customize the basic System Settings for the DWL-3260AP by clicking on this button.

The screenshot shows the D-Link 802.11G Managed Access Point web interface. A table lists the device details, and a 'System Setting' dialog box is open over it.

Exist	Model Name	MAC Address	IP Address	Netmask	F/W Version	Device Name	Action	Status
✓	DWL-3260AP	00037FBEF033	192.168.0.50	255.255.25...	v1.00	D-Link Acce...	Put SNMP	OK

System Setting

Access Password:

Setting Timeout (s):

Reboot Time (s):

Configuration Upload Time (s):

Configuration Download Time (s):

Configuration Flash Update Time (s):

Factory Reset Time (s):

F/W Download Time (s):

F/W Flash Update Time (s):

Timing Tolerance (s):

Discovery Timeout (s):

Discovery Packets Number:

Site Survey GetTime(s):

Client Info GetTime(s):

Auto Refresh:

Buttons: Default, OK, Cancel

Action Message: 1 device(s) discovered.

- **Access Password:** This sets the admin password for the selected device(s).
- **Auto Refresh:** This setting allows you to enable auto refreshing of the network device list. By default this option is disabled. If you choose to enable it, you must enter the refresh interval in seconds.

All other settings on this screen should be left at the default setting.

Refresh



Click on this button to **refresh the list of devices** available on the network.

Devices with a check mark next to them are still available on the network. Devices with an X are no longer available on the network.

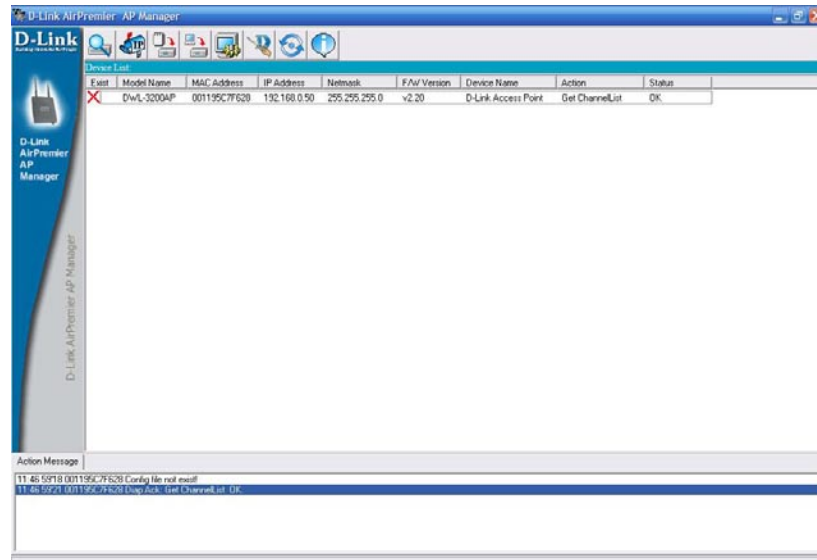

About



Click on this button to view the version of AP Manager.

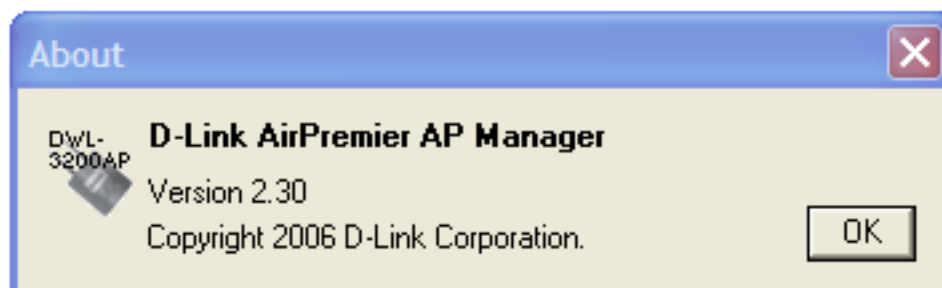

Networking Basics

Using the Network Setup Wizard in Windows® XP

In this section you will learn how to establish a network at home or work, using **Microsoft Windows® XP**.

Note: Please refer to websites such as <http://www.homenethelp.com> and <http://www.microsoft.com/windows2000> for information about networking computers using Windows® 2000.

Go to **Start>Control Panel>Network Connections**
Select **Set up a home or small office network**



When this screen appears, click **Next**.

Please follow all the instructions in this window:

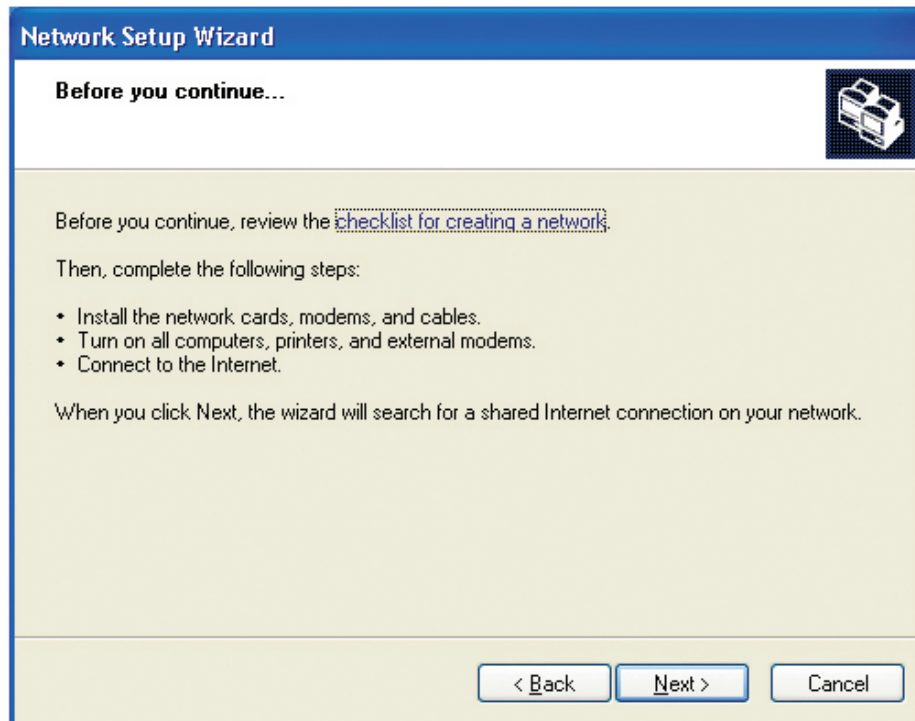

Click **Next**.

In the following window, select the best description of your computer. If your computer connects to the internet through a gateway/router, select the second option as shown.

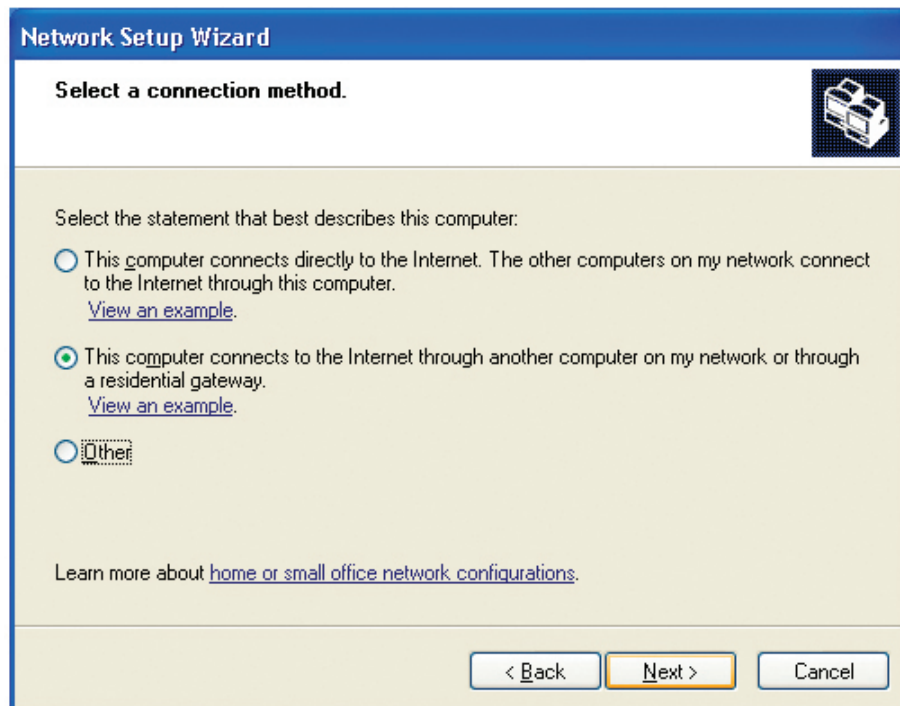

Click **Next**.

Enter a **Computer description** and a **Computer name** (optional).

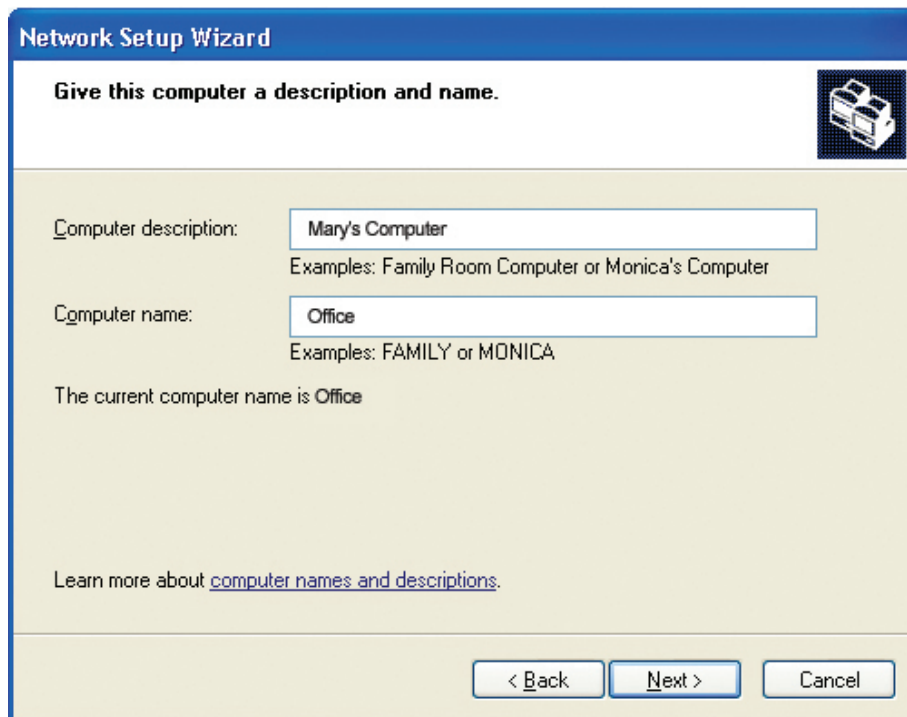

The screenshot shows the 'Network Setup Wizard' dialog box. The title bar reads 'Network Setup Wizard'. The main heading is 'Give this computer a description and name.' with a printer icon in the top right corner. Below the heading, there are two text input fields. The first is labeled 'Computer description:' and contains the text 'Mary's Computer'. Below it, there are examples: 'Examples: Family Room Computer or Monica's Computer'. The second is labeled 'Computer name:' and contains the text 'Office'. Below it, there are examples: 'Examples: FAMILY or MONICA'. Below the input fields, it says 'The current computer name is Office'. At the bottom left, there is a link: 'Learn more about [computer names and descriptions](#)'. At the bottom right, there are three buttons: '< Back', 'Next >', and 'Cancel'.

Click **Next**.

Enter a **Workgroup** name. All computers on your network should have the same **Workgroup name**.

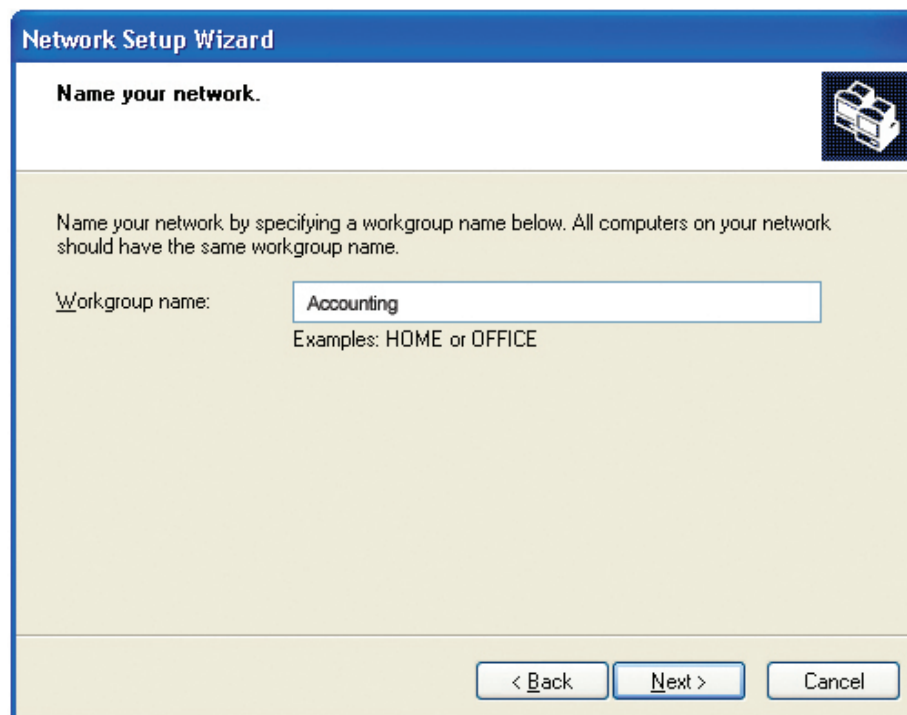

The screenshot shows the 'Network Setup Wizard' dialog box. The title bar reads 'Network Setup Wizard'. The main heading is 'Name your network.' with a printer icon in the top right corner. Below the heading, there is a paragraph: 'Name your network by specifying a workgroup name below. All computers on your network should have the same workgroup name.' Below this, there is a text input field labeled 'Workgroup name:' containing the text 'Accounting'. Below the input field, there are examples: 'Examples: HOME or OFFICE'. At the bottom right, there are three buttons: '< Back', 'Next >', and 'Cancel'.

Click **Next**.

Please wait while the **Network Setup Wizard** applies the changes.

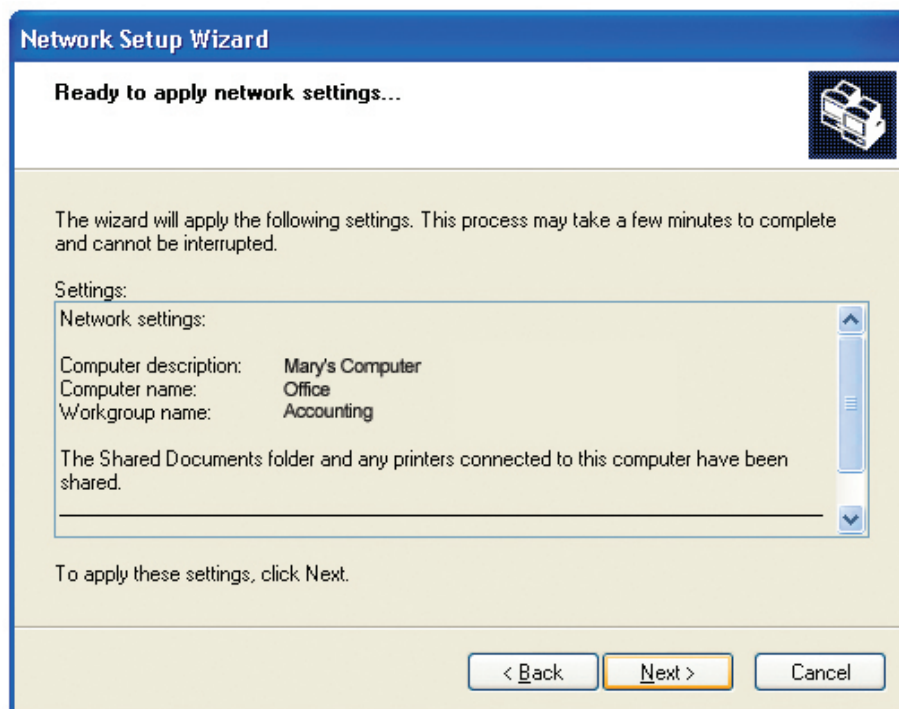

When the changes are complete, click **Next**.

Please wait while the **Network Setup Wizard** configures the computer. This may take a few minutes.

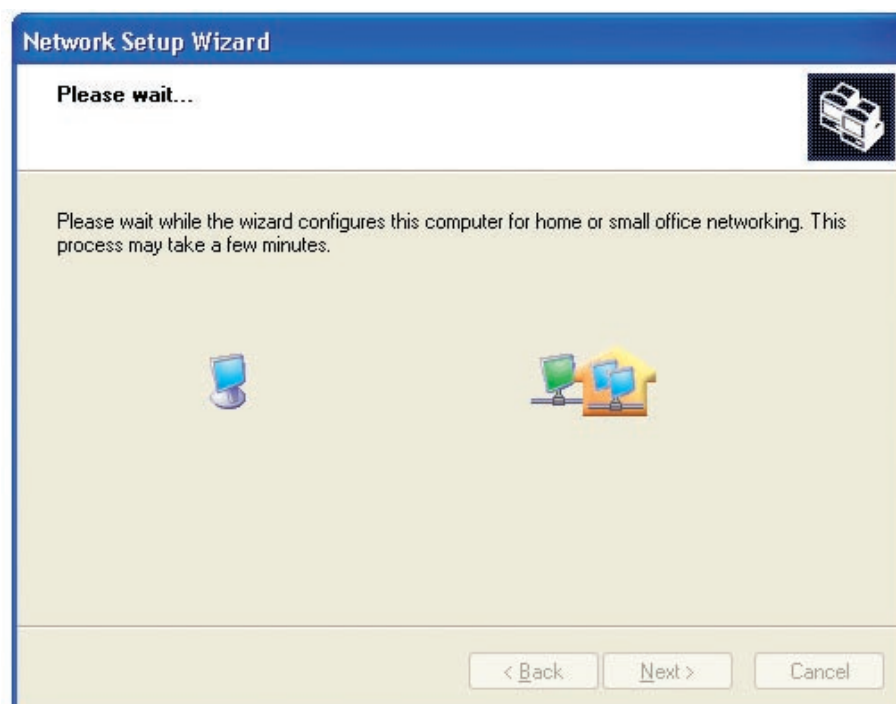

In the window below, select the option that fits your needs. In this example, **Create a Network Setup Disk** has been selected. You will run this disk on each of the computers on your network. Click **Next**.

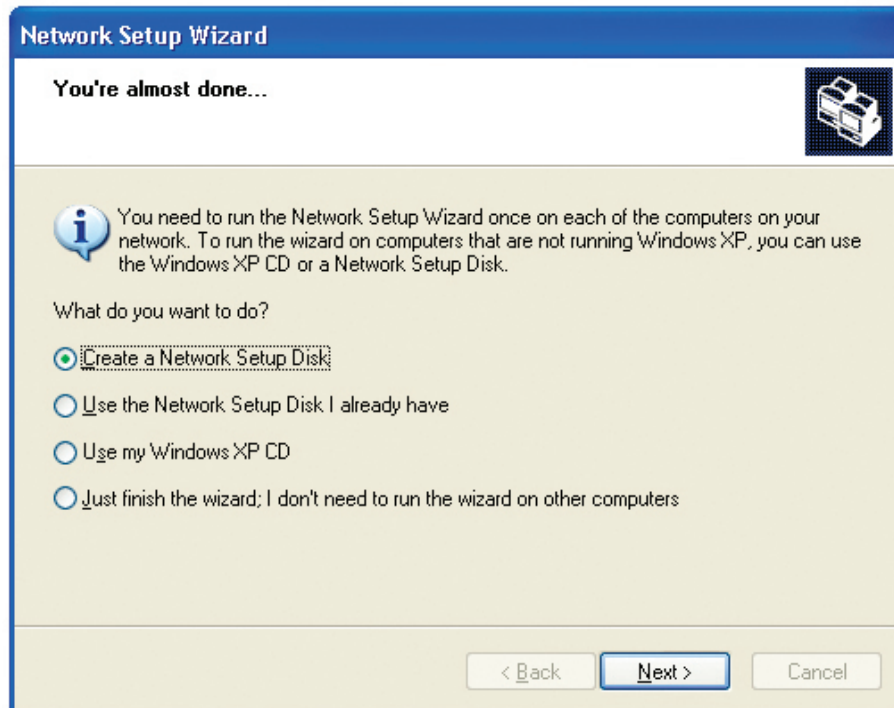

Insert a disk into the Floppy Disk Drive, in this case drive **A**.



Click **Next**.

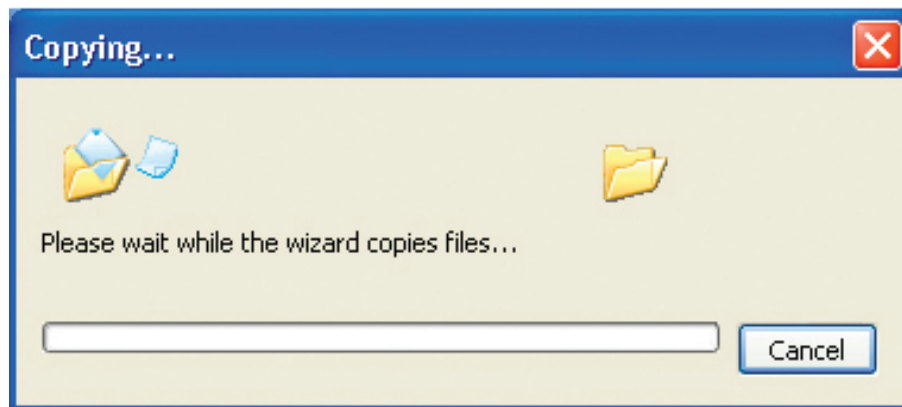

Please read the information under **Here's how** in the screen below. After you complete the **Network Setup Wizard** you will use the **Network Setup Disk** to run the **Network Setup Wizard** once on each of the computers on your network. To continue click **Next**.

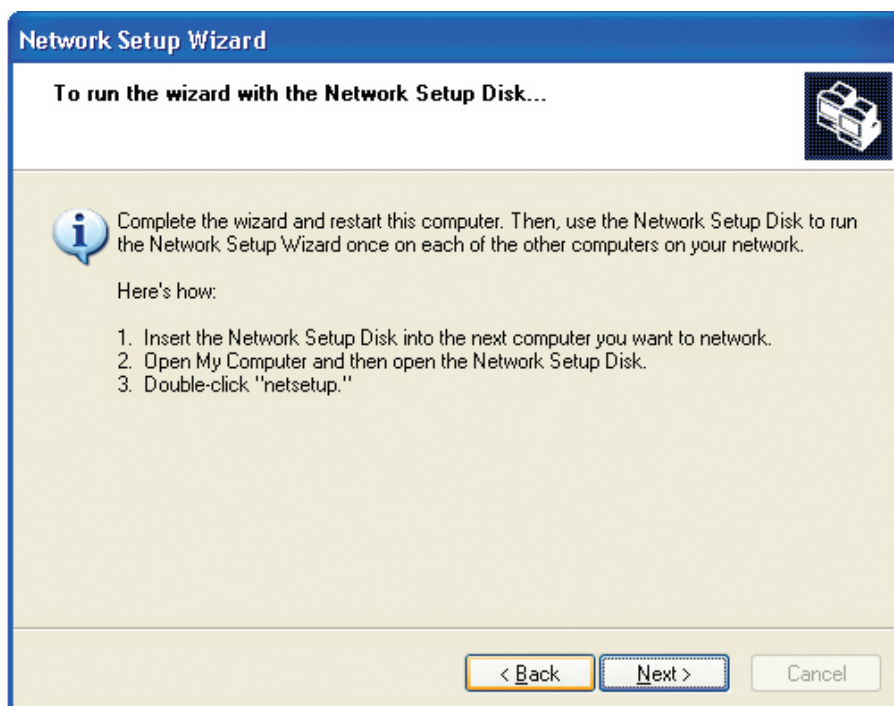

Please read the information on this screen, then click **Finish** to complete the **Network Setup Wizard**.

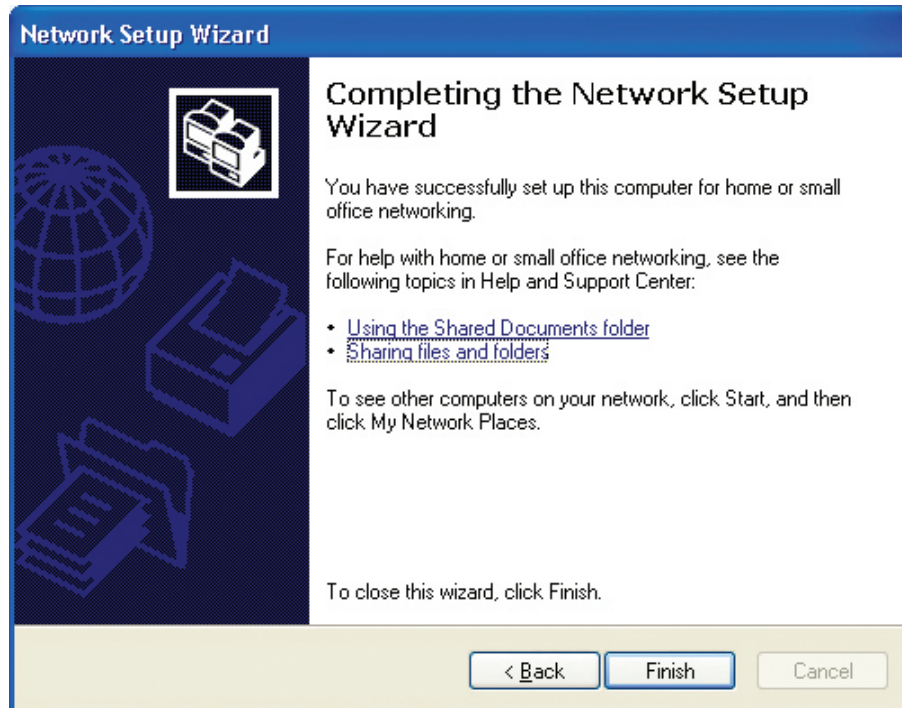

The new settings will take effect when you restart the computer. Click **Yes** to restart the computer.

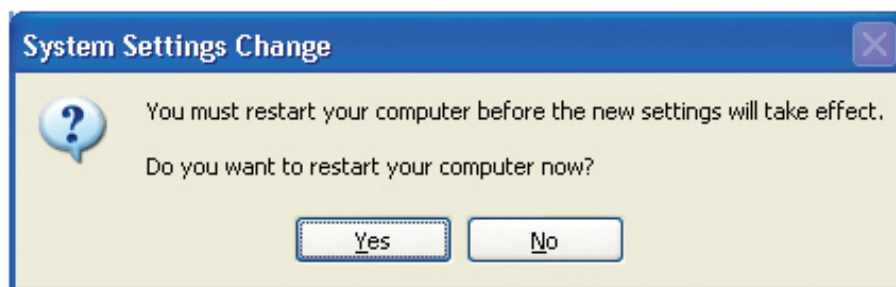

You have completed configuring this computer. Next, you will need to run the **Network Setup Disk** on all the other computers on your network. After running the **Network Setup Disk** on all your computers, your new wireless network will be ready to use.

Naming Your Computer

To name your computer in **Windows® XP**, please follow these directions.

- Click **Start** (in the lower left corner of the screen).
- **Right-click** on **My Computer**.
- Select **Properties** and click.



- Select the **Computer Name Tab** in the System Properties window.
- You may enter a **Computer Description** if you wish; this field is optional.
- To rename the computer and join a domain, Click **Change**.

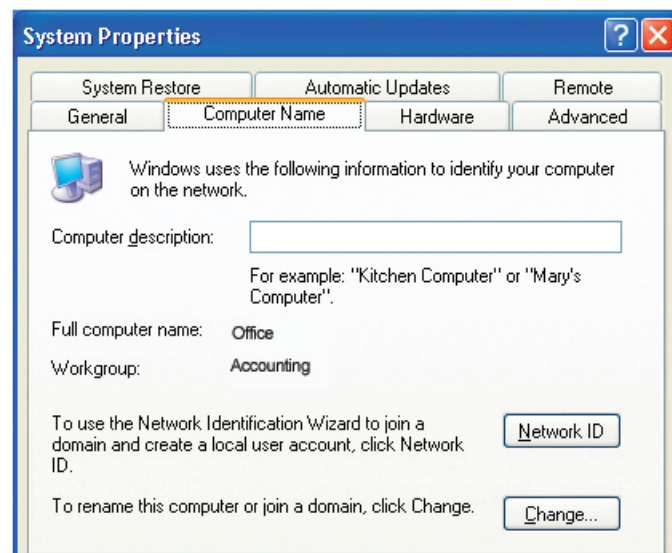

- In this window, enter the **Computer name**.
- Select **Workgroup** and enter the name of the **Workgroup**.
- All computers on your network must have the same **Workgroup** name.
- Click **OK**.

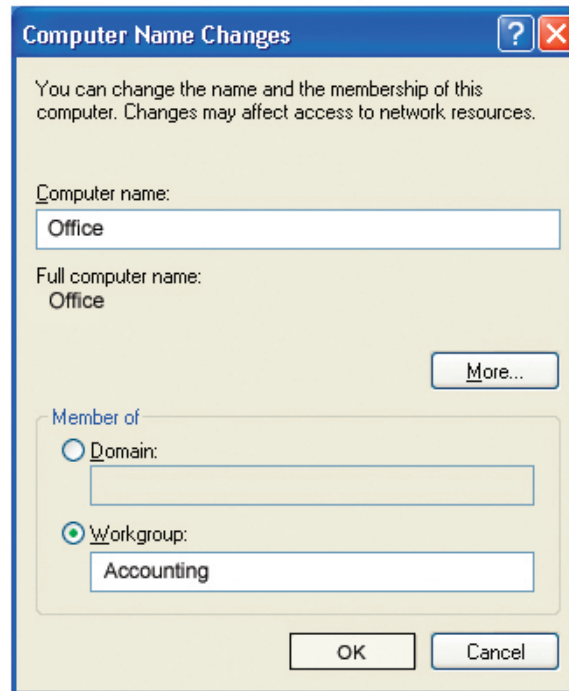

Checking the IP Address in Windows® XP

The wireless adapter-equipped computers in your network must be in the same IP Address range (see Getting Started in this manual for a definition of IP Address Range.) To check on the IP Address of the adapter, please do the following:

- Right-click on the **Local Area Connection icon** in the task bar.
- Click on **Status**.



This window will appear:

- Click the **Support tab**.
- Click **Close**.

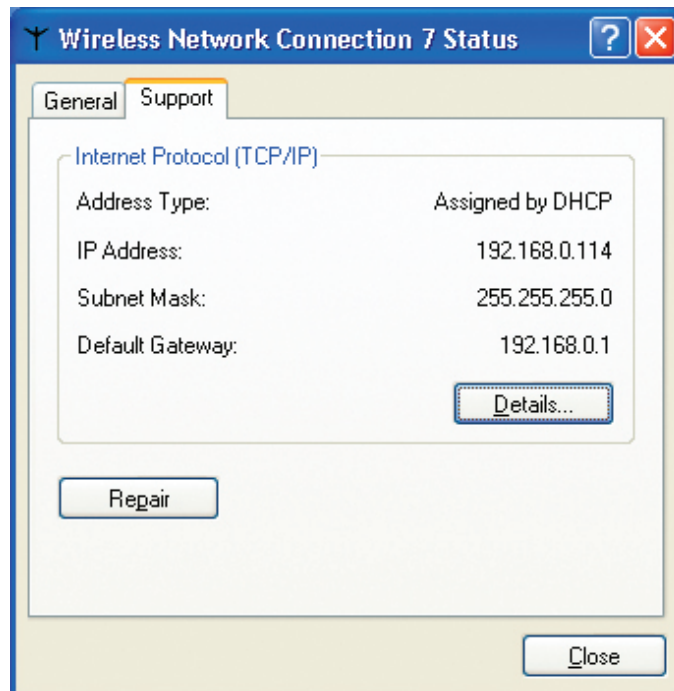

Assigning a Static IP Address in Windows® XP/2000

Note: DHCP-enabled routers will automatically assign IP addresses to the computers on the network, using DHCP (Dynamic Host Configuration Protocol) technology. If you are using a DHCP-capable router you will not need to assign static IP addresses.

If you are not using a DHCP capable router, or you need to assign a static IP address, please follow these instructions:

- Go to **Start**.
- Double-click on **Control Panel**.

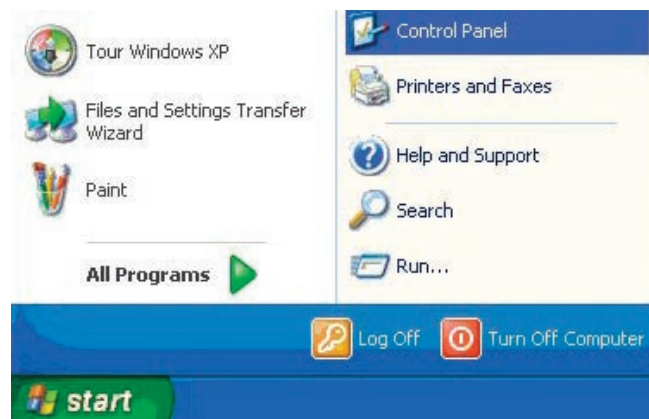

- Double-click on **Network Connections**.

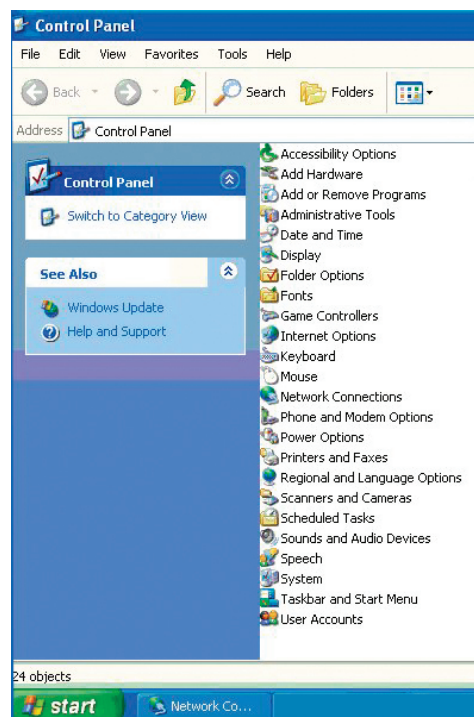

- Right-click on **Local Area Connections**.
- Double-click on **Properties**.

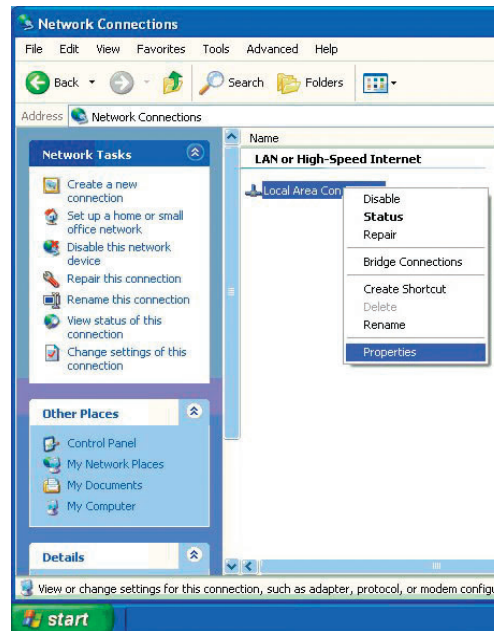

- Click on **Internet Protocol (TCP/IP)**.
- Click **Properties**.
- Input your **IP address and subnet mask**. (The IP addresses on your network must be within the same range. For example, if one computer has an IP address of 192.168.0.2, the other computers should have IP addresses that are sequential, like 192.168.0.3 and 192.168.0.4. The subnet mask must be the same for all the computers on the network.)

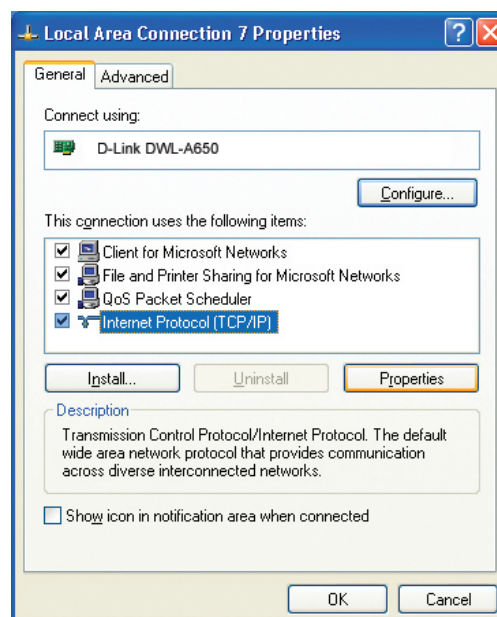

- Input your **DNS server addresses**. (Note: If you are entering a DNS server, you must enter the IP address of the default gateway.)

The DNS server information will be supplied by your ISP (Internet Service Provider.)

- Click **OK**.

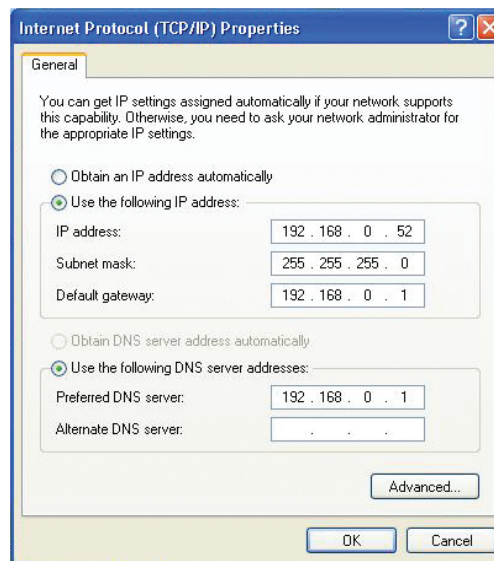

Assigning a Static IP Address in Macintosh® OSX

- Go to the **Apple Menu** and select **System Preferences**.
- Click on **Network**.



- Select **Built-in Ethernet** in the **Show** pull-down menu.
- Select **Manually** in the **Configure** pull-down menu.

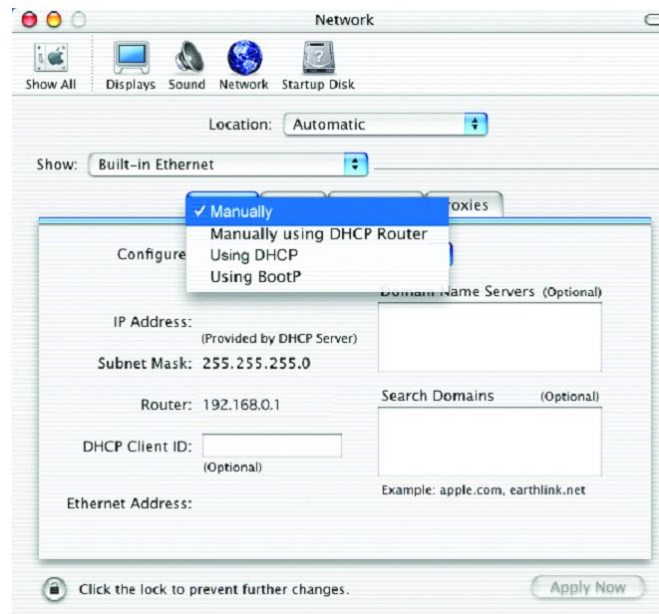

- Input the **Static IP Address**, the **Subnet Mask** and the **Router IP Address** in the appropriate fields.
- Click **Apply Now**.

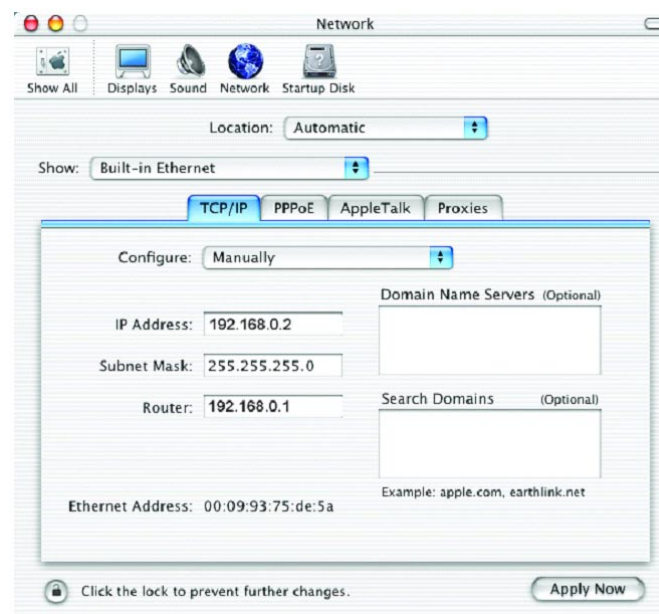

- Go to the **Apple Menu** and select **System Preferences**.
- Click on **Network**.

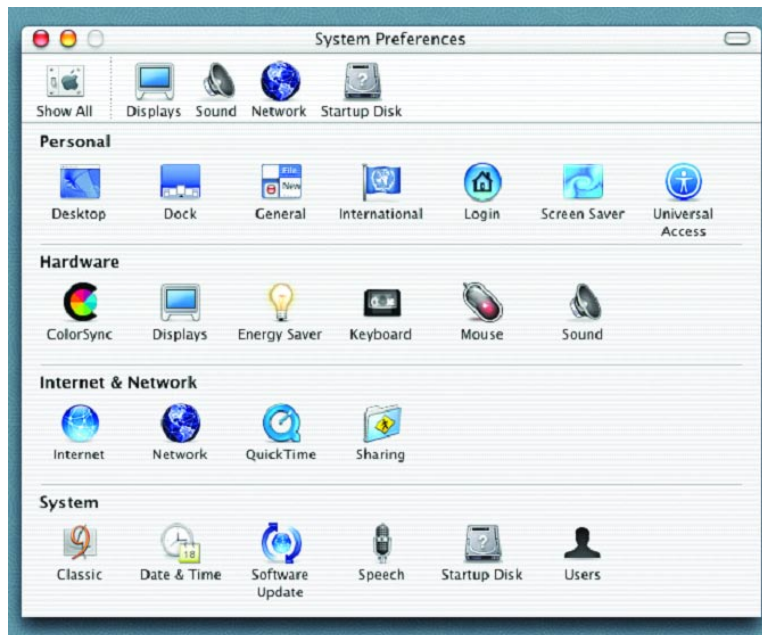

- Select **Built-in Ethernet** in the **Show** pull-down menu.
- Select **Using DHCP** in the **Configure** pull-down menu.

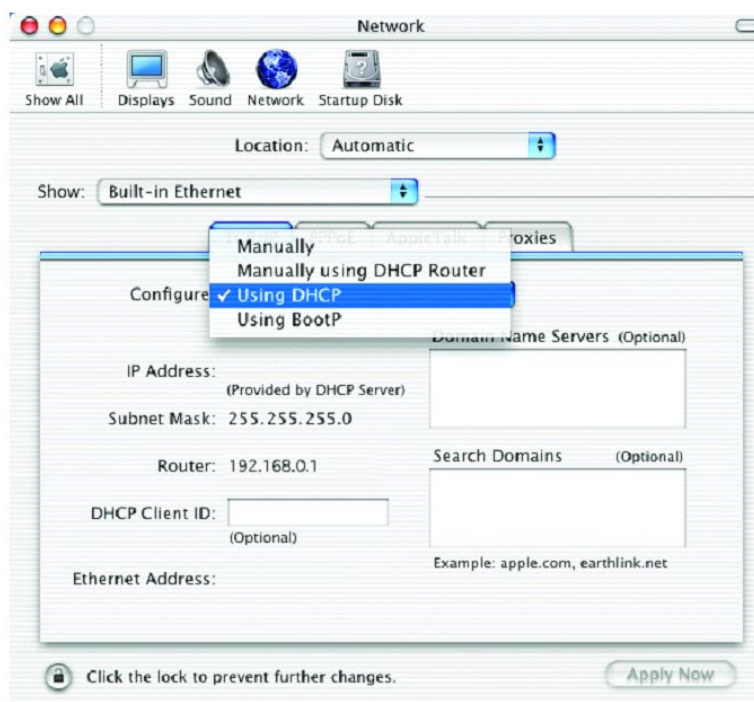

- Click **Apply Now**.
- The **IP Address**, **Subnet mask**, and the **Router's IP Address** will appear in a few seconds.

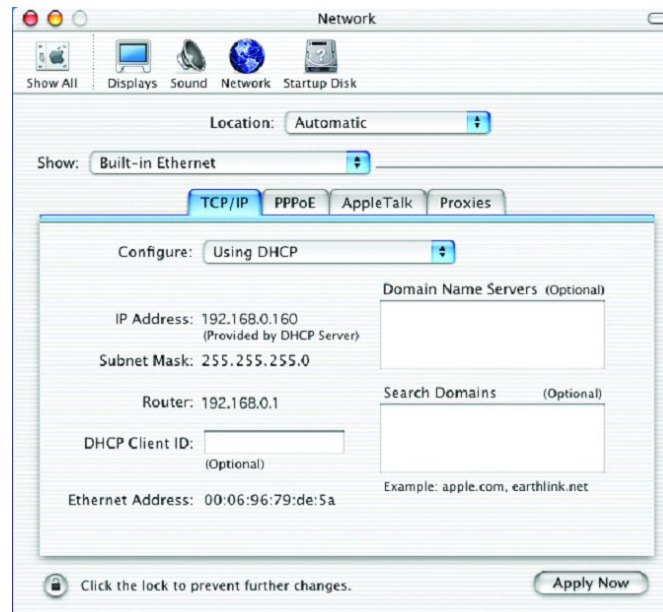

Checking the Wireless Connection by Pinging in Windows[®] XP and 2000

Go to **Start > Run > type cmd**. A window similar to this one will appear. Type **ping xxx.xxx.xxx.xxx**, where **xxx** is the **IP address** of the wireless router or access point. A good wireless connection will show four replies from the wireless router or access point, as shown.

```
EX F:\WINDOWS\System32\cmd.exe
Microsoft Windows XP [Version 5.1.2600]
(C) Copyright 1985-2001 Microsoft Corp.

F:\Documents and Settings\lab4>ping 192.168.0.50

Pinging 192.168.0.50 with 32 bytes of data:

Reply from 192.168.0.50: bytes=32 time=5ms TTL=30
Reply from 192.168.0.50: bytes=32 time=64ms TTL=30
Reply from 192.168.0.50: bytes=32 time=3ms TTL=30
Reply from 192.168.0.50: bytes=32 time=17ms TTL=30

Ping statistics for 192.168.0.50:
    Packets: Sent = 4, Received = 4, Lost = 0 (0% loss),
Approximate round trip times in milli-seconds:
    Minimum = 3ms, Maximum = 64ms, Average = 22ms

F:\Documents and Settings\lab4>_
```

Troubleshooting

This Chapter provides solutions to problems that can occur during the installation and operation of the DWL-3260AP Managed Wireless Access Point. We cover various aspects of the network setup, including the network adapters. Please read the following if you are having problems.

Note: It is recommended that you use an Ethernet connection to **configure the DWL-3260AP**.

1. The computer used to configure the DWL-3260AP cannot access the Configuration menu.

- Check that the **Ethernet LED** on the DWL-3260AP is **ON**. If the **LED** is not **ON**, check that the cable for the Ethernet connection is securely inserted.
- Check that the Ethernet Adapter is working properly. Please see item 3 (**Check that the drivers for the network adapters are installed properly**) in this Troubleshooting section to check that the drivers are loaded properly.
- Check that the **IP address** is in the same range and subnet as the DWL-3260AP. Please see **Checking the IP Address in Windows® XP** in the Networking Basics section of this manual.

Note: The IP address of the DWL-3260AP is 192.168.0.50. All the computers on the network must have a unique IP address in the same range, e.g., 192.168.0.x. Any computers that have identical IP addresses will not be visible on the network. They must all have the same subnet mask, e.g., 255.255.255.0.

- Do a **Ping test** to make sure that the DWL-3260AP is responding. Go to **Start>Run>Type Command>Type ping 192.168.0.50**. A successful ping will show four replies.

Note: If you have changed the default IP address, make sure to ping the correct IP address assigned to the DWL-3260AP.

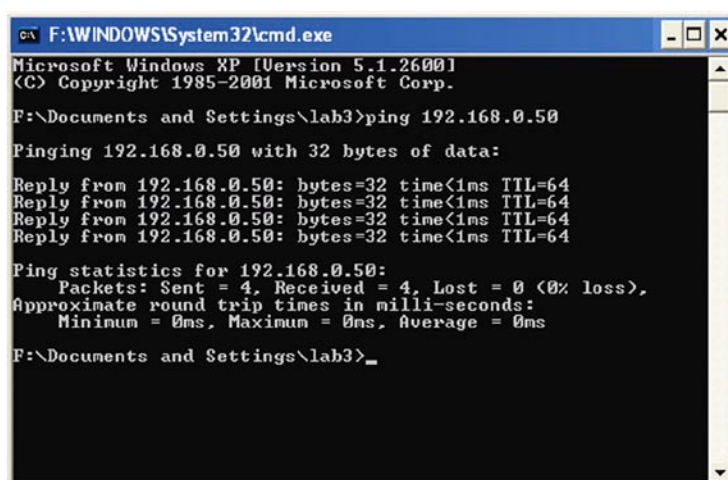

```
ca F:\WINDOWS\System32\cmd.exe
Microsoft Windows XP [Version 5.1.2600]
(C) Copyright 1985-2001 Microsoft Corp.

F:\Documents and Settings\lab3>ping 192.168.0.50

Pinging 192.168.0.50 with 32 bytes of data:

Reply from 192.168.0.50: bytes=32 time<1ms TTL=64
Reply from 192.168.0.50: bytes=32 time<1ms TTL=64
Reply from 192.168.0.50: bytes=32 time<1ms TTL=64
Reply from 192.168.0.50: bytes=32 time<1ms TTL=64

Ping statistics for 192.168.0.50:
    Packets: Sent = 4, Received = 4, Lost = 0 (0% loss),
    Approximate round trip times in milli-seconds:
        Minimum = 0ms, Maximum = 0ms, Average = 0ms

F:\Documents and Settings\lab3>_
```

2. The wireless client cannot access the Internet in the Infrastructure mode.

Make sure the wireless client is associated and joined with the correct access point. To check this connection: **Right-click** on the **Local Area Connection icon** in the taskbar > select **View Available Wireless Networks**. The **Connect to Wireless Network** screen will appear. Please make sure you have selected the correct available network, as shown in the illustrations below.



- Check that the **IP address** assigned to the wireless adapter is within the same **IP address range** as the access point and gateway. *Since the DWL-3260AP has an IP address of 192.168.0.50, wireless adapters must have an IP address in the same range, e.g., 192.168.0.x. Each device must have a unique IP address; no two devices may have the same IP address. The subnet mask must be the same for all the computers on the network.)* To check the IP address assigned to the wireless adapter, **double-click** on the **Local Area Connection icon** in the taskbar > select the **Support tab** and the **IP address** will be displayed. *Please refer to **Checking the IP Address** in the **Networking Basics** section of this manual.)*
- If it is necessary to assign a **Static IP Address** to the wireless adapter, please refer to the appropriate section in **Networking Basics**. If you are entering a **DNS Server address** you must also enter the **Default Gateway Address**. *(Remember that if you have a DHCP-capable router, you will not need to assign a static IP address. See **Networking Basics: Assigning a Static IP Address**.)*

3. Check that the drivers for the network adapters are installed properly.

You may be using different network adapters than those illustrated here, but this procedure will remain the same, regardless of the type of network adapters you are using.

- Go to **Start > My Computer > Properties**.



- **Select the Hardware Tab.**
- **Click Device Manager.**

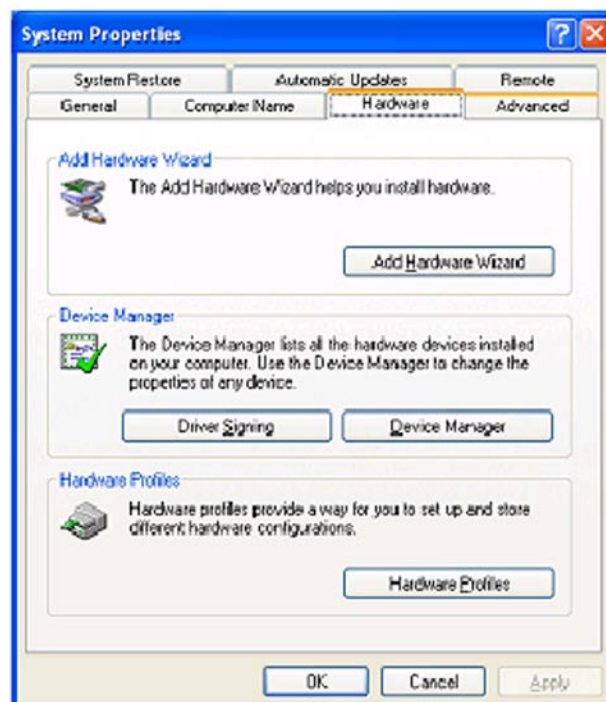

- Double-click on **Network Adapters**.
- Right-click on **D-Link AirPlus DWL-G650 Wireless Cardbus Adapter**. (In this example we use the DWL-G650; you may be using other network adapters, but the procedure will remain the same.)
- Select **Properties** to check that the drivers are installed properly.

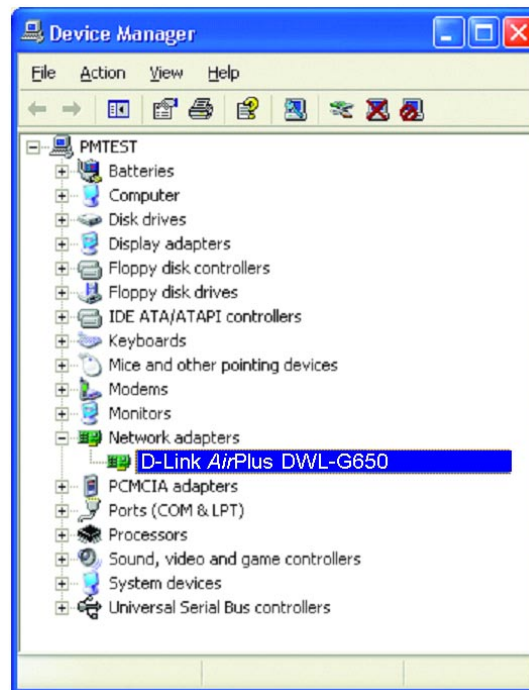

- Look under **Device Status** to check that the device is working properly.
- Click **OK**.

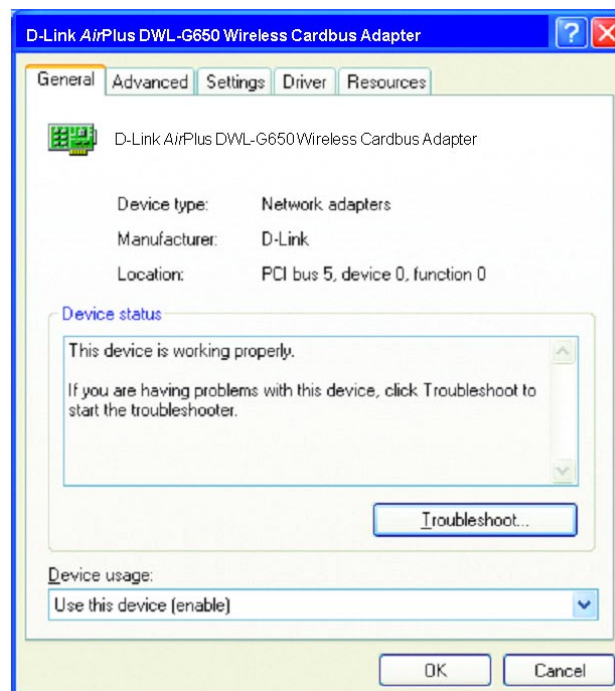

4. What variables may cause my wireless products to lose reception?

D-Link products let you access your network from virtually anywhere you want. However, the positioning of the products within your environment will affect the wireless range. Please refer to **Installation Considerations** in the **Wireless Basics** section of this manual for further information about the most advantageous placement of your D-Link wireless products.

5. Why does my wireless connection keep dropping?

- Antenna Orientation- Try different antenna orientations for the DWL-3260AP. Try to keep the antenna at least 6 inches away from the wall or other objects.
- If you are using 2.4GHz cordless phones, X-10 equipment or other home security systems, ceiling fans, and lights, your wireless connection will degrade dramatically or drop altogether. Try changing the channel on your router, access point and wireless adapter to a different channel to avoid interference.
- Keep your product away (at least 3-6 feet) from electrical devices that generate RF noise, like microwaves, monitors, electric motors, etc.

6. Why can't I get a wireless connection?

If you have enabled encryption on the DWL-3260AP, you must also enable encryption on all wireless clients in order to establish a wireless connection.

- Make sure that the SSID on the router and the wireless client are exactly the same. If they are not, wireless connection will not be established.
- Move the DWL-3260AP and the wireless client into the same room and then test the wireless connection.
- Disable all security settings.
- Turn off your DWL-3260AP and the client. Turn the DWL-3260AP back on again, and then turn on the client.
- Make sure that all devices are set to Infrastructure mode.
- Check that the LED indicators are indicating normal activity. If not, check that the AC power and Ethernet cables are firmly connected.
- Check that the IP address, subnet mask, gateway and DNS settings are correctly entered for the network.
- If you are using 2.4GHz cordless phones, X-10 equipment or other home security systems, ceiling fans, and lights, your wireless connection will degrade dramatically or drop altogether. Try changing the channel on your DWL-3260AP, and on all the devices in your network to avoid interference.
- Keep your product away (at least 3-6 feet) from electrical devices that generate RF noise, like microwaves, monitors, electric motors, etc.

7. I forgot my encryption key.

- Reset the DWL-3260AP to its factory default settings and restore the other devices on your network to their default settings. You may do this by pressing the Reset button on the back of the unit. You will lose the current configuration settings.

Product Specifications

Standards

- IEEE 802.11b
- IEEE 802.11g
- IEEE 802.3
- IEEE 802.3u
- IEEE 802.3af

Data Rates

- For 802.11g:
108, 54, 48, 36, 24, 18, 12, 9 and 6Mbps
- For 802.11b:
11, 5.5, 2 and 1Mbps

Wireless Frequency Range

2.4GHz to 2.4835GHz

Antenna

- Internal omni-directional antenna
- Reverse SMA connector for optional external antenna

Wireless Operating Range *

802.11g (full power with 5dBi gain diversity dipole antennas)

- Indoors:

- 30m (98ft) @ 54Mbps
- 34m (112ft) @ 48Mbps
- 39m (128ft) @ 36Mbps
- 47m (154ft) @ 24Mbps
- 56m (184ft) @ 18Mbps
- 66m (217ft) @ 12Mbps
- 79m (259ft) @ 9Mbps
- 99m (325ft) @ 6Mbps

- Outdoors:

- 112m (367ft) @ 54Mbps
- 250m (820ft) @ 18Mbps
- 500m (1640ft) @ 6Mbps

* Environmental factors may adversely affect operation range.

Radio and Modulation Type

- For 802.11b:

DSSS:

- DBPSK @ 1Mbps
- DQPSK @ 2Mbps
- CCK @ 5.5 and 11Mbps

- For 802.11g:

OFDM:

- BPSK @ 6 and 9Mbps
- QPSK @ 12 and 18Mbps
- 16QAM @ 24 and 36Mbps
- 64QAM @ 48 and 54Mbps

DSSS:

DBPSK @ 1Mbps

DQPSK @ 2Mbps

CCK @ 5.5 and 11Mbps

Transmit Output Power

- For 802.11b:

100mW (20dBm)

50mW (17dBm)

30mW (15dBm)

20mW (13dBm)

10mW (10dBm)

5mW (7dBm)

1mW (0dBm)

- For 802.11g:

100mW (20dBm)

63mW (18dBm)

30mW (15dBm)

20mW (13dBm)

10mW (10dBm)

5mW (7dBm)

1mW (0dBm)

EIRP Total Output Power

(With 5dBi Antennas)

- For 802.11b:

400mW (26dBm)

160mW (22dBm)

100mW (20dBm)

63mW (18dBm)

32mW (15dBm)

16mW (12dBm)

3mW (5dBm)

- For 802.11g:

400mW (26dBm)

200mW (23dBm)

100mW (20dBm)

63mW (18dBm)

32mW (15dBm)

16mW (12dBm)

3mW (5dBm)

Receiver Sensitivity

- For 802.11b:

1Mbps: -94dBm

2Mbps: -90dBm

5.5Mbps: -89dBm

11Mbps: -85dBm

- For 802.11g:

1Mbps: -94dBm

2Mbps: -90dBm

5.5Mbps: -89dBm

6Mbps: -90dBm

9Mbps: -84dBm

- 11Mbps: -85dBm
- 12Mbps: -82dBm
- 18Mbps: -80dBm
- 24Mbps: -77dBm
- 36Mbps: -73dBm
- 48Mbps: -72dBm
- 54Mbps: -72dBm

Operation Modes

- Access Point
- WDS With AP
- WDS/Bridge (No AP Broadcasting)

Security

- 64-, 128-, 152-bit WEP data encryption
- MAC address filtering
- WPA/WPA2 EAP
- WPA/WPA2 PSK
- 802.1x User Authentication
- AES
- 802.11i-ready
- 802.1Q SSID broadcast enable/disable
- Multiple SSIDs (maximum 8)
- Isolated security for each SSID (different security setting for each SSID)
- Rogue AP detection

VLAN

- 802.1Q VLAN Tagging
- Up to 8 VLANs

Quality of Service

WMM (Wi-Fi Multimedia) certified

Device Management

- Web Browser Interface:
 - HTTP
 - Secure HTTP (HTTPS)
- AP Manager
- SNMP support:
 - D-View module
 - Private MIB
- Command Line Interface:
 - Telnet
 - Secure (SSH) Telnet

Physical & Environmental

=====

LED Diagnostics

- Power
- Status
- Traffic Activity

Operating Voltage

48VDC +/- 10% for PoE

Power Consumption

6.24 watts (130mA) (max.)

Dimensions

- Diameter: 171.97 mm (6.77 inches)

- Height: 48.16 mm (1.90 inches)

Weight

284 grams (0.63 lb)

Operating Temperature

-40 to 60 C (-40 to 140 F)

Storing Temperature

-40 to 65 C (-40 to 149 F)

Operating Humidity

10% to 90% (non-condensing)

Storing Humidity

5% to 95% (non-condensing)

Certifications

- FCC Class B

- CE

- Wi-Fi